

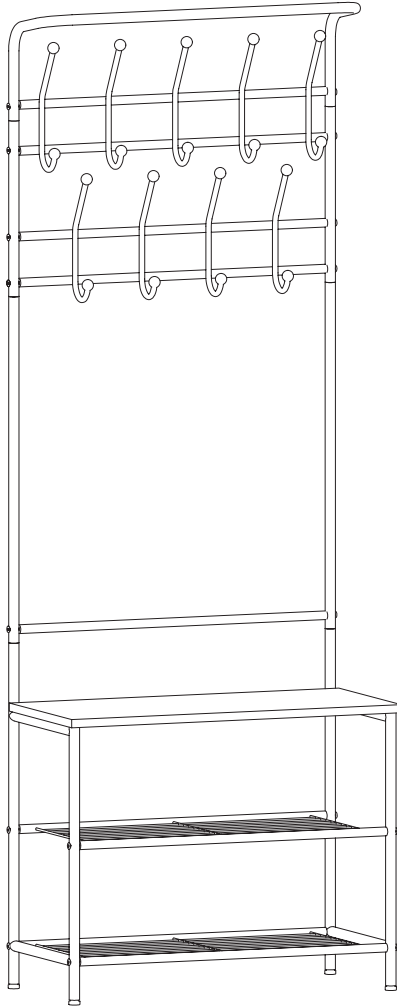

honey•can•do



SHF-03423

**storage valet**  
**valet almacenamiento**  
**voiturier de stockage**





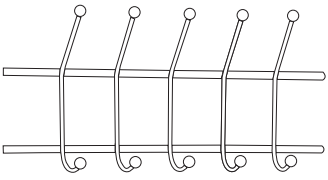
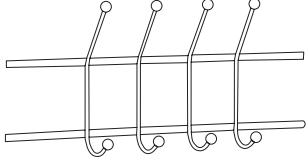
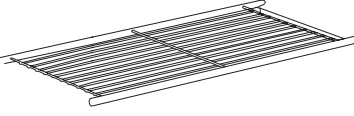
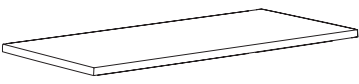

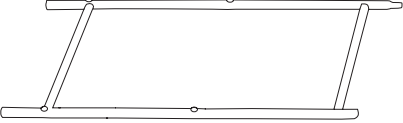
**25.75 in L x 12.25 in W x 70.25 in H / 65.4 cm L x 31.1 cm W x 178.4 cm H**

# PARTS LIST

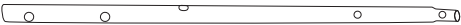
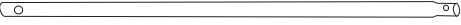
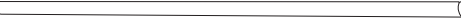
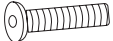
PART/ILLUSTRATION	(QTY) DESCRIPTION
<b>A</b>  A horizontal bar with five vertical hooks hanging from it. Each hook has a circular top and a curved bottom.	(1) 5 hook bar bar 5 gancho bar 5 crochet
<b>B</b>  A horizontal bar with four vertical hooks hanging from it. Each hook has a circular top and a curved bottom.	(1) 4 hook bar barra de 4 ganchos 4 barre de crochet
<b>C</b>  A rectangular wire mesh shelf with a grid pattern.	(2) shelves estantería des étagères
<b>D</b>  A simple, flat rectangular wooden shelf.	(1) wood shelf estante de madera étagère en bois
<b>E</b>  A curved rod with a slight arch, used for hanging items.	(1) curved rod varilla curvada bâtonnet courbée
<b>F</b>  A rectangular frame made of four legs and two horizontal bars, used to support shelves.	(2) shelf frames marcos estanterías cadres d'étagère

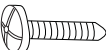
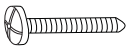
# PARTS LIST

PART/ILLUSTRATION	(QTY)	DESCRIPTION
<b>G</b> 	( 2 )	top bars mejor de bares barreaux supérieurs
<b>H</b> 	( 2 )	middle bars barras centrales barres centrales
<b>I</b> 	( 1 )	back bar barras posterior bar retour
<b>J</b> 	( 18 )	pan head, hex socket screws (M6 x 1 x 30mm)
		cabeza redonda, tornillos hexagonales (M6 x 1 x 30mm) tête cylindrique, vis à six pans creux (M6 x 1 x 30mm)
<b>K</b> 	( 4 )	feet pies pieds
<b>L</b> 	( 2 )	flat head, philips recess, wood screws (M4 x 30mm)
		cabeza plana, receso phillips, tornillos para madera (M4 x 30mm) tête plate, empreinte cruciforme, vis à bois (M4 x 30mm)
<b>M</b> 	( 2 )	flat head, philips recess, wood screws (M4 x 50mm)
		cabeza plana, receso phillips, tornillos para madera (M4 x 50mm) tête plate, empreinte cruciforme, vis à bois (M4 x 50mm)
<b>N</b> 	( 2 )	wall anchors anclajes de pared ancrages muraux
<b>O</b> 	( 1 )	allen wrench llave allen clé allen

# ASSEMBLY

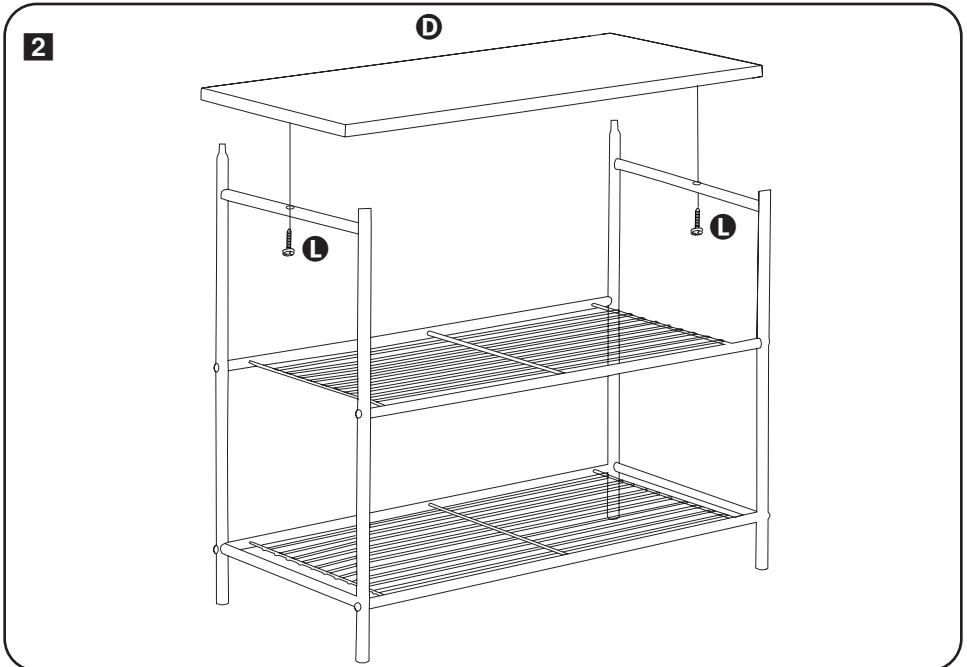
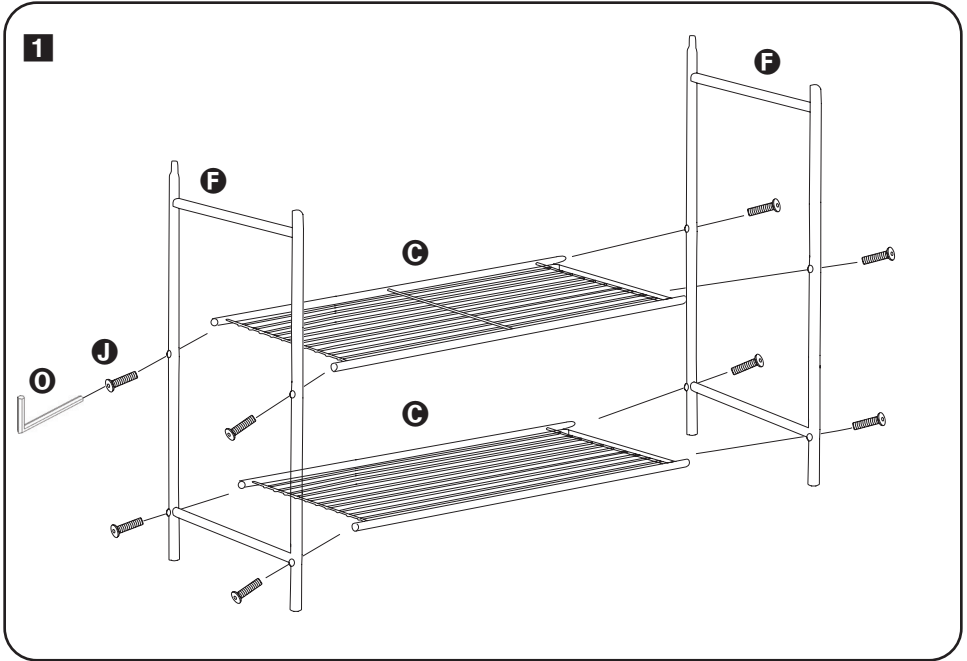

# ASSEMBLY

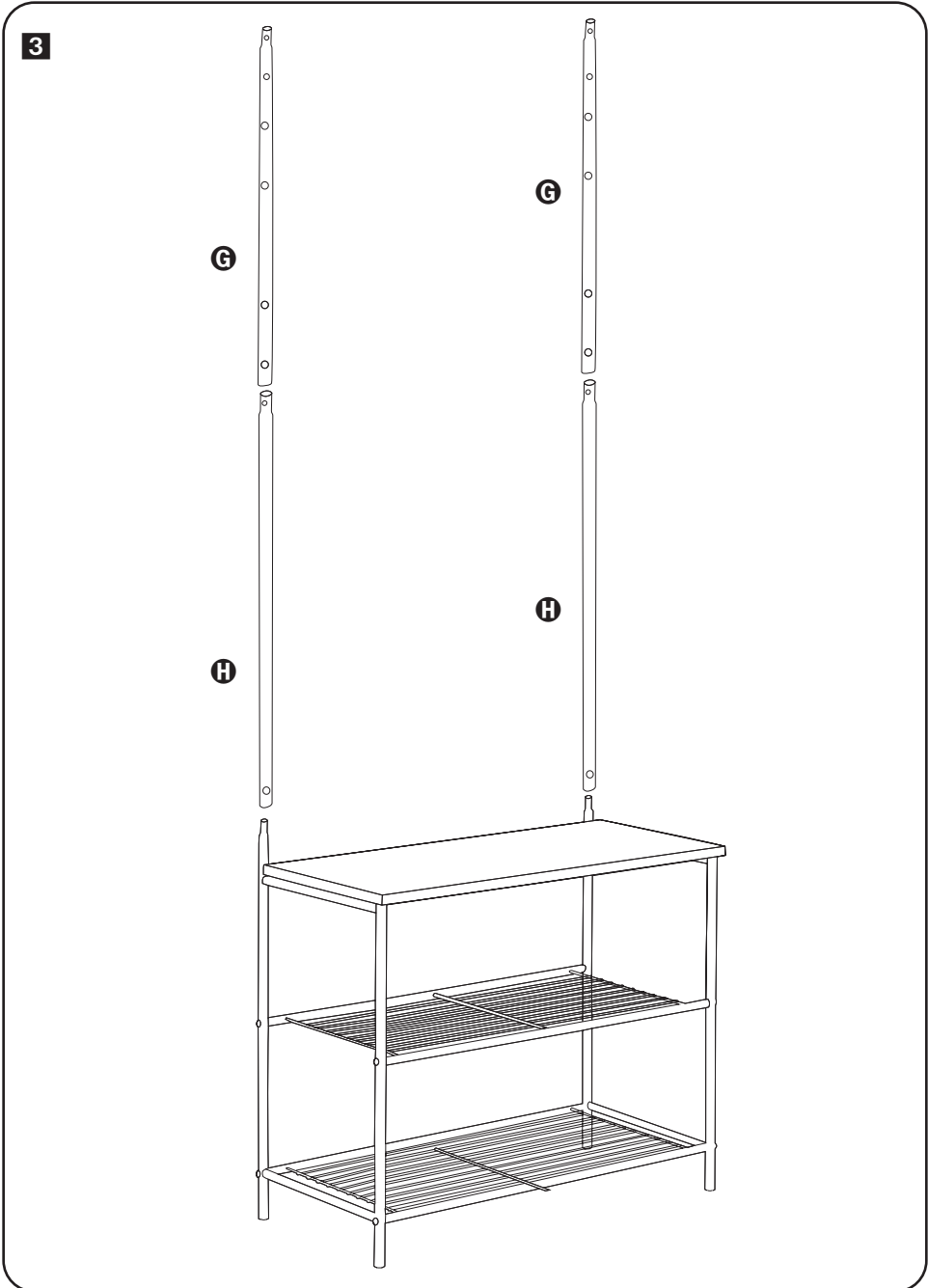

# ASSEMBLY

4

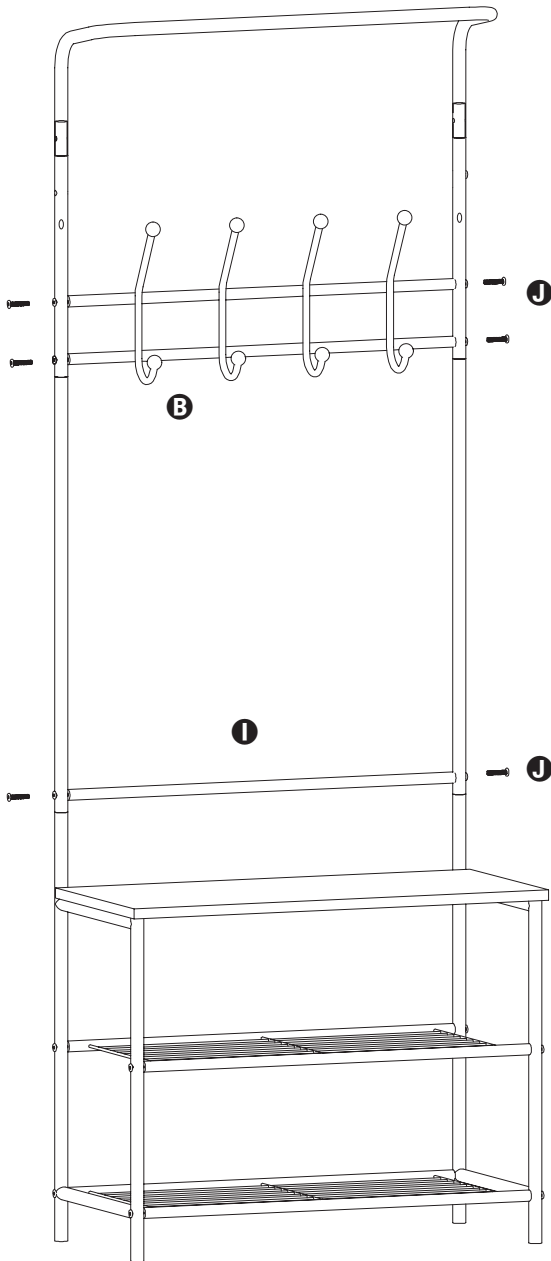

# ASSEMBLY

5

E

J

N

M

M

N

K

K

K

K

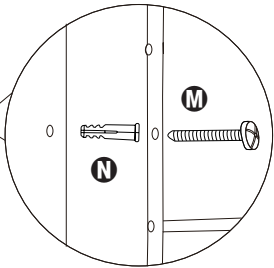
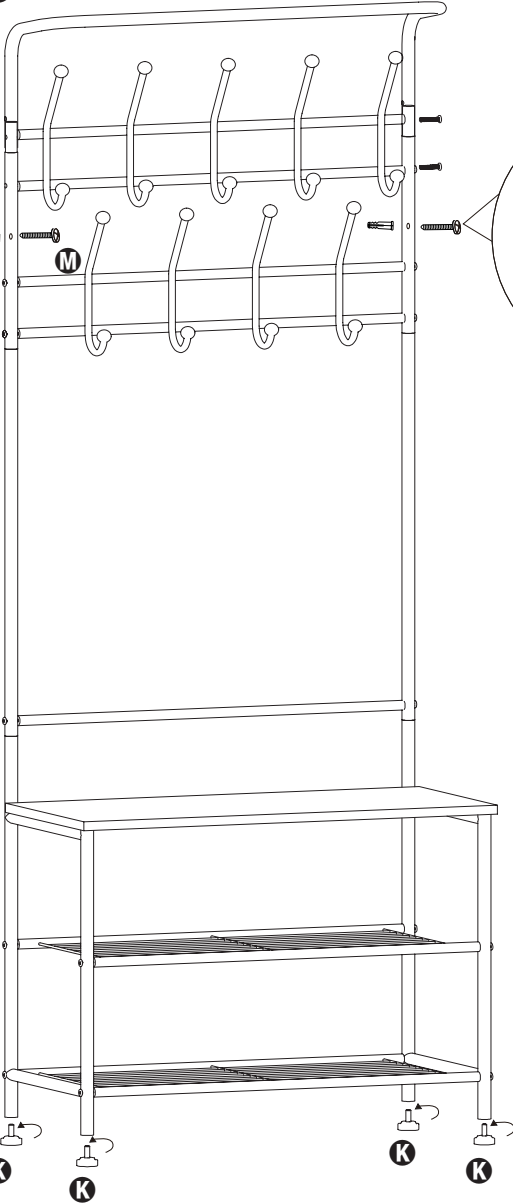



honey•can•do

**Honey-Can-Do International**

5300 St. Charles Road, Berkeley, IL 60163 USA  
877.242.2636 | [honeycando.com](http://honeycando.com) | [support@honeycando.com](mailto:support@honeycando.com)  
©2021 Honey-Can-Do International, LLC | All Rights Reserved

Visit [youtube.com/myhoneycando](https://www.youtube.com/myhoneycando) to watch our assembly videos.