



Linear Explosion Proof LED Luminaires



Date:..... Location:

Product:..... Project:.....

Quantity:..... Catalog#

FEATURES

- Linear Explosion Proof, CLASS 1, DIVISION 2 rated, Private-mold linear design maximize the best heat transmit.
- LED: LM80 certified, high efficacy, low decay, long lifespan. 130 lm/W ± 5 , up to 7800lm.
- Lens -Tempered glass shock & vibration resistant, Super clear,>90 % light transmit.
- IP66 RATED. Housing -Aluminum alloy
- Meanwell LED Driver, >90% driver efficacy
- 6KV Surge Protection.

SUITABLE APPLICATIONS

Applied in Class I, Division 2, Groups A, B, C and D;
Class II, Division 2, Groups F and G;
Class III hazardous environment

- Waste water treatment, oil and gas refineries, drilling rigs, offshore platforms, petrochemical facilities, chemical plants, coal mines, aviation bases, food plant, Pharmaceutical plant, beverage facilities, and where flammable vapors, gases, ignitable dusts, fibers or flyings are present.

CONSTRUCTION:

Copper-free aluminum alloy with body powder sprayed together Lens -tempered glass

ELECTRICAL:

Available as 120-277V input. -20°C to 50°C.

OPTICAL SYSTEM:

Lumileds LED chips. High quality transmission optics.90*120° beam angle.

INSTALLATION&MOUNTING:

Ceiling mounting/Drop mount/Wall Mount/Pole Mounting

WARRANTY:

5-year limited warranty. Actual performance may differ as a result of end-user environment and application.

PERFORMANCE

Model NO	Power Factor	Wattage	Voltage/Current Input		Light Efficiency	Kelvin Options
			120V	277V		
CES-EX-LN02-60	0.9	60W	0.5A	0.21A	130LM/W	5000K

► Electric Characteristic

Specification/Model	CES-EX-LN02-60
LED DRIVER	UL listed MEANWELL Brand
Input power	60W
Lumens output	7800LM
Efficiency	130LM/W
CRI	>72
Color Temperature	5000K
Input voltage	120-277V/AC
Light distribution type	90°*120D
Working temperature	-40°C+50°C
Junction temperature	<75°C
lamps efficiency	≥90%
Certificate	UL CUL DLC
Equivalent	400-600WMH/HPS

PRODUCT ORDERING GUIDE

CES-EX-LN02-60
1 2 3 4

CES - EX - LN02 - 60

CES LEDSION code

EX Explosion Proof LED Luminaires

LN02 Linear V2

60 Power 60W

► DIMENSION

L: 48.6in
W: 6.1in
H: 5.8in

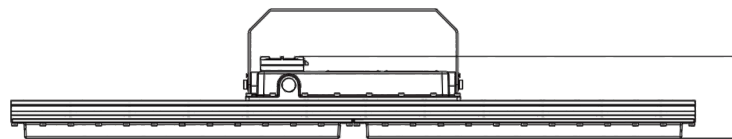
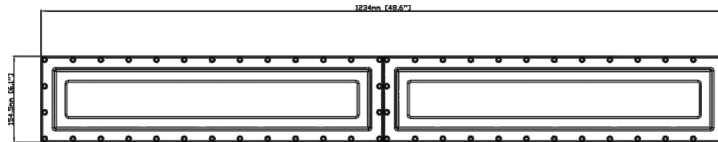

DISTRIBUTION DIAGRAM

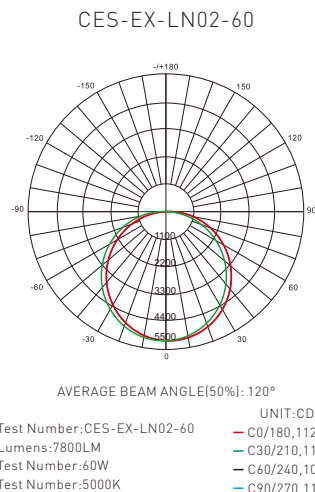

BEFORE YOU BEGIN

Read these instructions completely and carefully.



RISK OF ELECTRIC SHOCK

- Turn power off before inspection, installation or removal.
- Properly ground electrical enclosure.
- Make sure the supply voltage is the same as the rated luminaire voltage.



RISK OF FIRE

- Follow all NEC and local codes.
- Use only UL or IEC approved wire for input/output connections.
- Do not operate in ambient temperature above that indicated on the luminaire nameplate.



Warning:

CUL for Hazloc:

- SUITABLE FOR WET LOCATIONS;
- THIS LUMINAIRE IS ACCEPTABLE FOR OPERATION IN AMBIENT CONDITIONS NOT EXCEEDING 50 °C;
- FOR SUPPLY CONNECTION, USE WIRES RATED FOR AT LEAST 90°C;
- NO SERVICEABLE PARTS" OR "NO USER SERVICE ABLE PARTS. DO NOT OPEN FOR CLEANING..
- CAUTION - TO REDUCE THE RISK OF IGNITION OF HAZARDOUS ATMOSPHERES, DISCONNECT THE LUMINAIRE FROM THE SUPPLY CIRCUIT BEFORE OPENING. KEEP TIGHTLY CLOSED WHEN IN OPERATION."
- THIS PRODUCT MUST BE INSTALLED IN ACCORDANCE WITH THE APPLICABLE INSTALLATION CODE BY A PERSON FAMILIAR WITH THE CONSTRUCTION AND OPERATION OF THE PRODUCT AND THE HAZARDOUS ENVIRONMENT INVOLVED,
- CAUTION -RISK OF SHOCK" and "DISCONNECT POWER BEFORE SERVICING"

■ U-Bracket:

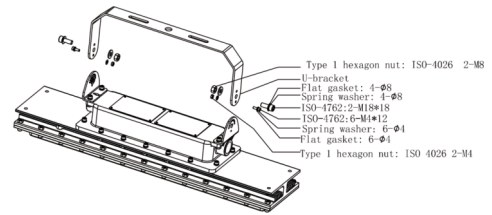
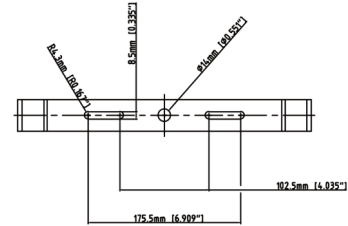

Triangle bracket size:

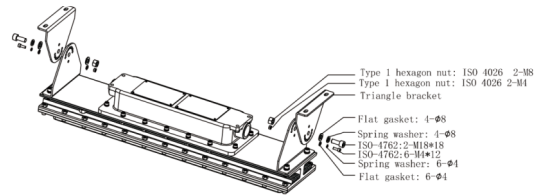
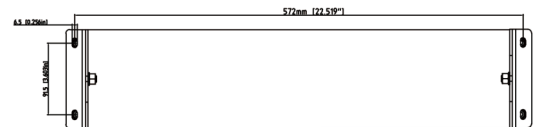

■ Ceiling mount:

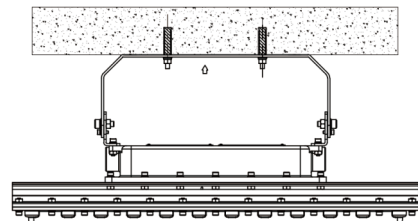
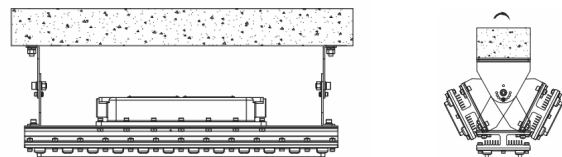

Linear Explosion Proof LED Luminaires

■ Wall mount:

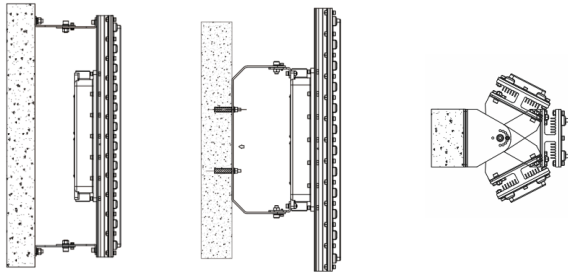

Installation steps:

Use four M6x65 expansion screws to fix on the ceiling or wall, and install it with a triangular bracket, See Steps.

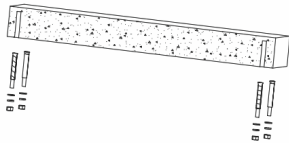

Step1: Open four holes in the wall, the hole's size is diameter of 10mm and depth of 50mm.

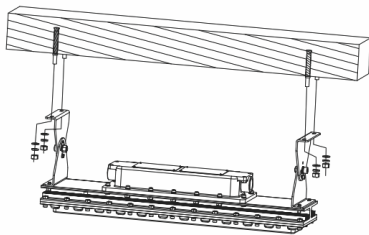

Step2: Align the mounting holes of the CES-EX-LN-02 triangular bracket with the holes of the expansion screw.

Use two M8x60 expansion screws to fix on the ceiling or wall, and install it with a U- bracket, See Steps.

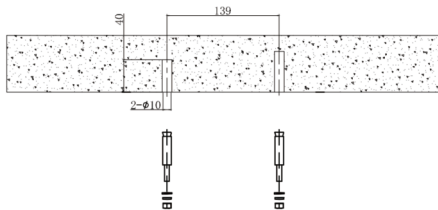

Step1: Open two holes in the wall according to the size in the picture.

-3-

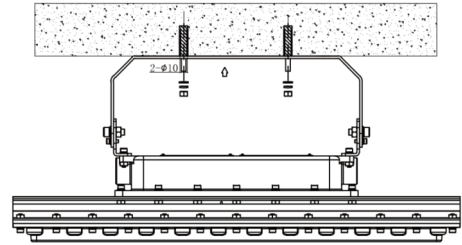

Step2: Align the mounting holes of the CES-EX-LN-02 U-bracket with the holes of the expansion screw.

■ Drop mount:

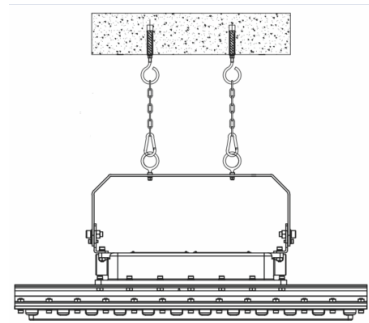

Installation steps:

Use two M6x90 expansion screws with hooks to fix on the ceiling, and connect the U bracket through the iron chain, See Steps

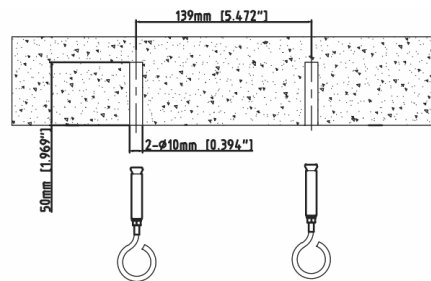

Step1: Open two holes in the wall according to the size in the picture.

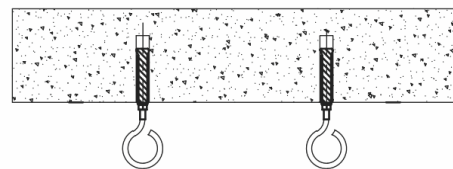

Step2: Install the expansion screws with hooks in the holes

-4-

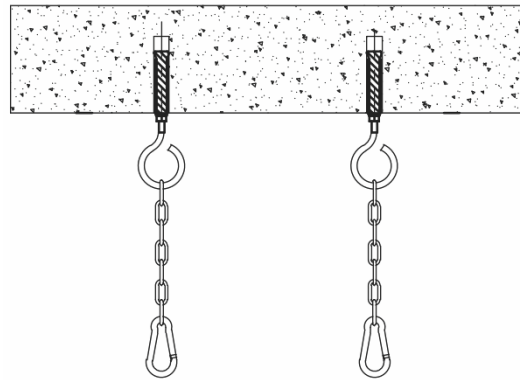

Step3: Install $\phi 4$ size stainless steel circular chain on the hooks

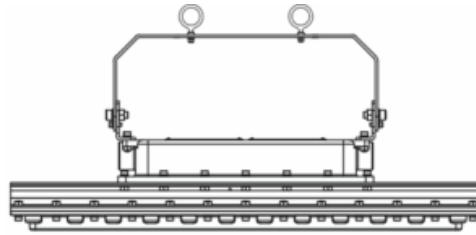

Step4: Use M6 size lifting eye to install on U-bracket.

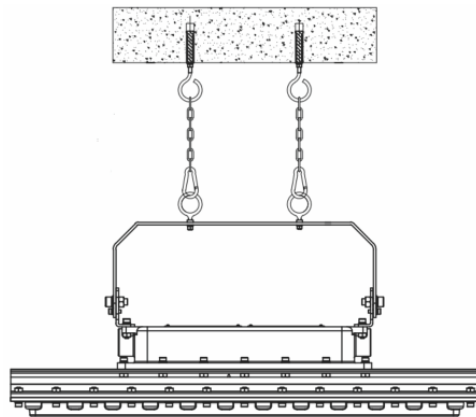

Step5: Hang the lamp on the stainless steel chain.