



LED Mini Wall Pack

Date:..... Location:

Product:..... Project:.....

Quantity:..... Catalog#



FEATURES

- Rectangle Slim design with less obtrusive appearance on the building while still fully
- Built-in universal Photocell.
- Die-casting Aluminum housing, Plastic lense.
- 0-10V dimming.
- 50000hrs life time.

SUITABLE APPLICATIONS

- Warehouses
- Stadiums
- Factories
- Parking Lots
- Shopping Malls
- Supermarkets
- Logistic Centers
- Auto dealerships



CONSTRUCTION:

Heavy die-cast aluminum alloy housing with bronze powder-coated finish.

ELECTRICAL:

Available as 120-277V input. -20°C to 45°C,

OPTICAL SYSTEM:

High brightness lumileds 2835 chips. high transmittance rate plastic optics.120° beam angle.

INSTALLATION&MOUNTING:

Wall mounting with backside plate for easy install.

WARRANTY:

5-year limited warranty. Actual performance may differ as a result of end-user environment and application.

CONTROLS&DIMMING

Built-in Photocell options,0-10v dimmable

PERFORMANCE

Model NO	PFC	Wattage Tunable	Voltage/Current Input		Light Efficiency	Kelvin Tunable
			120V	277V		
ML-WPA-26W-50K-P	>0.9	26W	0.21A	0.09A	138LM/W	3000K/4000K/5000K

Electric Characteristic

Specification/Model	ML-WPA-26W-50K-P
LED Driver	KH UL Driver
Input power	26W
Lumens output	3588lm
Efficiency	138M/W
CRI	>80
Color Temperature	5000K
Input voltage	120-277V/AC
Light distribution type	120D
Working temperature	-20+45°C
Junction temperature	<75°C
lamps efficiency	≥90%
Certificate	UL CUL DLC
Equivalent	50-90W MH/HPS

PRODUCT ORDERING GUIDE

ML-WPA-26W-50K-P

$\frac{1}{\text{ML}}$ - $\frac{2}{\text{WPA}}$ - $\frac{3}{26\text{W}}$ - $\frac{4}{50\text{K}}$ - $\frac{5}{\text{P}}$

- ML MINI LIGHT
- WPA WALL PACK
- 26W Power Output
- 50K CCT:5000K
- P Photocell

DIMENSION

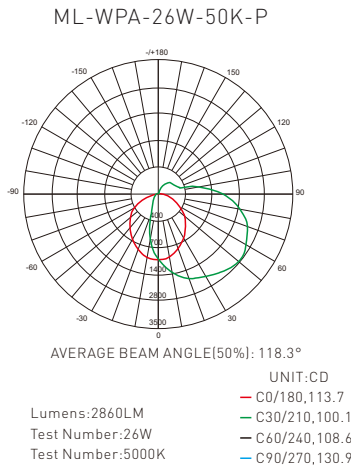

DIMENSION

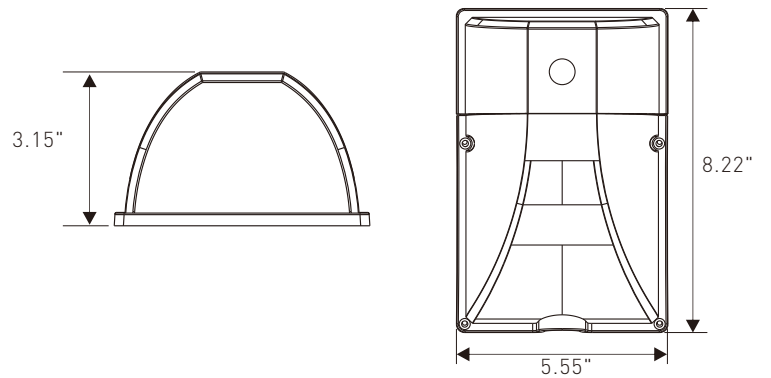

LED Mini Wallpack Installation Instruction

Cautions:

1. Can not use the electric generator to test the LED lamp.
2. Please abide by related country, regional and local law and regulations when install this fixture.
3. Please turn off the power before installation or maintenance.
4. Proper earth grounding is required to ensure safety.

Notice:

1. To avoid possibility of electrical shock or fire, the installation personnel must have professional electric knowledge.
2. Please wear gloves to avoid injury before installation.
3. If any smoke or spark of the wire happened, please turn off the power immediately and notify relevant personnel.

Attention:

1. Please check if there is any damage during shipping. If so, please contact manufacturer timely.
2. Please read the installation instruction carefully to check whether all the accessories are complete. After confirmation, then install the fixture according to installation steps.

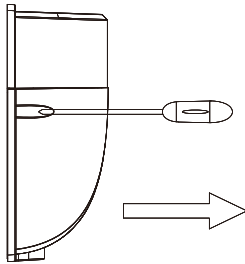

1. Remove the cover screw

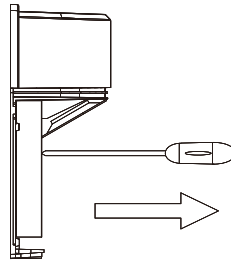

2. Then remove the wire cover screw

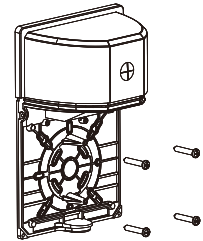

3. Punches according to wall position
And in the screw position waterproof glue

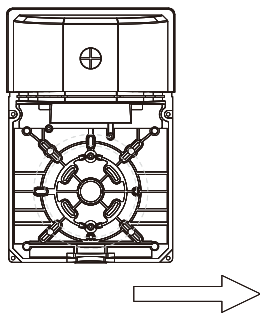

4. Fix the shell to the wall

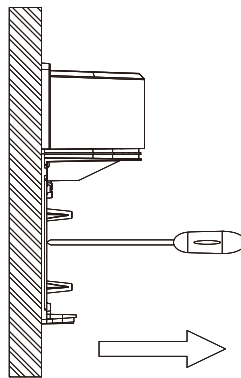

5. Cover screw twisted

