



V2 Under Canopy LED Light



Date:..... Location:

Product:..... Project:.....

Quantity:..... Catalog#

FEATURES

- IP65 rated with traditional square outlook
- Available ceiling mount and 3/4"thread conduit mount.
- Corrosion and rust proof
- 50,000 hours lifetime

SUITABLE APPLICATIONS

- Indoor Parking lot Lighting

CONSTRUCTION:

Heavy die-cast aluminum alloy housing with white powder-coated finish.

ELECTRICAL:

Available as 120-277V input. -20°C to 45°C.

OPTICAL SYSTEM:

HighLumen lumileds LED chips. 160° beam angle with clear PC cover.

INSTALLATION&MOUNTING:

Ceiling Mounting or 3/4" thread conduit Mounting for easy installation.

WARRANTY:

5-year limited warranty. Actual performance may differ as a result of end-user environment and application.

PERFORMANCE

Model NO	Power Factor	Wattage	Voltage/CurrentInput		Light Efficiency	Kelvin Options
			120V	277V		
LS-NCP55WV2-aaK	0.9	55W	0.83A	0.36A	130LM/W	5000K

V2 Under Canopy LED Light

Electric Characteristic

Specification/Model	LS-NCP55WV2-aaK
LED Driver	UL listed
Input power	55W
Lumens output	7150LM
Efficiency	130LM/W
CRI	>72
Color Temperature	5000K
Input voltage	120-277V/AC
Light distribution type	160D
Working temperature	-20+45°C
Junction temperature	<75°C
lamps efficiency	≥90%
Certificate	UL CUL DLC
Equivalent	100-150W MH/HPS

PRODUCT ORDERING GUIDE

LS-NCP55WV2-aaK

1 2 3 4 5
 [LS] - [NCP] [55W] - [V2] - [aaK]

LS LEDSION

NCP New canopy

55W Power 55W

aaK:CCT

50K CCT:5000K

DIMENSION

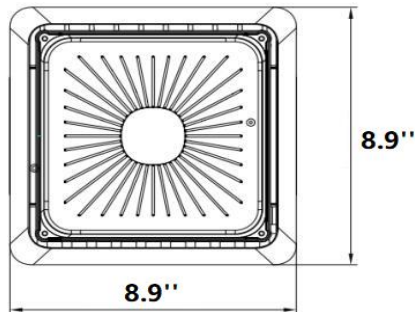
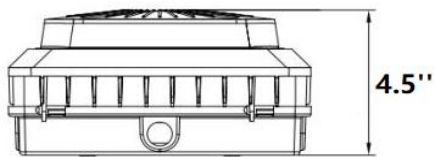

DISTRIBUTION DIAGRAM

LS-NCP55WV2-aaK

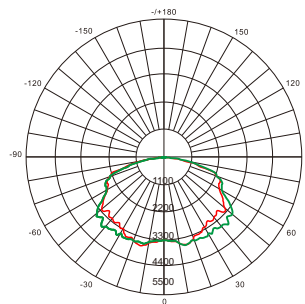

AVERAGE BEAM ANGLE[50%]: 160°

Test Number:LS-NCP55WV2-aaK
 Lumens:7150LM
 Test Number:55W
 Test Number:5000K

UNIT:CD
 - C0/180,118.9
 - C30/210,111.5
 - C60/240,109.7
 - C90/270,117.1

V2 Under Canopy LED Light

Installation Method I :

1. Disassemble the driver box cover by loosening the two screws on the driver box; Figure 1-1
2. Loosen the 3/4 plug on the driver box cover by screwdriver; Figure 1-2
3. Fix the driver box cover on the 3/4 tube; Figure 1-3
5. Connect the input line and ground; If the fixture is equipped with sensor, adjust the sensor settings, Take relevant waterproof measures after the wires are connected; Figure 1-5
6. Turn the radiator up then cover the driver box, Figure 1-6
7. Lock the two cap screws, the product is installed. Figure 1-7

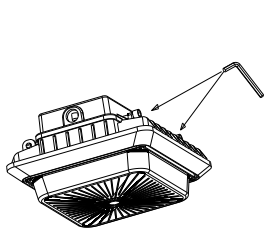

Figure 1-1

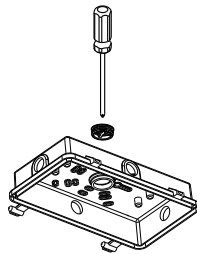

Figure 1-2

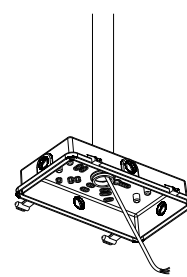

Figure 1-3

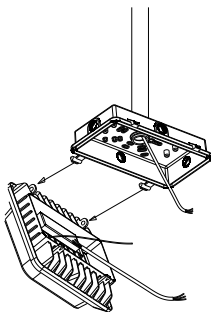

Figure 1-4

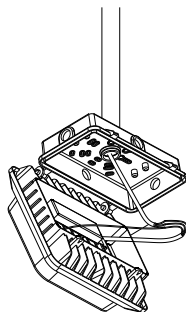

Figure 1-5

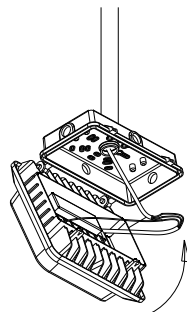

Figure 1-6

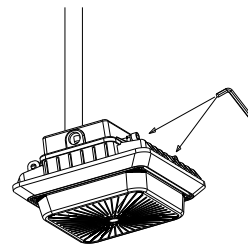

Figure 1-7

Installation Method II :

1. Disassemble the driver box cover by loosening the two screws on the driver box; Figure 2-1
2. Loosen the 3/4 plug on the driver box cover by screwdriver; Figure 2-2
3. Drill the holes on the ceiling accordingly to fit the plate; Figure 2-3
4. Fix the driver box cover on the ceiling; Figure 2-4
5. Insert the mounting hole of radiator horizontally on the shaft of driver cover; Figure 2-5
6. Connect the input line and ground; If the fixture is equipped with sensor, adjust the sensor settings; Take relevant waterproof measures after the wires are connected; Figure 2-6
7. Turn the radiator up then cover the driver box, Figure 2-7
8. Lock the two cap screws, the product is installed. Figure 2-8

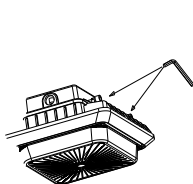

Figure 2-1

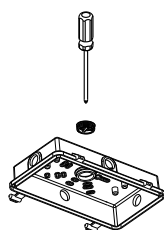

Figure 2-2

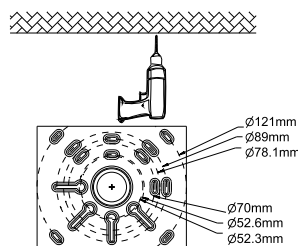

Figure 2-3

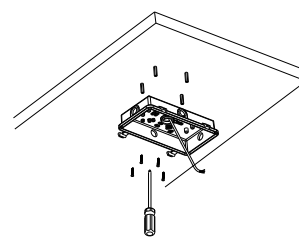

Figure 2-4

V2 Under Canopy LED Light

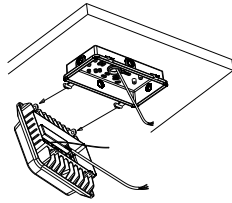

Figure 2-5

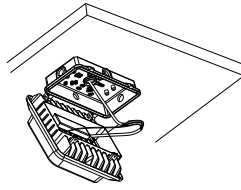

Figure 2-6

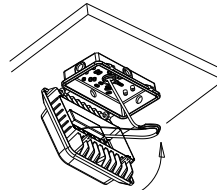

Figure 2-7

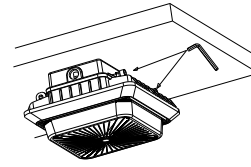

Figure 2-8