

PPS-12X4-760-DH



Please check your box for accuracy.  
All of these pieces should be included.

ITEM	PART NUMBER	QTY.
A	TLCM-C-2	4
B	TLCM-E-2	4
C	TLCM-P-2	4
D	TLCM-P-4	1
E	TLCM-PINS50	1 Bag
F	651-BLACK	4
G	760-2X4-PPS	2
H	760-4X4-PPS	1
I	PPS-PANEL-2X4	2

**RUBBER BASE**

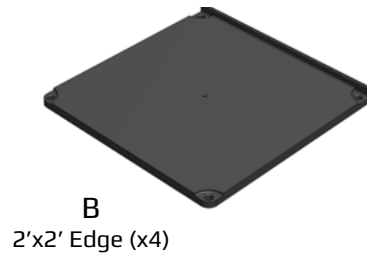
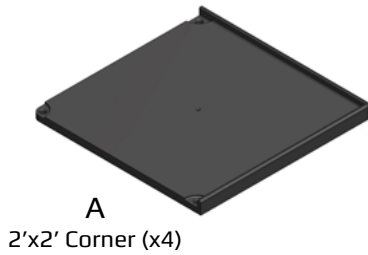

**HARDWARE**

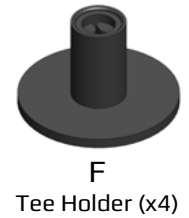
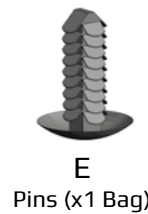
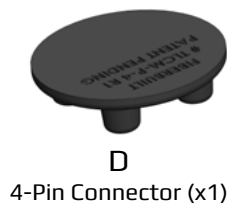
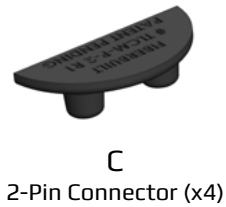

**GRASS PANELS**

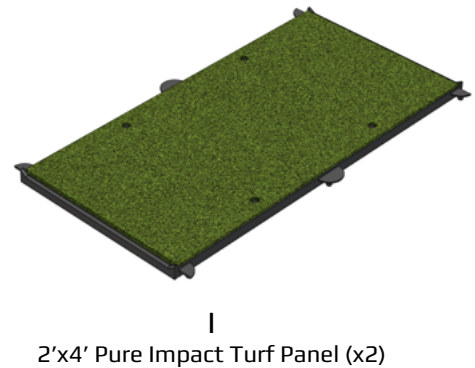
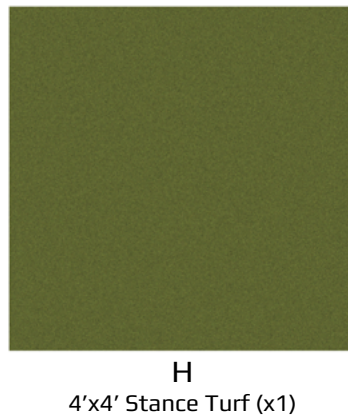

[Images not to scale]

1

Ensure the ground is properly prepared for placement of the rubber base. The surface should be firm, packed and level. Concrete, asphalt, patios or decking are ideal. (Do not place on grass.)

Place the rubber base pieces (A, B) and Pure Impact Turf panels (I) on the ground together as shown.

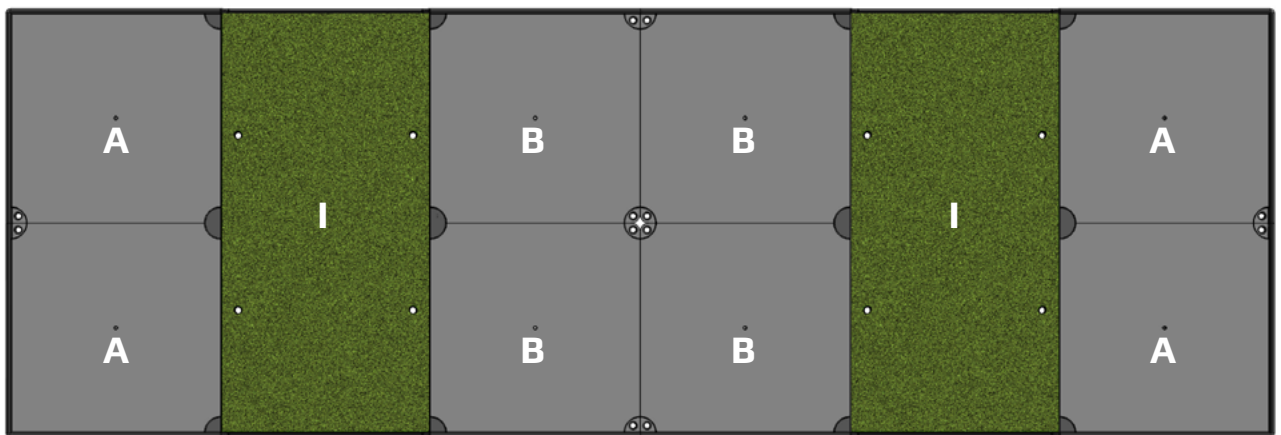

2

Insert the tee holders (F) into the underside of the desired tee locations on the Pure Impact Turf panels (I).

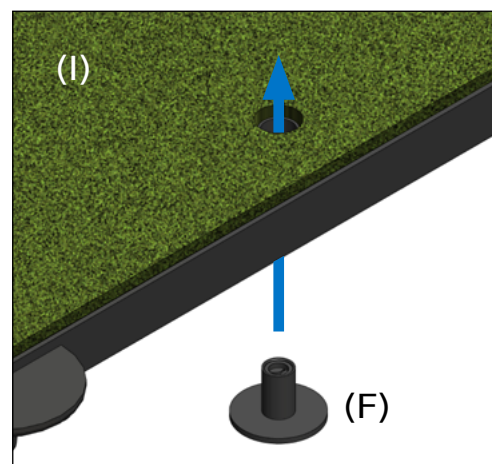

3

Secure rubber base pieces (A, B) and Pure Impact Turf (I) together by pushing Connectors into adjacent holes in the sections.



2-Pin Connectors (C) for side connections

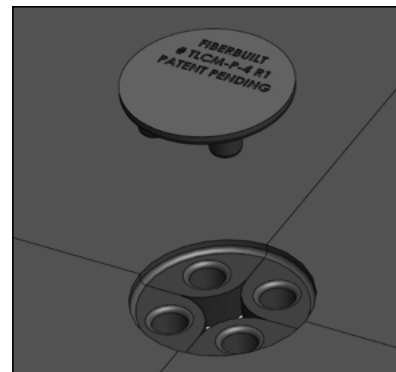

4-Pin Connectors (D) for center connections.

Optional Step: For increased security and stability, install and secure Connectors with pins from underneath as you assemble the base pieces. (If the mat will be regularly moved or disassembled, we recommend skipping the use of the pins.)

Steps for securing the pins:

- As you set base pieces next to each other, lift up the corners of the rubber base pieces and place a plastic push pin (E) into the holes from underneath.
- From the top, push the rubber 2-pin (C) or 4-pin (D) Connectors into position, guiding them onto the plastic push pins.
- Gently tap with a hammer until the connectors are flush with the base surface.

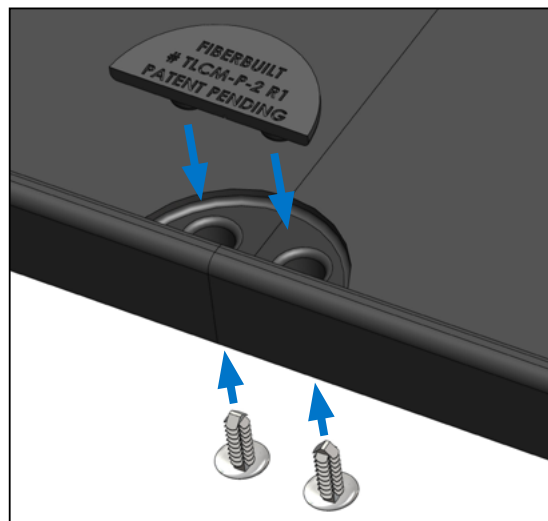

4

Lay the Spacer Turf (G) and Stance Turf (H) on top of the base areas that fit their sizes.

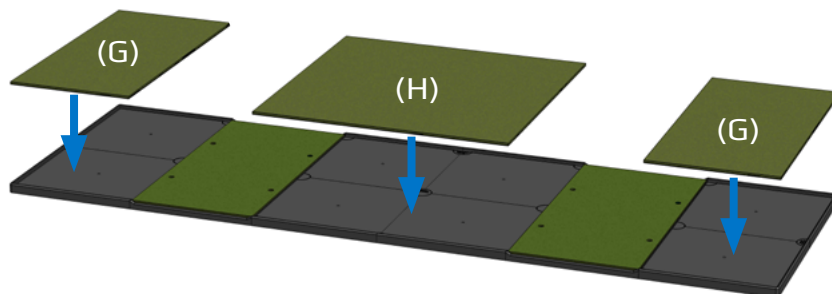

NOTE: We ship our turf folded in the box for the most expedient shipping. During transit, the turf pieces may curl slightly. If your turf is curled upon delivery, we recommend laying the turf pieces flat in the sun for a couple of hours to allow them to relax and flatten prior to laying them down on the base.



## DOUBLE THE LIFE OF YOUR WARRANTY TODAY FOR FREE

For a free one-year extension to our standard warranty, exclusive access to insider deals, new product information and much more, register your mat today at:

**[FiberbuiltGolf.com/register](https://FiberbuiltGolf.com/register)**

Be sure to select the following:

**PLAYER PREFERRED SERIES STUDIO MAT  
DOUBLE-HITTING - 12X4'**

SKU#: PPS-12X4-760-DH