

Features

- UL Listed for US and CANADA
- Listed to UL924 and tested to CSA C22.2 NO.141 Field or factory installation
- High output voltage
- Low energy consumption CEC Title20 compliance
- Constant output power
- Self-testing
- Battery:over temperature protection
- Remote Test Switch: Distance for 98ft (This accessory is optional)

Specifications

- Input Voltage:100~347Vac, 50/60Hz
- Input Current:200mA max.
- Input Power Rating:12W max.
- Recharge Time:24Hrs
- Output Voltage:170Vdc
- Emergency Power:15W/25W/40W
- Discharge Time:1.5H
- Battery:Ni-MH or Li-ion
- Warranty:5 Years
- Ambient Temp:32~122°F(0~50°C)
- Weight:4.14 lbs(1.88kg)



HIGH VOLTAGE OUTPUT
170V DC

UL US
LISTED
E504476



RoHS
COMPLIANT



IP65

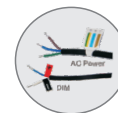

- Emergency output wire to led driver AC input



- 2-in-1, waterproof Led test switch and indicator light



- UL Listed Water-proof Flexible Conduit : 13"

CP CONSTANT
POWER
EMERGENCY OUTPUT

**CERTIFIED IN
TITLE
20** Certified in CA TITLE 20
Appliance Efficiency Database -
Battery Charger

UL US
LISTED
E504476



Emergency LED Driver

EMUFO Series

Model NO.

Model NO.	Emergency Power
EMUFO-15170-YY	15W
EMUFO-25170-YY	25W
EMUFO-40170-YY	40W

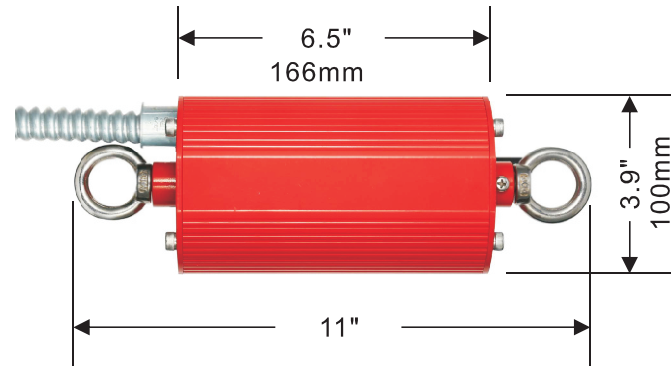

ACCESSORIES



A

- (8) pcs of wire nuts
- (2) pcs of hooks
- (1) pc of signal receiver



B

- (1) pc of safety rope
- (1) pc of chain link connector



C

- (1) pc of flex conduit 13"



D

- (1) pc of remote

SELF-TEST

- The emergency LED driver contains a control/monitor circuit which will perform a 30-second discharge test once a month and a fully discharge test once a year. At this time, the unit simulate an AC power failure and automatically switch to emergency mode. During routine testing, the unit will monitor the operation of the LED load, battery voltage, and emergency duration, if the unit detect any problems, the indicator will flash quickly.

Function

A: For 30 seconds/Off
B: For 90 minutes

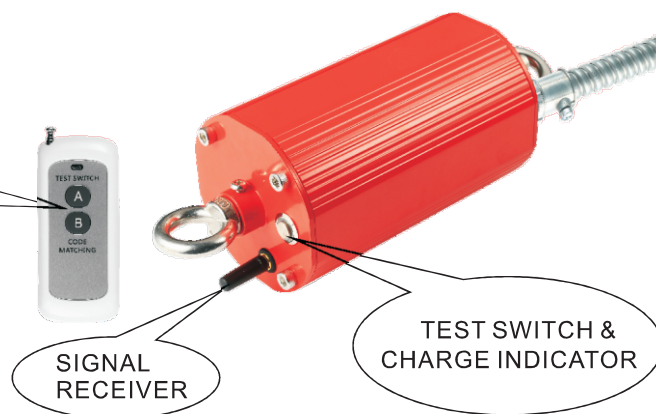

Indicator Light

- AC Operation, indicator light will keep on
- Emergency Operation, indicator light flash slowly (light on for 2 seconds, light off for 2 seconds)
- In a failure, indicator light flash quickly (light on for 0.2 seconds, light off for 0.2 seconds)

Test Switch

- In AC operation, press test switch or “A” on remote test switch, the fixtures will switch into emergency model for 30 seconds.
- In AC operation, press “B” on remote test switch, the fixtures will switch into emergency model for 90 minutes.
- In emergency operation, press “A” on remote test switch 10 seconds later, the fixtures will switch into AC model.

Wiring Diagram

CAUTION:

- During AC operation, remember no touch or remove any wires in case of electric shock.
- During emergency operation, before touching or disconnecting any of the wires, make sure press test switch or button “A” on remote test switch to turn off power.
- The voltage input to the dimmable wires(DIM+,DIM-) of emergency LED driver must less than 20Vdc.
- For emergency LED driver of EMUFO-15170-YY/EMUFO-25170-YY better work with LED lamp not more than 150W, for EMUFO-40170-YY must work with LED lamp not more than 300W.
- This emergency LED driver only work with LED lamp with dimmable function.

A) Without Dimmer and Sensor

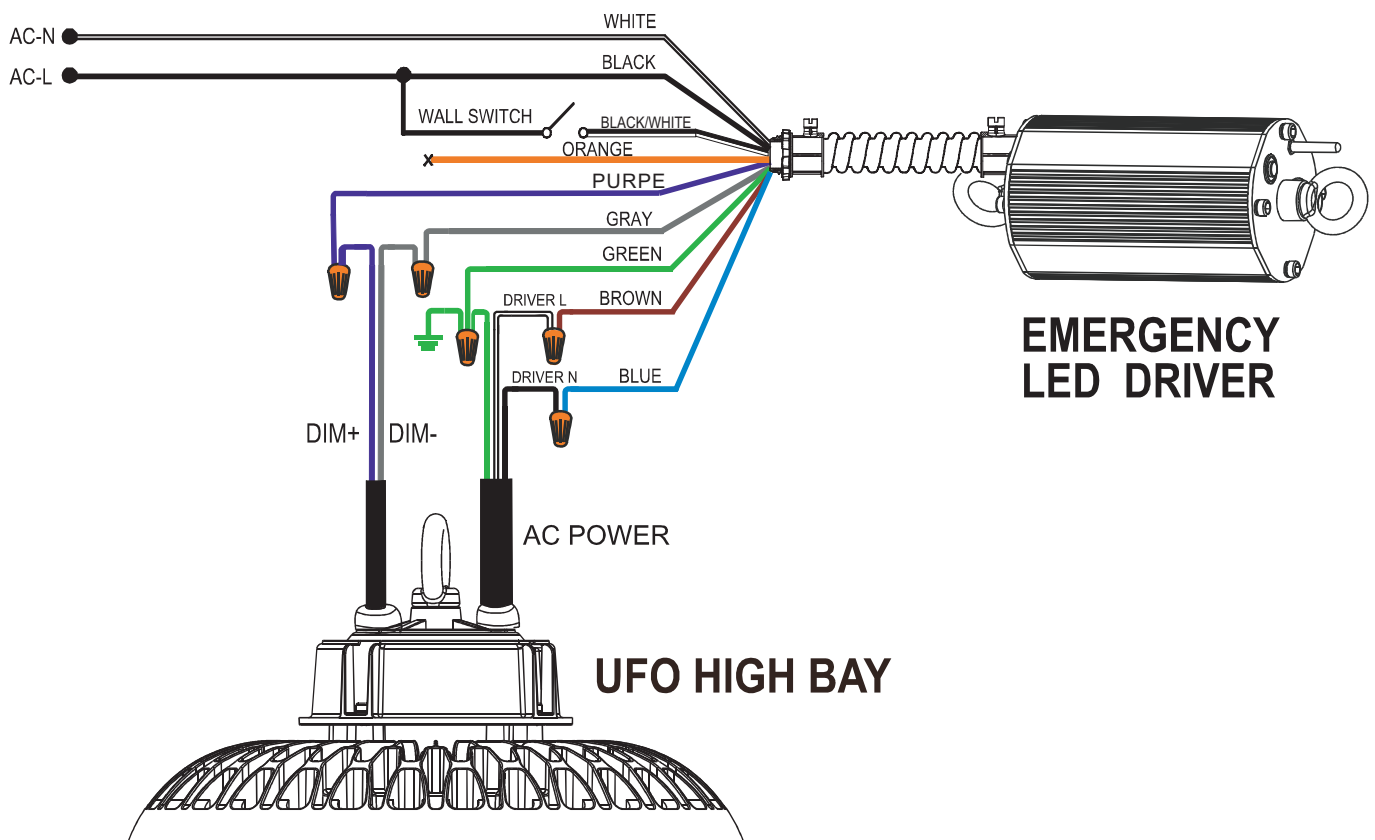

B) With Dimmer

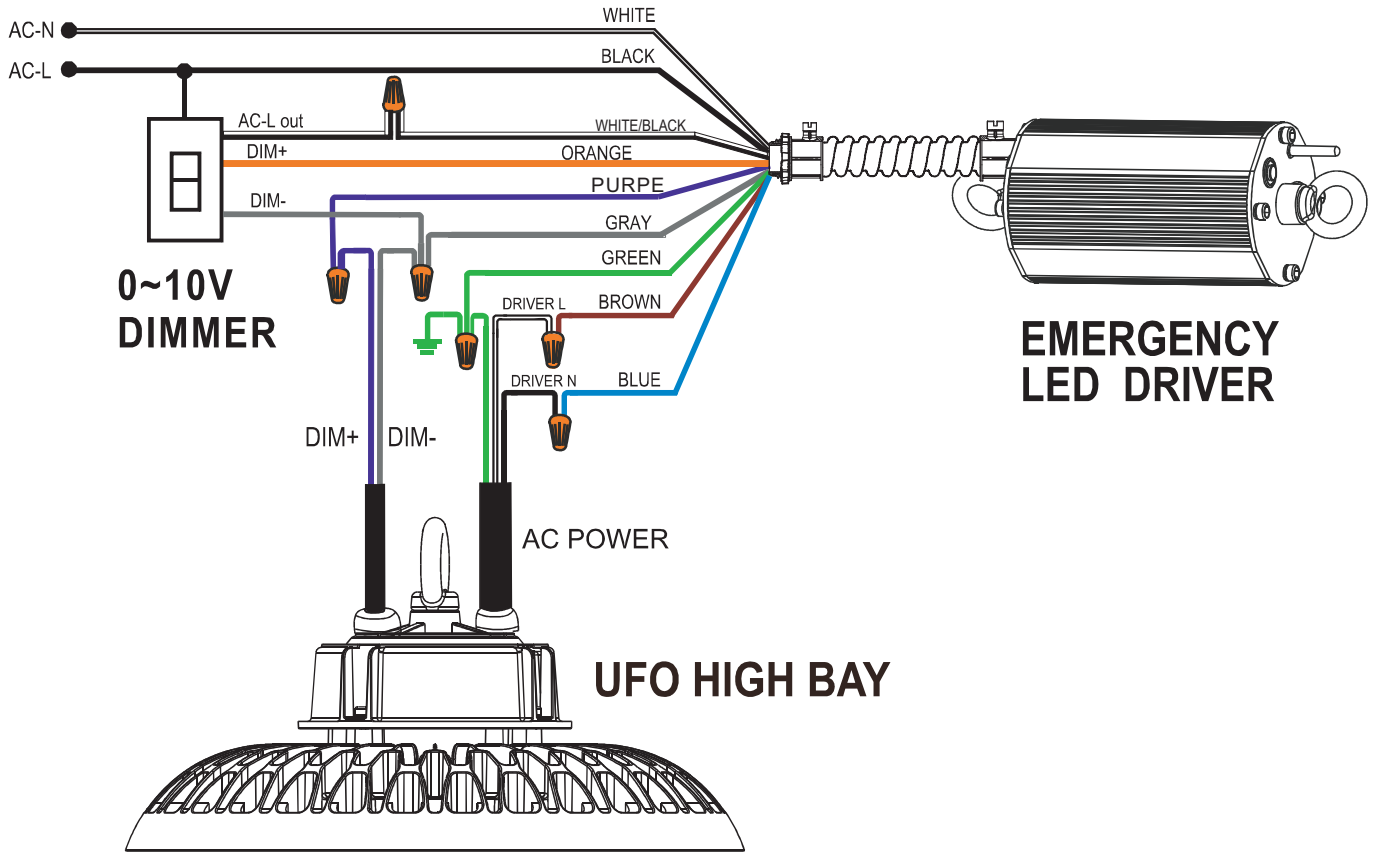

C) With Sensor

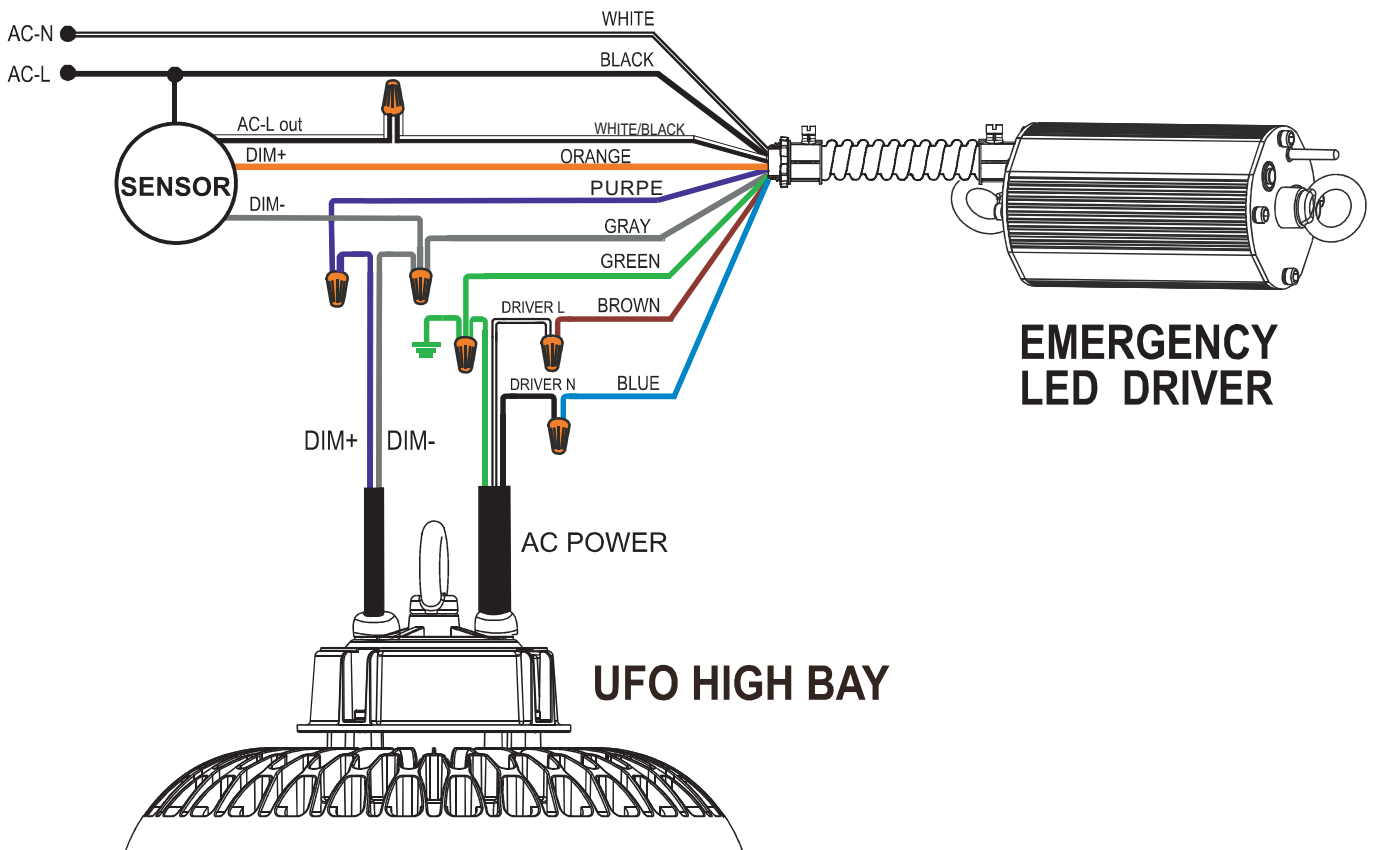

Package

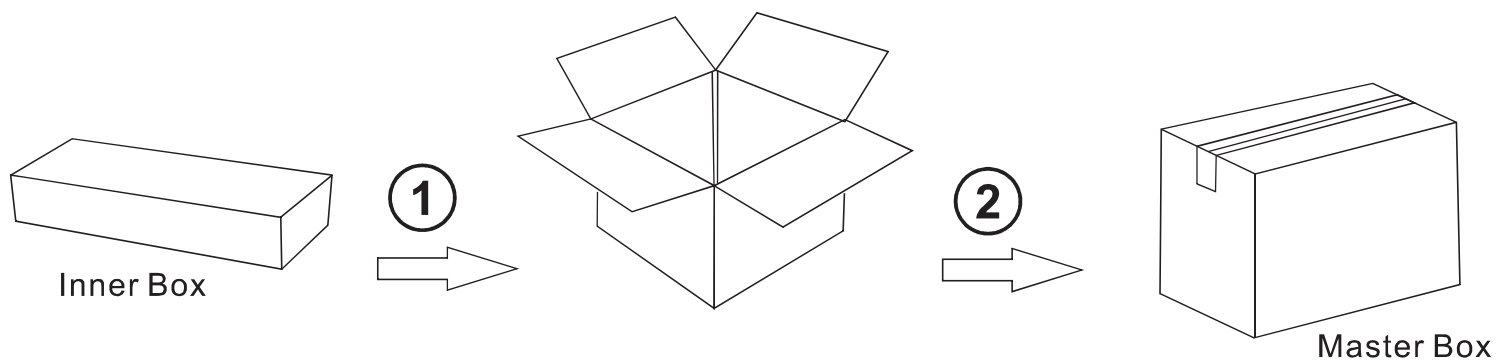

Package information are as following forms

Power	Length(inch)	Width(inch)	Height(inch)	G.W(kg)	N.W(kg)	QTY(pcs)
15W	16.06"	15.47"	10.31"	10	6	4
25W	16.06"	15.47"	10.31"	10.5	7	4
40W	16.06"	15.47"	10.31"	11	7.5	4