

FOSSIL BLU

FSW1115

30" LUXURY HEAVY-GAUGE COPPER SINK

MATERIAL:

12-GAUGE

99.7% PURE COPPER

(0.3% MINERAL PHOSPHOROUS; ADDED FOR STRENGTH)

INSTALL:

UNDERMOUNT OR DROP-IN

FINISH:

**HAND-HAMMERED
MEDIUM NATURAL PATINA**

ACCESSORIES INCLUDED:

CLASSIC SINK GRID

DISPOSAL FLANGE

(ACCESSORY FINISH: ANTIQUE COPPER)

WEIGHT:

35.2 LBS (EMPTY)

161.3 LBS (FILLED)

CORNER RADIUS:

MODERN 1/2" RADIUS

WARRANTY:

LIMITED LIFETIME

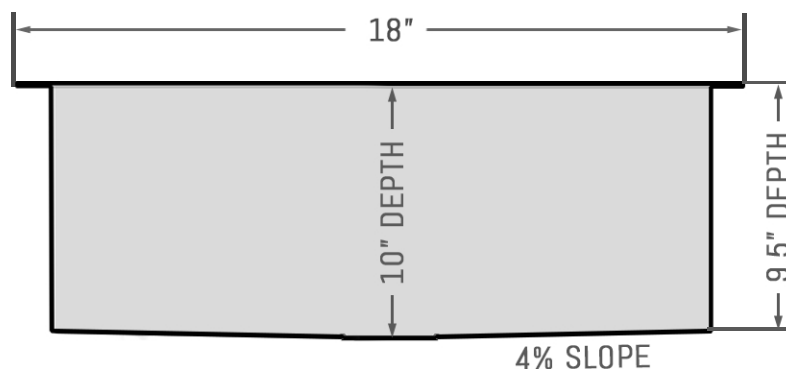
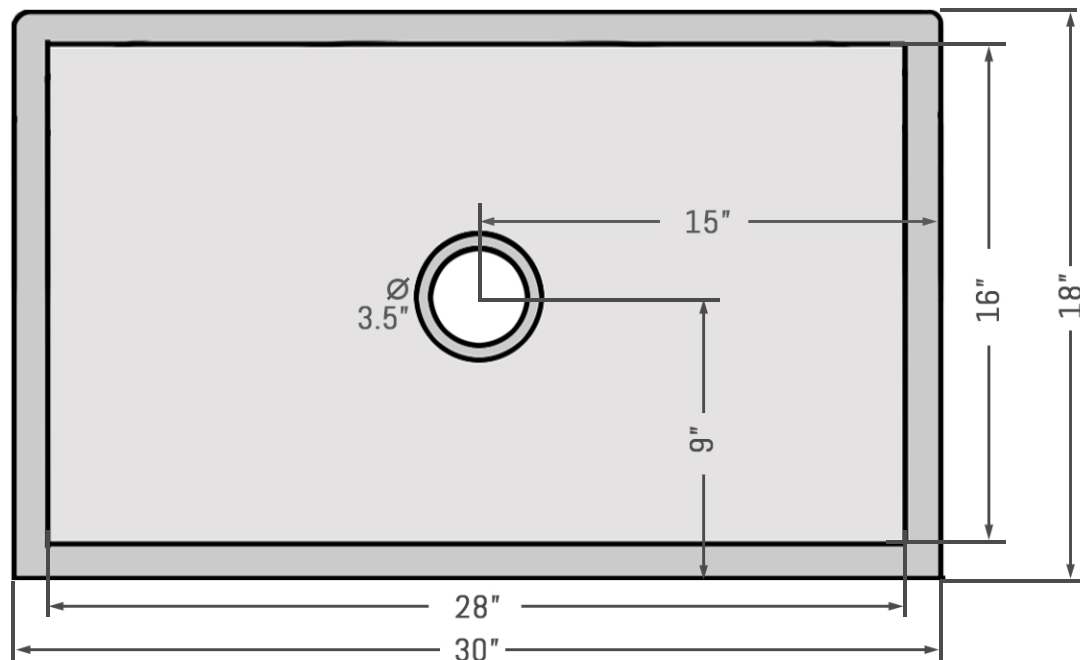

HANDMADE PRODUCT; MEASUREMENT TOLERANCES HELD TO +/- 2%