



# VESPA

3D PEN TEMPLATE



Thank you for your purchase!

Enjoy our 3D pen stencils. They are meant to serve as guide to make 3D pen creations more accurate and enjoyable. You can use them free hand, but they work best with our **3Dmate BASE Design Mat**

- **Free hand** - place the stencil on a flat surface and trace the printed lines with the 3D pen (you may cover the printout with parchment or tracing paper). Once filament cools, remove the pieces from the paper and fuse them together as instructed.
- **3Dmate BASE Design Mat** – the easy way to improve the quality of your creations. Place the stencil under the mat, draw within the indicated grooves. Once the filament cools, bend the mat and remove the piece and fuse together with other parts as instructed. Enjoy your perfect 3D creations.

NOTE: These and additional stencils are available for download at: [www.the3dmate.com/projects](http://www.the3dmate.com/projects). Please enjoy.

**3Dmate BASE** can be purchased on Amazon.

Search for keyword:

“**3Dmate BASE 3D Pen Mat**” or use the QR code:

Choose 3Dmate BASE branded mat to assure stencil compatibility.



Please leave us a review on Amazon.  
Your review helps other customers and is greatly appreciated.

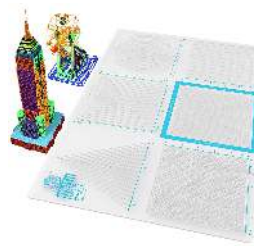

Get all the filament colors needed to complete this creation and more!

Buy Filamate 36 color PLA filament pack on Amazon at: [www.bit.ly/filamate-stencils](http://www.bit.ly/filamate-stencils)



You can find helpful YouTube video guide showing how to complete this stencil here:

[www.bit.ly/3dmate-yt-vespa](http://www.bit.ly/3dmate-yt-vespa)





## Lower Left Square

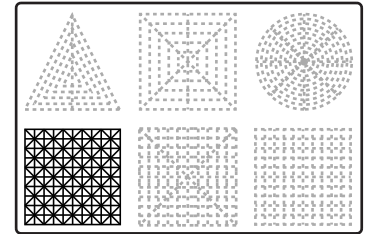

Recommended filament colors:



Blue Orange

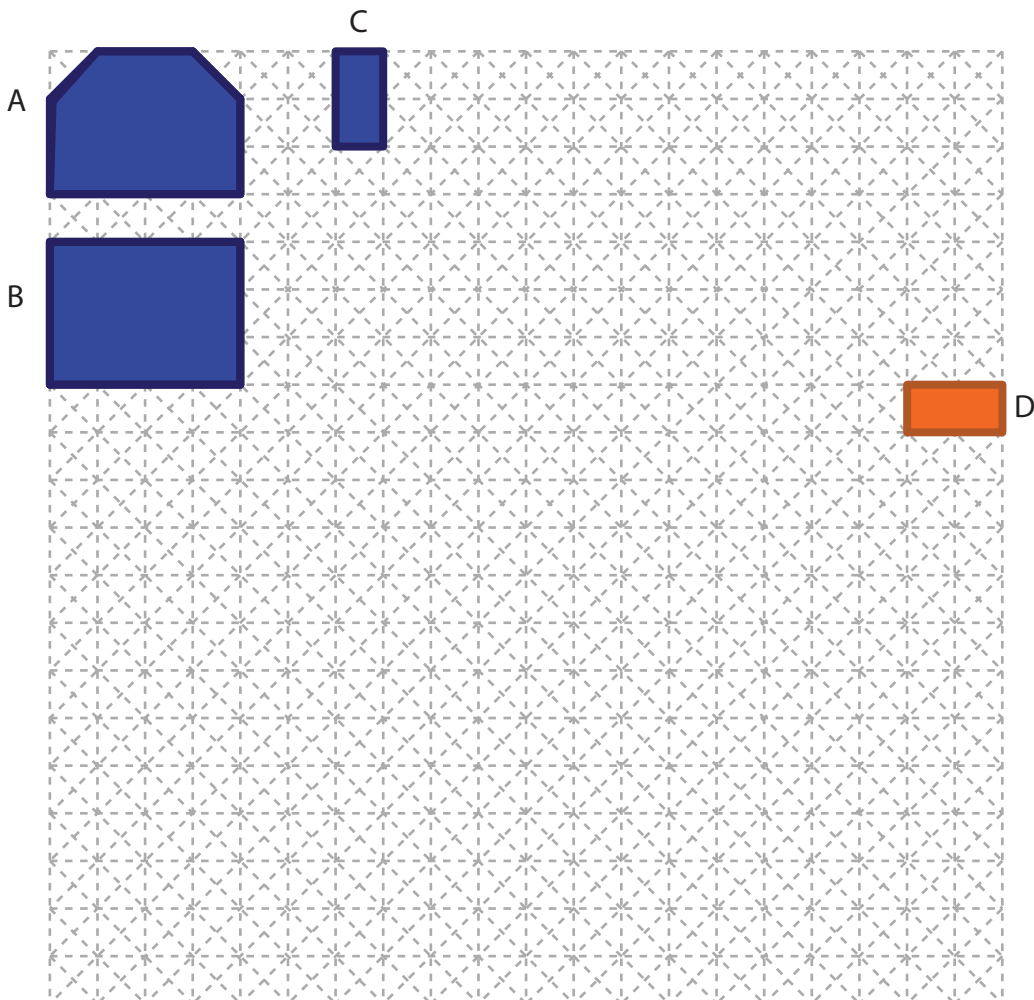



## Lower Middle Square

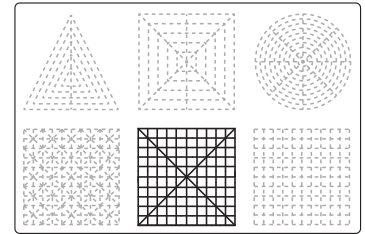
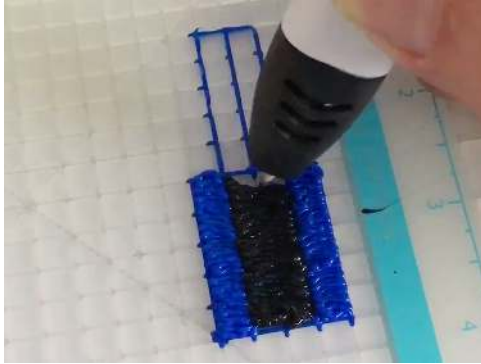

Recommended filament colors:

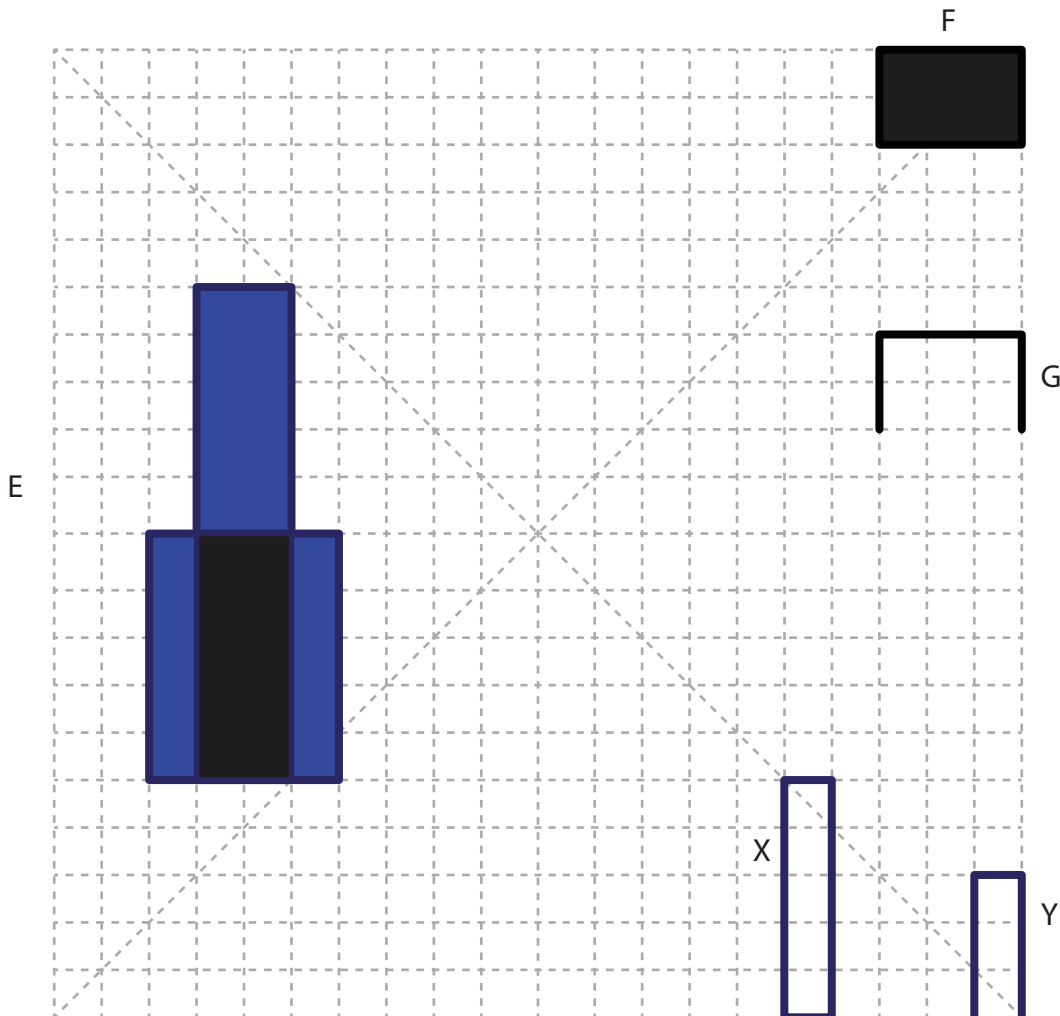



## Upper Right Circle

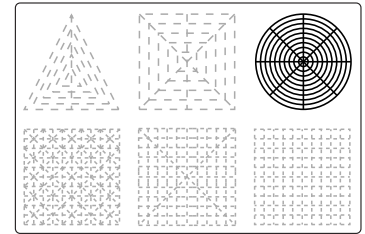

Recommended filament colors:



Blue

White

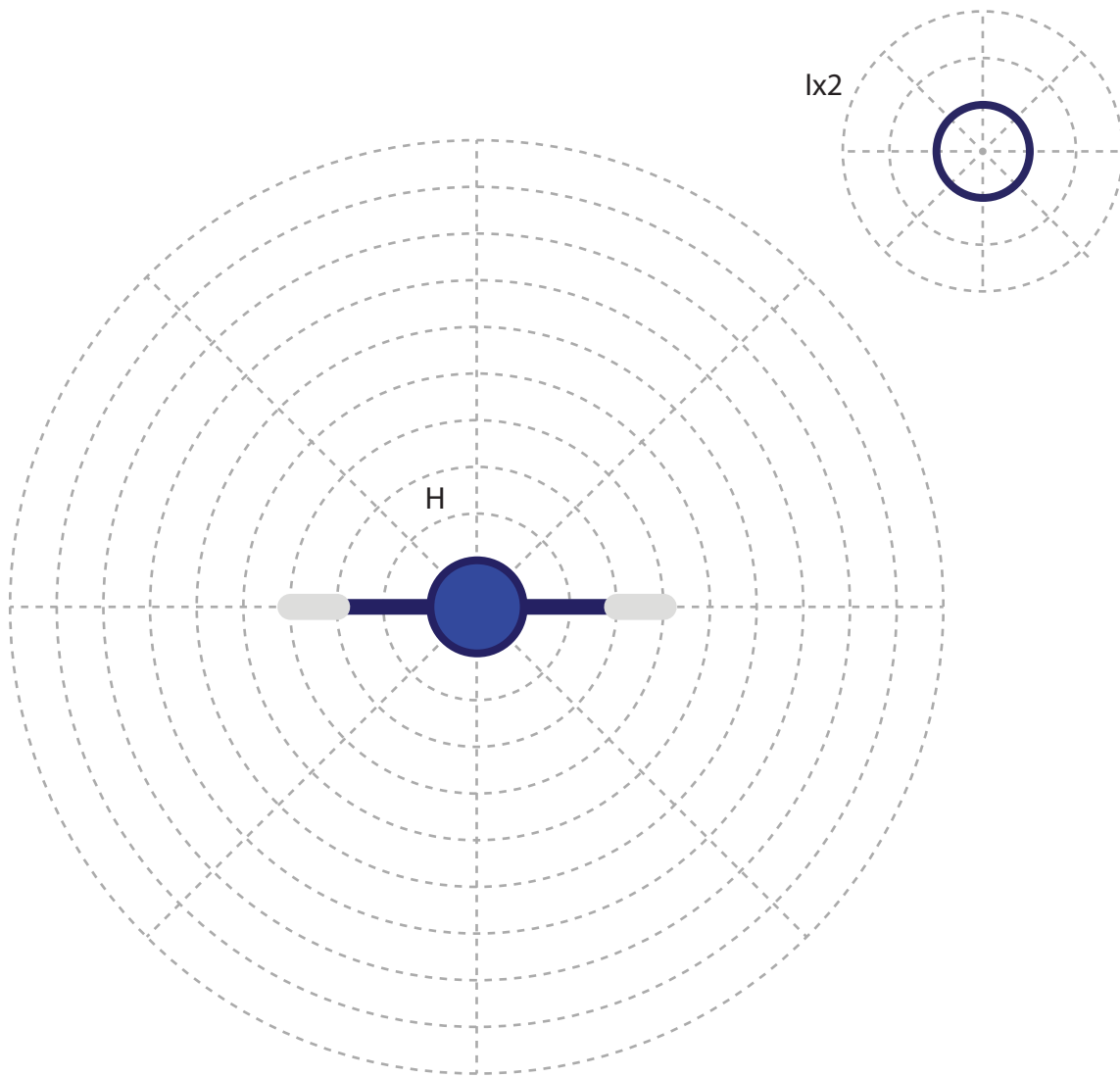



## Upper Right Circle

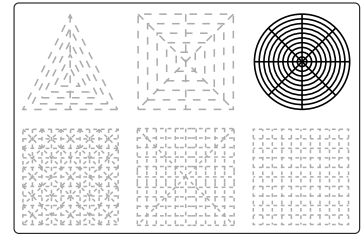

Recommended filament colors:

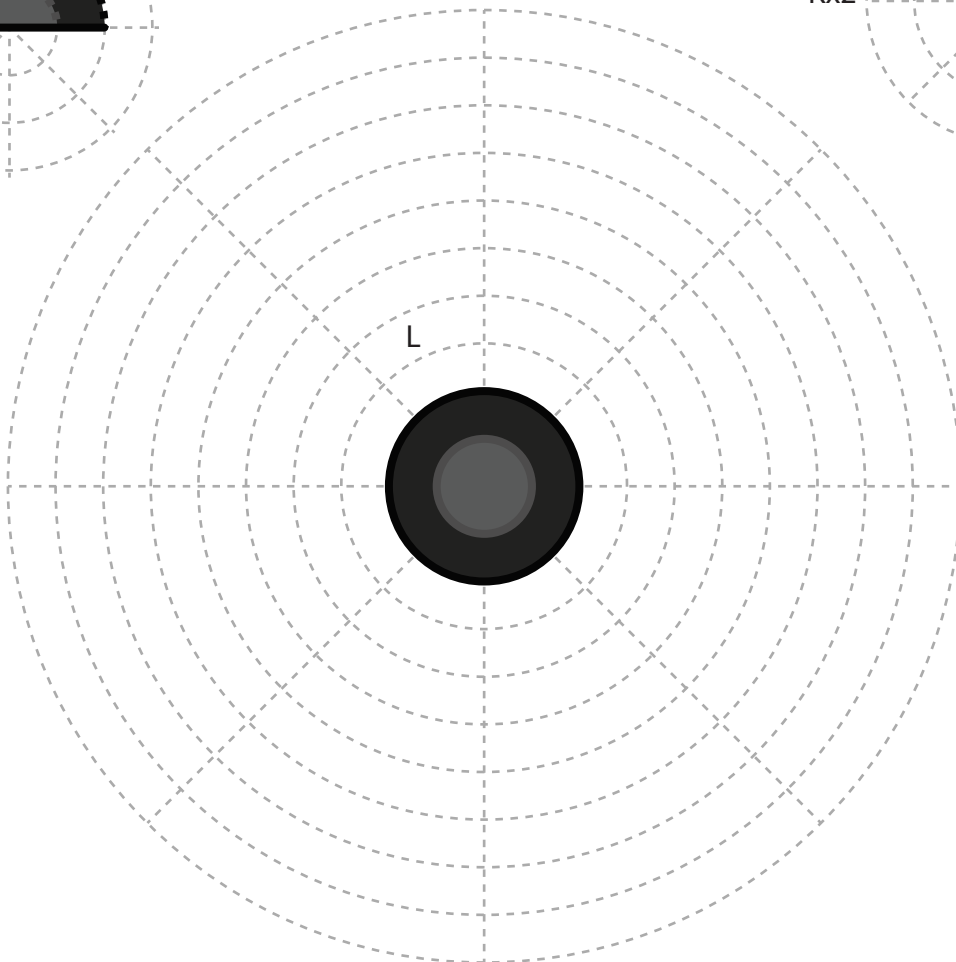
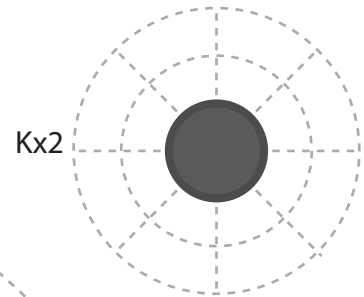
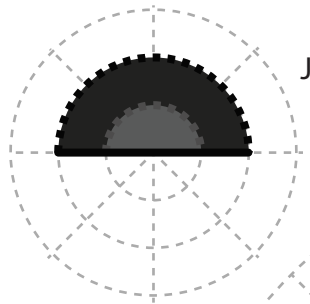

3Dmate BASE design mat is available on Amazon at:  
[www.bit.ly/3dmate-base-stencil](http://www.bit.ly/3dmate-base-stencil)



Video Tutorial Available at:  
[www.bit.ly/3dmate-yt-vespa](http://www.bit.ly/3dmate-yt-vespa)



## Upper Right Circle

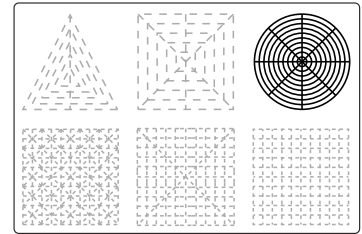

Recommended filament colors:



Blue

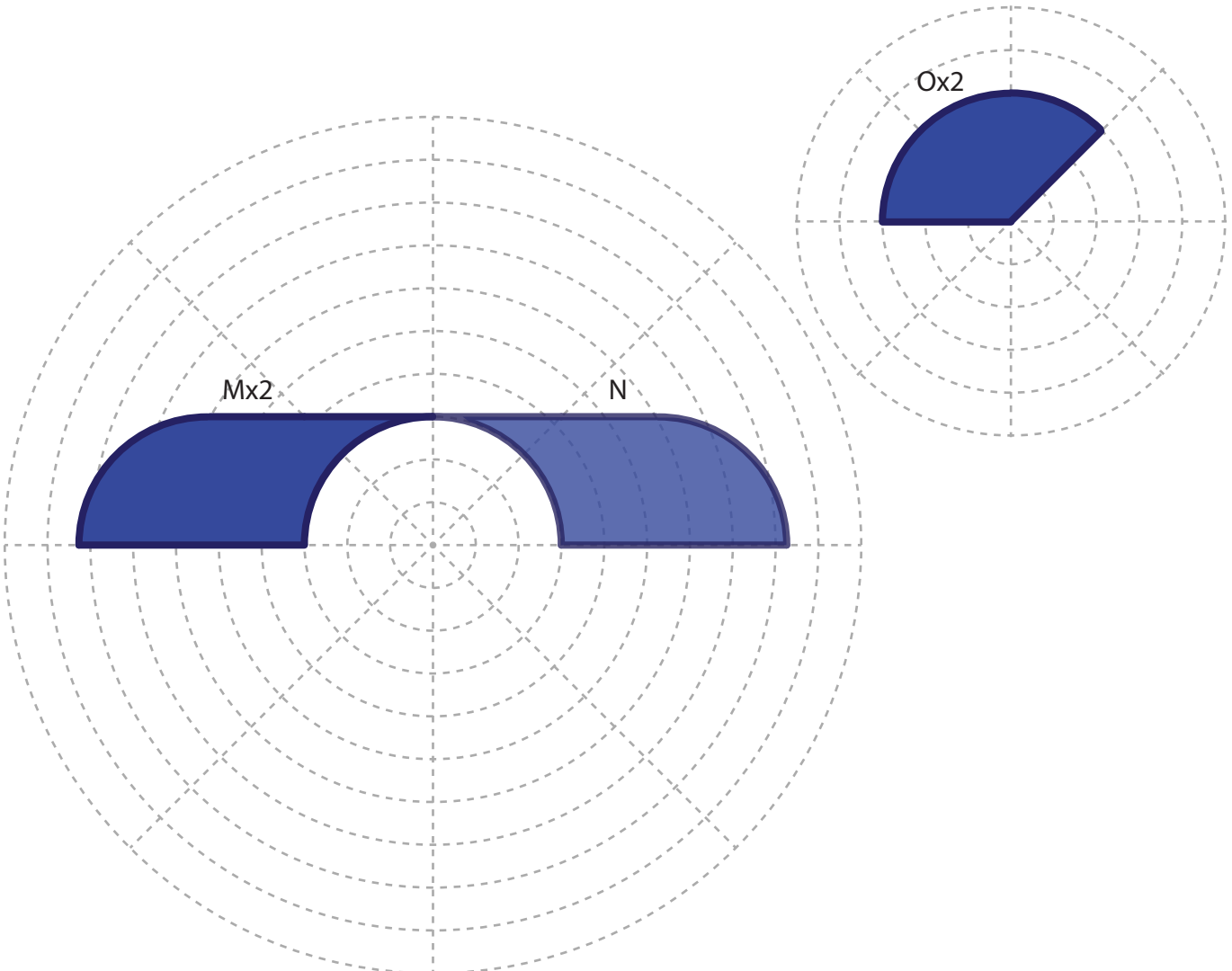



## Upper Right Circle

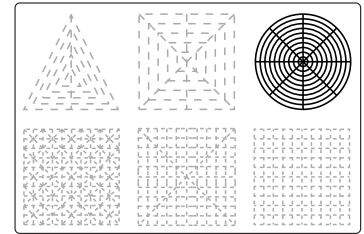

Recommended filament colors:



Blue

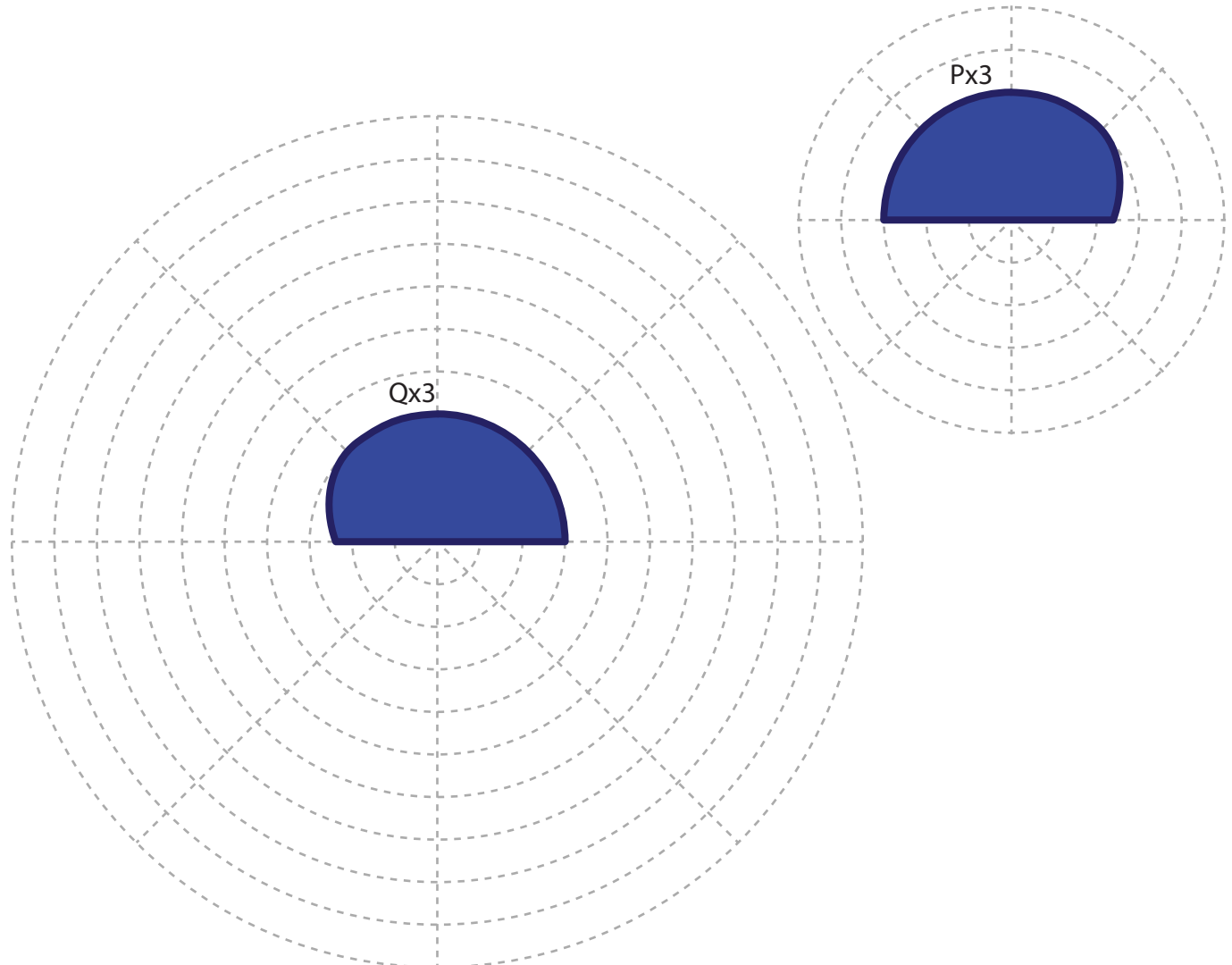



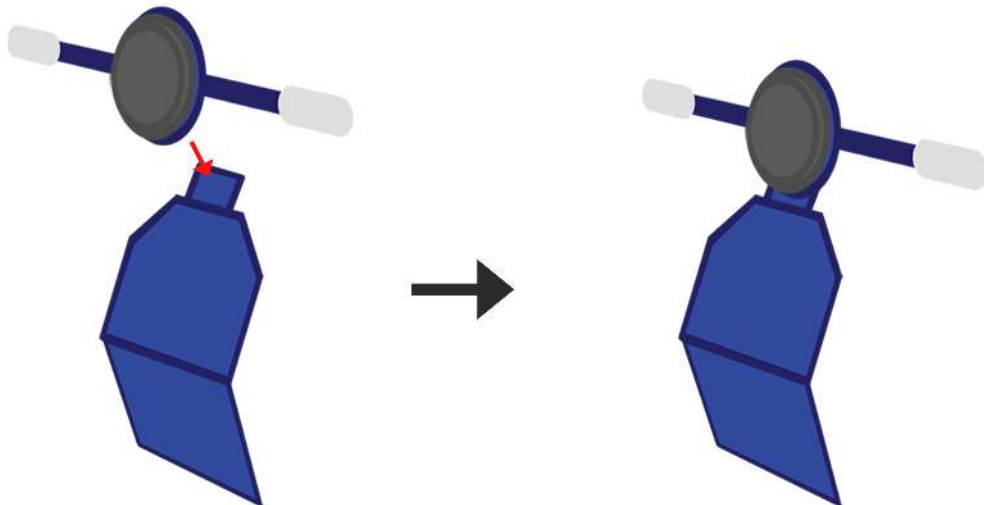
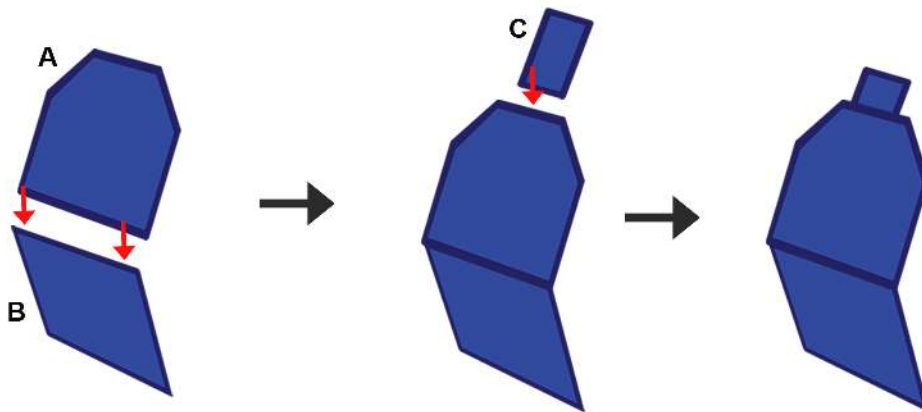
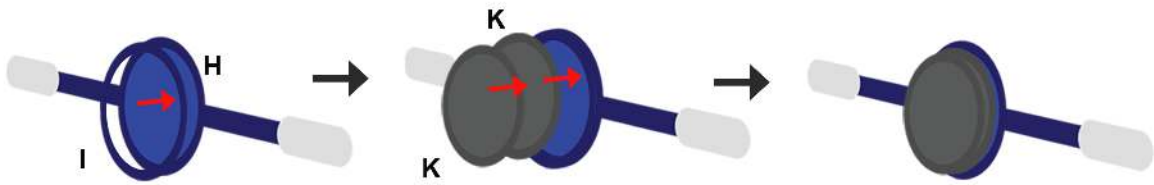

3Dmate BASE design mat is available on Amazon at:  
[www.bit.ly/3dmate-base-stencil](http://www.bit.ly/3dmate-base-stencil)



Video Tutorial Available at:  
[www.bit.ly/3dmate-yt-vespa](http://www.bit.ly/3dmate-yt-vespa)

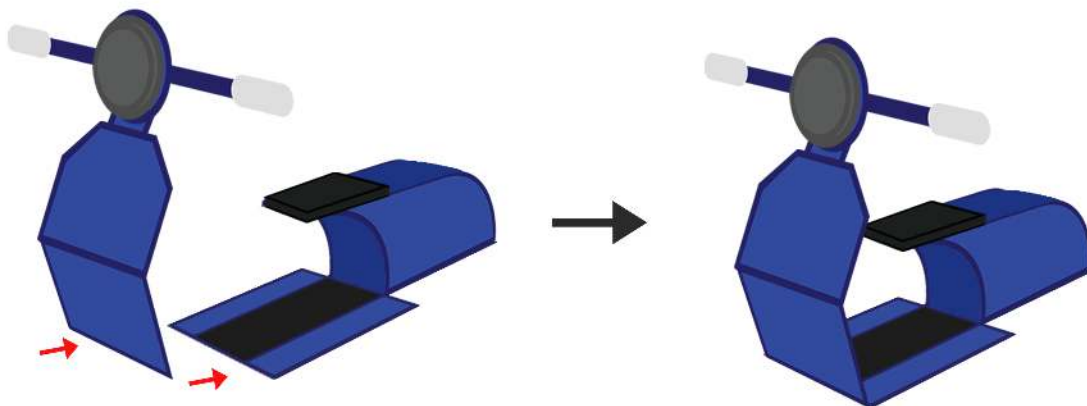
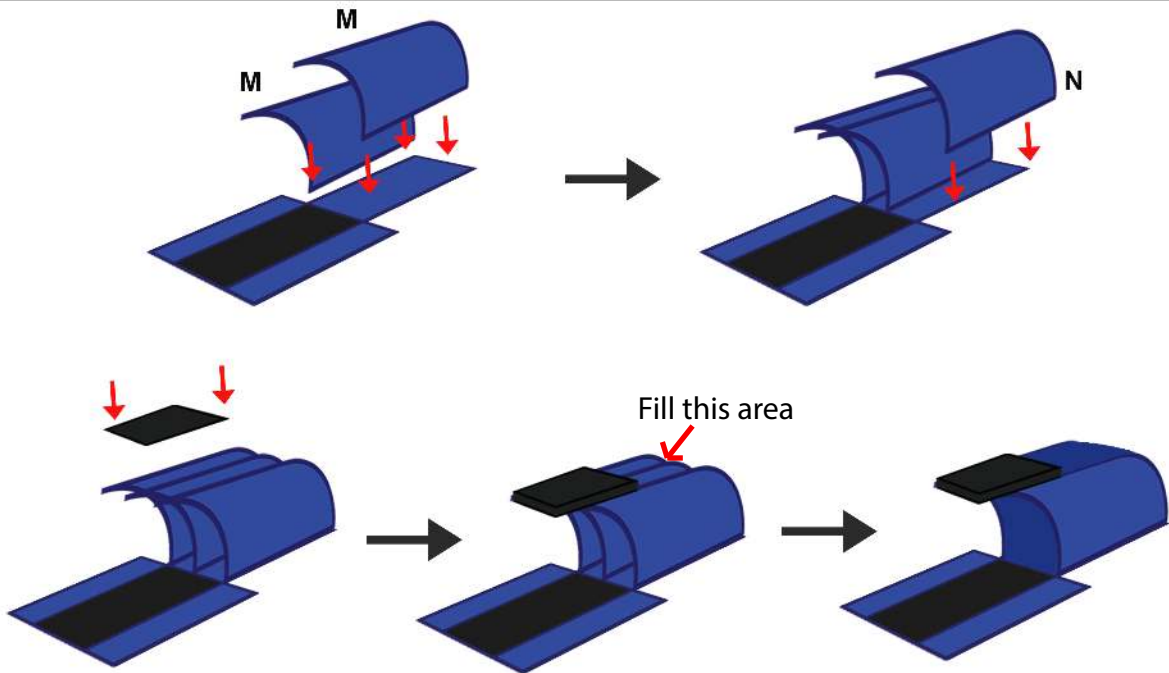
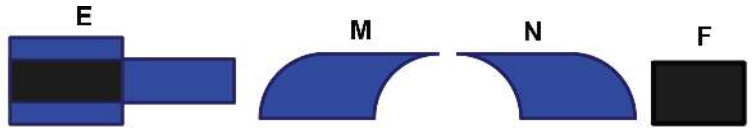

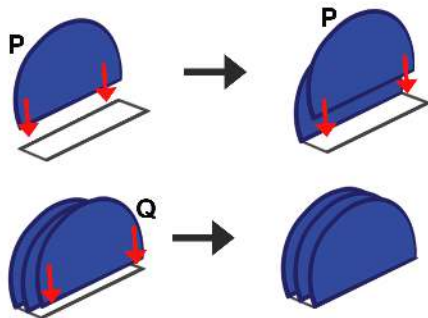
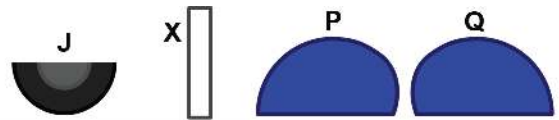

Fill this area

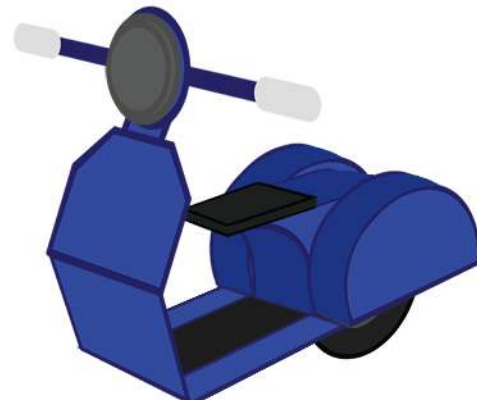
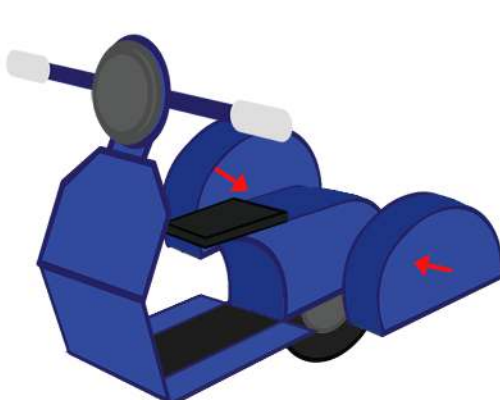
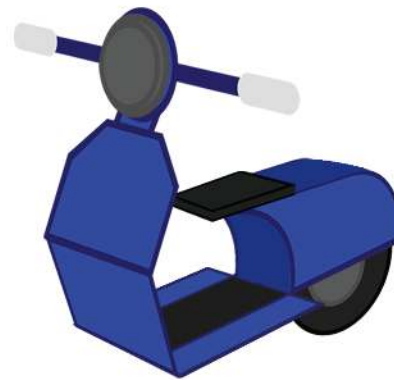
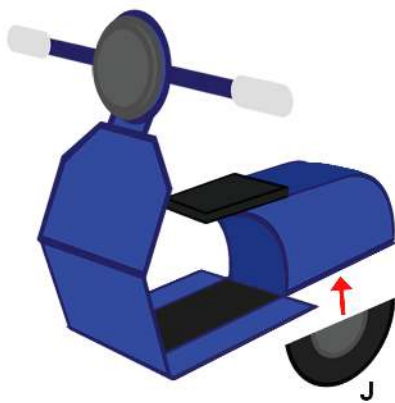
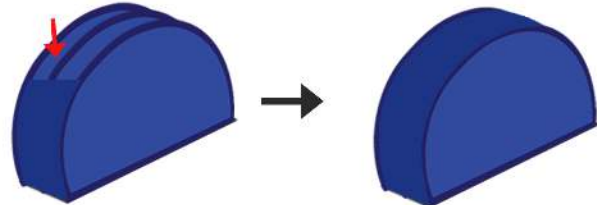

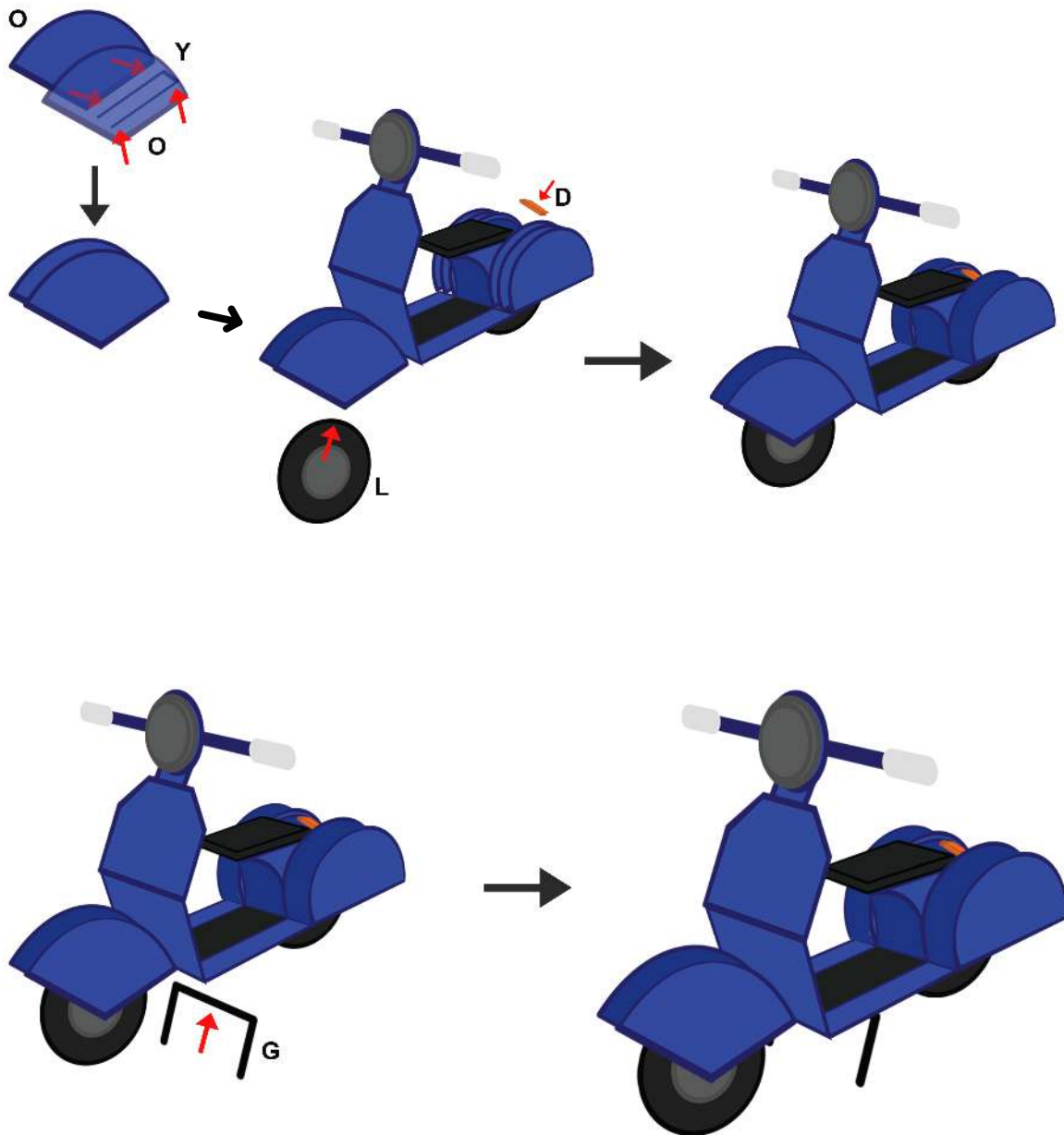
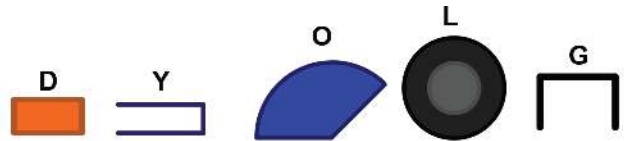



## GET INSPIRED!

Find inspirational ideas as well as tips, tricks and free downloadable stencils for the 3Dmate Design Mat, by visiting our PROJECTS page at:

[www.the3dmate.com/projects](http://www.the3dmate.com/projects) or Scan the QR code →



PROJECTS

