

GCQuad

USER GUIDE



WELCOME TO THE REVOLUTION

THANK YOU FOR CHOOSING THE GCQUAD

We listened to what you wanted - and created the most accurate, versatile and game-enhancing ball and club analysis solution available today.

The GCQuad is designed to deliver years of trusted, reliable performance. From range practice to full immersion simulation, whether for education or entertainment, the GCQuad will truly change your game.

This user manual will help you better understand the proper set-up, operation, and care of your GCQuad. Please read it carefully and refer to it should an issue arise during use. If you need more assistance, please contact our customer service team for prompt, personal attention.

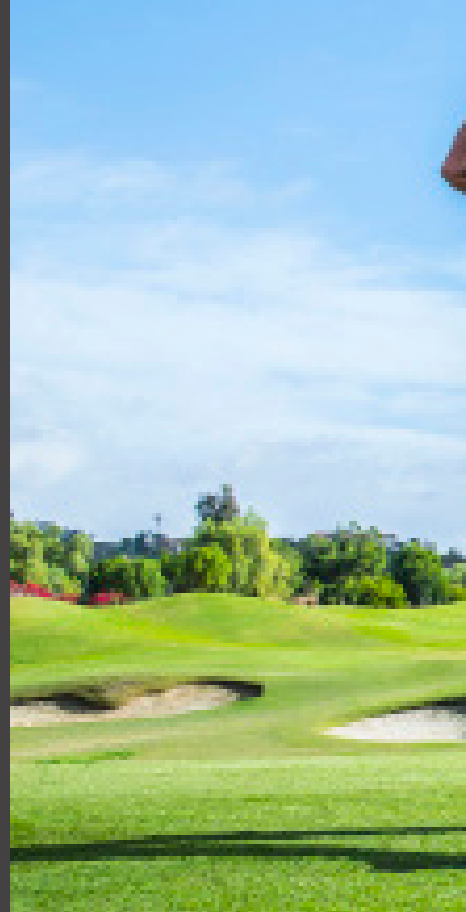



INCLUDED WITH YOUR GCQUAD PERFORMANCE PACKAGE

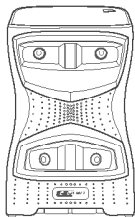

GCQuad
Quadrascopic System

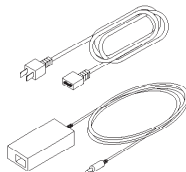

Power Adapter/Cable
Input 100-240VAC/50-60 Hz
Output 15VDC/2.4 Amps



USB Type-C
Cable

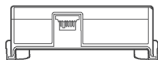

GCQuad
Lithium Battery

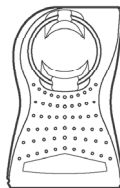

Club Marker
Dispenser



Reflective
Alignment Stick

TABLE OF CONTENTS

FEATURE OVERVIEW	01
DEVICE REGISTRATION	05
GETTING STARTED	07
SYSTEM OPTIONS	15
BALL PLACEMENT & HITTING	17
APPLYING CLUB MARKER	25
TARGET ALIGNMENT	27
CONNECTING THE DEVICE	28
BATTERY CARE	31
STORAGE & MAINTENANCE	32
SAFETY	

FEATURE OVERVIEW

FRONT

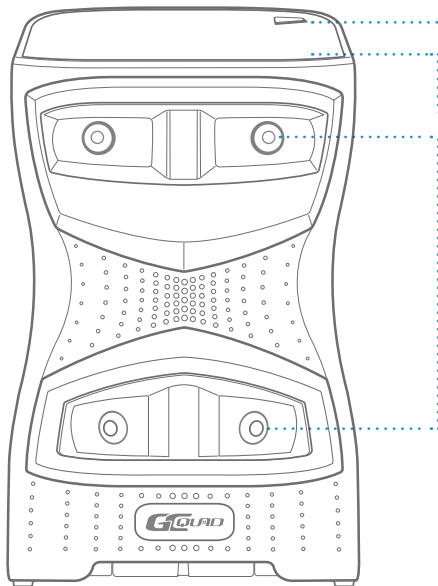

POWER BUTTON

Turns device on/off

LCD DISPLAY

Displays ball placement graphic, ball and club data, and system options menu

4 TRACKING CAMERAS

High speed cameras used for ball placement and tracking

BACK



CARRYING HANDLE

POWER LED INDICATOR

Indicates whether the GCQuad is receiving power through the power adapter

POWER PORT

Connector for the power adapter (included) to recharge the battery or to operate on external power

USB TYPE-C PORT

Connector for USB Type-C cable (included) to connect to external PC (optional)

ETHERNET PORT

Connector for Ethernet cable (not included) to connect to network or external PC (optional)

LCD DISPLAY



DISPLAY BACKLIGHT

Illuminates the display for better viewing in low light situations



BACK KEY

Return to previous screen



OK KEY

Used to access Main Menu and select system options



LEFT HANDED TRACKING

Switches GCQuad to left handed tracking mode, indicated by the blinking LED



POWER BUTTON

Turns device on/off



CURSOR KEYS



Used to toggle between ball/club data and navigate system options



RIGHT HANDED TRACKING

Switches GCQuad to right handed tracking mode, indicated by the blinking LED

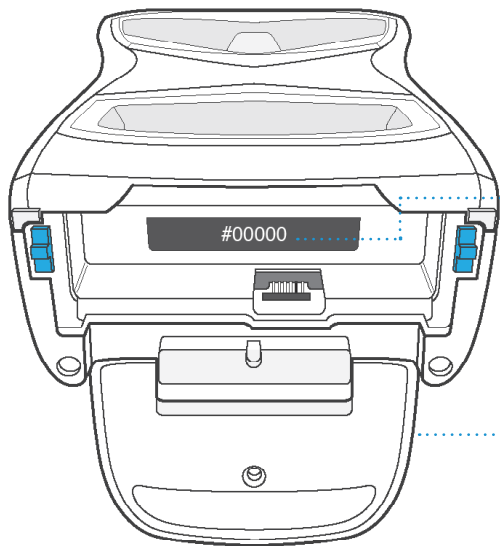

SERIAL NUMBER LABEL

Indicates product serial number, MAC address, and WiFi password

BATTERY RELEASE LEVERS

Used to release removable battery from the GCQuad

KICKSTAND

Deployed to provide stability on uneven surfaces

BATTERY

Removable lithium-ion power pack

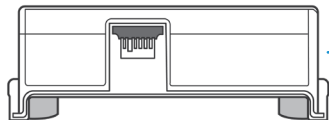

DEVICE REGISTRATION

The GCQuad requires online registration renewal every 45 days. If the registration of your device has expired, all data channels from the GCQuad (USB, Ethernet, WiFi, and BLE) will be blocked until registration renewal is completed. The GCQuad will continue to work as a stand-alone device.

To review the remaining days left until registration renewal, go to the About > Features screen.

GETTING STARTED

SETUP

To properly use the GCQuad, place the device upright on a level surface approximately 22" away from the hitting area. If a hitting mat is used, make sure the device is raised to the same level as the hitting surface. For extra stability on uneven surfaces, the kickstand can be deployed at the bottom of the unit.

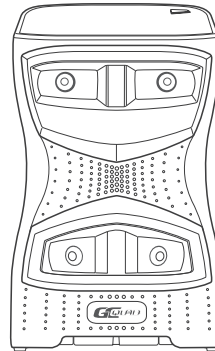

LEVEL HITTING SURFACE

POWER ON/OFF

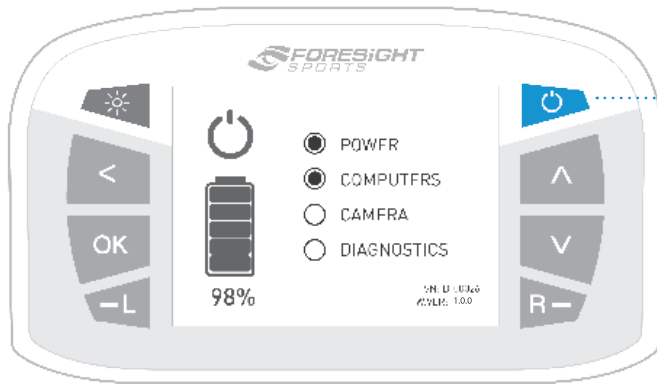

POWER BUTTON

To power on the GCQuad, press and release the power button. The device will display a start-up screen showing battery life, serial number, and firmware version. This will take approximately 30 seconds. The LED indicator will blink once the GCQuad is ready for tracking.

To power off the GCQuad, press and release the power button again. The device will initiate its shutdown sequence and the LCD screen and LED indicator will turn off.

SYSTEM OPTIONS

NAVIGATING THE MENU OPTIONS SCREEN

The GCQuad Menu Options screen is accessible by selecting the OK key. The Main Menu consists of 5 options: Club Tracking, Target Alignment, Settings, Diagnostics, and About. Use the arrow keys to select an option and the OK key to enter a screen. To return to the Main Menu from inside an options screen, or to exit the Main Menu, press the back key.

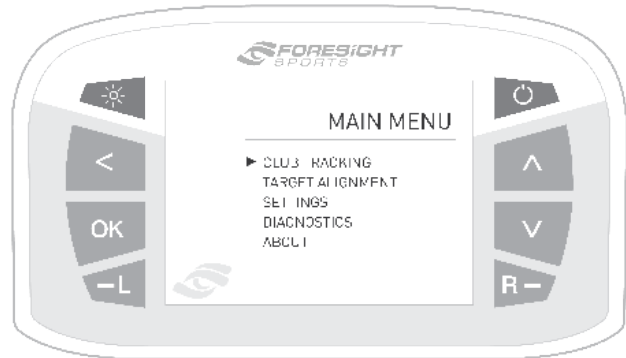



CLUB TRACKING ON

When club tracking is turned on, the GCQuad will track both the golf ball and golf club (with the club markers applied). In this mode, the device will have an LED indicator color of green and a smaller hitting zone.

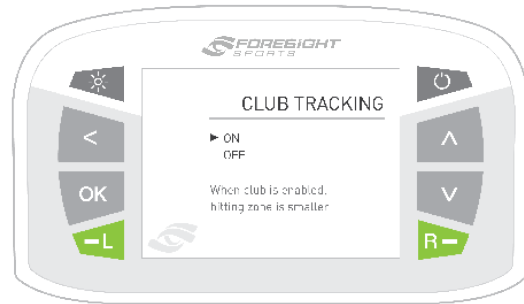

HITTING AREA (ball+club)

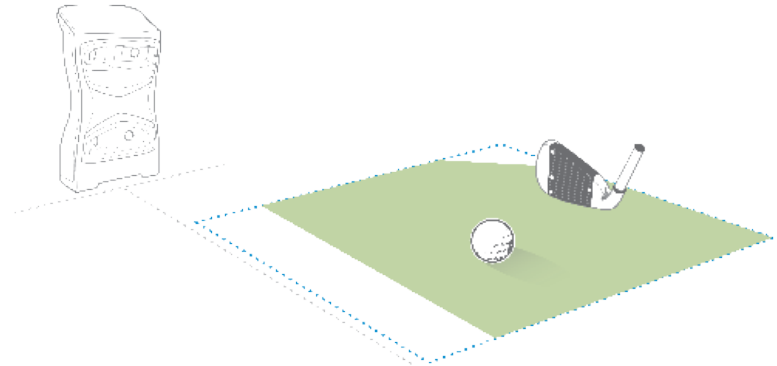

CLUB TRACKING OFF

When club tracking is turned off, the GCQuad will track only the golf ball. In this mode, the device will have an LED indicator color of blue and a larger hitting zone.



HITTING AREA (ball only)

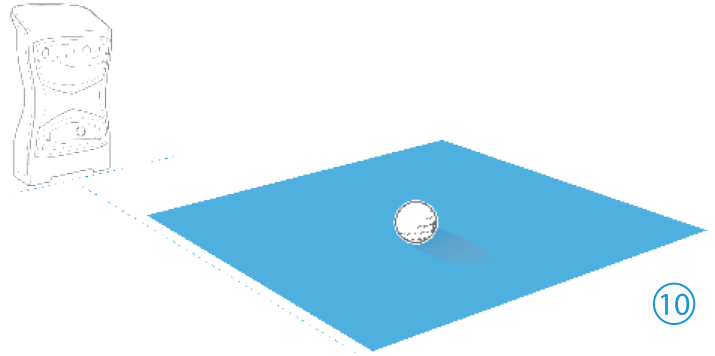

TARGET ALIGNMENT

The target alignment screen shows the current alignment configuration of the device. If alignment has been adjusted via the FSS Alignment Stick, the new alignment angle will be shown on screen.

To reset alignment to factory default, press the OK key.

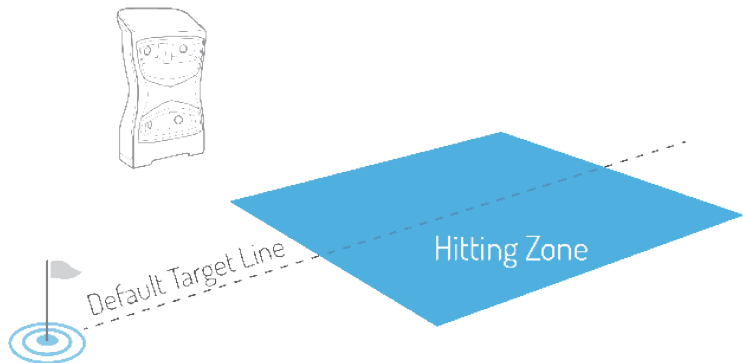
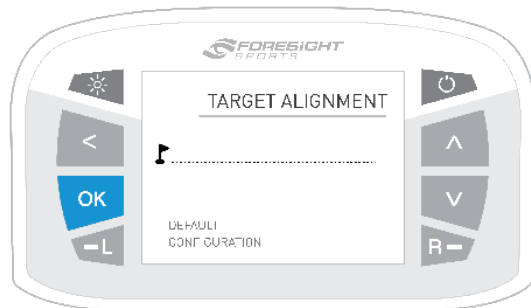

SETTINGS

Settings options can be navigated via the cursor keys and changed via the OK key. Once a setting is changed, it will be automatically saved once the screen is exited.

NEW IMAGE NEEDED

SETTING DISPLAY OPTIONS

VELOCITY

MPH | KMH | MPS

DISTANCE

YARDS | METERS

SPIN MODE

AXIS & TOTAL | SIDE & BACK

FACE ANGLE

TARGET | PATH

AIR PRESSURE

AUTO | SEA LEVEL | 2500 FT | 5000 FT | 10000 FT

DIAGNOSTICS

There are three Diagnostics screens, which can be cycled through with the arrow keys. The first (default) screen shows battery information.

Accelerometer and barometer sensor data is displayed on screen 2.

Usage information can be found on screen 3.

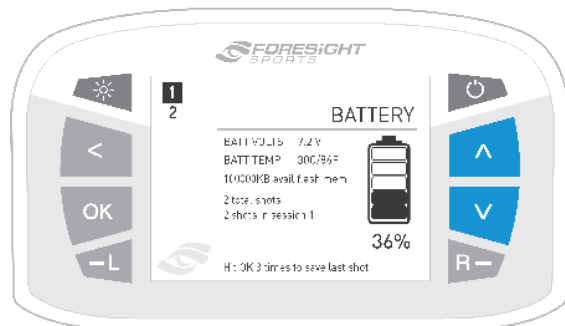

UPDATED IMAGE NEEDED

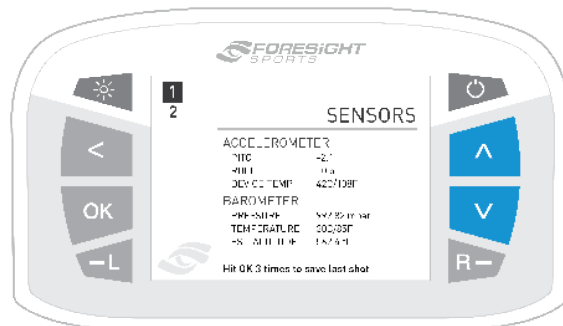

BALL PLACEMENT & HITTING

The GCQuad on-screen placement aid displays the golf ball position relative to the hitting zone. The center of the zone sits approximately 22" from the front of the GCQuad, and the zone varies in size de-pending on the mode. The zone is approximately 14" x 14" with Club Tracking enabled, and 18" x 14" with Club Tracking disabled.

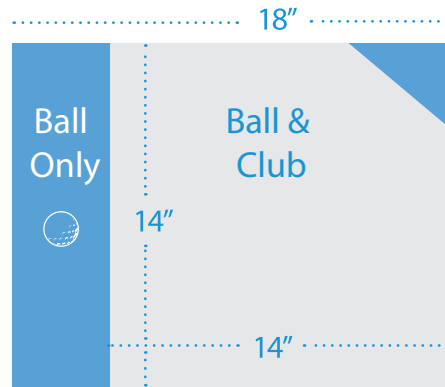
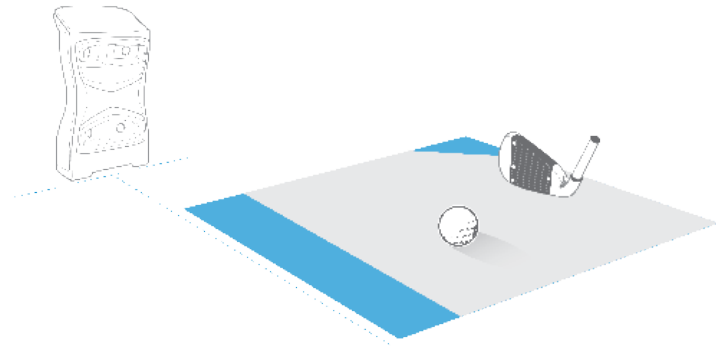

Switching between right and left handed mode can be done using the right-handed and left-handed tracking keys on the LCD screen. The current mode can be determined by the LED indicator.

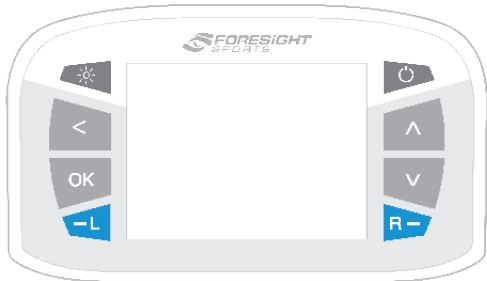

Once a ball has been located by the camera, the on-screen placement aid will appear and text will indicate one of the following device statuses.

STATUS INDICATOR

LED BLINKS SLOWLY

Previous shot data shown on screen

No ball is detected by cameras.

LED BLINKS RAPIDLY

Ball out of hitting zone

The ball is not detected in the ball find zone and must be moved inside.

Too many balls detected

More than one ball is detected in the zone, excess balls should be removed.

LED REMAINS SOLID

Ready

The ball is inside of the hitting zone and the device is ready for the shot.

APPLYING CLUB MARKERS

In order to capture club data with the GCQuad, club markers must be applied to the clubface. To apply markers using the dispenser (included):

1

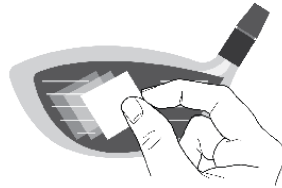

Clean the clubface with an alcohol pad or water

2

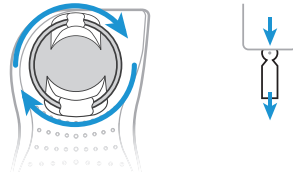

Turn the wheel clockwise to dispense a club marker

3

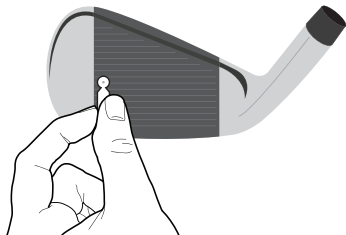

Place club marker at the desired location on the clubface, adhesive side down
(see images for correct fiducial placement)

4

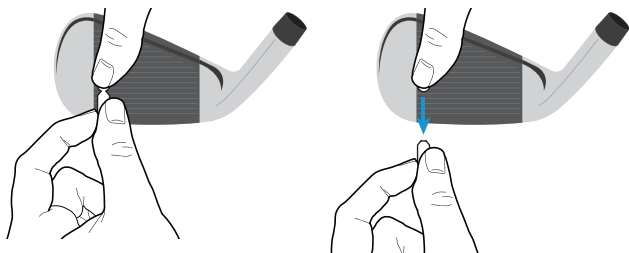

Firmly apply pressure to the marker with your finger and gently pull the tab away, leaving only the marker on the clubface



DATA CAPTURED WITH 4 MARKERS

- CLUBHEAD SPEED
- SMASH FACTOR
- ATTACK ANGLE
- SWING PATH
- FACE ANGLE
- LOFT
- LIE



DATA CAPTURED WITH 1 MARKER

- CLUBHEAD SPEED
- SMASH FACTOR
- ATTACK ANGLE
- SWING PATH

FOUR MARKER PLACEMENT FOR DRIVERS

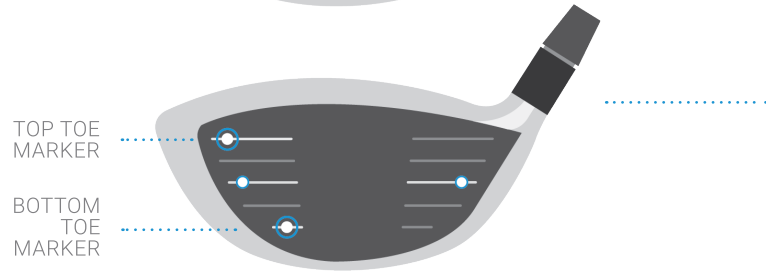
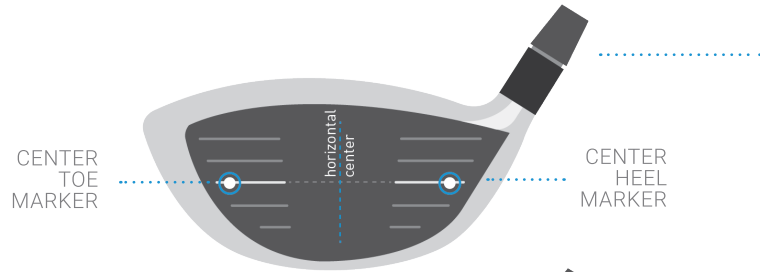
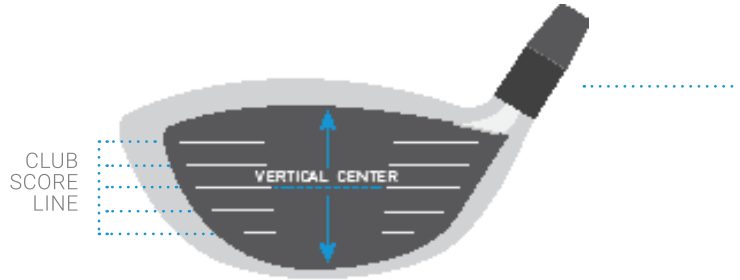



FOUR MARKER PLACEMENT FOR IRONS

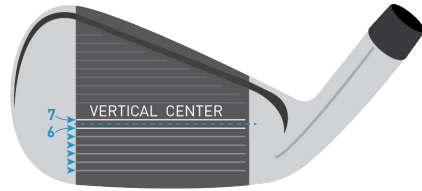

CENTER
TOE
MARKER

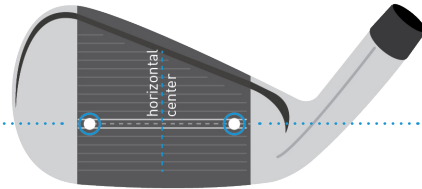

CENTER
HEEL
MARKER

TOP
TOE
MARKER

BOTTOM
TOE
MARKER

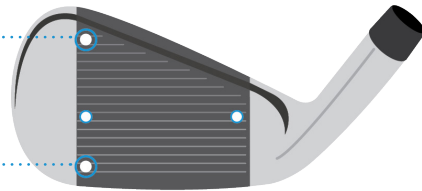

1

From the bottom of the club, count score lines up to find the approximate vertical hitting center.

2

Carefully apply the first two markers between the sixth and seventh score lines at the toe and heel, keeping both markers level with each other.*

The center point between these two markers will define the horizontal center of the face.



*Place marker about 1 marker width from the edge of the score line

3

Carefully apply the last two markers on the toe of the club face at the top and bottom edges of the ball strike zone.

SINGLE MARKER PLACEMENT

For best results, place the marker high on the clubface and as close to the horizontal center as possible.

DRIVERS FAIRWAYS & HYBRIDS

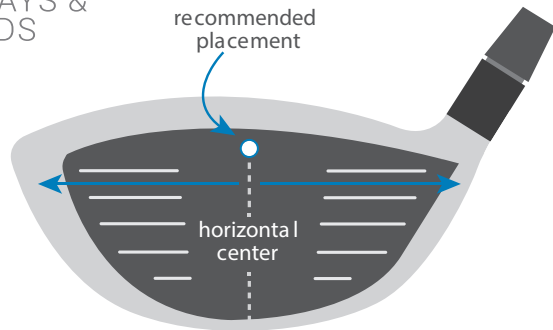

IRONS & PUTTERS

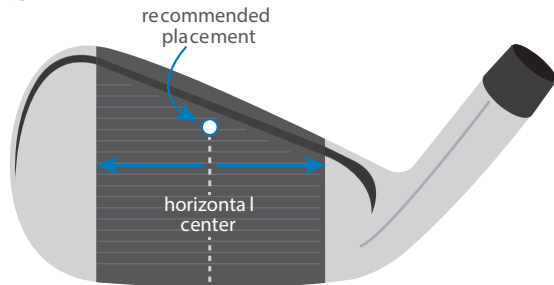



TARGET ALIGNMENT VIA ALIGNMENT STICK

Target alignment can be adjusted up to 10° on the GCQuad via the FSS Alignment Stick. To adjust alignment, place the FSS Alignment Stick in the GCQuad hitting zone and align to your target. Once aligned, step away from the device to allow for it to calibrate.

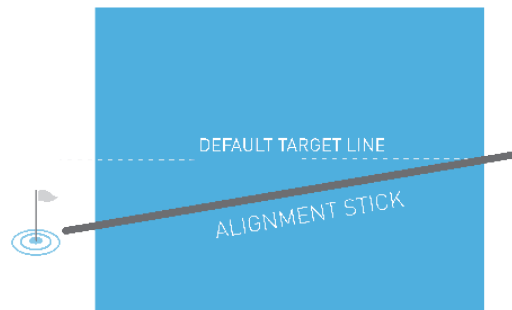
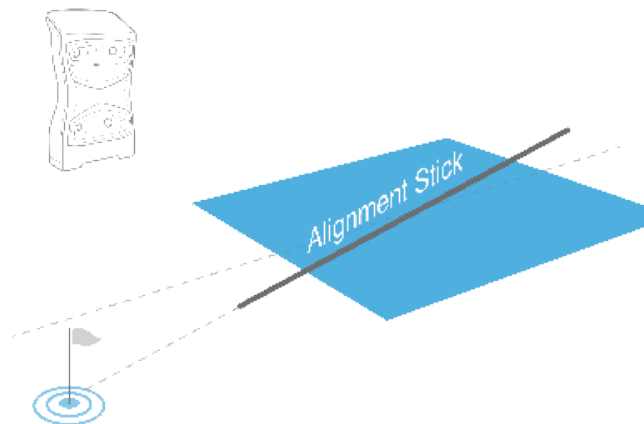

After a few seconds, both LED indicators will show yellow and the unit will give an audible tone. The new alignment angle will be shown on the LCD screen.

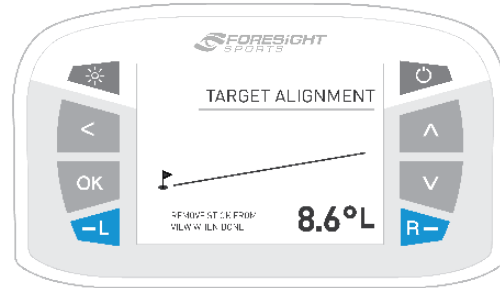

Alignment can be viewed and reset at any time from the Target Alignment menu in System Options. To reset alignment to factory default in this screen, press the OK key. Alignment is always reset when the unit is powered off.

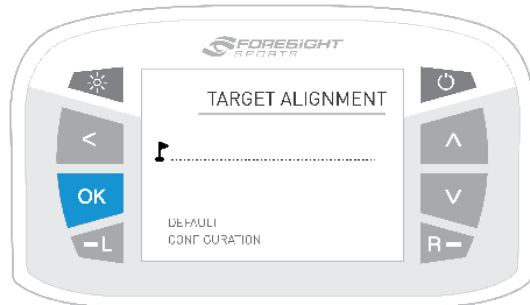

CONNECTING THE DEVICE

The GCQuad can be physically connected to other devices by USB, Ethernet, and WiFi.

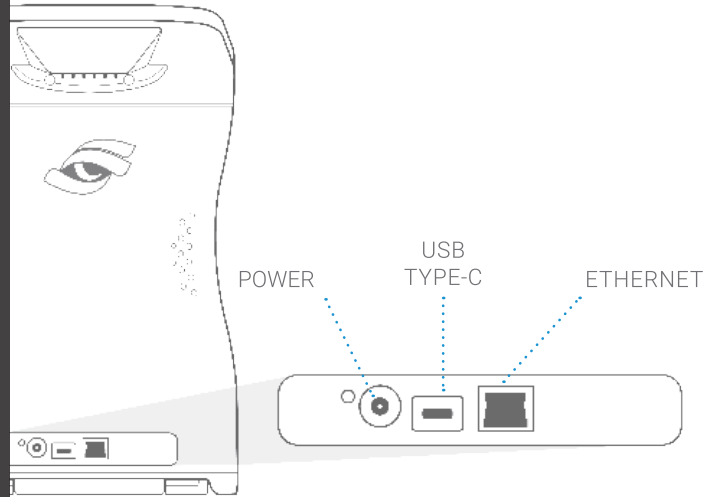

IMPORTANT! Do not use the USB Type-C or Power Cables provided on ANY devices other than GCQuad.

BATTERY CARE

REMOVING THE BATTERY

- 1 Turn the unit off and disconnect from external power source
- 2 Deploy the kickstand at the bottom of the unit to expose the battery
- 3 Firmly press on the blue battery release levers in the direction indicated on the battery
- 4 Once battery is released, gently remove from the device

NOTE: Before any type of disposal, battery should be discharged completely. Tape the contacts with electrical tape to prevent contacts accidentally coming together at any time. Recycle at an electronic waste outlet when possible. If no outlet is available in your area, it may be safe to dispose of these batteries in a trash receptacle. Check with local laws first, to make sure this is acceptable.

RELEASE
LEVERS

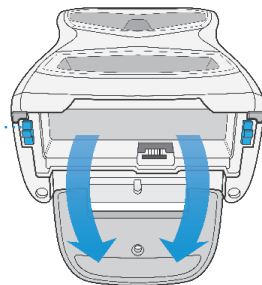

REMOVE
BATTERY

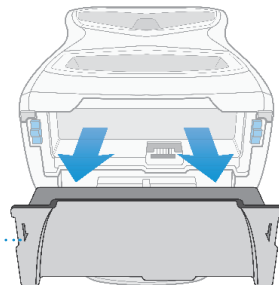

INSERTING A NEW BATTERY

- 1 With kickstand deployed, properly align battery as shown
- 2 Gently slide battery into device
- 3 Once inside, firmly press on battery to lock into place

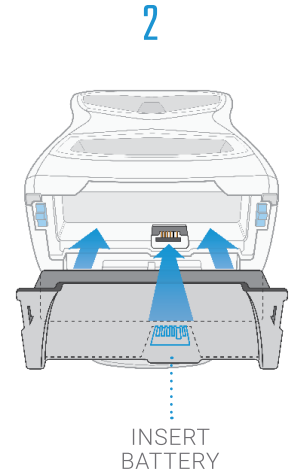
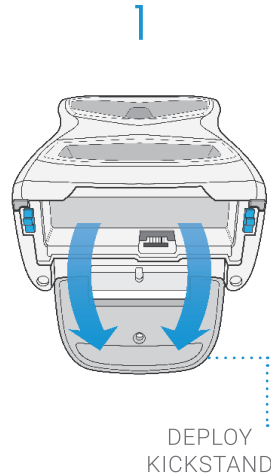

PROPER BATTERY CARE

The battery in your GCQuad has been designed to provide safe, reliable operation. However, the life of your GCQuad battery and its ability to hold an adequate charge is dependent upon a regular routine of fully discharging and recharging the battery. Without regularly performing this discharge/recharge routine, the GCQuad battery life expectancy can be compromised significantly.

3

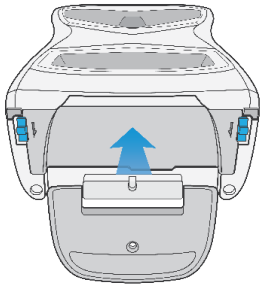

LOCK
BATTERY

IMPORTANT! Your GCQuad battery should be fully discharged and recharged at least once a month. This includes batteries in storage, as well as batteries in GCQuad devices operating on continuous AC power.

Failure to abide by this routine may cause the battery to lose its ability to recharge or hold an adequate charge, and will require replacement at the customer's expense.

STORAGE AND MAINTENANCE

HOW TO STORE THE GCQUAD

Prior to storing the GCQuad, always make sure the device is powered off and the battery is removed. Foresight Sports strongly recommends storing the GCQuad in a cool, dry environment in its original foam-lined packaging or specially designed carrying case to prevent damage.

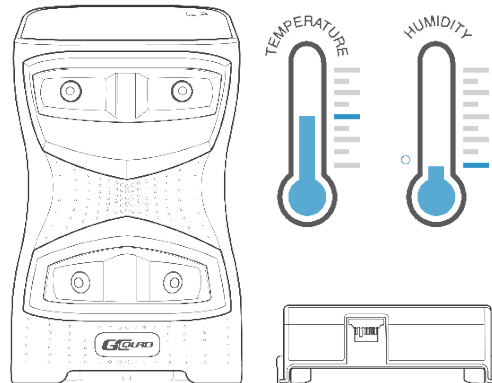

SAFETY

- If foreign objects or water has entered the device, disconnect the device from external power, turn the power off, and remove the battery. Continued use in this state can cause fire or electric shock.
- DO NOT disassemble, change, or attempt to repair the device. This could result in electric shock and will void the manufacturer's warranty.
- DO NOT use this device in environments where high humidity, smoke, or dust is present.
- To avoid possible injury, DO NOT look directly into the device when it is turned on.
- The GCQuad has been designed to withstand ball impact. However, if the device enclosure or LCD display has been damaged due to a ball impact or for any other reason, turn power off and discontinue use.
- Use only the power adapter and battery pack that came with the device. Using any other power adapter, charger, or battery pack may cause damage to the GCQuad or battery, and may cause fire or injury.
- The GCQuad uses four digital cameras that are precisely calibrated. Do not drop or subject the device to any impacts that may cause shock.
- After use, always store the GCQuad in a safe, dry, and dust-free environment.





QUESTIONS?

We're here to help. For product related issues or questions, please contact our customer support team at 858.880.0179 or online at support@foresightsports.com

© 2016-2017 Foresight Sports

Foresight Sports may have patents, patent applications, trademarks, copyrights, or other intellectual property rights covering subject matter in this document. Except as expressly provided in any written license agreement from Foresight Sports, the furnishing of this document does not give you any license to these patents, trademarks, copyrights, or other intellectual property.

