



User Manual

**FCC Statement:** Changes or modifications not expressly approved by FlightScope (Pty) Ltd could void the user's authority to operate the equipment. This equipment has been tested and found to comply with the limits for a Class B digital device, pursuant to part 15 of the FCC rules. These limits are designed to provide reasonable protection against harmful interference in an office or residential installation. This equipment generates, uses and can radiate radio frequency energy and, if not installed and used in accordance with the instructions, may cause harmful interference to radio communications. However, there is no guarantee that interference will not occur in a particular installation. If this equipment does cause harmful interference to other electronic equipment, which can be determined by turning this equipment off and on, the user is encouraged to try to correct the interference by one or more of the following measures: Increase the separation between the equipment causing and experiencing the interference. Install a radio frequency shield between the equipment causing and experiencing the interference. Consult your dealer for help.

**This device complies with Part 15 of the FCC Rules. Operation is subject to the following two conditions:**

- [1] This device may not cause harmful interference.
- [2] This device must accept any interference received, including interference that may cause undesired operation.

**IC Statement:** This device complies with Industry Canada license-exempt RSS standards. Operation is subject to the following two conditions: [1] this device may not cause interference, and [2] this device must accept any interference, including interference that may cause undesired operation of the device.

**Declaration IC:** Le présent appareil est conforme aux CNR d'Industrie Canada applicables aux appareils radio exempts de Licence. L'exploitation est autorisée aux deux conditions suivantes: [1] l'appareil ne doit pas produire de brouillage, et [2] l'utilisateur de l'appareil doit accepter tout brouillage radioélectrique subi, même si le brouillage est susceptible d'en compromettre le fonctionnement.



me•vo

[mēvō] *noun*

**m**easure your numbers

**e**valuate your game

**v**isualize your improvement

**o**ptimize your performance



## Contents

<b>In the Box</b>	<b>1</b>	<b>Charge</b>	<b>18</b>
<b>The Radar</b>	<b>2</b>	<b>Noise</b>	<b>19</b>
<b>Indicators</b> (Battery & System)	<b>3</b>	<b>Care</b>	<b>22</b>
<b>Get App</b>	<b>5</b>	<b>myflightscope.com</b>	<b>23</b>
<b>First Time Setup</b>	<b>6</b>	<b>Support</b>	<b>24</b>
<b>Session</b>	<b>9</b>	<b>Technical Specs</b>	<b>25</b>
<b>Golf Data</b>	<b>15</b>		

## In the Box

- 1 Mevo
- 2 USB charging cable
- 3 Metallic stickers\*
- 4 Pouch
- 5 Manual

\* Optional, see page 11

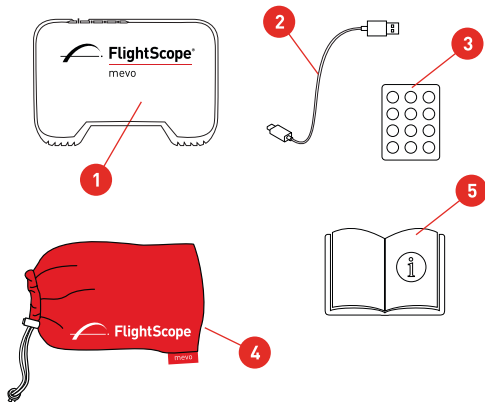

## The Radar

- 1 Lights
- 2 USB
- 3 Kickstand
- 4 Power button
- 5 Tripod mount

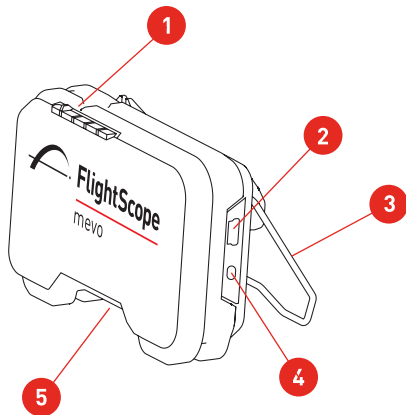

# Battery Indicators

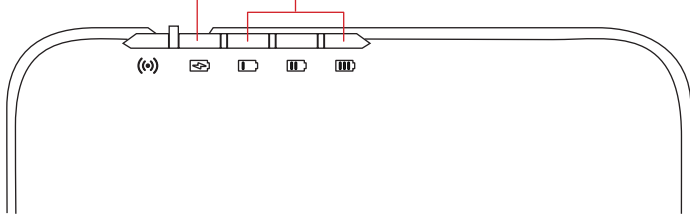
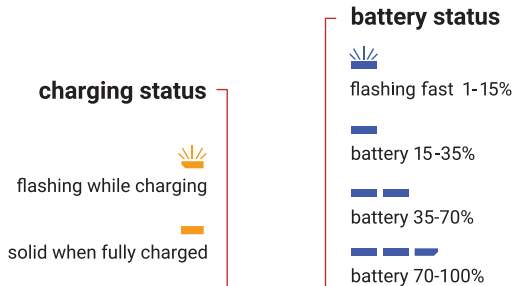

## System Indicators

### radar status



quick flash when idle



slow flash when idle



flashing red & orange  
when armed

### bluetooth status



flashing when waiting for connection



solid when connected

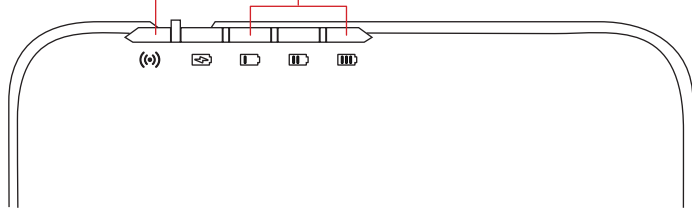



## Get the App

Download the Mevo App  
from the App Store  
or Google Play



Your username and password will  
be the same on myflightscope.com

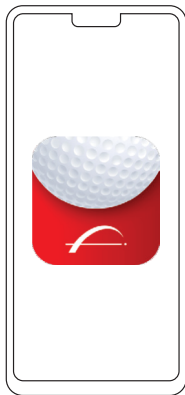

# First Time Setup

1

Download and install the Mevo App onto your mobile device.

Make sure your mobile device's bluetooth is set to on.

Make sure your mobile device and Mevo are fully charged before getting started.

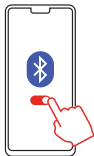

2

Open the Mevo App on your phone and log in or sign up.



In the Mevo App, locate the QR code scanner.

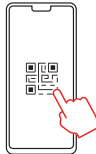

3

Press the power button on the Mevo. The battery indicators will begin to flash.

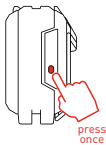

4

Using the in-app QR code scanner, scan the QR code on the back of your Mevo to connect.

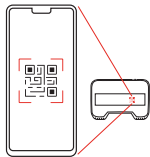

When the battery lights are solid blue, Mevo and your device are connected.



5

You are now ready to start using your Mevo.

Open the kickstand and place behind your tee position (see page 9).



6

When finished with your session, switch off the Mevo by pressing and holding the button until all the indicators are off.

Visit [myflightscope.com](http://myflightscope.com) to review saved sessions and track performance.

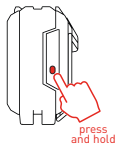

## Session

Place Mevo **6ft** (1.8m) behind the hit position.

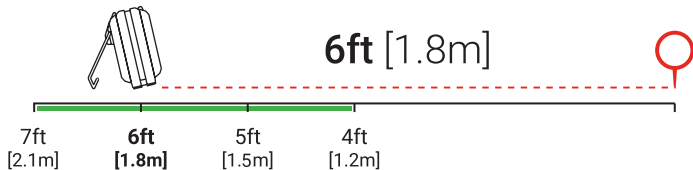

Recommended setup position is 6ft behind the tee. Setup position may be as short as 4ft for smaller spaces. For high swing speed, radar should be moved back to 7ft.

Keep area between Mevo and the tee clear of any objects and people.



To enjoy optimal spin accuracy, place a metallic sticker on the ball, which ensures spin accuracies only attainable by scientific instruments.

**Spin accuracy without a metallic sticker is well within acceptable levels.**

1



Place a metallic sticker on the ball.

To order additional stickers: go to [flightscope/product-category/accessories/](https://flightscope.com/product-category/accessories/)

When using a metallic sticker on a ball, aim the metallic sticker away from the radar.

2

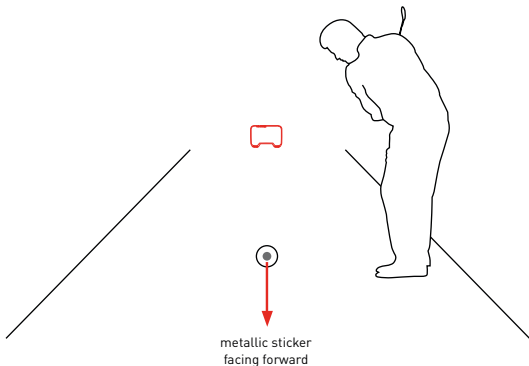



For accurate tracking, Mevo must be level with the launch position.



Extremely low and wide shots, and shots that pass behind the player might not be displayed.

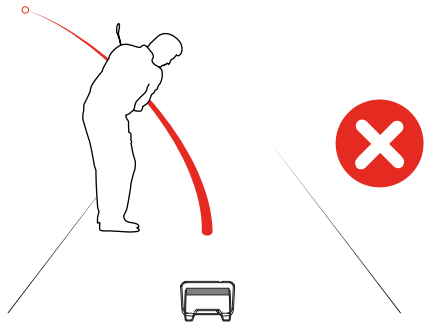

## Data

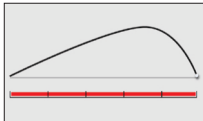

### Carry Distance

The landing distance of the ball from the tee.

Knowing your carry distances allows you to work on consistency and club gapping with every club in the bag.



### Club Speed

The speed of the club measured at impact with the ball.

Improve distance and spin control by learning how to make more controlled swings when needed. Club speed has the biggest effect on ball speed.

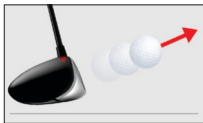

### Ball Speed

The launch speed of the golf ball.

This is directly determined by club speed and quality of strike. Higher club speed does not necessarily mean higher ball speed if the ball is not hit correctly. Ball speed has the biggest effect on carry distance.

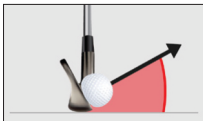

## Vertical Launch

The angle at which the ball is launched relative to the horizontal plane.

Knowing this helps improve optimal launch angles for different clubs in various shot & weather scenarios.

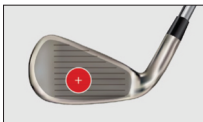

## Smash Factor

This is the ball speed divided by the club speed

This indicates the quality of the strike. Higher club speed does not necessarily mean higher ball speed. Striking in the 'sweet' spot of the club - the higher the ratio, the better the strike.



## Spin Rate

The number of rotations per minute of the ball at launch.

Spin rate has a major influence on carry distance and apex height of a shot. Learn how to control your shots by understanding your spin rate. Spin also effects the ball's behavior when it lands producing rolling &/or stopping depending on spin rate.

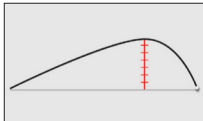

## Apex Height

The height from the ground at the highest point of the shot.



## Flight Time

The amount of time the ball spends in the air, measured in seconds.

## First Time Setup

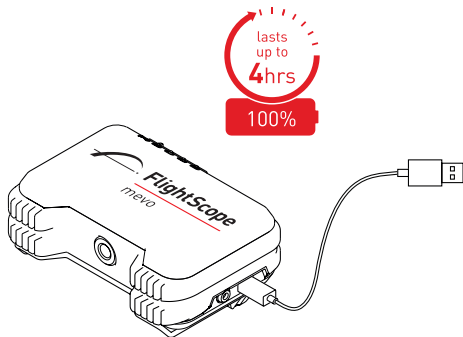

Use the cable provided to charge your Mevo.  
Connect to a suitable USB socket or charger.

With 5V output, charge for  
2 hrs for a full charge



OR



With a PC desktop or laptop,  
charge for 2hrs for a full charge

## Noise

Mevo is a sensitive measuring instrument designed to operate in most environments. However, certain things in the background can create noise that can interfere with tracking

**Some common noisy objects are:**



aircon



fluorescent  
lights



fans



tv's, laptops &  
desktop computers



fridges



signal  
towers

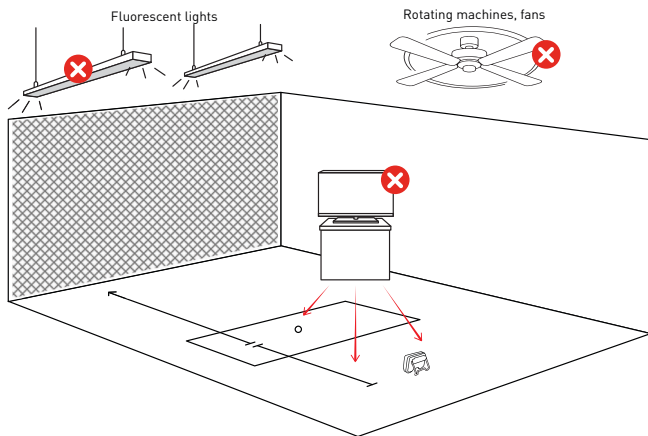



Keep area clear of possible noise interference. Make sure to move electronic devices behind Mevo as far as practical.

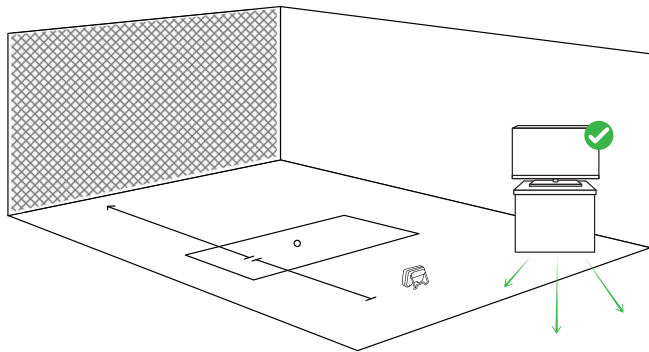

## Care

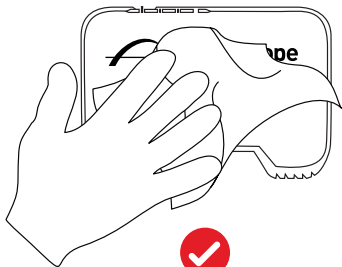

Clean with  
damp cloth

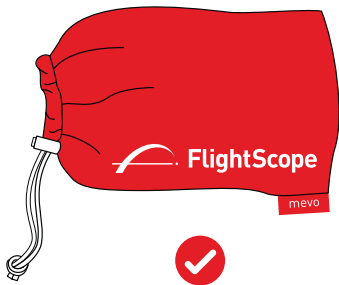

Store in pouch  
when not in use

## Performance tracking

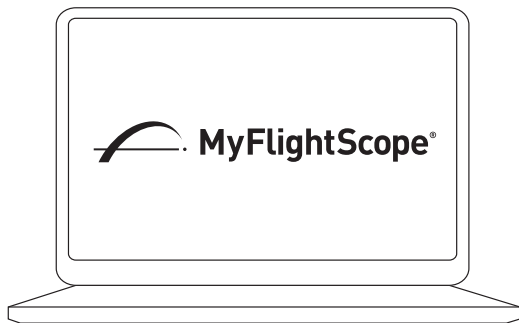

Go to **myflightscope.com** to track your performance

## Support

**Need more help?**

---

support@flightscopemevo.com

## Technical Specifications

### transceiver

operating frequency	24.125 GHz (nominal). Fixed factory-set frequency in 24.075 - 24.175 GHz range (US/FCC)*
output power (EIRP)	14 dBm (25mW) typical
antenna gain	20 dBi (+/- 2dB)
carrier modulation	CW/None (NON)
detection method	doppler velocity measurement

### bluetooth

operating frequency	2.4 GHz
output power	-20 dBm to +4 dBm in 4 dB steps

### electrical, physical, and general

operating temperature	0° C to +40° C / 32° F to 100° F
dimensions	Approx. 90 x 70 x 30mm / 3.55" x 2.76" x 1.18"
mass	Approx. 200g / 7oz
power supply	5 V DC +/- 5%; current <1 A, 500mA or more
data interfaces	Bluetooth® Low Energy