



# DIY ENCLOSURE KIT 10'4" x 7'11" x 5'

LOVE THE GAME  
INSIDE & OUT



# THANKS!

Thank you for your purchase of a golf simulator impact screen and DIY enclosure kit! This assembly guide is designed to help you find everything you need to complete your new enclosure kit and a few helpful tips to ensure that you have the best indoor golf experience. Play well and have fun!



# CONTENTS

<b>Specifications &amp; Safety</b> .....	<b>1</b>
<b>What's Included</b> .....	<b>2</b>
<b>Overview of DIY Enclosure</b> .....	<b>2</b>
<b>What's Not Included</b> .....	<b>3</b>
<b>Cutting Poles</b> .....	<b>5</b>
<b>Frame Assembly</b> .....	<b>6</b>
<b>Enclosure Assembly</b> .....	<b>9</b>
<b>Golf Impact Screen Care and Use</b> .....	<b>14</b>

# SPECIFICATIONS

<b>Enclosure Dimensions</b>	10'4"(W) x 7'11"(H) x 5'(D)
<b>Materials</b>	Pipe Connectors: Steel Black Surround Material SIGPRO Premium Impact Screen
<b>Weight</b>	117 lbs
<b>Color</b>	Black Surround / White Screen
<b>Screen Viewable Dimensions</b>	9'4"(W) x 6'10"(H) x 11'7" Diagonal
<b>Recommended Space Requirements</b>	We recommend a room width of at least 10.5 feet, room depth of 16 feet and a ceiling height of at least 9 feet.

# SAFETY INSTRUCTIONS

- » We recommend at least two people setting up this enclosure.
- » Please make sure to take proper safety precautions and keep children, pets, and spectators out of swing range.
- » Additionally, take every precaution to protect ceilings, walls, windows, cars, and neighboring homes.
- » Be alert of where you stand or walk and stay out of someone's swing path
- » Make sure the setup is far from gas, electric heater, fireplace, candles, or any other similar source of heat.
- » When not in use, store neatly in a cool dry location, protected from sunlight
- » We are not responsible for damage to property &/or personal injury.
- » Be mindful of potential falling pipe if not tightened properly.
- » Do not hang from the enclosure.

# WHAT'S INCLUDED

- (1) Enclosure Surround
- (1) SIGPRO Premium Impact Screen
- (1) 6" Ball Bungees - 80 Qty
- (4) Protective Foam Pads
- (1) Allen Wrench
- (11) Pipe Connectors (w/ set screws included)

# ENCLOSURE OVERVIEW



# WHAT'S NOT INCLUDED

## Pipe Frame

(9) 10 Foot EMT Pipe

\* Cut Sizes for Pipe \*

(4) 1" EMT Pipe at 91-1/4"

(6) 1" EMT Pipe at 58-15/16"

(4) 1" EMT Pipe at 56-3/8"

# TOOLS NEEDED

- Ladder
- Marker / Sharpie
- Pipe Cutter / Chop Saw / Mitre Saw
- Tape Measure

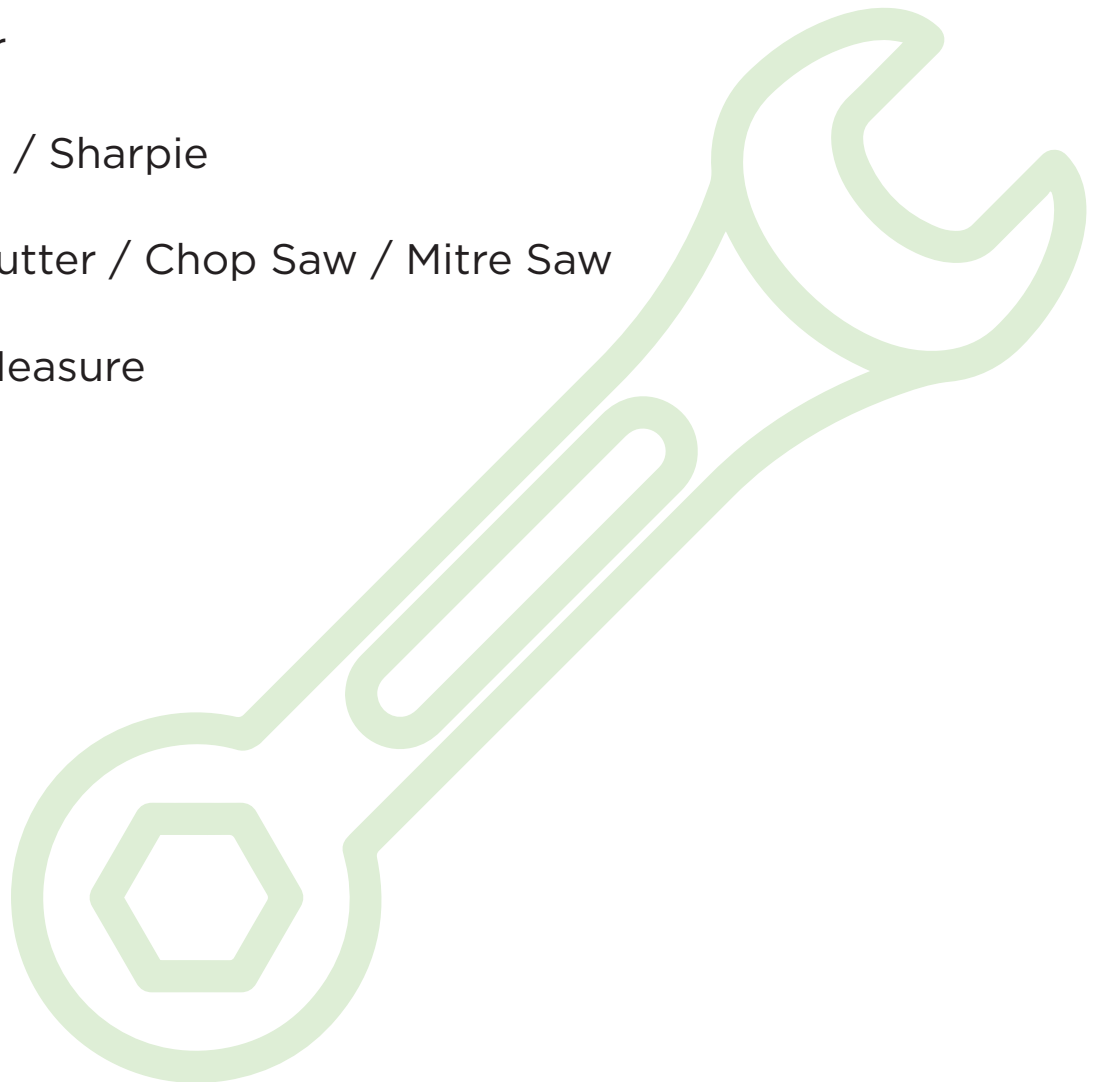

# ENCLOSURE DIAGRAM

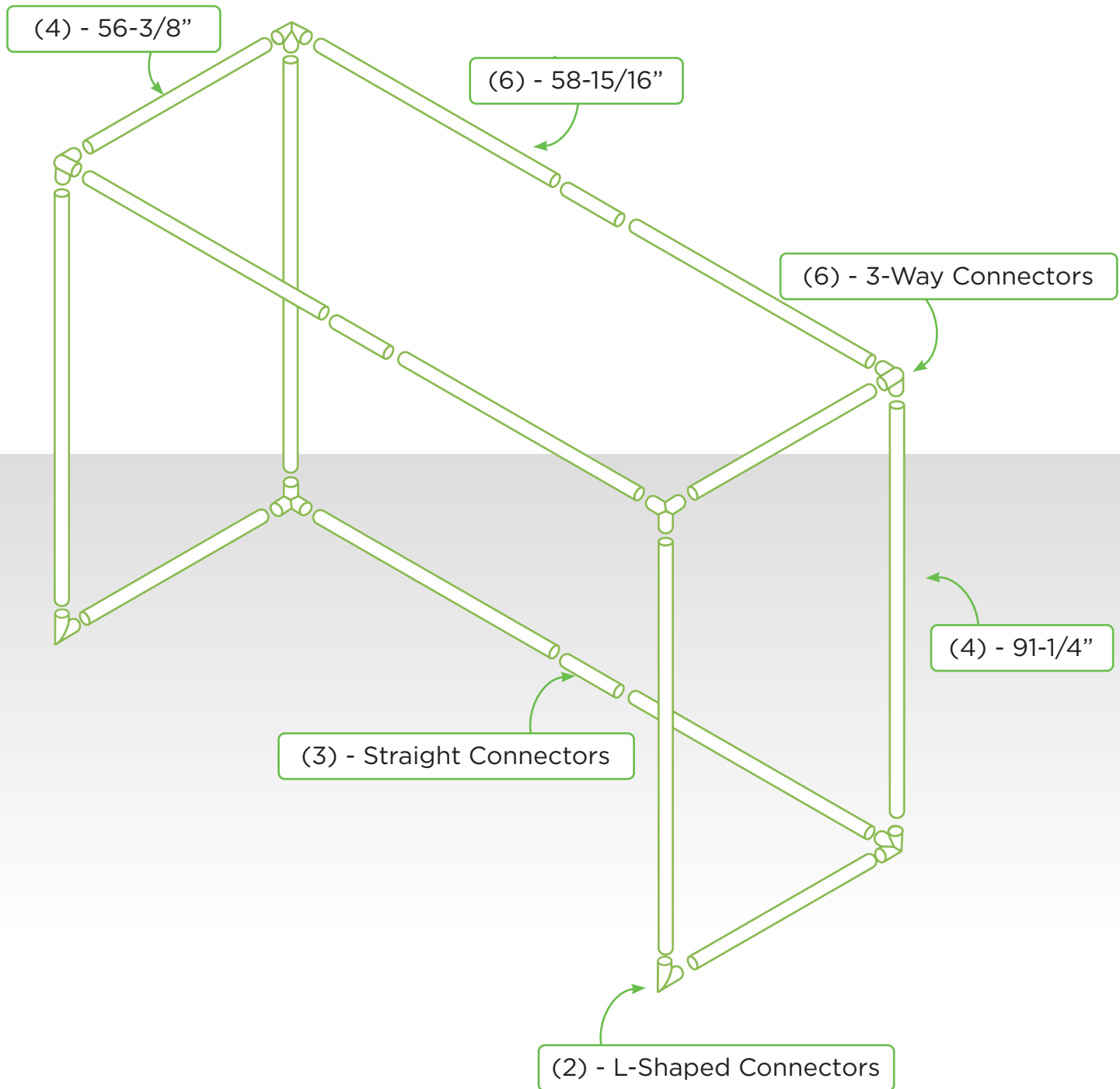

# CUTTING POLES

After purchasing (9) 10-foot EMT Pipe from your local home improvement store, you will want to start measuring and marking the poles before making any cuts.

## STEP 1

Using a mitre saw or a pipe cutting tool, cut down each of the pipes to the listed size below

### CUT SIZES

(4) at 91-1/4"  
(6) at 58-15/16"  
(4) at 56-3/8"



## STEP 2

Once pipes are cut to length, use a marker to draw a line 4 inches from the end of each pipe. This will guide you as you insert each pipe into a connector.

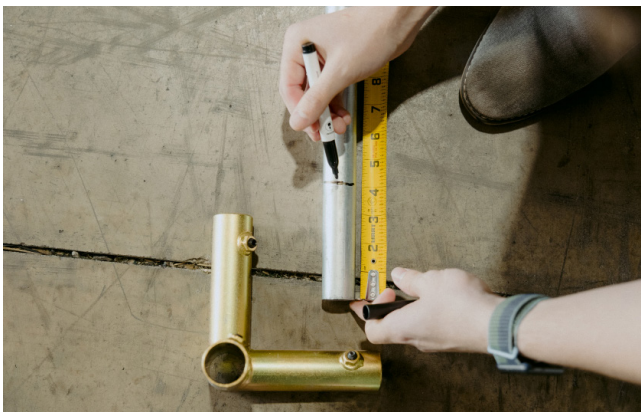

## STEP 3

When attaching connector pieces, slide the pipe into each connector to where the line has been drawn. This will ensure every pipe is inserted 4 inches inside each connector.





# FRAME ASSEMBLY

**Note:** Insert pipes 4 inches into each connector and then tighten the set screw with the included Allen wrench. This step will be repeated throughout the Frame Assembly Portion of this manual.

## STEP 1

Join (2) of the 58-15/16" pipes with (1) straight connector. Then attach (2) 3-way connectors on each end of the 58-15/16" pipes. Tighten the set screws.

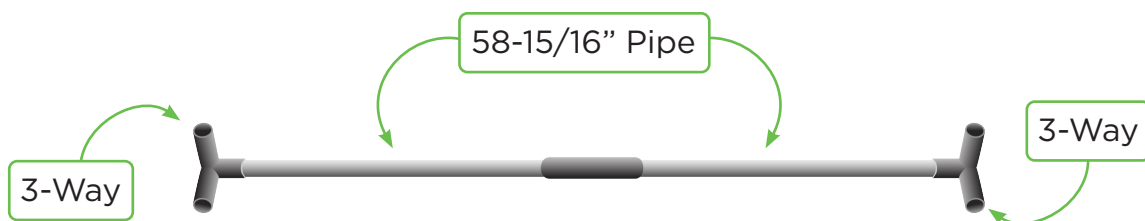

## STEP 2

Now insert (2) 56-3/8" pipes into the left and right side of the frame as shown below.

## STEP 3

Connect L-shaped connectors to the left and right of the frame as shown in the image below. Tighten the set screws.

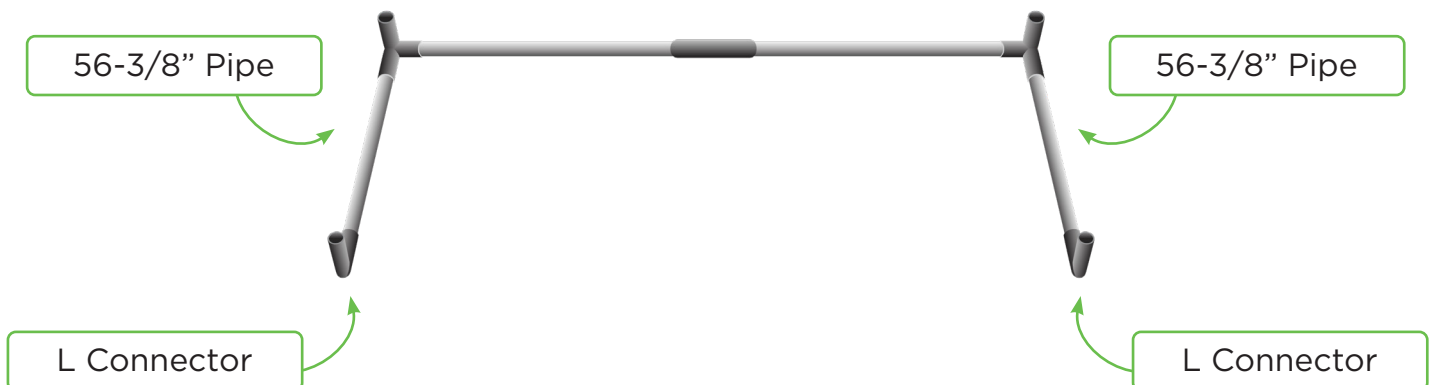

# FRAME ASSEMBLY

## STEP 4

Connect the 91-1/4" pipes vertically to all four sides of the frame as shown in the image below. Tighten the set screws.



## STEP 5

Connect the 3-way connector pieces at the top of all vertical pipes of the frame as shown in the image below. Tighten the set screws.

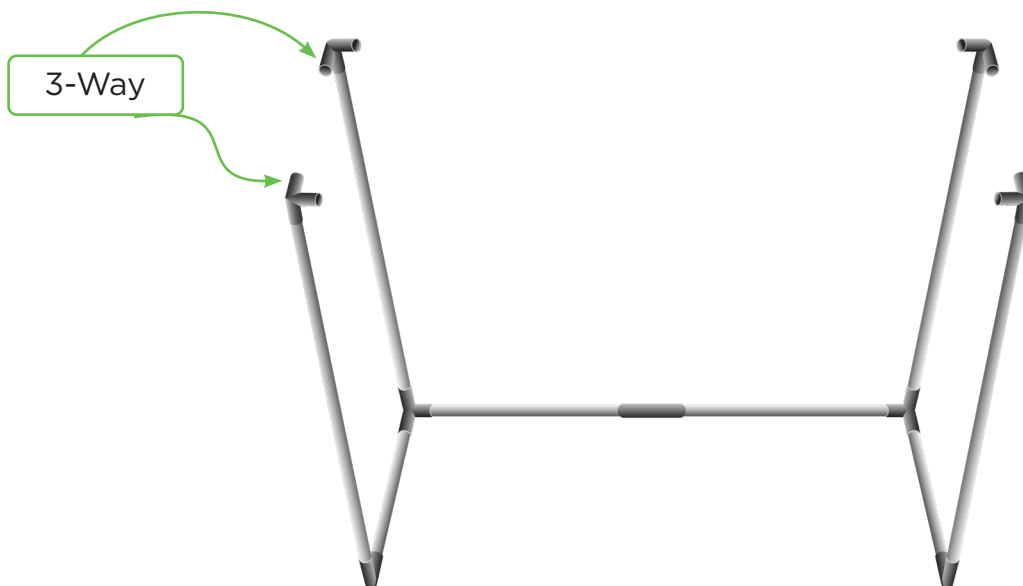

**Note:** Do not over-tighten set screws with force. Tighten enough so that you feel or hear slight click.

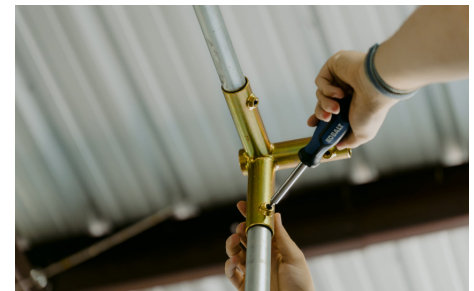

# FRAME ASSEMBLY

## STEP 6

Join the remaining 58-15/16" pipes with the straight connectors. Then add the completed long pipes to the front and back of the frame using the 3-way connector opening. Tighten the set screws.

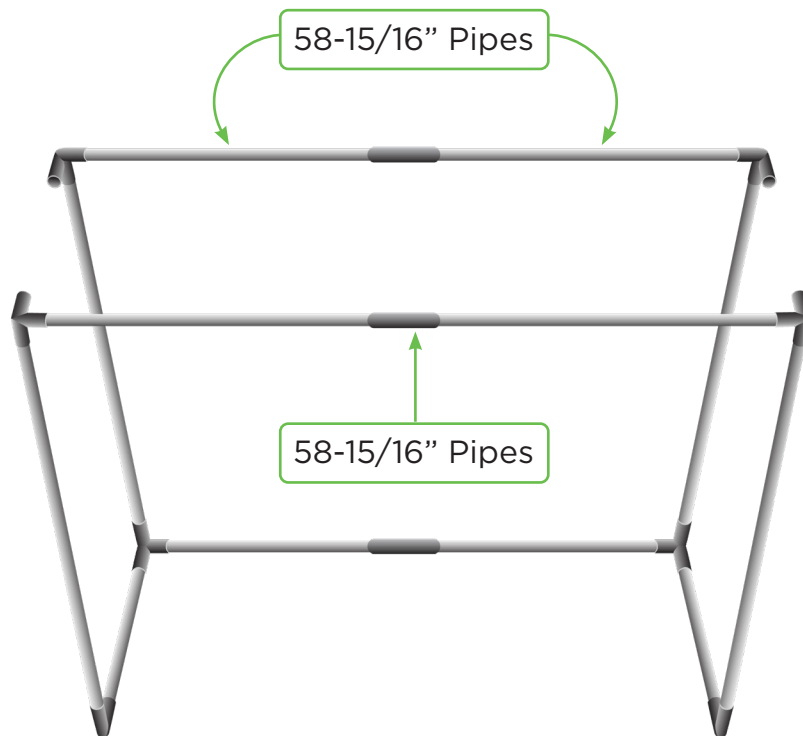

## STEP 7

Finally, connect the 56-3/8" pipes to the top left and right sides of the frame. Tighten the set screws.

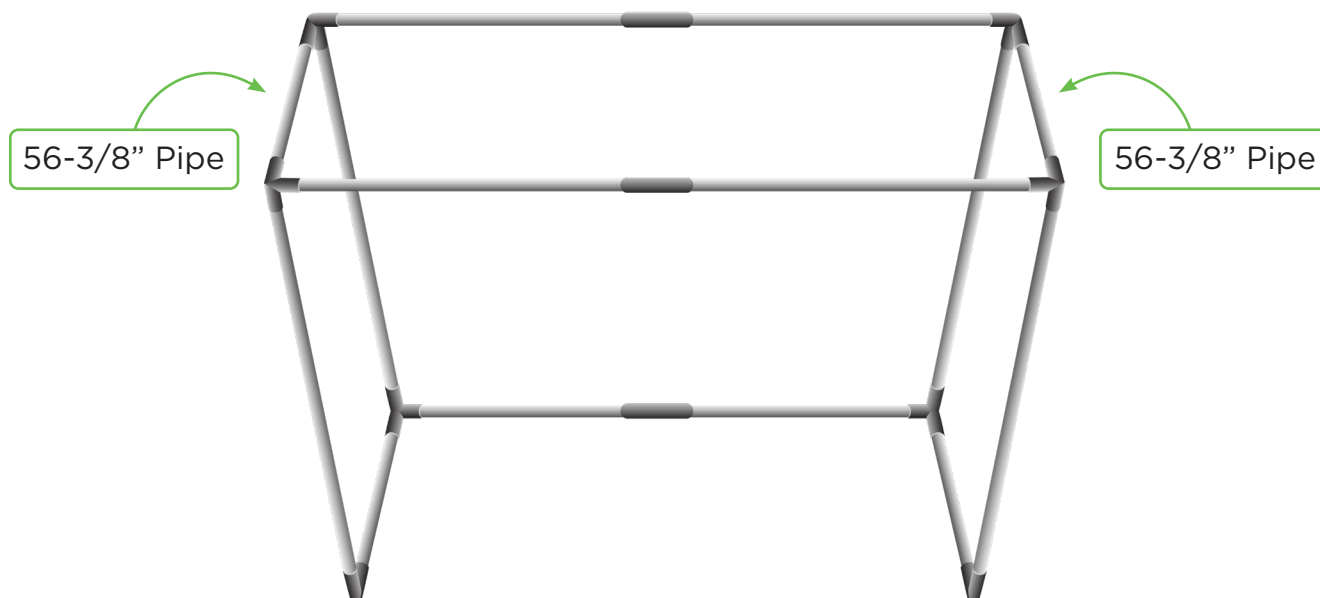

# ENCLOSURE ASSEMBLY



## STEP 1

Unfold the black surround and place it over the top of the completed frame. The black surround should be placed to where the grommeted edges are in the back of the frame and the Velcro strips are towards the front.

## STEP 2

Make sure the interior flap in the upper corner lines up with the upper cross bar. This flap will secure the top of the surround to the frame.



## STEP 3

Unfold the flap in both top corners and let it hang (do not secure velcro) until you complete the steps 4 and 5 on the next page. **Note:** The Indoor Golf Shop logo should be at the golfer's left.

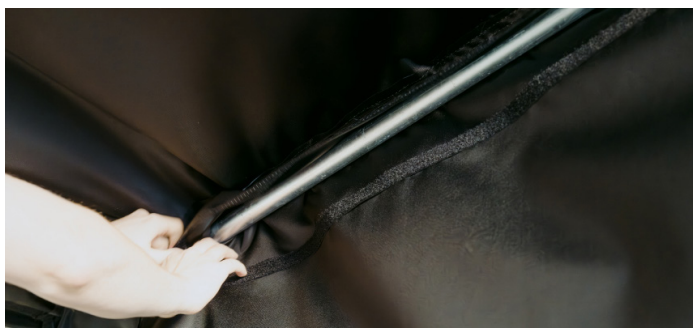

# ENCLOSURE ASSEMBLY

## STEP 3

With the black surround in place, move to the bottom and pull the flap underneath the pole on each side. Pull so the side of the black surround is tight and then secure the velcro flap around the pole.



## STEP 4

Move to the front vertical poles and repeat the previous step by pulling the flap around the pole and securing the velcro.

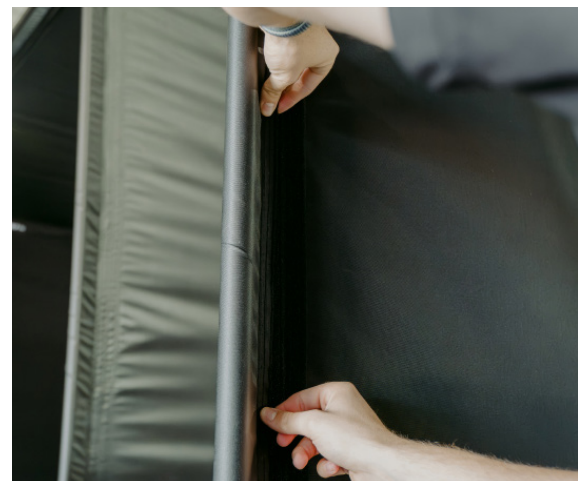



# ENCLOSURE ASSEMBLY



## STEP 5

Repeat the flap process across the top bar making sure that the bar is covered and the velcro is securely fasten.

**Note:** Once all velcro flaps are secure, run your hand over the covered poles to smooth the black surround for less wrinkles

## STEP 6

With the bottom secure, the front vertical flaps secure, and the crossbar flap in place, move to the top inside corners.

Press the velcro flap that covers the top inside corner poles and secure with the velcro strips.

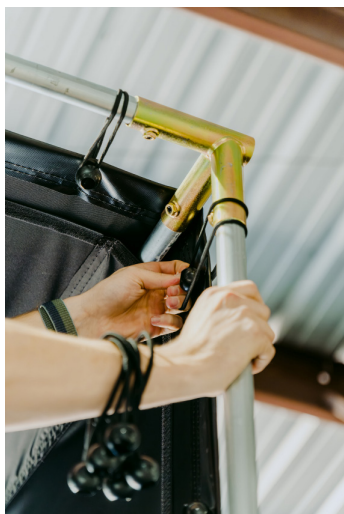

## HELPFUL TIP

You will now move on to securing the black surround and impact screen to the frame with bungee balls. To eliminate having to reach for bungee balls and reduce the amount of going up and down on the ladder - create a bungee ball bracelet around your wrist to speed up this process.

# ENCLOSURE ASSEMBLY



## STEP 7

Start securing the black surround to the frame with the provided bungee balls. The surround will be pulled tight during this step.

**Note:** Position the balls so that they are on the outside of the enclosure.

## STEP 2

Once the black surround has been secured to the enclosure frame with the bungee balls, it is time to unfold and hang the impact screen. **Note:** Handle the screen with care. Make sure your hands are clean when touching the screen and avoid dragging it across the floor. Unfold the screen so that the velcro strips are facing towards the golfer. Find a top corner and use that as your starting point to secure the screen with a bungee ball. This process is easiest with two people.

## STEP 6

Continue attaching the impact screen to the enclosure frame with the provided bungee balls. Remember to position the balls to the outside of the enclosure.

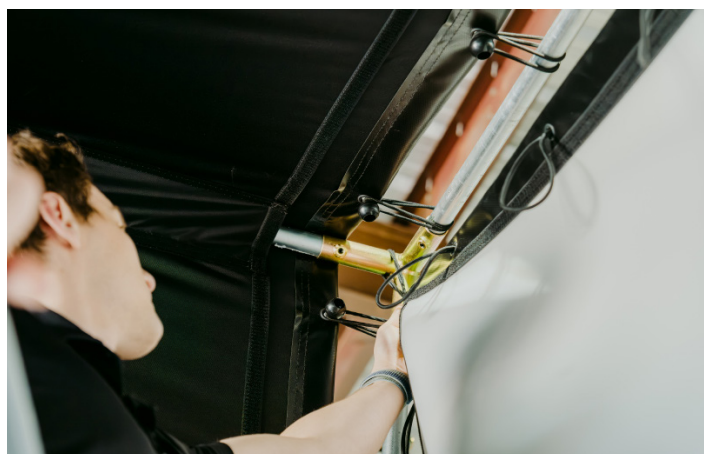

# ENCLOSURE ASSEMBLY



## HELPFUL TIP

When attaching the impact screen to the bottom pole, use a solid object under the pole to provide enough clearance and space to run the bungee balls around the pole.

## STEP 6

Once the impact screen has been secured to the enclosure, remove the protective black strips along the top, bottom and sides of the screen to reveal the velcro.

You will now attach the foam pads to the screen and enclosure creating a “picture frame” around the impact screen

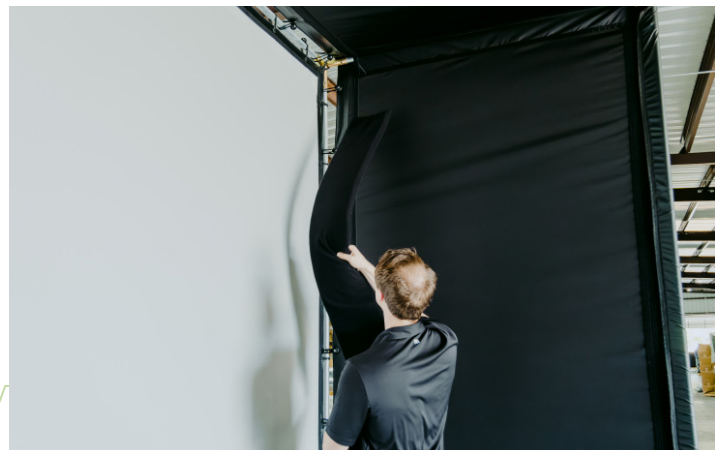



# IMPACT SCREEN CARE & USE

- » If you feel that your screen is being stretched too tight, try removing bungees first. If it is still too tight adjust the pipe in the canopy fittings.
- » Keep enough space between the screen and any walls behind it to avoid contacting them. This distance will depend on the force of your swing, but in most cases 6-12” is sufficient.
- » We recommend using new golf balls that are free from any scuffs or permanent markers to maximize the life of your screen.
- » Clean your clubs and golf balls regularly to keep your screen clean.
- » Remember that impact screens are “wearable” products, and depending on the individual user, they may start showing wear immediately after first use. This is normal. All of our impact screens, however, should withstand several thousands of strikes from even the best golfers.
- » Always make sure your screen is completely clean and dry before storing to avoid spots, mold, or mildew.

# ***WE WELCOME YOUR FEEDBACK!***

Please feel free to contact us if you have any questions or comments about using your new products.

We can be reached on our website, via email, or by giving us a call at **972-848-7491**.

Please don't hesitate to let us know if there is anything we can do to help!