

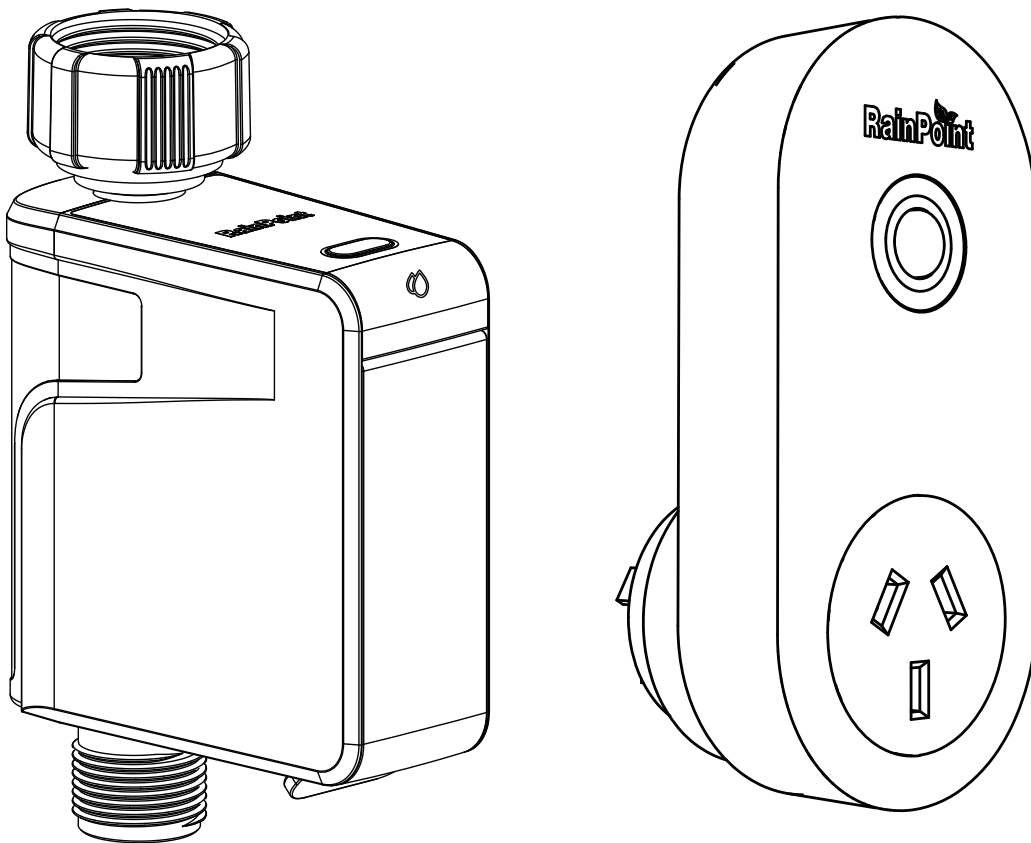

WiFi WATER TIMER SYSTEM

USER MANUAL

TTV107WRF & TWG004WRF



Thank you for purchasing our products.
If you have any questions, please contact us.

WEB: www.rainpointus.com
Email: service@rainpointus.com
Phone: 833 3815659 (US Office)



www.rainpointus.com

Email: service@rainpointus.com

Phone: 1-833-381-5659 (US Office)

Thank you for the purchase of the Rainpoint WiFi Water Timer System!

After using Rainpoint products, you'll find it easier, faster and more convenient than ever before! You are able to schedule, manually operate, auto watering and monitor flow just with your smart phone. When the timer is connected to the hub and your WiFi, it can synchronize the weather forecast from internet to automatic update and adjustment your watering plan. The timer works much like other Wi-Fi devices: as long as your phone can access the internet , you can connect the device and control your timer no matter where you are.

Let's start to enjoy the wonderful smart irrigation life!

For more product information and user guide please visit:

YouTube Channel: Rainpoint

Facebook Page: @Rainpointpromote

Welcome to Rainpoint WiFi Water Timer System

A. Product Overview

- 1) TTV107WRF Watering Timer
- 2) TWG004WRF Wi-Fi Hub
- 3) Rainpoint App Home Page

B. Features Overview

C. Getting Start

- 1) Power the Wi-Fi Hub & Timer
- 2) Initial RainPoint App Setup
- 3) Pair with Wi-Fi Hub
- 4) Pair with WiFi Watering Timer
- 5) Install the Timer on the Faucet
- 6) Turn on your water

D. Program Your Timer on APP

- 1) Parameter of your timer
- 2) Manual Watering
- 3) Watering on Schedule
- 4) Intelligent Automatic Watering
 - Sensor Control*
 - Water Flow Meter*
 - Tap-to-Run & Automation
- 5) Rain Delay (Watering Delay)
 - Manual Rain Delay
 - Automatic Rain Delay
- 6) Co-management with family

E. Troubleshooting

F. Warning & Warranty

G. Getting Help

*This product set is not equipped with a sensor.

*Rainpoint Wi-Fi hose faucet timer has a built-in water flow meter.

A. Product Overview

1) TTV107WRF Watering Timer

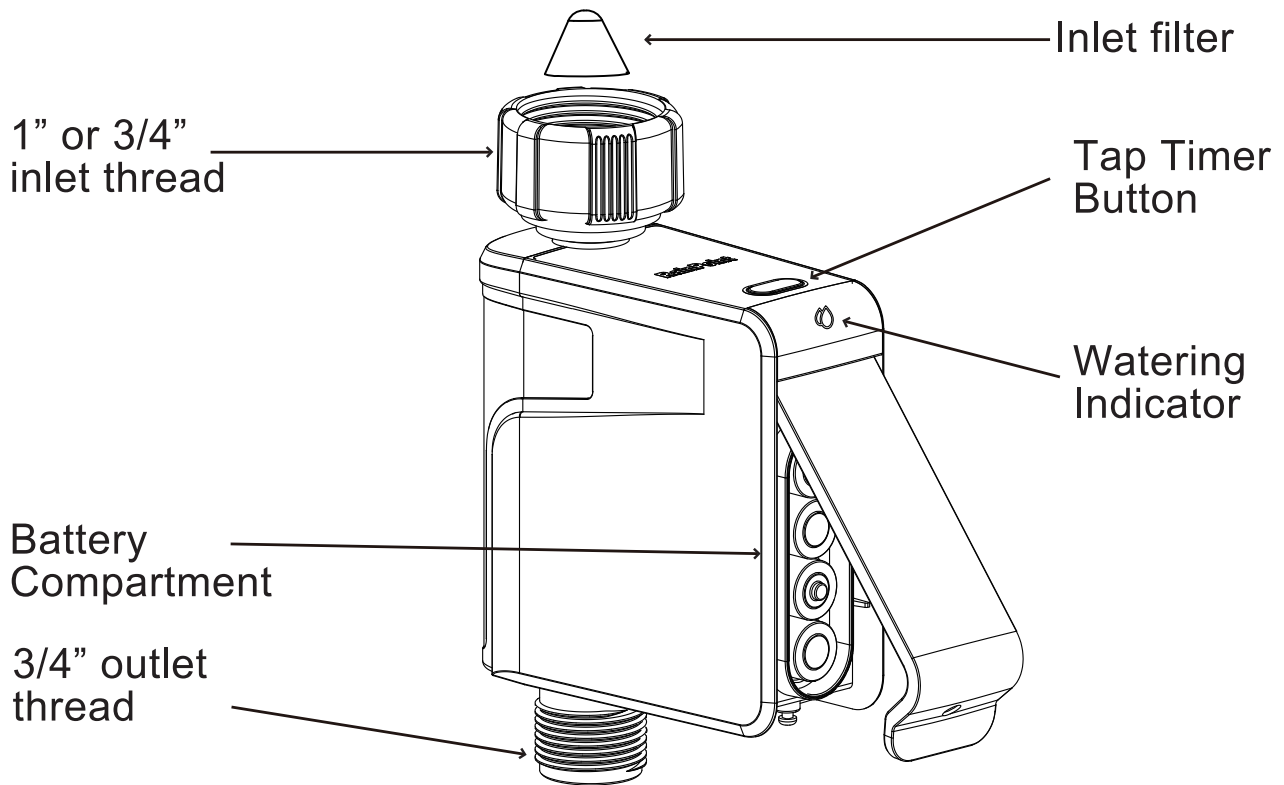

Range: 200 ft in the open area without interference from the hub

Working water pressure 0.5 to 8 bar(7.25-116PSI)

Temperature Operating Range: 32°F-122°F (0-50°C)

Power by: 4 AA batteries (not included)

Water Proof: IP54

⚠ WARNING

For outdoor use with cold water only.

Keep away from freezing. Under freezing weather, the timer should be removed from the tap to avoid the danger of freezing.

Used up or dead batteries must be removed from the timer and disposed of properly.

2) TWG004WRF Wi-Fi Hub

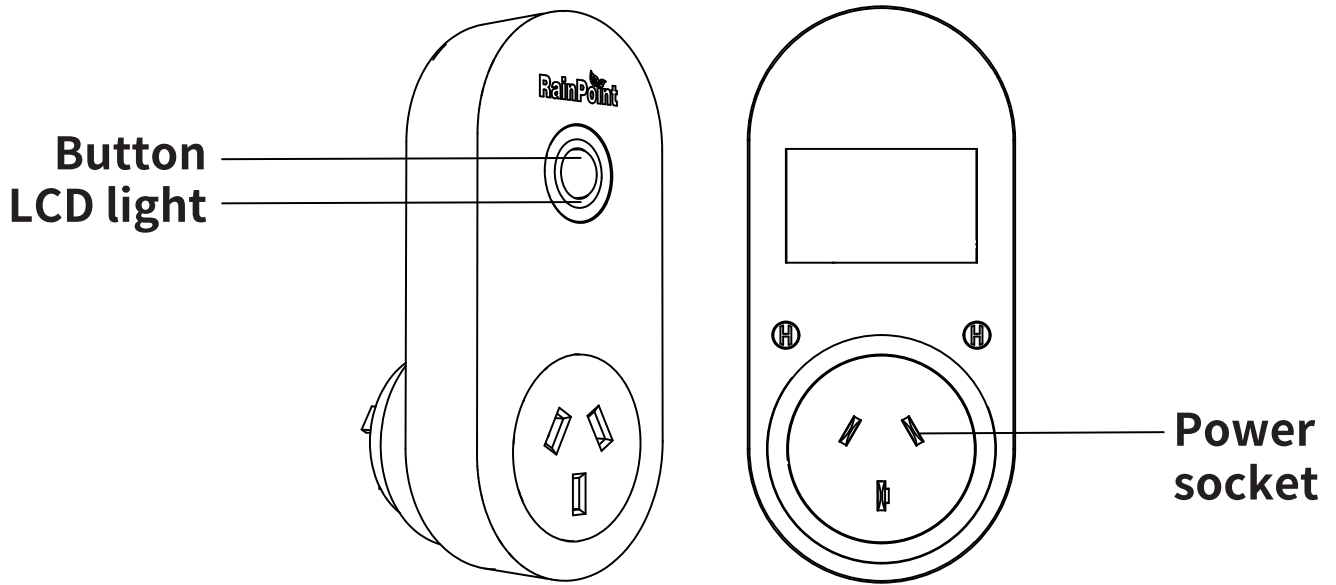

Range: 160 ft in the open area without interference

Temperature Operating Range: 32°F-104°F (0-40°C)

Storage Temperature: -4°F to 140°F (-20 °C to 60 °C)

Humidity Operating Range: 0–90%

WiFi Frequency Band: 2.4Ghz

Input: 100-240V ~ 50/60Hz 0.2A

Output: 5V-1.0A

⚠ WARNING

For Indoor Use Only

3) Rainpoint App Home Screen

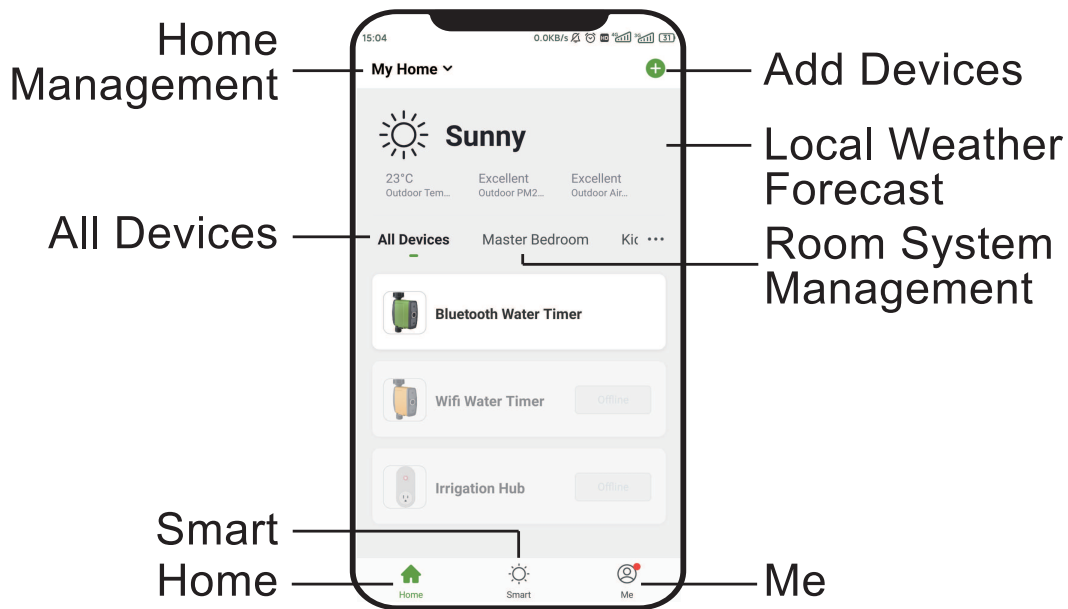

- **Home Management**

Set and add home name and address so you can intelligently manage your home irrigation system.

- **Add Devices**

Rainpoint not only has a smart irrigation system, but also contains a smart socket system. You can enjoy your smart home life by adding Rainpoint smart products.

- **Local Weather Forecast**

Show your local weather forecast from online websites.

- **Room Management**

Room Management is for automatic irrigation systems in different rooms.

- **All Devices**

A check list of all the devices you have connected. Press to enter the operation page of devices you have added to set up your watering program.

- **Smart**

In “Smart” page, there is “Tap-to-Run” and “Automation” functions. You can automate multiple products by setting conditions and tasks.

- **Me**

In this page, there is “Massage Center” and “FAQ & Feedback” functions. You will receive water leak and low battery alerts on “Massage Center” . You can also get FAQ and report issue on “FAQ & Feedback” .

B. Features Overview

- 1) **APP Control:** Connect with 2.4GHz Wifi, set and check irrigation schedule by APP.
- 2) **Manual Watering:** Manually turn ON/OFF and set start time.
- 3) **Watering on Schedule:** 1 timer can set 3 timing watering schedules at the same time.
- 4) **Automatic Watering:** ①When the timer is connected to the soil sensor, it can automatically irrigate or stop according to the soil temperature and humidity data from the sensor; ②It can also synchronize the weather forecast to start or stop watering plans according to the weather data.
- 5) **Rain Delay:** Support Manual or auto rain delay.
- 6) **Water Flow Meter:** Built-in water flow meter tracking water usage in the last 10 days.
- 7) **Two Watering Modes:** Irrigation mode and Mist mode.
- 8) **Co-management with family:** Add family members and give them permissions, manage the irrigation of your garden together.
- 9) **Low Battery and Water Leak Alarm:** Rainpoint APP will send alert messages when low battery or product failure.

Tip 1: One Wi-Fi Hub can control up to 4 water timers at the same time.

Tip 2: Compatible with Rainpoint TCS005FRF Wi-Fi soil sensor.

C. Getting Start

1) Power the Wi-Fi Hub & Timer

① Plug in the Wi-Fi Hub into an indoor outlet.

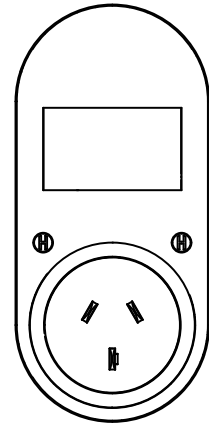
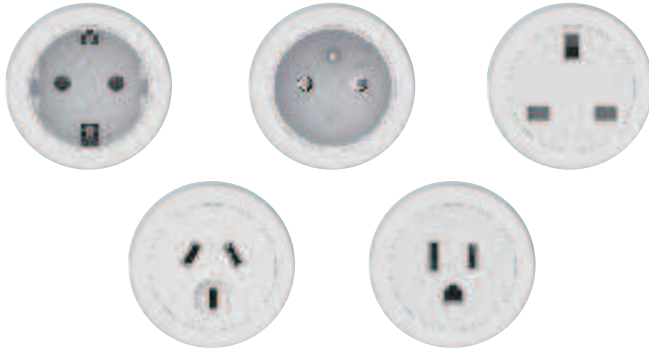

② Insert 4 AA Batteries into the timer
Install the 4 new AA batteries according to the drawings located in the front shell. Then, the front shell cover is firmly locked.

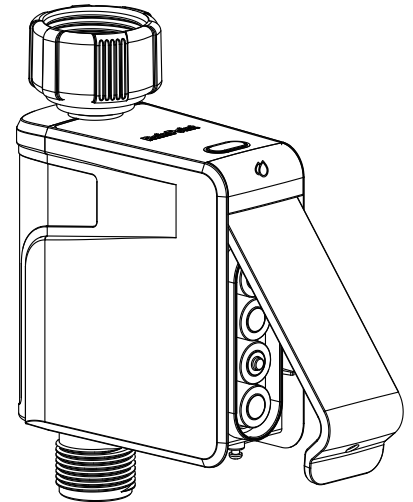

2) Initial RainPoint App Setup

① Download the RainPoint App

Search for “RainPoint” and download Android version or iOS version App for free. Or scan the QR code to download Rainpoint APP



- ② Create an account and login
Create an account or login with an existing account to begin pairing with Wi-Fi Hub and timer .

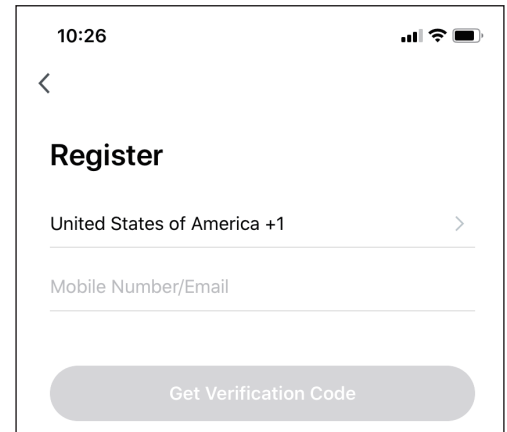

3) Pair the Wi-Fi Hub

- ① Click the button **Add Device** or “+” on the home page of the app.

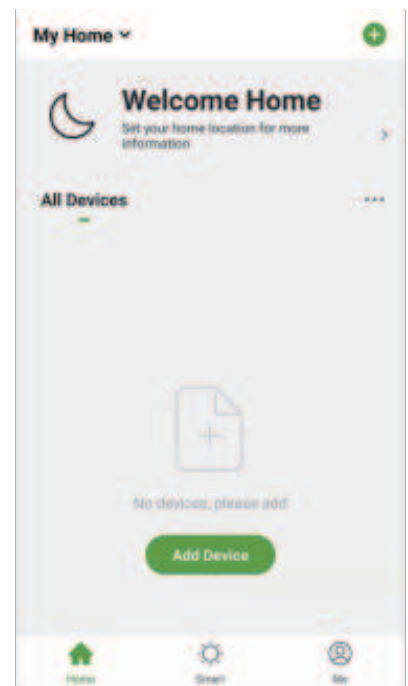

- ② Choose “Add Manually” and “Smart Irrigation” , and then click “Irrigation Hub” .

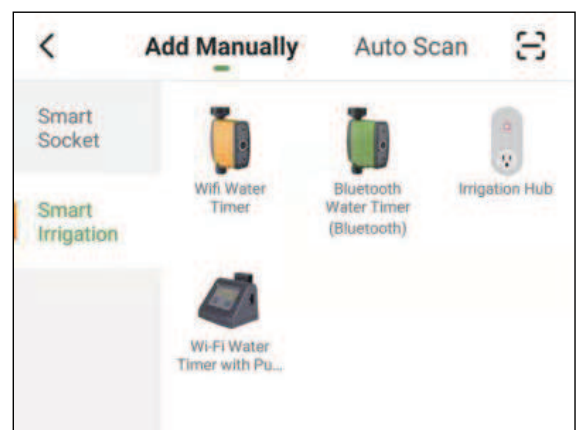

- ③ Follow the app setup wizard. Press and hold the button on the ③ Wi-Fi Hub until the blue LED light rapidly flashing (2 times per second). Then, press to confirm on your app.



- ④ Enter Wi-Fi Password and connect with Wi-Fi. (Only 2.4G Wi-Fi are supported)

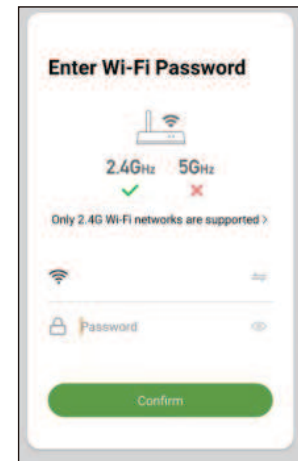

Note:

- ① The blue LED light on the Wi-Fi hub needs to flash quickly, twice per second, otherwise the Wi-Fi connection is unsuccessful.
- ② The Wi-Fi hub only support 2.4GHz Wi-Fi. If your router supports both the 2.4 GHz and 5GHz Wi-Fi, please configure separate Wi-Fi SSIDs for 2.4GHz and 5Ghz, then you can search for 2.4GHz Wi-Fi and connect.
- ③ For more questions about 2.4G and 5G Wi-Fi SSIDs settings, you can find specific answers on the APP: "Me" Page>>FAQ & Feedback.

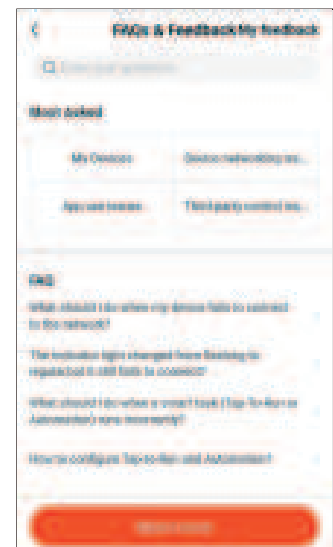

4) Pair the Wi-Fi Hose Faucet Timer

- ① After successfully pairing with Wi-Fi Hub and connecting to Wi-Fi, click the button “Manage added devices” on the app to add your Wi-Fi hose faucet timer.



Or you can click the button **Add Device** or “+” on the home page of the app, then choose “Add Manually” and “Smart Irrigation” to add the Wi-Fi hose faucet timer.



- ② Follow the app setup wizard. Press and hold the button on your timer around 5 seconds until the blue LED light rapidly flash. Then, press to confirm on your app.



- ③ Once the timer is paired successfully, the APP will show “Device added successfully”. And you will see all the paired devices displayed on the APP page.

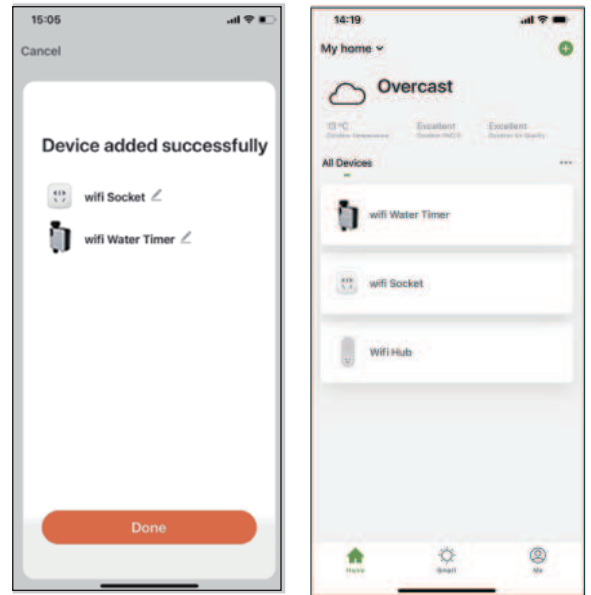

Note:

- ① Please make sure the smart phone is near the Wi-Fi water timer when pairing.
- ② If the timer pairing is not completed within 20 seconds after LED light rapidly flash, the LED light will turn off and the connection will stop. In this situation, please press and hold the button on the timer again until the LED light flashes rapidly to start connection again.
- ③ If the LED light does not flash rapidly when you pair your timer with the App, you might need to reset the device. Please remove and reinstall the batteries on the timer, then press and hold the button for 5 seconds until LED light rapidly flashing.
- ④ If the LED light does not flash rapidly (2 times per second) when you pair your timer with the App, you need to reset the device. Please remove and reinstall the batteries on the timer, then press and hold the button for 5 seconds until LED light rapidly flashing.

5) Install the Timer on the Faucet

Install the timer to an outdoor hose faucet.

Note:

- ① Do not place the timer in an underground valve box or anywhere the Wi-Fi signal will be obstructed.
- ② The working distance between the timer and the WiFi hub can reach to 160 feet in open area without interference. If there are walls, iron gates or bushes between the timer and the hub, please move them closer properly to receive the WiFi signal better.

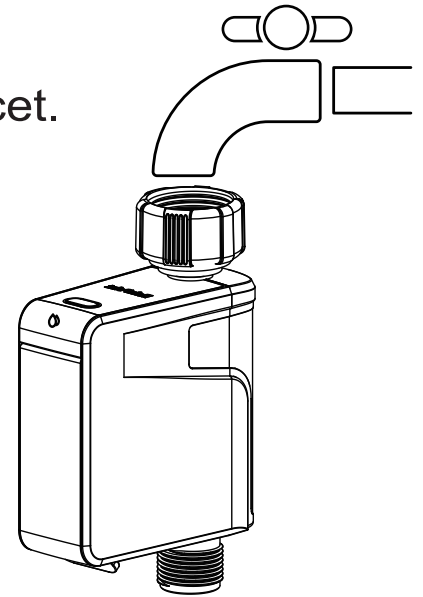

6) Turn on your water

Keep the water faucet on so the timer can work properly.

D. Program Your Timer on APP



After completing the pairing of the timer and hub according to Chapter C [Getting Start] , the Wi-Fi water timer will be displayed on the homepage of your APP. Please click and get into the main page of the device. Programs are able be set on the device' s main page, except Tap-to-Run and Automation program.

Note:

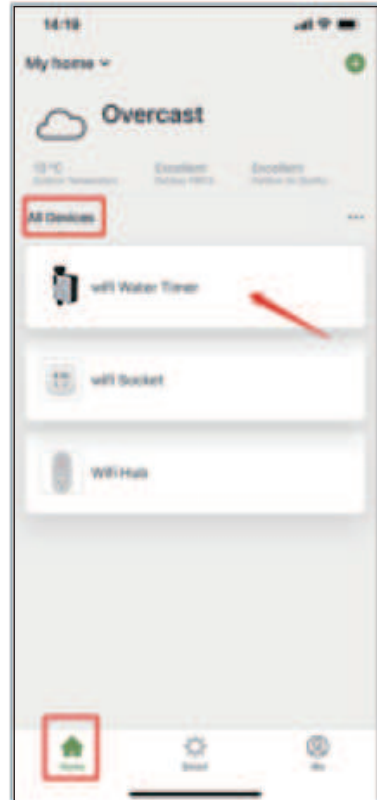
The watering timer will keep running the preset watering plans after setup water schedule successfully, even if the phone is out off the best connecting range or no internet.





1) Pair the Wi-Fi Hose Faucet Timer

- ① On the parameter page  , you will see the following information: °C / °F button  , last water usage, soil moisture and temperature (if soil sensor is connected), battery status, mode and next irrigation time.

Note:

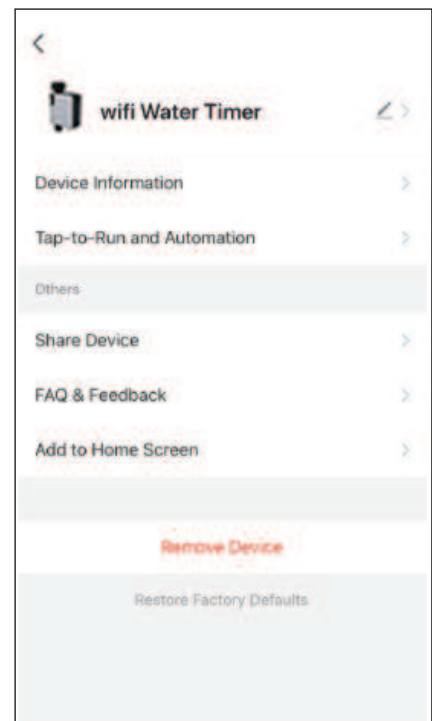
The background color will turn red if the moisture of soil is getting higher than setting level.



- ② Press the pen selection  on the top right corner of the parameter page. There are basic information like Device Information, Tap-to-Run and Automation and other basic functions and services for the device.

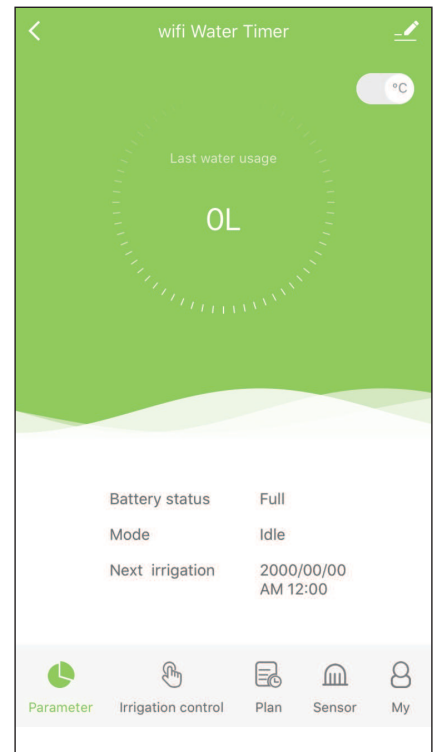

• **Device Information**

On this page, you will get the virtual ID and MAC address of your device.



Note:

If the app and the user manual do not have what you’ re looking for or you need some help, please contact us and leave us the virtual ID of your device contact us before returning the Rainpoint to the store.

1-833-3815659 | service@rainpointus.com

Timer virtual ID:xxxxxxxxxxxxxxxx (Copyable on APP)

• **Tap-to-Run and Automation**

On this page, only the information of Tap-to-Run and Automation that has been set for the device is displayed.

For related setting operations, please refer to Section 4 [Intelligent Automatic Watering] of Chapter D.

- **Share Device**

If one of your home members has already set up an account on Rainpoint APP, we recommend to set the account as a home member and share all home devices with family members, then you can co-manage the home irrigation system with your family.

For more related information, please refer to Section 6 [Co-management with Family] of Chapter D.

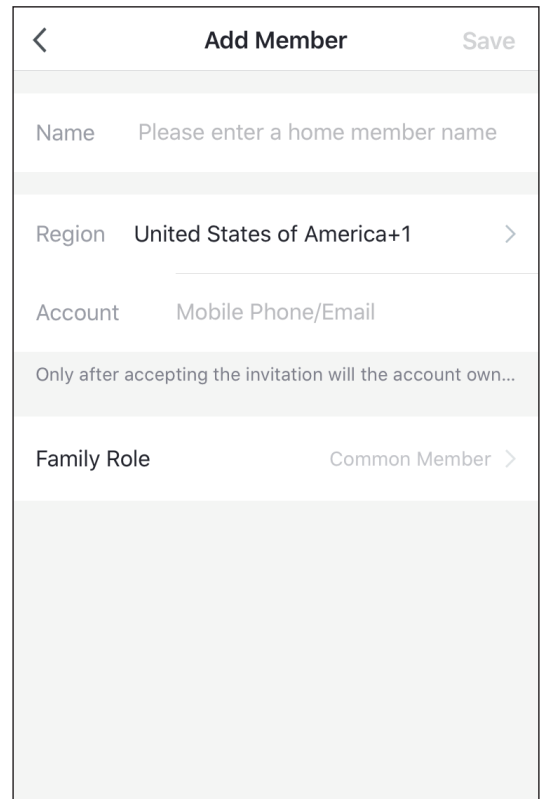

- **FAQ & Feedback**

There are some existing Q&A of the device to solve problems and you can report issues on the APP. However, in order to solve your problem faster, we suggest you contact us directly by phone or email.

1-833-3815659
service@rainpointus.com

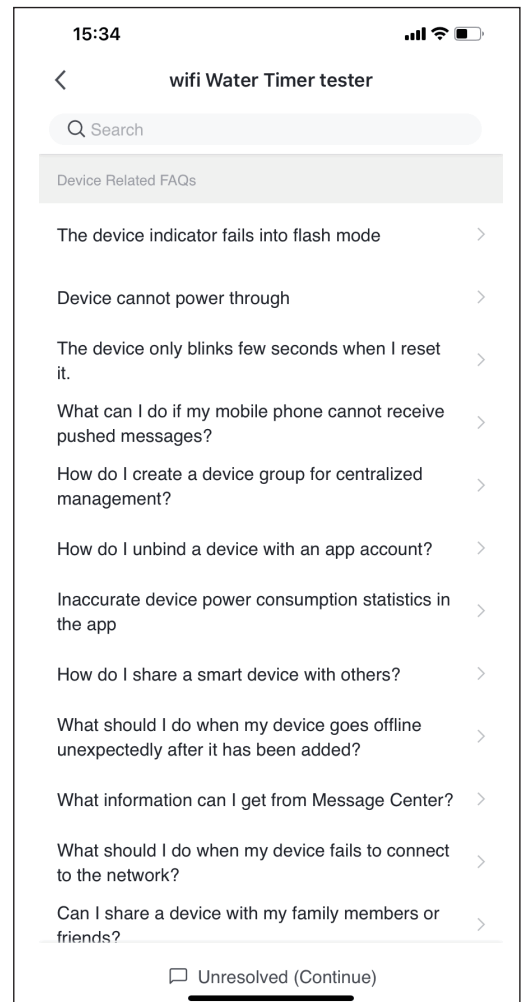

2) Manual Watering

Manual Mode is on “Irrigation control” page.

Click the button “” to turn ON/OFF the Wi-Fi hose faucet timer.

Press and hold the button  on the middle dial and drag it clockwise to set the time for manual watering.

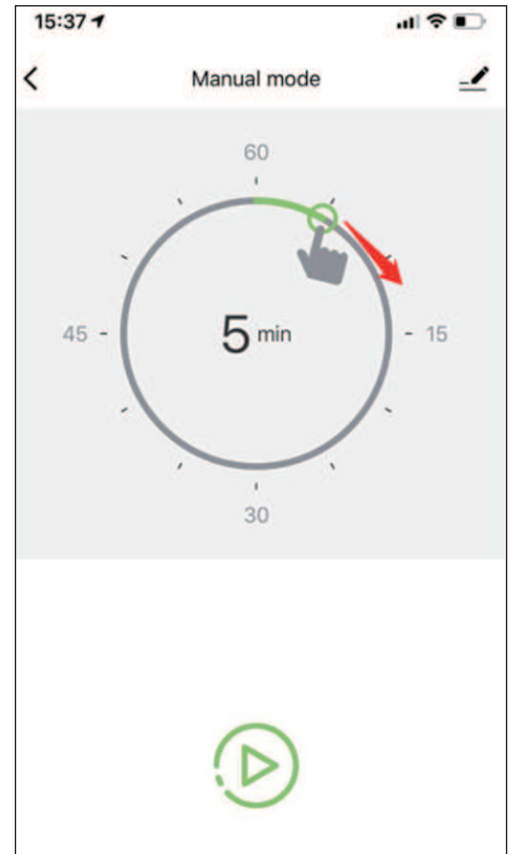

3) Watering on Schedule

Watering Schedule is on “Plan”  page.

• Schedule Overview

On the “Plan” page, there are daily notices of weekdays, plan detail display board and rain delay selections.

There are three plans can be set in total. Each plan has a unique represent color, which will be marked under the weekday from Monday to Sunday as a dot after turned on.

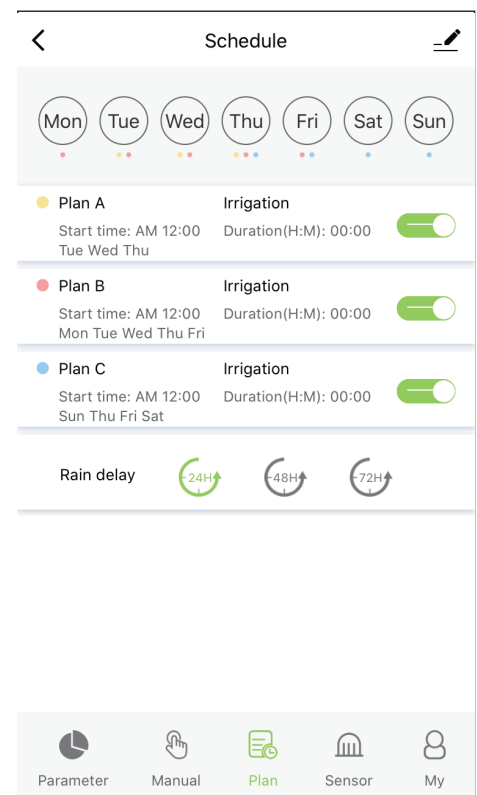
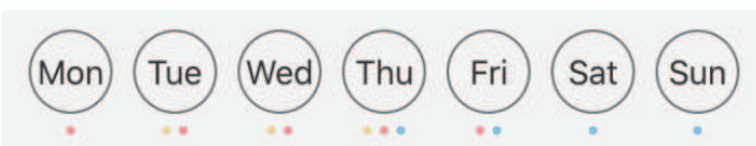

The setting detail of each watering plan is shown below and there are ON/OFF buttons on the right side of each plan.

The rain delay (Watering Delay) can set for 24H, 48H and 72H.

Note:

The rain delay here is a manually set mode. For automatic rain delay and more details, please refer to Section 5 [Rain Delay (Watering Delay)] of Chapter D.

• **Plan Settings**

Press the plan A/B/C to set daily watering schedule. The watering schedule includes two modes: Irrigation Mode and Mist Mode. Different modes have different setting options and both of them can be set with 12-hour or 24-hour type.

Irrigation Mode: 24H time, Start time, Duration, Repeat

Mist Mode: 24H time, Start time, Misting Period, Mist time, Interval, Repeat
Below are two example settings.

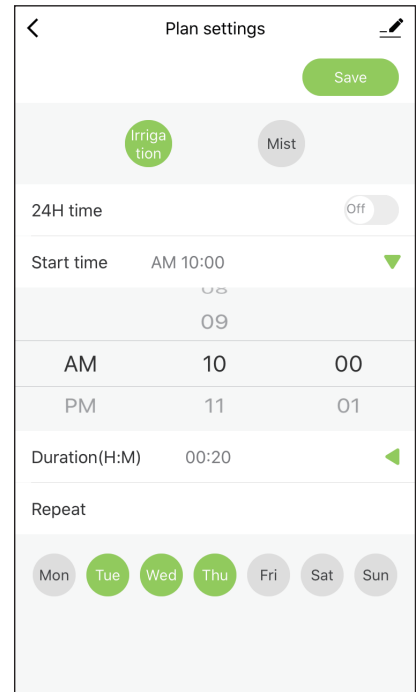

Example ①:

The figure shows that the timer will water for 20 minutes in irrigation mode. The start time is every Tuesday, Wednesday and Thursday at 10 am.

Example ②:

The figure shows that the timer will spray 30 seconds for every 5 minutes during the mist duration, and the duration time is 4 hours which starts from 10:00 am and stops at 3:00 pm on every Monday, Tuesday, Wednesday, Thursday and Friday.

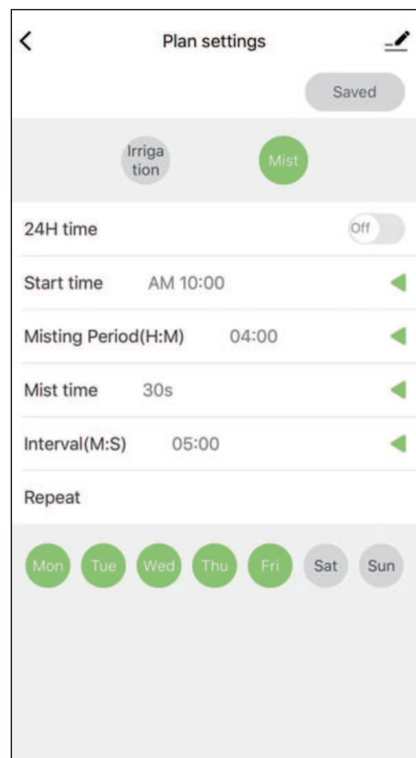

4) Intelligent Automatic Watering

- **Sensor Control**

The data of the Sensor will show on “Sensor”  page.

****The product set does not contain a sensor, please contact the store if necessary.****

If you have a Rainpoint WiFi soil sensor, you can pair it with your Rainpoint Wi-Fi hose faucet timer and Wi-Fi hub. The soil temperature and humidity data monitored by the soil sensor will be displayed on Rainpoint APP.

The soil sensor can stop the timer running the watering plans automatically according to the data. When the soil moisture is too high, the timer will automatically stop watering after setting the stop watering moisture level.

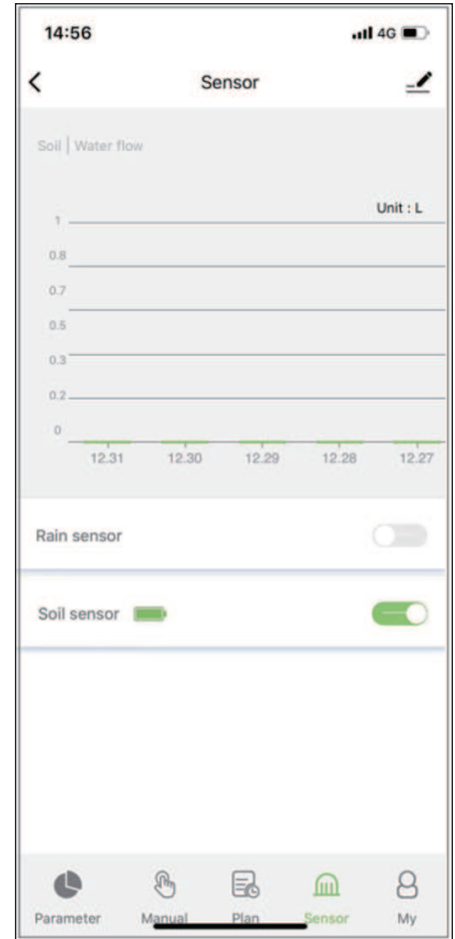

- **Water Flow Meter**

Water Flow Meter is on "Sensor"  page.

The Water flow meter is built in the Wi-Fi hose faucet timer.

Select the option "Water flow"  above the graph, you can check the daily water consumption and last water usage. (The minimum monitoring water flow is 25L/H).

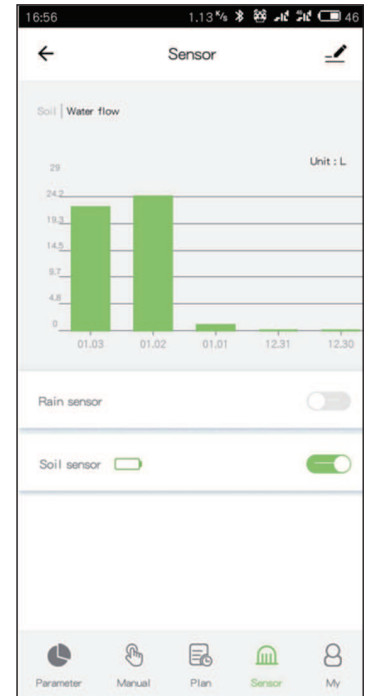

- **Tap-to-Run & Automation**

The functions of Tap-to-Run and Automation are on "Smart" page (not in the device page).

Please go back to the homepage of the APP, the "Smart" page selection is displayed at the bottom of the homepage.

Tap-to-Run is meaning that you can run your multiple devices and plans with one tap.

Automation means the device can execute automatically according to the set conditions such as the local weather, device status and time.

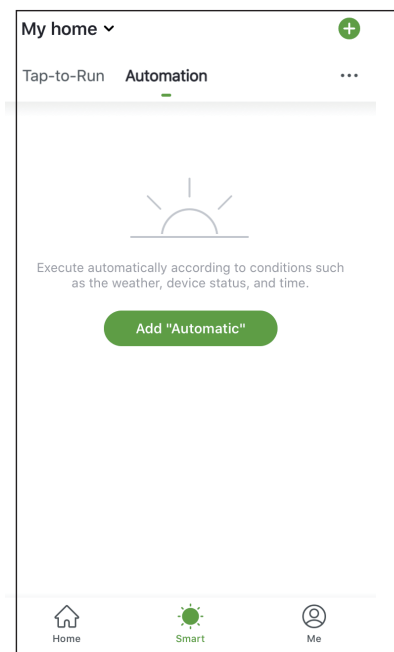
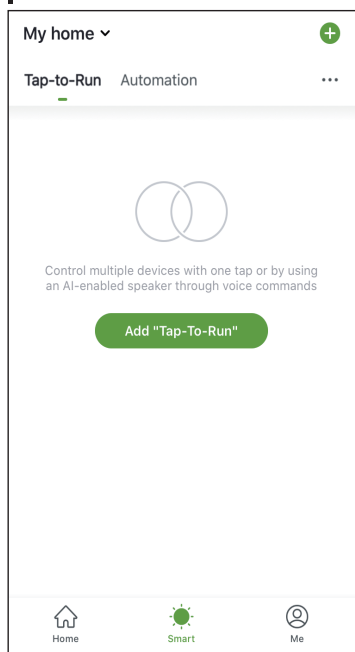

- ① Click the “+” button at the top right corner to create a smart plan. There are some options to set up such as Condition, Task and other personal options.

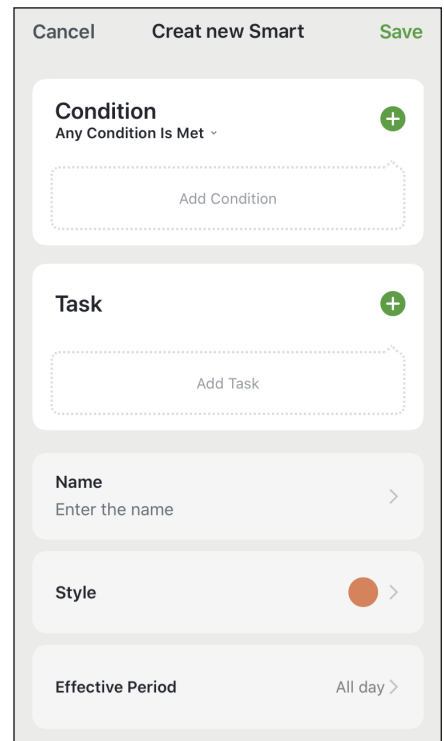

- ② **Condition:** There are many options to choose and a variety of them can be added at the same time.

In the device condition, the basic options of the connecting devices are related to the data from the WiFi timer and sensors.

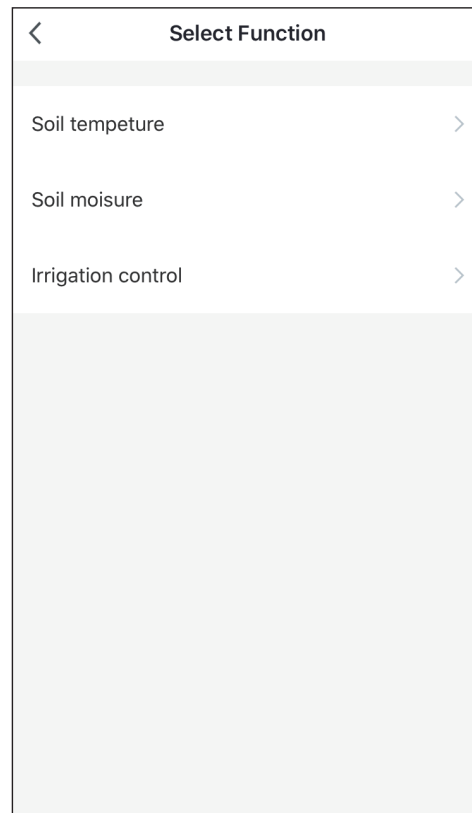
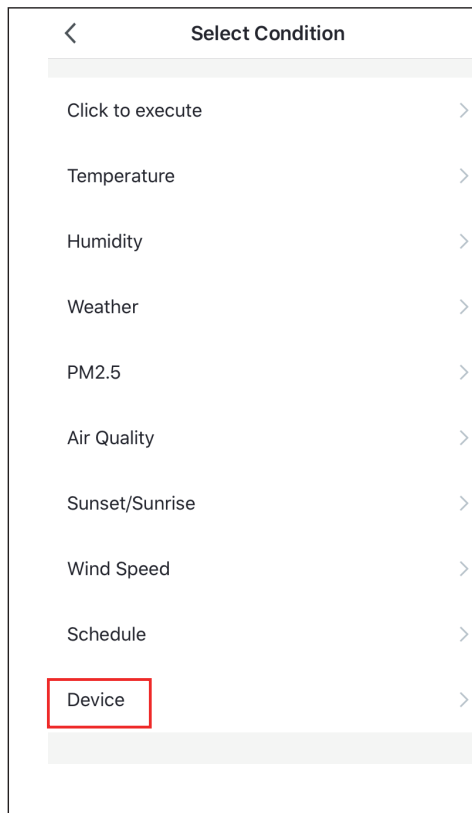

Note:

The plan will be triggered when any single condition is met or all conditions are met at the same time. All the data of current conditions is automatically searched online by the App.

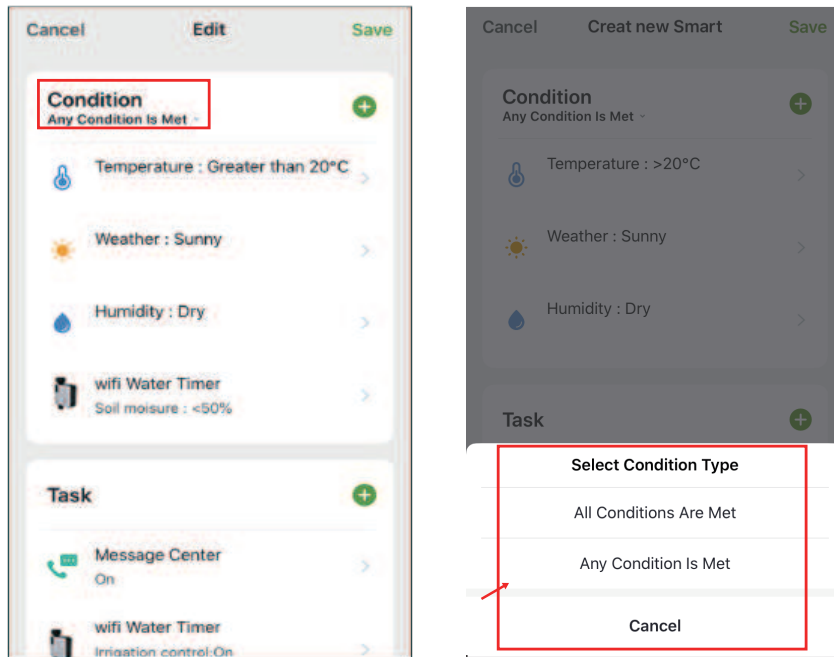

- ③ **Task:** There are different tasks could be set: Tap to Run, Enable or Disable Automation, Send Notification, Delay and Device Option.

When the conditions are triggered, the tasks will be executed.

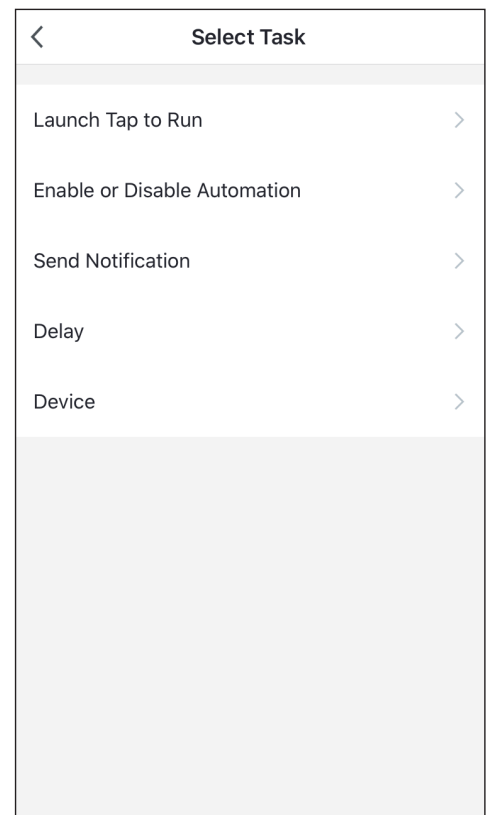

- ④ After finishing setting, the plans will be found under Tap-to-Run and Automation. The button on the right can enable or disable the plan.

The Tap-to-Run function connects different plans and devices at the same time to enable “One-Click Management” .

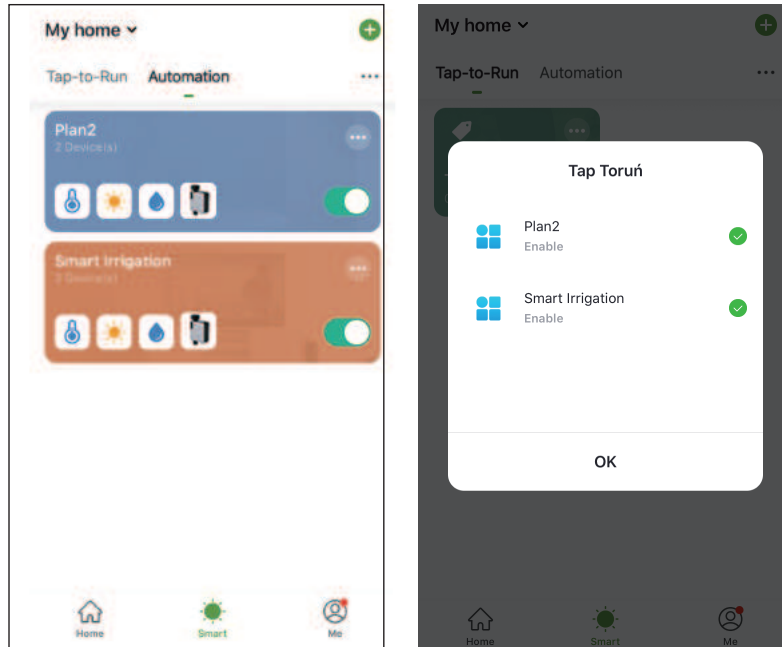

5) Rain Delay (Watering Delay)

• Tap-to-Run & Automation

The route to set the manual rain delay is: Wifi water timer on All devices homepage >> “Plan” page

Rain delay applies to rainy days or other weather that causes high soil moisture. The rain delay means to stop watering from the time of setting and continue watering after a certain period of time. It can be set to delay 24H, 48H and 72H.

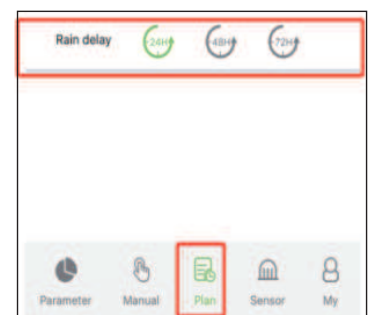
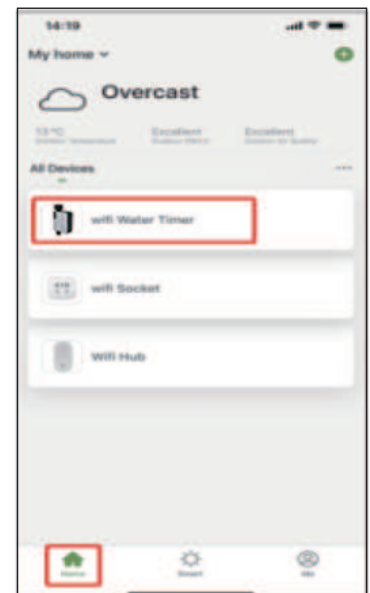

- **Automatic Rain Delay**

Automatic Rain Delay can be set on [Tap-to-Run & Automation]. Automatic Rain Delay means the water timer can execute watering delay automatically according to the set conditions such as the rainy day of local weather.

If you have confirmed an accurate location for your home on the APP homepage, the system will automatically synchronize the local weather information. Then the timer will execute automatically according to the weather information and the conditions you set.

- ① The route to enter the automatic rain delay setting is: “Smart”  at the bottom of the homepage >> Tap-to-Run & Automation >> Automation.

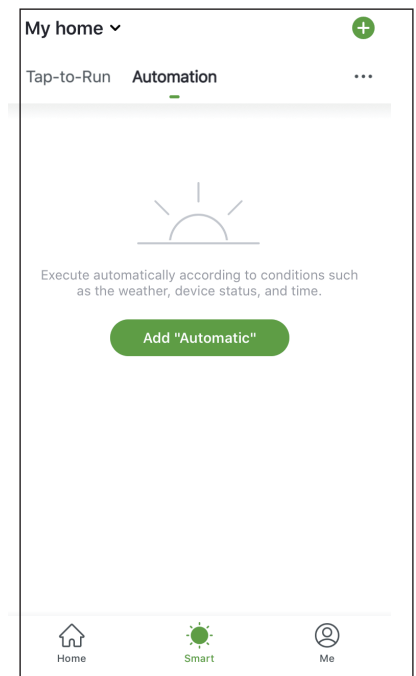

- ② Click the “+” button on the top right corner and create a smart plan. There are some options to set up: Condition, Task and other personal options.

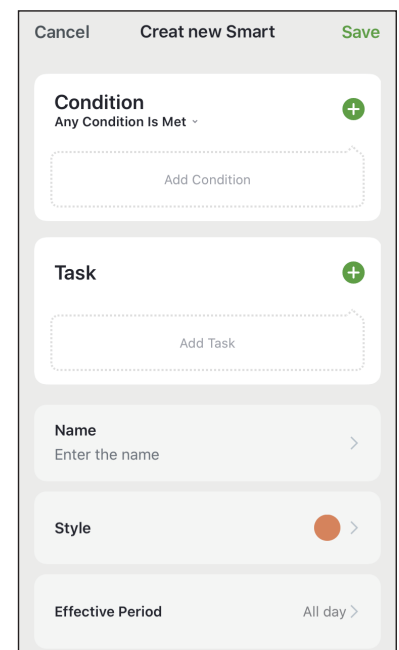

③ Condition

For rain delay, it needs 2 conditions: the weather is rainy and the timer is ON. And these 2 conditions need to be met at the same time.

First, add weather as the first condition. You need to select your current city, then choose rainy.

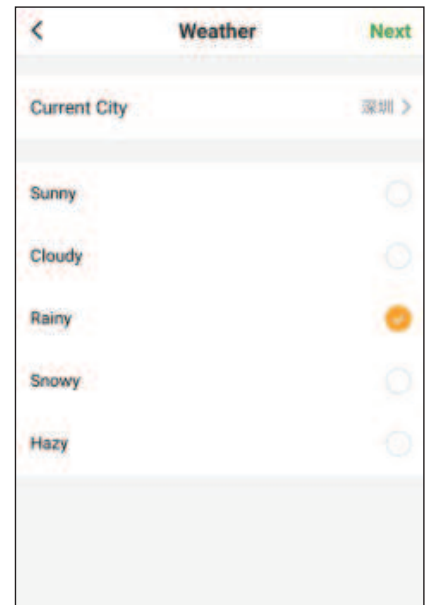

Second, add another condition by clicking the “+” button. Please choose device, then select your wifi water timer. You will see three functions: soil temperature, soil moisture and irrigation control. Please select the irrigation control, then choose ON.

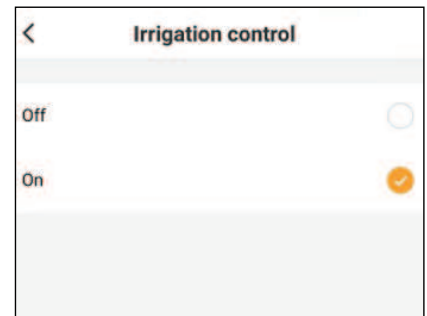

Third, select condition type : All Conditions Are Met.

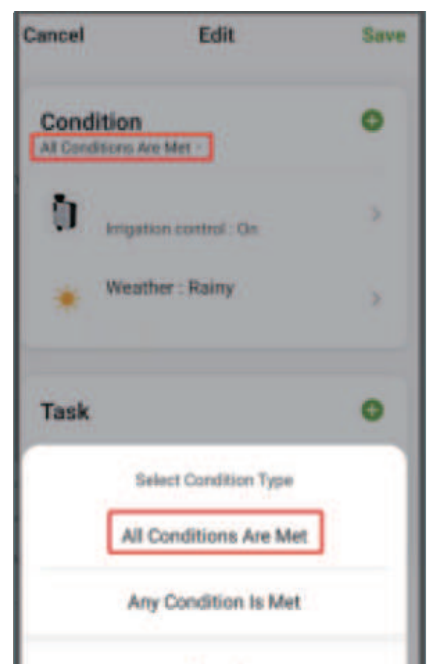

④ Task

Please add device and select your wifi water timer, then choose watering delay. And you can set the delayed watering time to 0h, 12h, 24h and 72h.



Note:

Do not add “Delay” as the task of setting rain delay. The “Delay” in the task refers to delaying the execution of the task, not the timer watering delay.

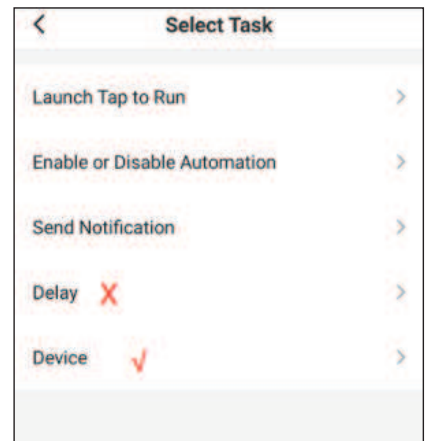

⑤ After finishing setting, the icons of plans will be found under Automation. The button on the right can enable or disable the automation.

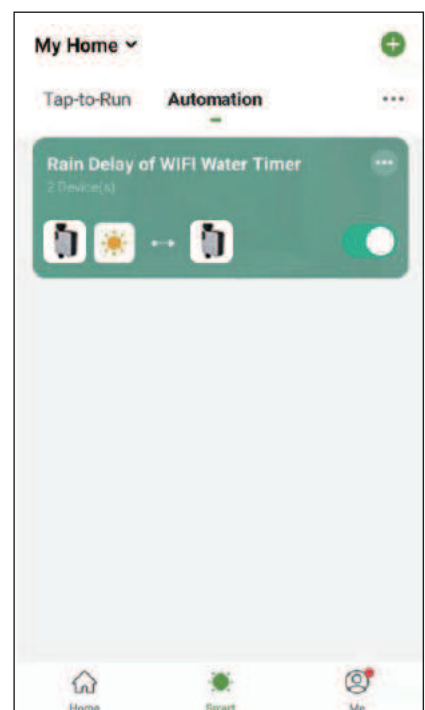

6) Co-management with Family

Rainpoint supports for adding family members and sharing your home device to achieve co-management of home irrigation system with your family.

① Home Management

Click "Home Management" on "Me" Page to edit home name and address. Home address is related to the weather forecast information obtained by the system.

② Share Device

"Share Device" is on the page of the specific device you want to share. First, select the WiFi water timer you want to share on your homepage. Second, click the "+" button in the top right corner on the device page. Then, you will see the option of sharing device.

If your family member already has an Rainpoint APP account, you can directly fill in the blanks to add him/her. If your family member does not have an account, he/she needs to register an account before sharing.

After successfully sharing the device with family members, you can manage the device together.

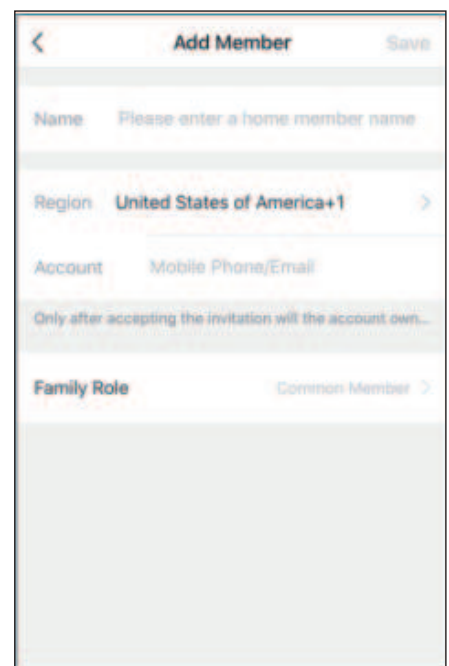
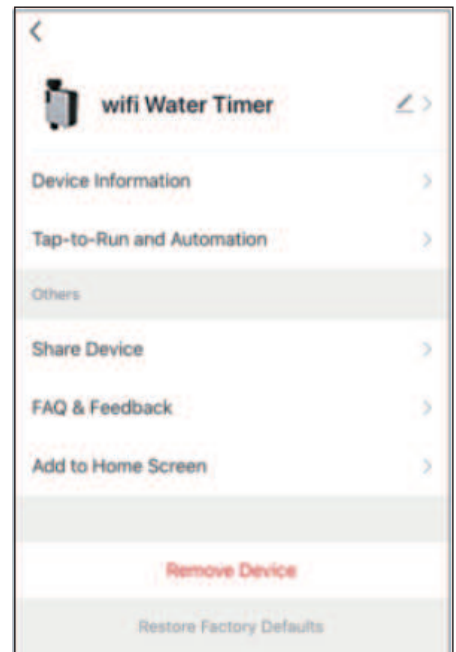

E. Troubleshooting

Problem	Possible Solution
Can' t turn off the valve	Please check if the filter is damaged that impurities enter into the valve body.
Keep showing disconnected after reinstall batteries	It will go back online after 1 minute when power on.
The timer' s battery life is too short	Please make sure using Alkaline batteries, not Carbon zinc batteries.
If your Rainpoint product does not operate properly after trying the troubleshooting steps, please contact us by phone or email : 1-833-3815659 service@rainpointus.com	

1) How to Manually Restore Factory Default Settings?

If you accidentally deletes the connected device from the App and cannot reconnect, we suggest you to manually restore the device to factory default settings and reconnect.

① **Reset the Wi-Fi hub**

Step 1. Hold the button and plug in the Wi-Fi hub at the same time, until the light turn red and then release the button.

Step 2. Press and hold the button again until the light quickly flashed, then the Wi-Fi hub is restored to pairing mode.

② **Reset the Wi-Fi hose faucet timer**

Step1. Take out all the batteries of your timer and hold the control button. At the meanwhile, reload the batteries. Please keep holding the button until LED light turn red.

Step2. Press and hold the top button again, the LED light will quickly flashed, it means the tap timer is restored to pairing mode.

2) The meaning of LED light

- ① White and rapidly blink: Ready for pairing with smart phone;
- ② White and slowly flash: Searching the connecting Wi-Fi hub;
- ③ Red and blink every 6 seconds: Low batteries power warning;
- ④ Red and breathing light blink: Water leaking when turn off the water timer;
- ⑤ Red when searching a sensor: Does not find the sensor.

F. Warning & Warranty

1) Warning

- Under freezing temperatures, timers should be removed from the faucet and stored indoor to avoid potential freezing damage.
- Please clean filters regularly and replace if it is worn in order to prolong life of timer.
- Do not clean any part of the product with benzene, thinner or other solvent chemicals.
- Never immerse the product in water. It will cause electrical shock and damage the product.
- Do not install the product with extreme force and shock.
- Do not tamper with the internal components.
- Do not mix new and old batteries or batteries of different types. Please remove the batteries when store the product for a long period of time.
- Do not dispose of the product as unsorted municipal waste. Collection of such waste separately for special treatment if necessary.

2) Warranty

Rainpoint provides a 1-year limited warranty on this product against manufacturing defects in materials and workmanship.

Warranty service can only be performed by our authorized service center. The original dated bill of sale must be presented upon request as proof of purchase to us, or our authorized service center. The warranty covers all defects in material and workmanship with the following specified exceptions: (1) damage caused by accident, unreasonable use or neglect (including the lack of reasonable and necessary maintenance); (2) damage occurring during shipment (claims must be presented to the carrier); (3) damage to, or deterioration of any accessory or decorative surface; (4) damage resulting from failure to follow instructions contained in your owner's manual. This warranty covers only actual defects within the product itself, and does not cover the cost of installation or removal from a fixed installation, normal set-up or adjustments, claims based on misrepresentation by the seller or performance variations resulting from installation-related circumstances. To receive warranty service, the purchaser must contact with Rainpoint nominated service center for the problem determination and service procedure.

Thank you for choosing Rainpoint products!

G. Get Help

If you find it difficult to set up and want to view the setting tutorial videos, please subscribe our YouTube channel: Rainpoint.

If the app and the user manual don't mention what you're looking for or you need some help, please check the virtual ID of your device and contact us with it.

1-833-3815659 | service@rainpointus.com

Timer virtual ID:xxxxxxxxxxxxxxxx (Copyable on APP)*

*Please refer to section 1 [Parameter of your timer] of Chapter C to get your timer virtual ID.



www.rainpointus.com

Email: service@rainpointus.com

Phone: 1-833-381-5659 (US Office)