

Instruction Manual

WIFI AUTOMATIC WATERING PUMP KIT

Model: IK10PW

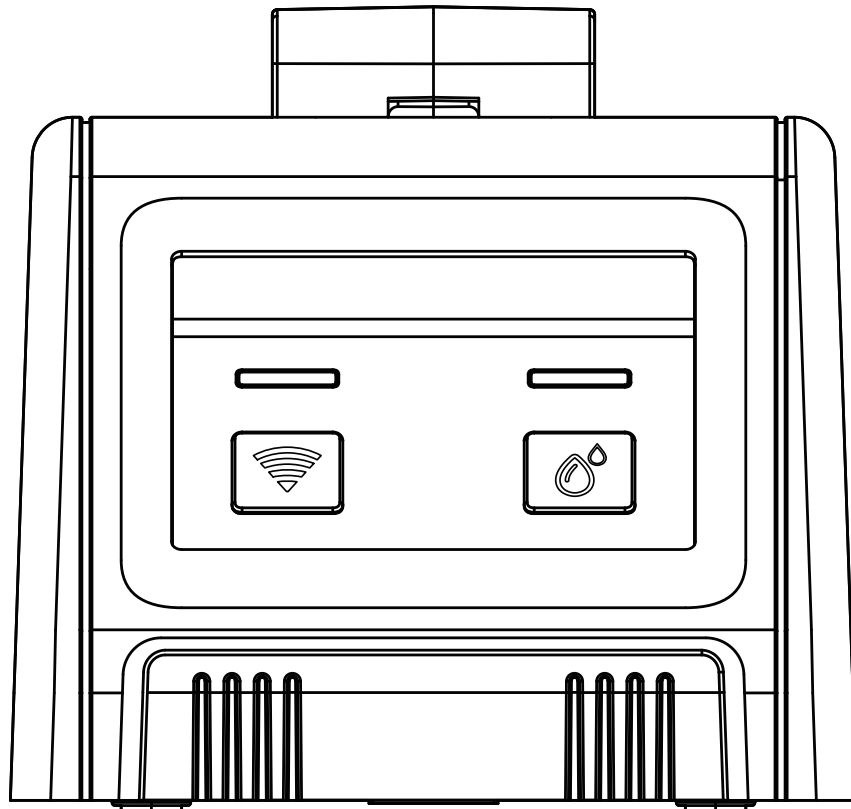

Customer Support

WEB: www.rainpointus.com

Email: service@rainpointus.com

Free Hotline (US): 1 833 3815659

Please contact us at the above for support with any questions about use.

WELCOME TO RAINPOINT -----

The IK10PW is a WiFi automatic watering pump kit, like any other Wi-Fi device: if you have access to the Internet, you can connect to your pump from anywhere, perfect for business trips, travel or any busy person; also works well in indoor, balcony, office, and so on scenarios where there are no water faucets.

As the device requires wifi pairing and simple assembly before first use, it may be challenging. please take 3-5 minutes to read the instructions and operation guide before using it, which will help you use it better.

PLEASE NOTE!!! If you make into trouble during use, please contact us by the following, we will do our best to solve them. (PS. All RainPoint products also have the contact ways for support on the back.)

 www.rainpointus.com

 service@rainpointus.com

 1 833 3815659

TABLE OF CONTENTS -----

PRODUCT OVERVIEW ----- 1-3

- 1. Product Appearance ----- 01
- 2. Package Includes ----- 02
- 3. Specification ----- 03

EASY TO INSTALL ----- 4-8

- 1. 2 Ways to apply power for activating the pump ----- 04
- 2. Determine the correct placement ----- 06
- 3. Connect the hose correctly ----- 07
- 4. Installation completed and tested ----- 08

SIMPLE TO PAIRE WIFI ----- 9-11

- 1. Initial RainPoint App Setup ----- 09
- 2. Pair the water pump ----- 09

APP INTERFACE OVERVIEW ----- 12-15

- 1. Home Interface ----- 12
- 2. Irrigation Schedule Settings ----- 12
- 3. Device Information ----- 13
- 4. Smart Function Interface ----- 14
- 5. Personal Date Interface ----- 16

AUTOMATIC WATERING MODE ----- 16

MANUAL WATERING MODE ----- 17

REST THE DEVICE ----- 17

TROUBLESHOOTING ----- 18

WARRANTY----- 20

CUSTOMER SUPPORT----- 20

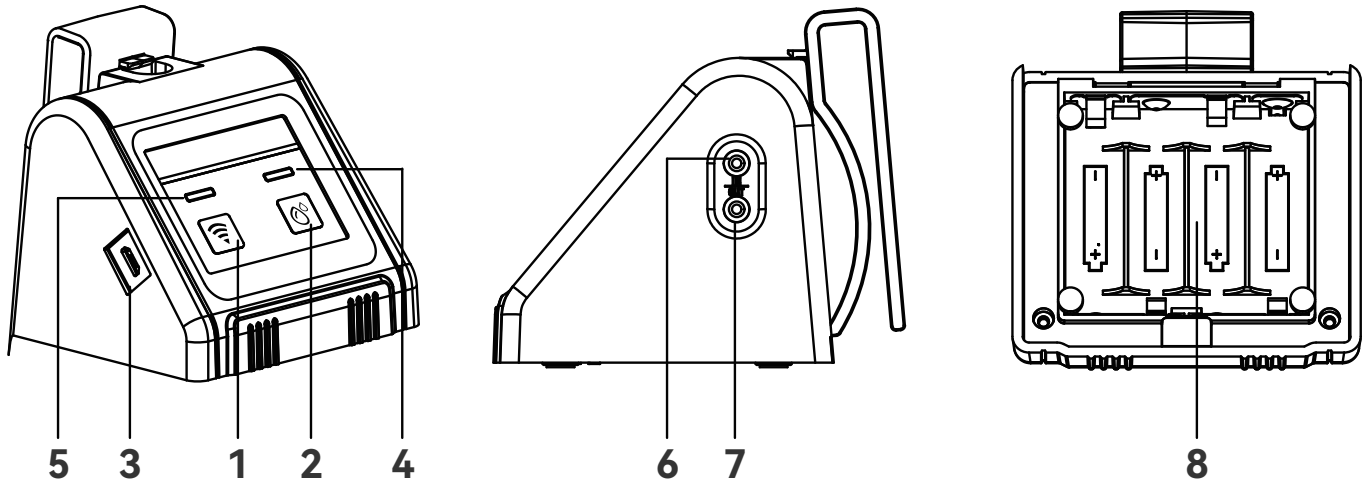

PRODUCT OVERVIEW

1. Product Appearance



No.	Name	Function
1	WiFi Button	Pair WiFi or reset
2	Manual Button	Manual or pause watering
3	USB Port	Manual or pause watering
4	Pair WiFi or power supply	Indicates the status of WiFi disconnected, connected or completed
5	Watering Indicator Light	Indicates the status of WiFi disconnected, connected or completed
6	Inlet Port	Water conveying to the pump
7	Outlet Port	Water conveying to plants
8	Battery Compartment	Power supply

2. Package Includes

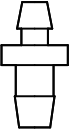
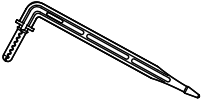
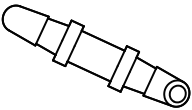
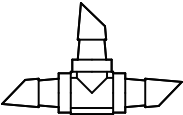
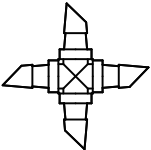
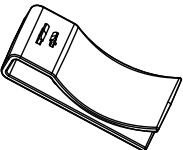
Accessories Included	Name	PCS	Function
	USB Cable	1	*Pair WiFi or power supply
	Tubing	1	LEN: 10m/32.8Ft Inner diameter of pipe:0.17” (> 1/6”) Outside diameter of pipe: 1/4”
	Filter	1	*Filtering impurities from water
	Tubing End Caps	3	*Stop water flow at the end of the pipe
	Micro Drip Emitters	10	*Inserted into the soil to water the plant root directly
	Straight Barb Fitting	3	*Connecting water pipes
	T Barb Fitting	10	*Split water and connect pipes
	Cross Barb Fitting	3	*Split water and connect pipes
	Detachable Hook	1	Put it on the timer to make the timer hangable

3. Specification

Working Pressure	0.3Bar
Water Flow	30L/H
Water Proof	IPX2
Pumping Head	2-3m
Pumping Distance	2-3m
Maximum Water Pressure	≥200kPa
Working Temperature	0°C to 50°C(37°F-122°F)
Power By	USB cable (included) or 4*AA batteries (excluded)
Material	ABS

EASY TO INSTALL

1. 2 Ways to apply power for activating the pump

1.1 Insert 4*AA 1.5V alkaline batteries

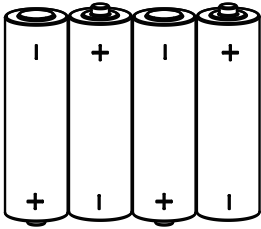
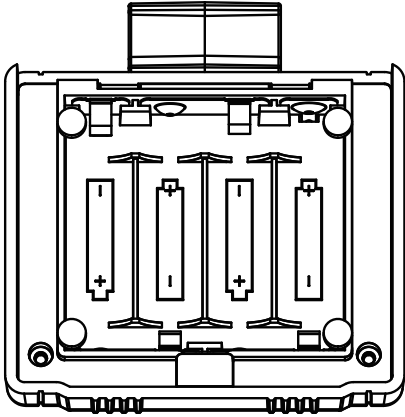

- 1) Remove the battery tray back of the pump.
- 2) Inset 4 brand new AA (1.5V) alkaline batteries (not included) as the marked "-", "+" direction.
- 3) Firmly reinstall the battery cover back into the pupm.
- 4) Once the battery is powered on, the indicator will light up when you press  button.

⚠ Note:

- Firmly restore the battery cover to ensure water resistance.
- When it is idle, please remove the battery and store it properly.
- Used up or dead batteries must be removed from the timer.
- Do not dispose of batteries in the fire,which it may explode or leak.

EASY TO INSTALL

1. 2 Ways to apply power for activating the pump

1.2 Plug in the cable of the UBS port

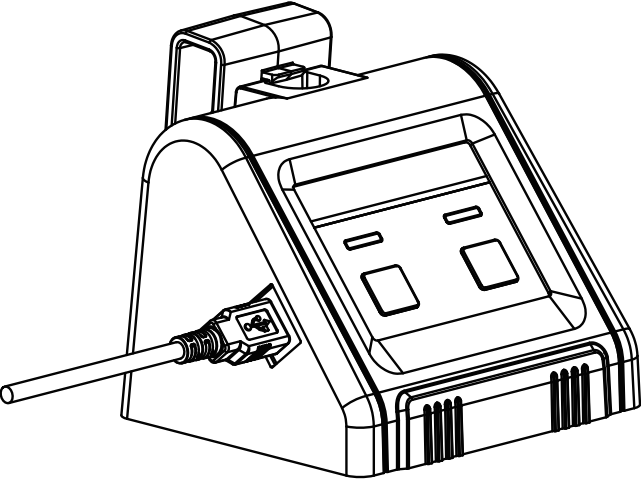

- 1) Plug in the USB cable (included)
- 2) When the power is on, the  indicator will light up.

Note:

- High current support is required for pairing WiFi and accessing APP, so it is only available in USB cable-powered mode.
- WiFi pairing and APP access are not available in battery-powered mode only.
- Only manual watering is supported in battery-powered mode.
- When both power modes are used simultaneously, it will match the USB cable power first; when the USB cable is disconnected, the battery-powered mode is activated.

2. Determine the correct placement

2.1 Please put the pump below the water level of the reservoir to effectively avoid the siphoning phenomenon. (The siphoning effect will cause the water leaking and over-watering problem)



2.2 The lift length of the water pump: the vertical distance of 2-3m, because the water pipe can not be placed 100% straight, we recommend that the height of the plants than the pump should not exceed 2.5m.

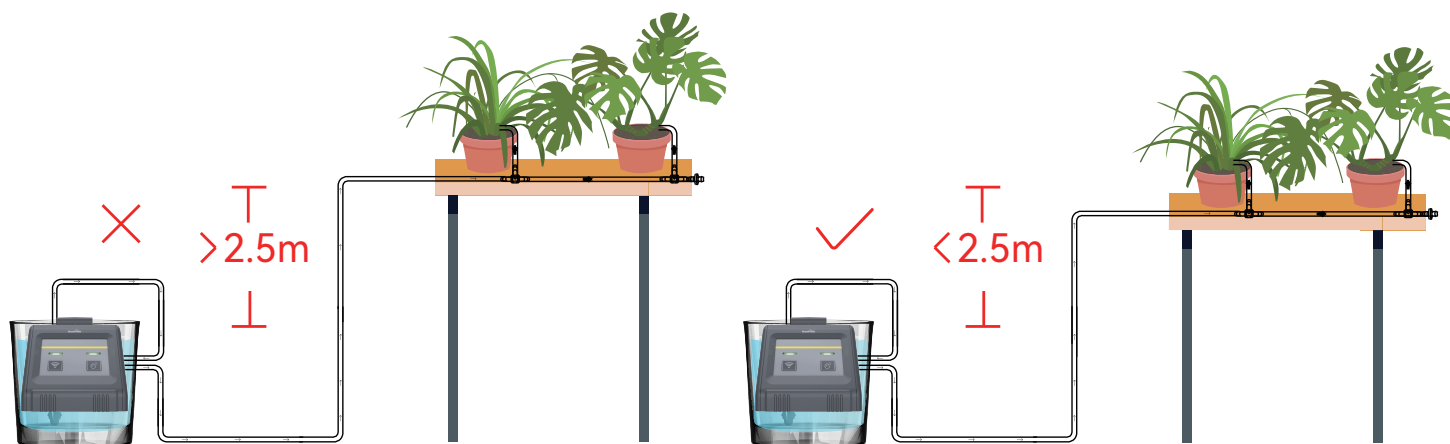

3. Connect the hose correctly

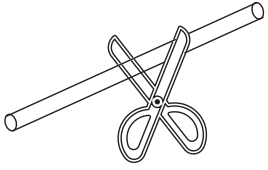

3.1 Cut the hose according to the distance of the device, the plant or you need

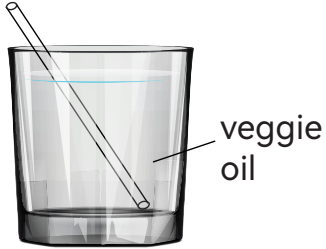

3.2 Put the head of hose into hot water for 10s or Put a little veggie oil on the end of the hose before connecting

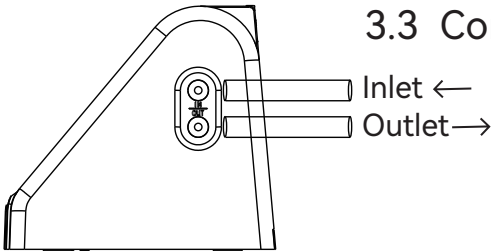

3.3 Connect the hose to water inlet and outlet

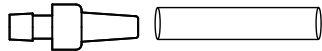

3.4 Insert the other end of the hose connected to the water inlet of the pump into the filter, and then put it into the container.

3.5 Connecting the suitable barb fitting



1) If only the hose needs to be connected, you can use straight barb fitting

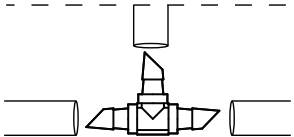

2) When you need to connect the hose while splitting a hose, you can use the "T" barb fitting

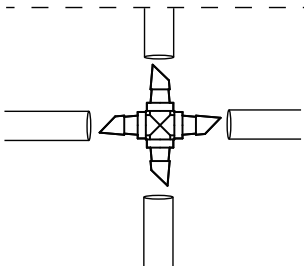

3) When you need to connect a hose while splitting 2 hoses, you can use the cross barb fitting

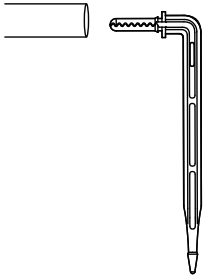

3.6 When water needs to be delivered to the soil, you need to use the micro drip emitter

Tips:

Loosen the soil first, then insert the drips at least 3 inches deep, which will help water enter the plant roots.



3.7 Connect a tubing end cap when you finished a branch installation

4. Installation completed and tested

- 4.1 Press the  button to activate the pump, then the water will be pumped to your plants.
- 4.2 Check if there is any leakage in the connection part of the hose. If so, it means no tightening, please keep tightening until there is no water leakage.
- 4.3 After testing with no usage problems, go to the next step: WiFi pairing and programming plans.

SIMPLE TO PAIR WIFI

1. Initial RainPoint App Setup



Rainpoint



1.1 Search for "RainPoint" and download Android version or iOS version App for free. Or scan the QR code to download Rainpoint APP.

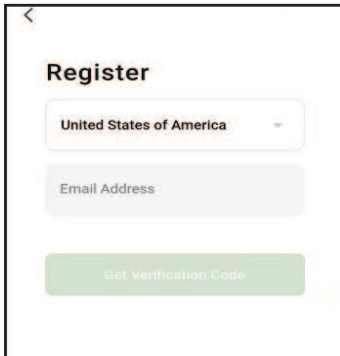

1.2 Create an account and login Create an account or login with an existing account to begin pairing with Wi-Fi water pump.

2. Pair the water pump

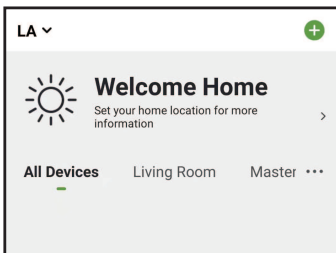

2.1 Click the button or on the home page of the APP.

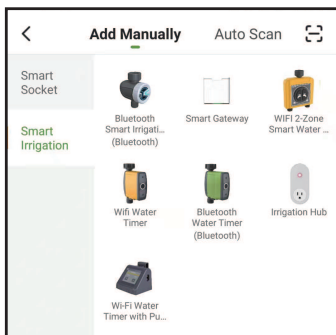

2.2 Choose "Add Manually" and "Smart rrigation", and then click "Wi-Fi Water "

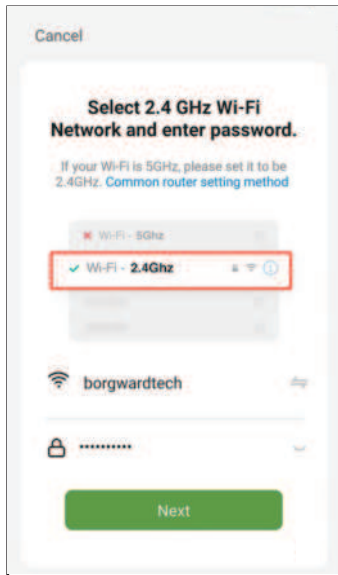

2.3 Select 2.4GHz Wi-Fi Network and enter password.
Then click "Next".

Note :

RainPoint Wi-Fi water pump only pairing with a 2.4GHz WiFi, for a dual-band router, please independently enable 2.4GHz WiFi band and name it differently from 5GHz WiFi band. Please click and follow the "Common Router Setup Methods" to separate them.

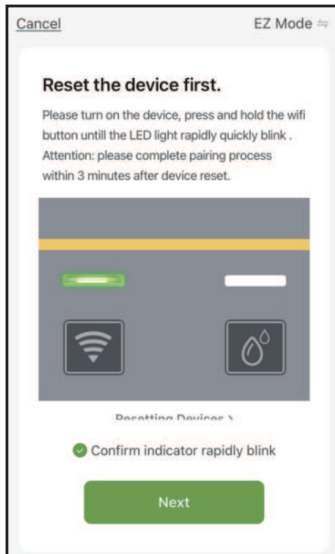

2.4 Powered the pump with USB cable and follow the instructions on the APP to reset first. Then click "  " to confirm indicator rapidly blink and click "Next" to enter the pair mode.

Note :

- Pairing WiFi and accessing APP requires high current support, so make sure the USB cable is powered on before pairing.
- Press and hold  button until the indicator light blinks quickly.

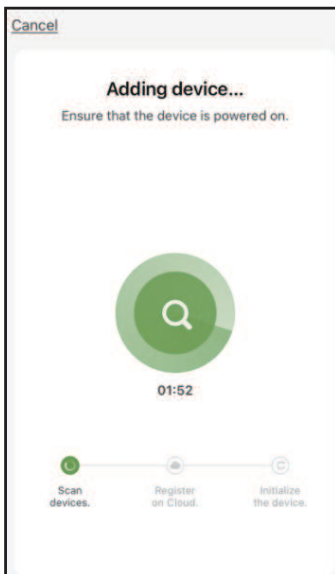

2.5 Wi-Fi pairing requires about 1-2 mins, once the device is paired successfully, the APP will show "Device added successfully".

Note :

- You can customize the name of the device as required.
- If you have not been able to pair for over 2 mins, please go to page 9 and follow the instructions to fully reset the device and start pairing again from the beginning.

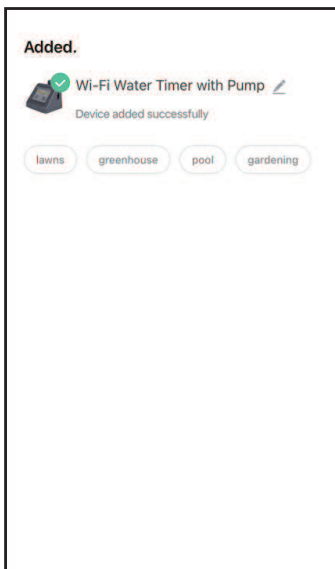

FCC Notice:

FCC ID: 2AWDBTTP106W

This device generates radio frequency energy and may cause interference to radio and television reception. It has been type tested and found to comply with the limits for a Class B computing device in accordance with the specifications in Part 15 of FCC Rules, which are designed to provide reasonable protection against such interference in a residential installation. However, there is no guarantee that interference will not occur in a particular installation. If this

equipment does cause interference to radio or television reception, which can be determined by turning the equipment off and on, the user is encouraged to try to correct the interference by one or more of the following measures:

- Reorient the receiving antenna
- Move the device away from the receiver
- Plug the device into a different outlet so that device and receiver are on different branch circuits.

If necessary, the user should consult the dealer or an experienced radio/television technician for additional suggestions.

APP INTERFACE OVERVIEW I

1. Home Interface

Weather Forecast

Get the weather data for the town you selected to realize intelligent watering.

Added device(s)

Click on your selected device to next step and start your irrigation schedule settings.

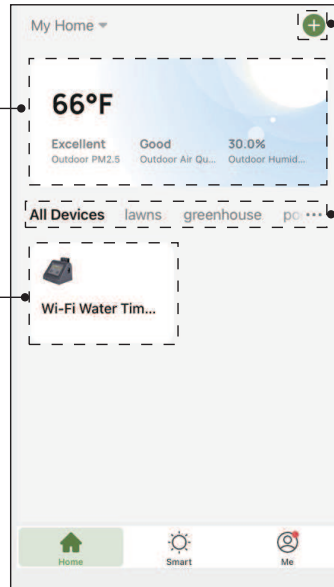

Add Device

Allows to add multiple RainPoint smart devices.

Created Home

Customize home names of the different irrigation areas by entering "My Home".

2. Irrigation Schedule Settings

Next Irrigation

Countdown for the next irrigation

Automatic Watering Mode

Watering Frequency:
1 hr to 7 days
Watering Duration:
6s to 30 mins

Auto Run

Click to start running the schedule you setup.

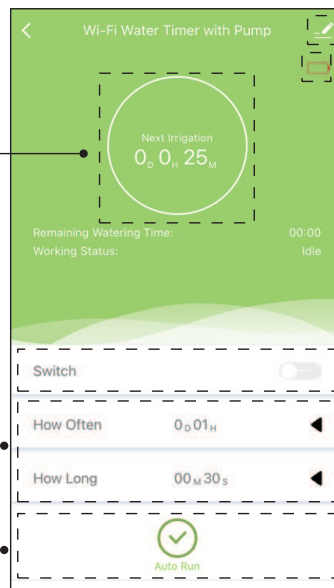

Device Information

According to your needs to set, please refer to Page .

Battery Status

For different battery status, refer to Page to view.

Manual Watering Switch

Turn ON/OFF manual irrigation as needed, refer to Page to view setting tips.

3. Device Information

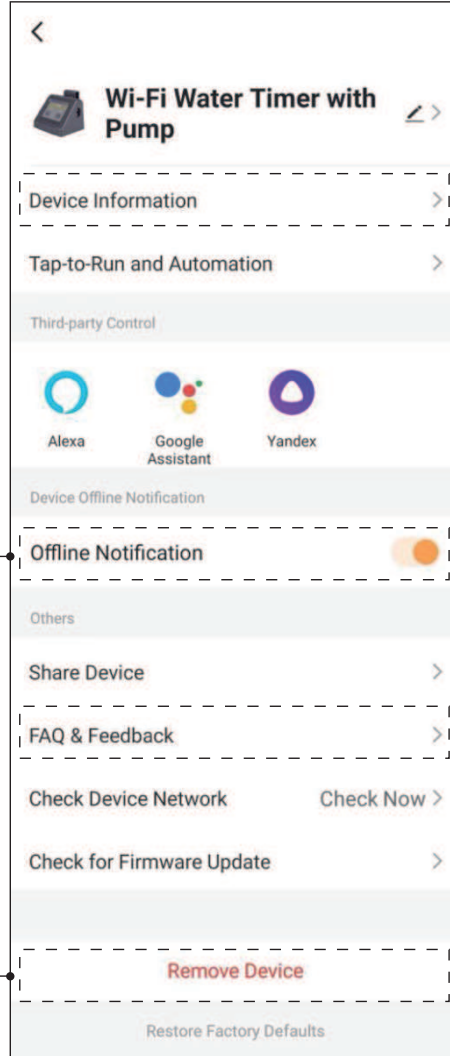

Virtual ID For Device



Offline Notification

Open: send a message to APP when device is offline.

Remove Device

Remove the device before resetting it, refer to Page to view.

FAQ & Feedback

Asking support and feedback questions.

4. Smart Function Interface

Automation Function
Customize multi-irrigation plans with local weather, temps, humidity, sunrise/sunset or weeks.

Tap-to-Run Function
Means you can set and control multiple devices and plans with one tap.

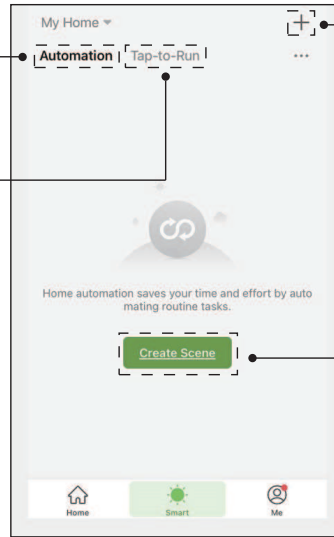

Add Watering Plan
Click to set the conditions and tasks for your plan.

Notice:

1. "Automation" and "Tap-to-Run" are different on function and setting. "Automation" is mainly for the new smart plan setup, while "Tap-to-Run" is mainly for easy control on the smart plans.
2. Make sure your device is always connecting and staying online to run Automation as normal. Please keep the USB cable charging the device to keep the timer connecting online.
3. The "notice" function in Automation is ON only if you set it up in task.

4.1 Condition Settings

Setup arguments and add conditions as your required.

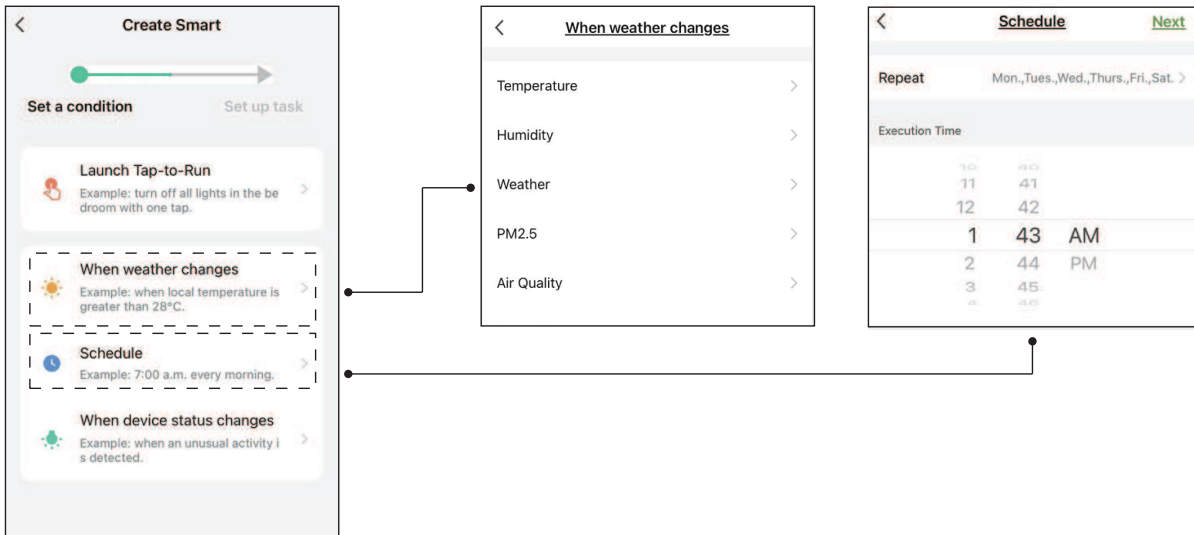

4.2 Task Settings

Set up tasks as your required, then trigger task if conditions are met.

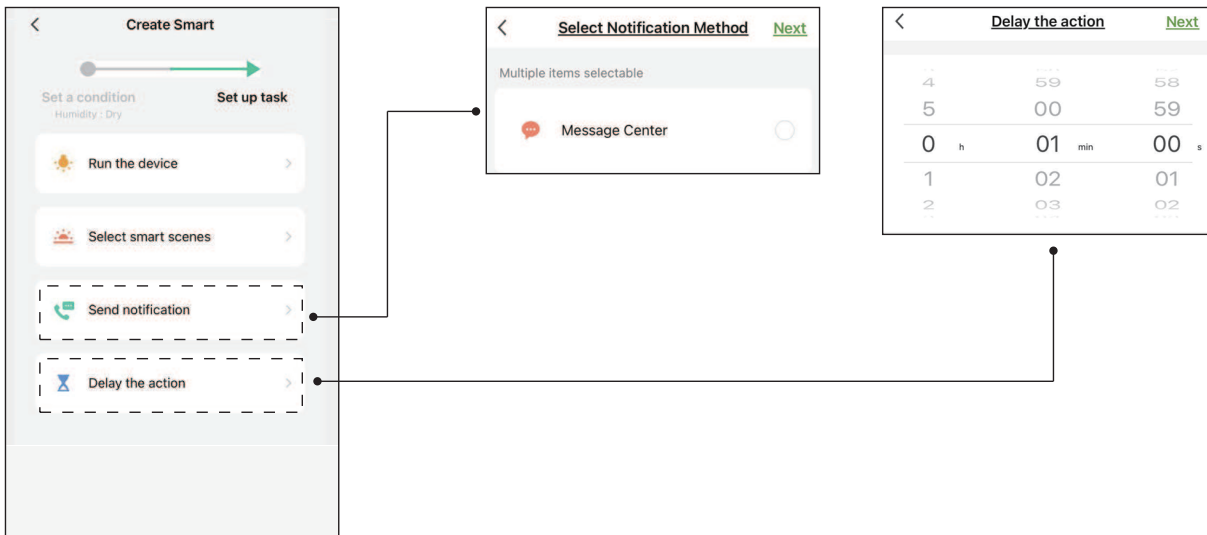

5. Personal Date Interface

Setup arguments and add conditions as your required.

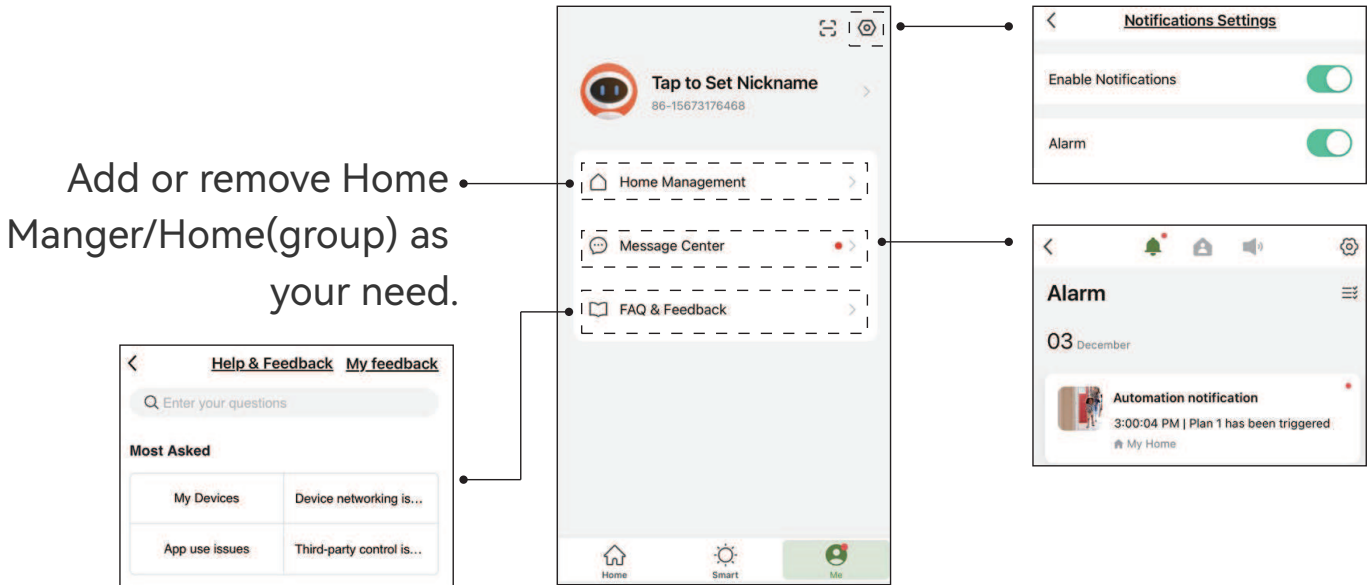

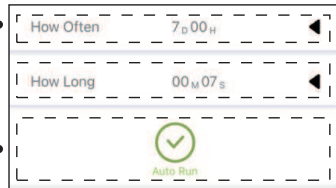

AUTOMATIC WATERING MODE

Step1: Click ◀ to setup watering frequency as your required and "done" it.



Step2: Click ◀ to setup watering duration as your required and "done" it.

Step3: Click  and change  it to .Means that your schedule is running.

Note:

Please remember to action step 3 after the setup is completed, otherwise the program won't run.

MANUAL WATERING MODE -----

1. Manual Operation Via App

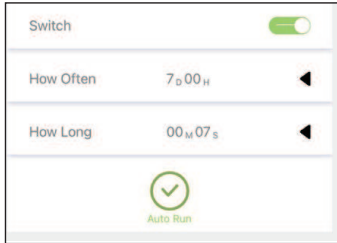

Click the switch to turn ON / OFF manual watering, manual water run time you choose will be the duration your cycle will run for.

Note:

If you want to change the manual irrigation time, please adjust the "How Long" option, and your original watering time also will be overwritten.

2. Manual Operation Via Device



Click the  button to turn ON / OFF manual watering, manual water run time you choose will be the duration your cycle will run for.

RESET THE DEVICE -----

1. Remove the device and erase the data on the app, then cut off the power (remove the battery and unplug the USB cable).
2. Leave the device for about 30-60s.
3. Plug in the USB cable, press and hold the WiFi button until the indicator turns to a fast blinking green light, then open the APP to connect.

TROUBLESHOOTING

Problem	Possible Cause	Possible Solution
WiFi can't be connected	Not in 2.4GHz wifi channel connection	Reset the router for a 2.4G channel and reconnect.
	Too far between the pump and router, causing the signal unstable	Move the pump to a closer socket near the router and reconnect.
	Not in the correct connecting mode	Unplug the USB cable and battery first and wait 10 Sec. Charge the pump with USB cable again, then hold down WiFi button until the indicator light flashes rapidly and enter pairing mode.
Uneven water flow	Too far away from pots and water containers or too long pipes can reduce the pump's pumping efficiency.	The further away from the pump the potted plant is, the weaker the water flow will become. Please use some clamps to hold the first few branches so that the mainstream water can be delivered quickly and for a long time.

Problem	Possible Cause	Possible Solution
Hard to insert and remove water pipes	Because of the material, in order to make the pipe more durable.	Put the head of hose into hot water for 10s or Put a little veggie oil on the end of the hose before connecting.
Watering schedule not on time	The lack of water at the inlet resulted in the plan not being implemented on time.	Check that there is no lack of water in the container at the water inlet and that the pump does not carry out the watering schedule when there is a lack of water.
	There is no auto-run schedule set up on the APP side.	Once the plan parameters have been set, the plan will be executed automatically according to the parameters set by checking "Auto Run".
	The water pump unexpectedly lost power and the plan was emptied.	The watering schedule needs to be reset.

If your Rainpoint product does not operate properly after trying the troubleshooting steps, please contact us by phone or email :
1-833-3815659 (US Hotline) | service@rainpointus.com

WARRANTY -----

Rainpoint provides a 1-year limited warranty on this product against manufacturing defects in materials and workmanship.

CUSTOMER SUPPORT -----

If you find it difficult to set up and want to watch the setting tutorial video, please subscribe to our channel: RainPoint on YouTube.

Please scan the QR code to visit the RainPoint channel on YouTube quickly.



If the app and the user manual don't have what you're looking for, and you need some help, please prepare the Model NO. and LOT NO. of your device and contact us before returning the Rainpoint to the store.

US Free Hotline: 1-833-3815659

Email: service@rainpointus.com

Model NO.: xxxxxxxxxxx(On the timer label)

LOT NO.: xxxxxxxxxxxxxxxxxxx(On the timer label)