

USER MANUAL

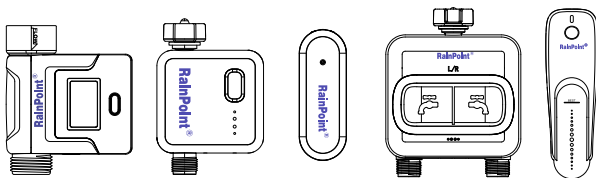
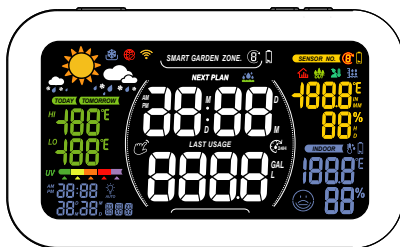

Welcome to the **RAINPOINT** smart family! Please read the manual before using to learn about the features and functions.

Have Questions?

🌐 WEB: www.rainpointonline.com



CONTENTS

1. WI-FI DISPLAY HUB HIS019WRF-DLS	01
1.1 Product Overview	01
1.2 Button Introduction	01
1.3 LCD Screen Overview	02
1.4 Specification	03
2. WORK ON APP	04
2.1 APP Installation	04
2.1.1 Download	04
2.1.2 Before Connection	05
2.2 Connection	06
2.2.1 Smart Connection Mode	06
2.2.2 AP Connection Mode	10
2.3 APP Overview	14
2.3.1 APP Home Page	15
2.3.2 Plan Page	16
2.3.3 Event Page	16
2.3.4 Me and Basic Settings	17
2.3.5 Device Page	18
2.3.6 Device Settings	19
3. BASIC SUB-DEVICES	20
3.1 How to Connect	20
3.2 HTV113FRF -DLS	21
3.3 HTV213FRF -DLS	22
3.4 HCS014ARF -DLS	23
3.5 HCS021FRF -DLS Soil Moisture Sensor	24
3.6 HCS008FRF -DLS Water Flow Meter	25
4. TROUBLESHOOTING	26
5. NOTICE	27
6. WARRANTY POLICY	27
7. FCC STATEMENT	28
8. CUSTOMER SUPPORT	29

1.WI-FI DISPLAY HUB HIS019WRF-V2

1.1 Product Overview

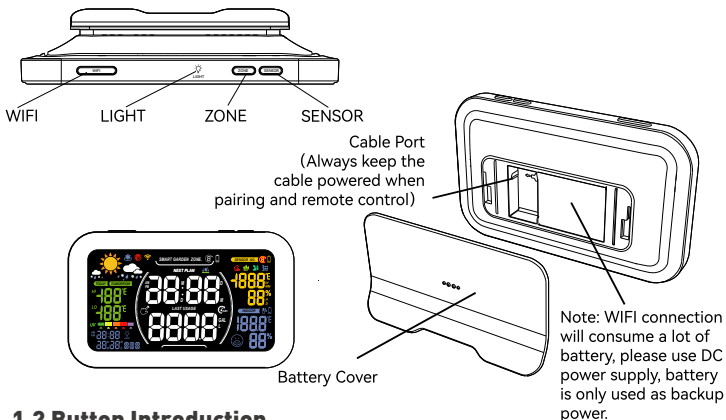

1.2 Button Introduction

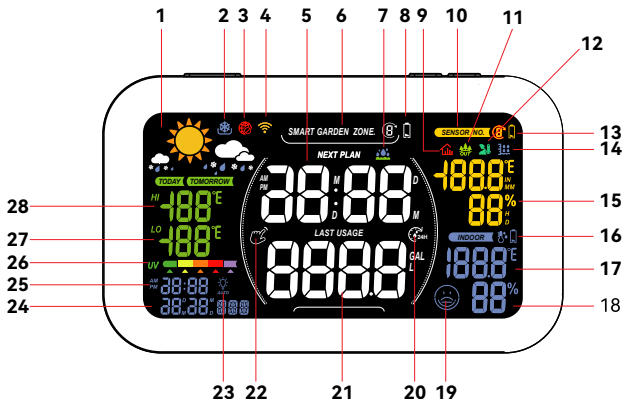

Buttons	Functions
Wi-Fi	<ul style="list-style-type: none">• Hold the button for 5 sec to start Smart Connection Mode• When the device is already in connecting mode, release and then hold the button again for 2 sec to enter AP connection mode
Light	<ul style="list-style-type: none">• Press to adjust the LCD screen backlight brightness
ZONE	<ul style="list-style-type: none">• Press to check each smart garden zone(water timer outlet)• Hold for 2 sec in the chosen zone to manually start watering for 10 mins
SENSOR	<ul style="list-style-type: none">• Press to switch the sensor channels

1.3 LCD Screen Overview



- | | |
|--|--|
| 1. Weather forecast for reference | 15. Data of the sensors (If there is no sensors connect, the screen will show the data on the network) |
| 2. Freezing point alert | 16. Low battery display of hub |
| 3. Failed to connect | 17. The temperature detected by hub |
| 4. WIFI signal indication | 18. The humidity detected by hub |
| 5. Next watering plan time/
Watering remaining time | 19. Indoor comfort level indicator |
| 6. Smart garden zones | 20. Rain delay |
| 7. Watering reminder | 21. Water usage |
| 8. Low battery display of water
timers | 22. Manual watering |
| 9. Indoor thermo-hygrometer | 23. Smart backlight mode |
| 10. Sensor No. | 24. Calender |
| 11. Outdoor thermo-hygrometer | 25. Current time |
| 12. Soil sensor | 26. UV level |
| 13. Low battery display of
sensors | 27. Lowest temperature for today |
| 14. Rainfall sensor | 28. Highest temperature for today |

 To get accurate displays, please keep the devices away from any a freezing place, direct sunlight, rain, or any heat place.

	DRY: Humidity $\leq 40\%$
	COMFORT: $40\% \leq \text{Humidity} \leq 70\%$ $68^{\circ}\text{F}(20^{\circ}\text{C}) \leq \text{Temperature} \leq 82.4^{\circ}\text{F}(28^{\circ}\text{C})$
	WET: Humidity $\geq 70\%$

1.4 Specification

Detect Indoor Temperature: $(9.9^{\circ}\text{C} \sim 50^{\circ}\text{C}) - 14^{\circ}\text{F} \sim 122^{\circ}\text{F}$, $(\pm 1^{\circ}\text{C}) \pm 3.6^{\circ}\text{F}$

Detect Indoor Humidity: $1\% \text{RH} \sim 99\% \text{RH}$, $\pm 5\% \text{RH}$

UV Index: 0~15

5 Levels Backlight: OFF, 10%, 30%, 50%, 100%

Input: 100-240V~50/60Hz 0.3A

Output: 5V-1.2A

Power Supply: 5V DC adapter (included)

or 3 x AA batteries (not included)

(Note: Please use the batteries for back up ONLY.)

2.WORK ON APP

2.1 APP Installation

2.1.1 Download

• HOMGAR APP downloads:



or scan the QR code to download:



IOS



Android

• Create an account and log in:

Follow the instructions to sign up account or log in with an existing account and start matching devices!

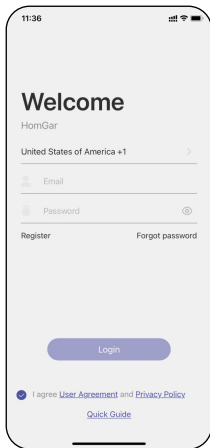

2.1.2 Before Connection

To assure your display hub to connect to Wi-Fi, it will need to meet the following requirements:

- Please make sure the phone is connecting with **2.4GHz Wi-Fi** before using HOMGAR app. The hub has to keep staying under 2.4GHz Wi-Fi to work normally.
- When to start and keep Wi-Fi connection, please keep the power cable on to make sure the hub works normally. **Battery is just for back up.**
- IOS Requirements: Mobile device with iOS 11.0 (or higher) with cellular or Wi-Fi service.
- Android Requirements: Mobile device with Android OS 6.0 (or higher) with cellular or Wi-Fi service
- Please do not use public Wi-Fi networks.
- The hub and device are better to be within 10 feet (3m) during pairing.
- If you need to change the working Wi-Fi network, press and hold Wi-Fi button and recenter your new Wi-Fi information on the APP.

2.2 Connection



Tips:

Please scan the QR code or search the link to access the video to connect the device quickly and easily.

Setup Video: <https://www.youtube.com/watch?v=6tNFDQa3N1k>

2.2.1 Smart WiFi Connection

- Power on the hub with the power cable and follow the steps below to connect:

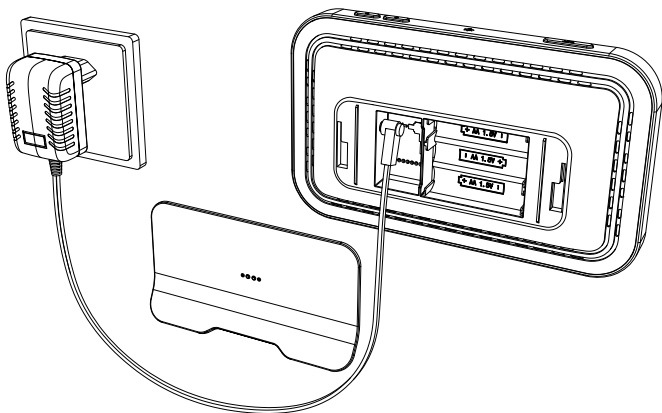

- After register account and get into the APP page, find "+" button on the top right corner of the APP's Home Page.



- Select "Display Hub", then enter the Wi-Fi information and go next.

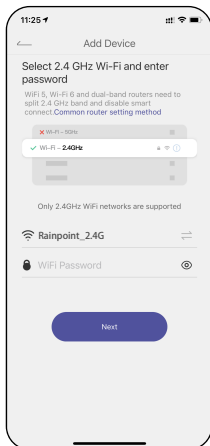
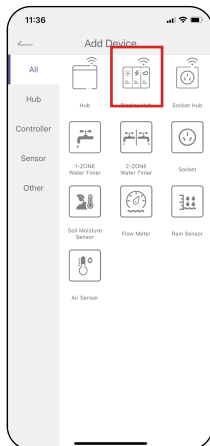

Tips: Please select **2.4Ghz WiFi**

If your router is a dual-band router, and you cannot identify the 2.4Ghz or 5Ghz WiFi, please tap the blue words "**Common router setting method**" to name the 2.4Ghz WiFi differently, then you can select it individually.

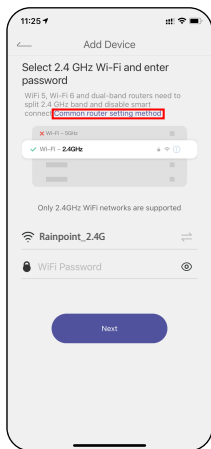

- On the device, press and hold the "**Wi-Fi**" button for about 5 sec until it shows "**SCAN**".



- When **"SCAN"** appears, check **"All steps completed"** box and then select **"Next"** to start searching devices.

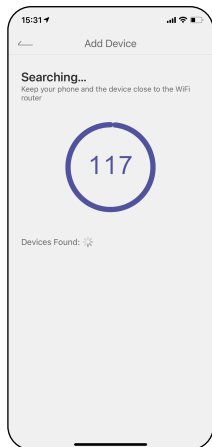

- When device found, select **+** to add the device and enter the name you prefer.



- Congratulations! Now you successfully add the device to your APP.

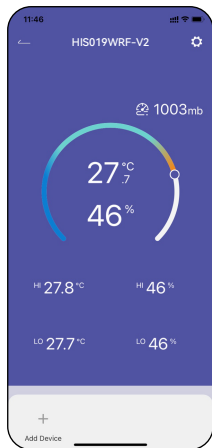

2.2.2 AP Connection

If Smart Connection Mode does not work well, you can also try to use AP Connection Mode.

- Power on the hub with the power cable and follow the steps below to connect:

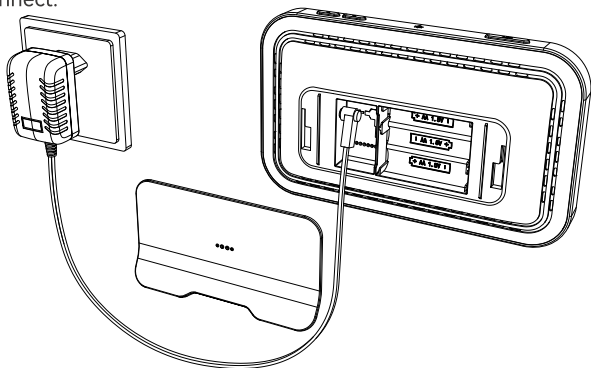

- After register account and get into the APP page, find "+" button on the top right corner of the APP's Home Page.

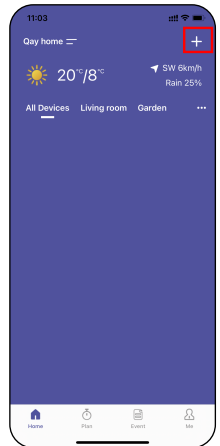

- Select "Display Hub", then enter the Wi-Fi information and go next.

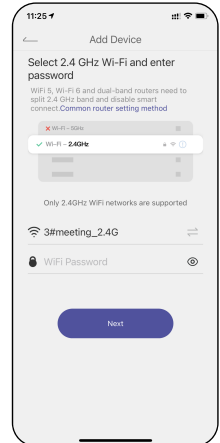
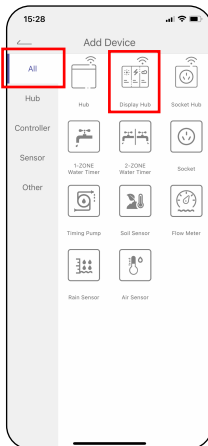

- Click Switch Mode in the upper right corner to switch to AP Connection.



- On the device, press and hold the "Wi-Fi" button for about 5 sec until it shows "SCAN ". Hold the "WiFi" button for 2 seconds until the display shows "AP".

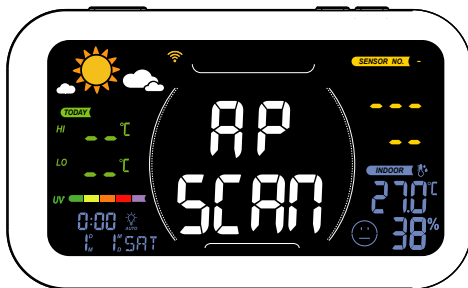

- When "AP SCAN" appears, check "All steps completed" box and then select "Go Connecting" to connect the phone with below the hot spots (HomGar_xxx).

Note: If the phone pops up with no signal and need to switch WiFi, please do not switch to keep Hot spot of connected devices.

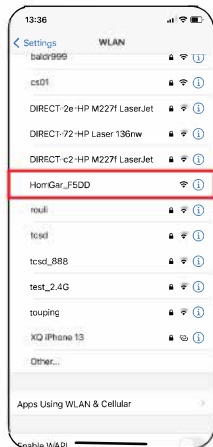
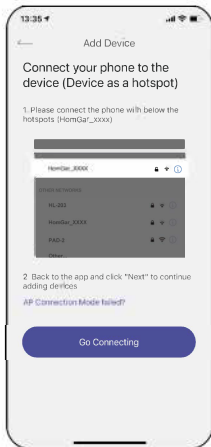

- Back to the app and click "Next" to continue adding devices automatically.



- Congratulations! Now you successfully add the device to your APP.

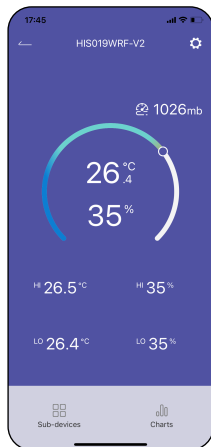

2.3 APP Overview

Tips:

Please scan the QR code or search the link to access the video to operate the device quickly and easily.
Setup Video: <http://bit.ly/3WR5kWP>

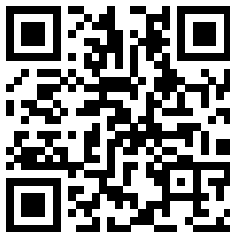

2.3.1 APP Home Page

- **Home Management:** Set home name, location and other information to manage your garden irrigation system intelligently and accurately.
- **All Devices:** All added devices will be displayed here.
- **Local Weather:** the corresponding weather data will be displayed.
- **Room System Management:** After setting the location of the home, Show the related devices in different rooms.
- **Add Devices:** Add the Smart + series devices to start setup your system management.
- **Home:** The APP home page.

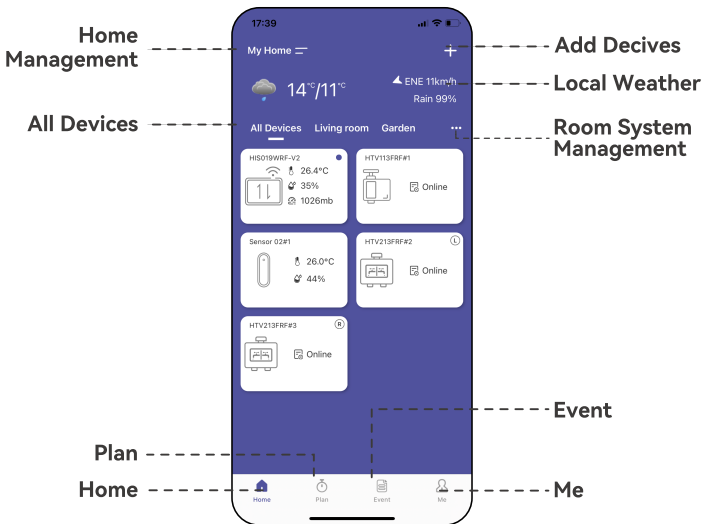

2.3.2 Plan Page

List all of your irrigation plans for water timers. You can manually turn on or off the plan by the button on the right.

There is also a manual Rain Delay button to put off all plans if there is raining.

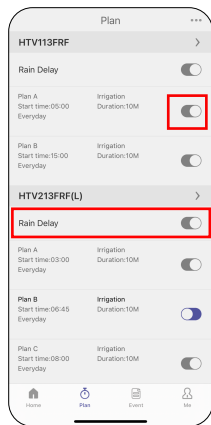

2.3.3 Event Page

Review all the events that have occurred. Learn more about how your smart system works.

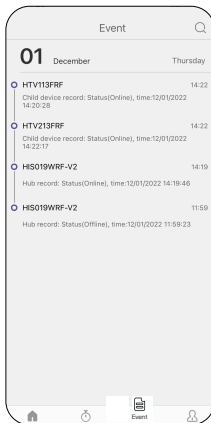

2.3.4 Me and Basic Settings

Manage your account, home, basic settings, and other options. You can also find unit format and notification button in these settings.

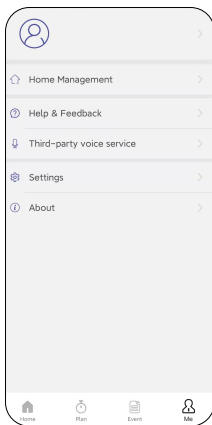

Notes: After the hub and sub-devices are connected, the selection of the sub-devices will be displayed on both the APP home page and the hub's device page. You can click the device icons in the **"All Devices"** list to enter the device page, or find them in the **"Sub-devices"** list on the hub's device page.

2.3.5 Device Page



1. Device Setting
2. Barometric Pressure
3. Current Temperature and Humidity
4. The Highest and Lowest Temperature
5. The Highest and Lowest Humidity
6. Sub-device Management
7. Device Data Chart

2.3.6 Device Settings

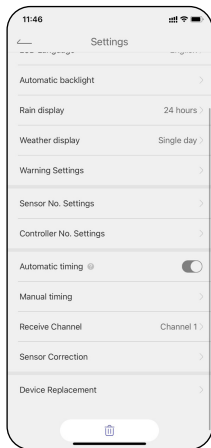

Tips:

1. **Rain display** needs to work with the rain gauge, which is purchased separately.
2. **Weather display** is the weather display for only today or both today and tomorrow.
3. **Warning settings** is to set the alert for specific values of temperature and humidity.
4. **Sensor No. Settings** is to set the display order for the sensors and controllers.
5. **Timing** settings need to work with the precision clock, which is purchased separately.
6. **Receive Channel** is only for when the sub-devices cannot be connected. You don't need to change it unless you have to.

3.BASIC SUB-DEVICES

3.1 How to Connect

If you need to connect the sub-device, please connect the hub or display hub of Rainpoint Smart+ series first.

There are two ways you can connect the sub-devices:

"Add Device" button on the top right corner of the APP home page

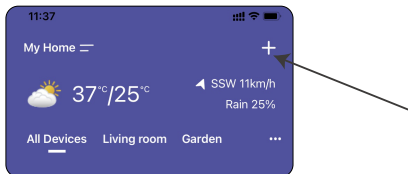

"Sub-devices" management in the hub's device page

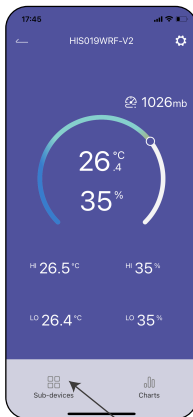

3.2 HTV113FRF-DLS Smart 1-Zone Water Timer

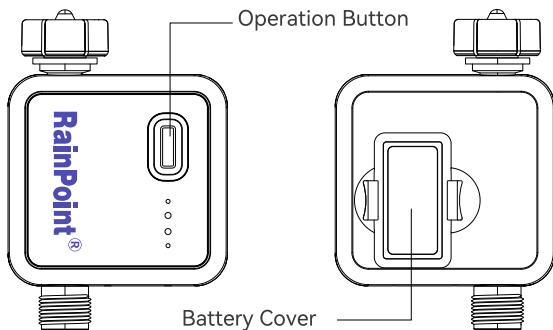

1. Find **"1-ZONE Water Timer"** or the icon  to add HTV113FRF-DLS Smart 1-Zone Water Timer when adding sub-devices.
2. Inset the batteries, and then the indicator will quickly blink in red. At the same time, select **"NEXT"** on the APP and start searching devices.
3. Keep the timer and the hub close to each other, and they will connect automatically.
4. Besides that, you can also hold the button to reset and connect again.
5. After successfully connecting, the next watering plan time for each valve will display in the middle of the hub's screen.
6. You can also hold the ZONE button on the hub to manually turn on the valve for 10 mins.

Tips:

If you need more detail information about the operation, please scan the QR code or search the link to access the video to check the device quickly and easily.

Setup Video: <http://bit.ly/3jgJQVA>

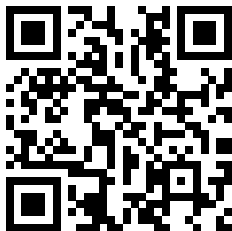

3.3 HTV213FRF-DLS Smart 2-Zone Water Timer

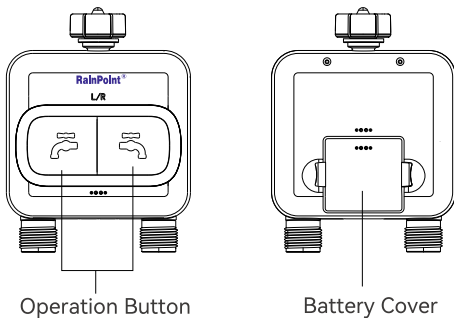

1. Find **"2-ZONE Water Timer"** or the icon  to add HTV213FRF-DLS Smart 2-Zone Water Timer when adding sub-devices.
2. Inset the batteries, and then the indicator will quickly blink in red. At the same time, select **"NEXT"** on the APP and start searching devices
3. Keep the timer and the hub close to each other, and they will connect automatically.
4. Besides that, you can also hold the button to reset and connect again.
5. After successfully connecting, the next watering plan time for each valve will display in the middle of the hub's screen.
6. You can also hold the ZONE button on the hub to manually turn on the valve for 10 mins.

Tips:

If you need more detail information about the operation, please scan the QR code or search the link to access the video to check the device quickly and easily.

Setup Video: <http://bit.ly/3jIUEBV>

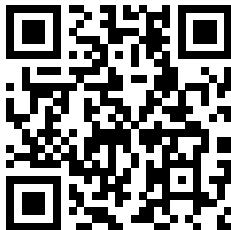

3.4 HCS014ARF-DLS Outdoor Thermo-Hygrometer Sensor

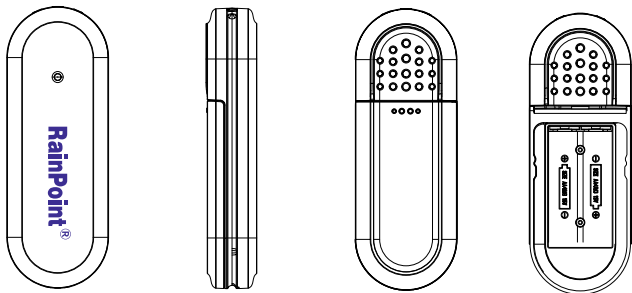

1. Find **"Air Humidity Sensor"** or the icon  to add HCS014ARF-DLS Outdoor Thermo-Hygrometer Sensor when adding sub-devices.
2. Select **"Next"** and start searching devices. At the same time, insert the batteries, and then the red indicator will quickly blink once. Please make sure the APP is already in searching before power on the sensor.
3. Keep the timer and the hub close to each other, and they will connect automatically.
4. After successfully connecting, the detected data will display in right side of the hub's screen under **"SENSOR"**.

Tips:

If you need more detail information about the operation, please scan the QR code or search the link to access the video to check the device quickly and easily.

Setup Video:

<https://www.youtube.com/watch?v=fRiQhy-CqOwg>



3.5 HCS021FRF-DLS Soil Moisture Sensor

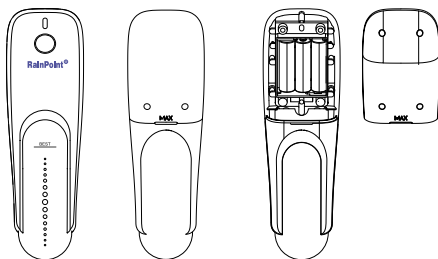

1. Find " **Soil Moisture Sensor** " or the icon  to add the sensor.
2. Inset the batteries, and then the indicator will quickly blink in red. At the same time, select " **NEXT** " on the APP and start searching devices.
3. Keep the sensor and the hub close to each other to connect automatically.
4. Besides that, you can also hold the button to reset and reconnect if you fail to connect for the first time.
5. After successfully connecting, the real-time soil moisture and surface temperature will display on the top right corner of the hub's screen.

Tips:

If you need more detail information about the operation, please scan the QR code or search the link to access the video to check the device quickly and easily.

Setup Video: <http://bit.ly/3jIwZle>

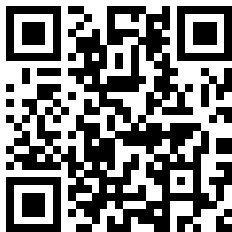

3.6 HCS008FRF-DLS Water Flow Meter

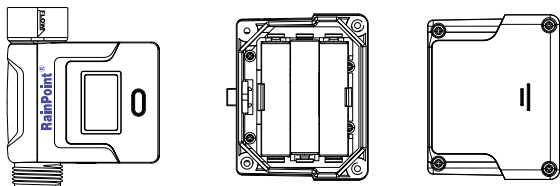

1. Find "**Flow Meter**" or the icon  to add the sensor.
2. Insert the batteries and the flow meter will get into the pairing mode automatically. At the same time, select "**NEXT**" on the APP and start searching devices.
3. Keep the sensor and the hub close to each other to connect automatically.
4. Besides that, you can also re-insert the batteries to reset and reconnect if you fail to connect for the first time.
5. After successfully connecting, the real-time water flow rate and other information will show on the device home page.

Tips:

If you need more detail information about the operation, please scan the QR code or search the link to access the video to check the device quickly and easily.

Setup Video: <http://bit.ly/3WMKuYF>

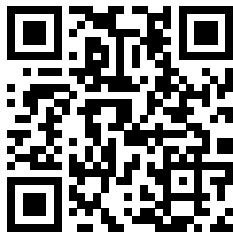

4. TROUBLESHOOTING

Problems	Some Solution
Power problem	<ol style="list-style-type: none">1. The display hub uses 5V adaptor as the main power source, and batteries used only as a backup.2. Replace a new adaptor. It is important to use the correct adaptor on all electronic equipment.
Disconnection	<ol style="list-style-type: none">1. Batteries often resolve the connection.2. Distance/Resistance may cause loss of connection between the sensors/sub-devices and the display hub.3. Please make sure the wifi network works normally and stabled.4. Try to restart the device and reconnect.
Outdoor sensor drains batteries quickly	<ol style="list-style-type: none">1. Check the distance and resistance between the outdoor sensor and display hub. Outdoor sensors at the end of the range may work while batteries are fresh but not after they drain a bit.2. Check if leaking batteries, which may damage the outdoor sensor.3. Battery life is over 12 months only using Alkaline batteries. Mixed using of used and new batteries, using Carbon batteries or rechargeable batteries may reduce battery life.
Device offline	<ol style="list-style-type: none">1. Check if the battery is fully charged or the power supply is normal.2. Poor network signal or too far from the router.

5. NOTICE

- Please make sure to use 2.4GHZ band WIFI to connect to this product.
- To operate smoothly and correctly, please place the weather station gateway on a stable plane for use.
- Do not mix old and new batteries or different types of batteries.
- Do not block the vent, insert fingers, or any objects, as this may cause equipment failure or other conditions.
- Do not use the product near gas, heaters, microwave ovens, and other positions that may cause interference.
- Do not wipe the screen with corrosive reagents, which may affect the screen display.
- Under freezing temperatures, timers should be removed from the faucet and stored indoors to avoid potential freezing damage.
- Please clean the filter regularly and replace it if worn to prolong the timer's working life.

6. WARRANTY POLICY

RAINPOINT provides a 1-year limited warranty on this product against manufacturing defects in materials and workmanship.

7.FCC STATEMENT: (FCC ID:2AWDBHIS019WRF)

This device complies with Part 15 of the FCC Rules. Operation is subject to the following two conditions:

- (1) This device may not cause harmful interference, and
- (2) this device must accept any interference received, including interference that may cause undesired operation.

FCC Warning: Any changes or modifications not expressly approved by the party responsible for compliance could void the user's authority to operate this equipment.

Note: This equipment has been tested and found to comply with the limits for a Class B digital device, pursuant to Part 15 of the FCC Rules. These limits are designed to provide reasonable protection against harmful interference in a residential installation. This equipment generates, uses, and can radiate radio frequency energy and, if not installed and used in accordance with the instructions, may cause harmful interference to radio communications. However, there is no guarantee that interference will not occur in a particular installation. If this equipment does cause harmful interference to radio or television reception, which can be determined by turning the equipment off and on, the user is encouraged to try to correct the interference by one of the following measures:

- Reorient or relocate the receiving antenna.
- Increase the separation between the equipment and the receiver.
- Connect the equipment into an outlet on a circuit different from that to which the receiver is connected.
- Consult the dealer or an experienced radio/TV technician for help.

Note: The manufacturer is not responsible for any radio or TV interference caused by unauthorized modifications to this equipment. Such modifications could void the user's authority to operate the equipment.



Made in China



Not included



Points de collecte sur www.quefairedesdechets.fr
Privilégiez la réparation ou le don de votre appareil !

8. CUSTOMER SUPPORT

If you find it difficult to set up and want to watch the setting tutorial video, please subscribe to our channel: Rainpoint on YouTube.

Please scan the QR code to visit the RainPoint channel on YouTube quickly.



If the app and the user manual don't have what you're looking for, and you need some help, please prepare the Model NO. and LOT NO. of your device and contact us before returning the Rainpoint to the store.
LOT NO.: XXXXX (on the back of the device)

