

Extrusion Machines (Typical)

Fits over Ceramic and Mica Band Heaters
Zone Insulation Between Thermocouples
Covered Terminal Box or Screw Terminals

How To Order

To process an order or quote
please specify the following
information

"C" = Circumference of Heater
Bands and J-Boxes
"W" = Width Between
Thermocouples

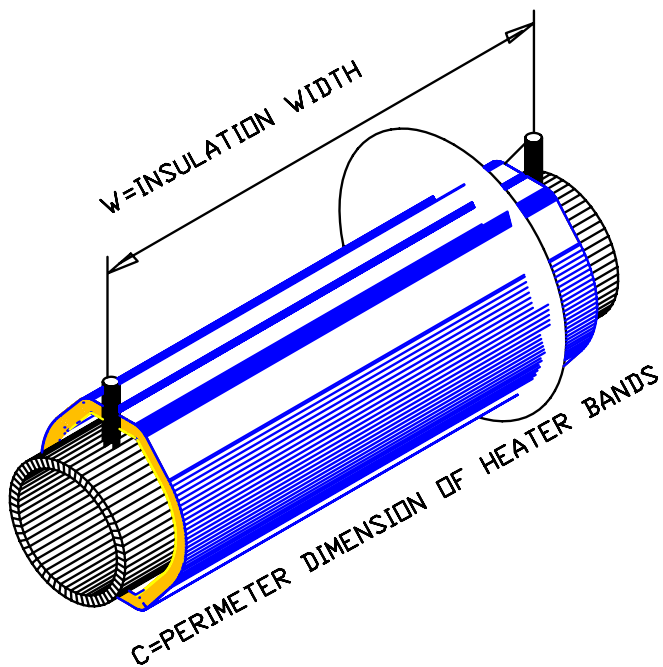
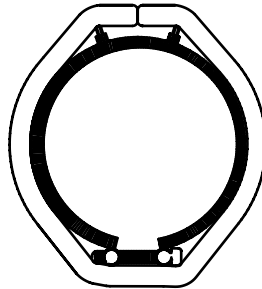

LINE # _____

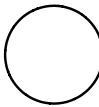
C  W _____

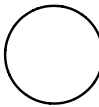
C  W _____

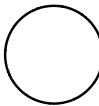
C  W _____

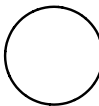
C  W _____

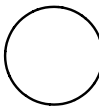
C  W _____

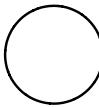
C  W _____

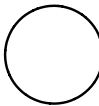
C  W _____

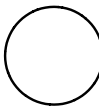
C  W _____