

Force5™ 2.0 Industrial

Cellular Signal Booster for voice and 4G data with Built-In Sentry Monitoring

User Guide

Table of Contents

CONTENTS

Chapter 1: Introduction	3
1.1 Package Contents	3
1.2 Features & Benefits	3
1.3 Additional Items Needed.....	3
1.4 How Cellular Signal Boosters Work.....	4
Chapter 2: Safety	4
2.1 Safety Warnings	4
Chapter 3: Planning The Installation	6
3.1 Installation Overview	6
3.2 Exterior Antenna	7
3.3 Interior Antennas	8
3.4 Antenna Separation.....	9
3.5 Calculating Signal Strength.....	10
3.6 Booster Location	12
3.7 Accessories.....	12
3.8 Need Help?	12
Chapter 4: Installation	13
4.1 Soft Installation	13
4.2 Exterior Antenna	13
4.3 Interior Antennas	14
4.4 Mounting the BDA	15
Chapter 5: Configuration & Testing	16
5.1 Powering on the BDA	16
5.2 DIP Switch Configuration.....	16
5.3. DIP Switch organization	17
5.4 LED Conditions.....	18
5.5 Testing & Troubleshooting	19
Chapter 6: Sentry Configuration	20
6.1 Software Installation	20
6.2 Hardware Installation.....	20
6.3 User Registration.....	21
6.4 Device Registration	22
6.5 Device Configuration.....	22
6.6 Using Antenna Placement Tool.....	25
6.7 Over Power Alert	26
Chapter 7: Specifications	28
7.1 Suggested Kitting Options	29
7.2 Installer Warning.....	29
Chapter 8: Warranty	30
8.1 Warranty Periods	30
8.2 Three-Year Product Warranty.....	30
8.3 Limitations of Warranty, Damages and Liability	31

CHAPTER 1: INTRODUCTION

Introducing SureCall's Force5 2.0 Industrial Booster. Please read this entire manual before proceeding.

1.1 Package Contents

Your booster box contains the following items:

- (1) Force5 2.0 Industrial Booster and mounting kit and power supply

1.2 Features & Benefits

The booster offers the following features and benefits:

- Five band signal booster that enhances cellular voice, text and 4G LTE signals
- Extends cellular signals in areas with poor coverage due to geographical location and/or building design
- Highly linear amplifier producing the fastest 4G LTE data rates
- Powerful in-building booster with 31 dB of adjustable gain level
- Automatic oscillation detection and protection system powers down the booster to prevent harmful radio interference
- Maximum output power is 3 watts EIRP for Cellular, 2 watts EIRP for PCS and 1 watt for AWS 1710-1755 MHz bands. Fixed stations operating in the 1710-1755 MHz bands are limited to a maximum antenna height of 10 meters above ground

1.3 Additional Items Needed

The booster requires the following additional components for a complete installation:

- An outside antenna, such as the SC-230W Yagi antenna or SC-288W omni antenna
- Sufficient low loss 50 ohm interior/exterior cable
- Cable splitter for multiple indoor antennas
- Multiple indoor antennas (such as SC-222W dome or SC-228W Ultra Thin™ omni-directional ceiling mount antennas, or SC-248W directional wall mount antenna by SureCall)
- Grounded surge suppressor for DC power supply
- Lightning Protector (SC-LP)

Safety

1.4 How Cellular Signal Boosters Work

The Force5 2.0 industrial booster amplifies cellular signals from the nearest towers to phones in a building and from those phones back to the tower to compensate for weak reception caused by distance, topography, building structure, among other reasons.

The booster receives the signal from an outside antenna, amplifies that signal and rebroadcasts it indoors via the interior antenna(s) where it is received by cellular devices. The interior antennas also pick up signals from cellular devices and pass them to the booster. The booster amplifies these signals and passes them to the exterior antenna for rebroadcast back to the tower.

CHAPTER 2: SAFETY

This chapter contains important safety information designed to prevent personal injury, equipment malfunction, and/or radio interference. You are responsible for ensuring a safe installation.

2.1 Safety Warnings

- You are responsible for knowing and following all applicable codes and regulations and for obtaining all required permits and inspections.
- Follow all safety precautions contained in this Installation Manual.
- The installation process may require working in high locations such as roofs and/or ladders. Follow applicable safety regulations and best practices to injury. Take care not to drop objects off any high area. Cordon off ground areas directly below roof or ladder work.
- Always use appropriate personal protective equipment such as goggles, gloves, hard hat, etc. as needed or required.



WARNING: FAILURE TO EXERCISE CAUTION WHEN WORKING IN HIGH AREAS COULD CAUSE A FALL AND PERSONAL INJURY.

- Some components may be heavy and/or bulky. Always use proper lifting and carrying techniques when handling components, especially when working on a ladder, roof, or other area with a fall hazard.
- The exterior antenna must not be co-located or operating in conjunction with any other antenna.
- Always use a properly installed SureCall lightning protector between the exterior antenna and the booster.



CAUTION: FAILURE TO PROPERLY INSTALL A LIGHTNING PROTECTOR CAN RESULT IN DAMAGE TO THE BOOSTER, ANTENNAS, AND WIRING.

- Always power off the booster before working on the roof of the building or anywhere in close proximity to the external antenna.
- Allow at least 24 inches (60 cm) of separation between interior antennas and humans or animals.
- Allow at least 24 inches (60 cm) of separation between exterior antennas and all persons.
- Comply with all antenna separation requirements to prevent signal oscillation.



CAUTION: SIGNAL OSCILLATION CAN CAUSE RADIO INTERFERENCE WITH CELLULAR TOWERS AND RESULT IN CIVIL AND/OR CRIMINAL PENALTIES.

CHAPTER 3: PLANNING THE INSTALLATION

3.1 Installation Overview

Typically, a BDA installation follows these steps:

1. Decide what type of exterior antenna to use, and where to mount it. You will use either an omnidirectional antenna, mounted vertically, or a directional Yagi antenna, pointed directly at the radio tower (line of sight). The antenna will normally be mounted on the roof of the building or wall with the strongest signal. A grounded lightning protector (SureCall part SC-LP) is required between the exterior antenna and the BDA.
2. Decide where to mount the interior antenna(s), being sure to take separation requirements into account. Long, narrow spaces benefit most from directional flat-panel antennas, while more square spaces benefit more from omnidirectional dome antennas.
3. Decide where to mount the BDA. This should be in a secure indoor location near a grounded power source.
4. Decide where to route the cables between the exterior antenna and the BDA and between the BDA and interior antennas.
5. Install the antennas as described in their respective Installation Manuals.
6. Route the cables to the BDA location.
7. Install the BDA as described in this manual.
8. Power on the BDA and perform configuration and testing explained in Chapter 5.



CAUTION: FAILURE TO PROPERLY INSTALL A LIGHTNING PROTECTOR CAN RESULT IN DAMAGE TO THE BDA, ANTENNAS, AND WIRING.

Important Installation Safety Precautions:

- Some components may be heavy and/or bulky. Always use proper lifting and carrying techniques when handling components, especially when working on a ladder, roof, or other area with a fall hazard.
- The exterior antenna must not be co-located or operating in conjunction with any other antenna.
- Always use a properly installed SureCall lightning protector between the exterior antenna and the BDA.
- Always power off the BDA before working on the roof of the building, or anywhere in close proximity to the external antenna.

- Allow at least 24 inches (60cm) of separation between interior antennas and humans or animals.
- Allow at least 24 inches (60cm) of separation between exterior antennas and all persons.
- Comply with all antenna separation requirements to prevent signal oscillation.



CAUTION: SIGNAL OSCILLATION CAN CAUSE RADIO INTERFERENCE WITH RADIO TOWERS AND RESULT IN CIVIL AND/OR CRIMINAL PENALTIES.

3.2 Exterior Antenna

You may use either an omnidirectional antenna that covers flat areas with no obstructions or a directional Yagi antenna to point directly at the tower. The omnidirectional antenna receives and transmits signals over a horizontal 360-degree circle. The Yagi antenna receives and transmits signals over a focused area and must be aimed directly (line of sight) toward the radio tower that provides the strongest signal to the building.

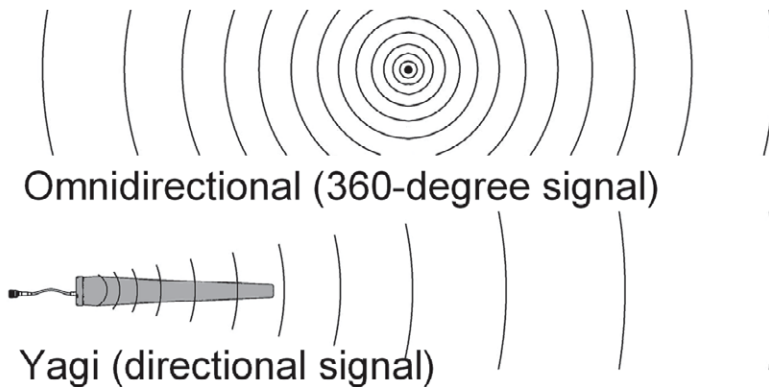

The exterior antenna and mast (if any) must be mounted in a location that meets all of the following criteria:

- Best signal strength.
- Not co-located with other antennas or used in conjunction with other antennas.
- Away from all power lines.
- At least 6 ft. from lightning rod antennas.
- At least 24 in. from any person.

Planning

3.3 Interior Antennas

You may use any combination of omnidirectional (dome) and/or directional (flat panel) interior antennas to obtain balanced signal strength throughout the structure.

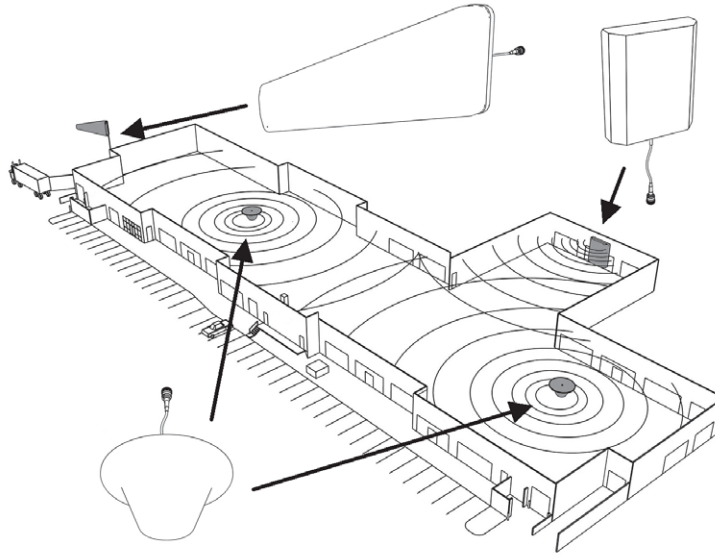

Dome antennas provide 360-degree hemispherical coverage suitable for mostly square areas, while flat panel antennas provide a focused zone of coverage suitable for long narrow areas. The example above uses two dome antennas and one panel antenna to provide full coverage

Keep in mind that floor structures in multistory buildings can cause significant signal loss, which means that you may need to install interior antennas on more than one floor. Here is an example of a multistory installation:

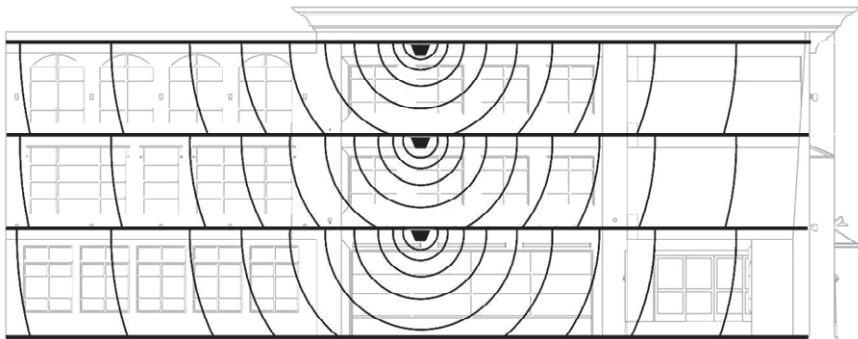

Note: You may not need antennas on every floor of a multistory building, depending on factors such as building material, BDA gain, etc.

3.4 Antenna Separation

Proper antenna separation prevents signal oscillation (feedback) that can interfere with the radio tower. Separation is measured in a straight line from the exterior antenna to the closest interior antenna. The closest allowable distance depends on a number of factors, such as BDA gain level, building material, etc. Recommended separation distances are:

Amplifier gain	Min. separation (ad)
40 dB	5'-6'
45 dB	15'-20'
50 dB	50'
55 dB	60'
65 dB	75-80'
70 dB	100'
75 dB	100'-120'
80 dB	120'-180'

Vertical separation is more important than horizontal separation. If you are unable to obtain the required separation horizontally, try raising the exterior antenna. Should other methods fail, you may also try reducing the BDA gain as described in Chapter 5 of this manual.

Planning

Antenna Safety Precautions:

You can mix and match dome and directional antennas as needed to obtain proper coverage throughout the building or area where you need to boost the signal. If you use a Yagi exterior antenna, you should normally aim it away from all interior antennas, regardless of separation, to prevent oscillation.

Antenna Aiming

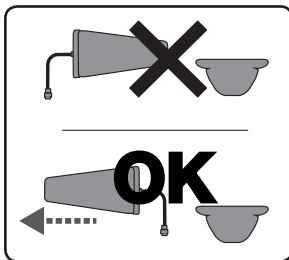

CAUTION: SIGNAL OSCILLATION CAN CAUSE RADIO INTERFERENCE WITH RADIO TOWERS AND RESULT IN CIVIL AND/OR CRIMINAL PENALTIES.

3.5 Calculating Signal Strength

You can calculate the number of antennas you will need using the following parameters (in dB):

- Outside signal level (OSL): This is the signal strength at the exterior antenna location and will always be a negative number that will usually fall between -50 and -100 dBm. Calls will drop at levels of about -100 dB and lower. A system installed in an area where the signal is -85 or worse will require some detailed engineering to achieve an acceptable solution.
- Outside antenna gain (OAG): This is the signal boost provided by the exterior antenna and is always a positive number with SureCall antennas.

OAG	Gain
SC-288W omni	+3

- Inside antenna gain (IAG): This is the signal boost provided by an interior antenna and is always a positive number with SureCall antennas.

IAG	Gain
SC-222W omni dome	+3

- Cable loss (CL): This is the signal loss caused by the cable and is always a negative number.

CL	Loss
20 ft. SC-400	-1 dB / -2 dB
30 ft. SC-400	-2 dB / -4 dB
50 ft. SC-400	-3 dB / -6 dB
100 ft. SC-400	-4 dB / -8 dB

- Splitter loss (SL): This is the signal loss caused by a splitter (used if you are installing multiple antennas).

SL	Loss
2-way	-3
3-way	-5
4-way	-6

- Booster gain (AG): Number of decibels of amplification provided by the booster (rated gain less any attenuation, as described in Chapter 5 of this manual). This is always a positive number.

The signal strength S at an interior antenna equals $OSL+OAG+IAG+CL+SL+AG$.

Planning

3.6 Booster Location

Select an indoor location for the BDA that meets the following criteria:

- Wall or ceiling mounts are both acceptable.
- Near a properly grounded 110VAC outlet.
- Avoid in a tightly enclosed or overly hot spaces.
- All power and warning lights are easily visible.
- You can use the shortest cables to connect all antennas.

3.7 Accessories

The final step in the planning process is to make sure you have all of the necessary accessories to complete the installation. You will need all of the items listed in Chapter 1 of this manual plus some or all of the following:

- Cable clips: Use these to secure the cables to interior and exterior walls/ceilings.
- Appropriately rated sealant/caulking: Use this to waterproof the opening where the cable from the exterior antenna enters the building, if needed.
- Hand and/or power tools: As needed to complete the installation.
- Personal Equipment (PPE): Use all PPE required by local codes and/or best practices to help ensure personal safety during installation.



CAUTION: YOU ARE RESPONSIBLE FOR ENSURING THAT THE INSTALLATION MEETS ALL APPLICABLE CODES.

Note: You may need to obtain a permit from your local building department to install the BDA and antennas. Check your local building and/or electrical codes.

3.8 Need Help?

If you need help planning your installation, contact a qualified installer, the reseller who supplied you with the BDA, or SureCall:

Call: 1-888-365-6283, 7 a.m. to 5 p.m. PST, Monday – Friday

Email: support@surecall.com

CHAPTER 4. INSTALLATION

4.1 Soft Installation

Perform a “soft” installation of all components to test signal coverage and oscillation before making the installation permanent. Avoid making holes or other permanent attachments during this phase. Refer to Chapter 5 for configuration and testing instructions. Proceed with final installation once configuration and testing are complete.

4.2 Exterior Antenna

Mount the exterior antenna in the location you selected during the planning process. Be sure to follow all of the instructions included with the antenna to ensure a safe installation. Remember:

- An omni-directional antenna (e.g., SC-288W) must be mounted vertically.
- A directional Yagi antenna (e.g., SC-230W) must be mounted horizontally and be aimed at the desired cellular tower (line of sight)
- Mount the antenna.
- Connect a length of cable to the antenna and tighten.
- Run the cable along the planned route.
- Install a properly grounded SC-LP lightning protector.
- Seal any holes you make in the outside of the building with caulking or sealant.



WARNING: FAILURE TO EXERCISE CAUTION WHEN WORKING IN HIGH AREAS COULD CAUSE A FALL AND PERSONAL INJURY.



WARNING: DO NOT TOUCH ANY LIVE ELECTRICAL WIRES OR ALLOW THE ANTENNA OR CABLING TO TOUCH ANY LIVE ELECTRICAL WIRES.



CAUTION: AVOID AIMING A YAGI ANTENNA TOWARD ANY INTERIOR ANTENNA.

Installation

4.3 Interior Antennas

Mount the interior antenna(s) in the location(s) you selected when planning. Follow all instructions included with the antenna(s) to ensure the installation(s) are implemented properly.

Here are a few reminders and essential steps:

- Dome antennas are mounted on the ceiling as close to the center of the desired coverage area as possible, domed (convex) side pointing down.
- Flat panel antennas should be wall-mounted as close as possible to the center of the wall, or at one end of long narrow space.
- Mount the antenna(s).
- Connect a length of cable to the antenna and tighten.
- For multiple antennas, run the cable to the splitter location and connect the cable to one of the outputs on the splitter.
- Connect another length of cable to the input side of the splitter (if used) and run this cable to the BDA location.
- It is important to keep the cable runs equal or use taps to ensure a harmonious install.



CAUTION: VERIFY THAT ALL INTERIOR ANTENNAS MEET THE SEPARATION REQUIREMENTS DESCRIBED IN THE PREVIOUS CHAPTER, AND THAT NO ANTENNA IS AIMED TOWARD THE EXTERIOR ANTENNA.



CAUTION: DO NOT CONNECT AN INTERIOR ANTENNA TO THE SPLITTER INPUT.

4.4 Mounting the BDA

Mount the booster as follows:

- Verify that the selected location meets all criteria described in the previous chapter.
- Attach the included mounting kit to the booster using the screws provided. Tighten the screws by hand with a screwdriver until tight plus 1/4 to 1/2 turn. Do not over-tighten.
- Place cardboard template in desired location to and use to mark the places for each screw.
- Use wall anchors along with provided screws to secure into the 4 places marked from the template as shown. When securing screws, allow enough space for the booster mounting tabs to hang from.
- Slide the booster mounting tabs onto the secured screws and verify security. Once the plywood is secure, attach booster to the plywood base using the screws provided. In most installations, the housing will be oriented so the I/O ports are facing down.
- Connect the outdoor antenna cable to the signal booster connector port marked OUTSIDE and tighten the connection.
- Connect the outdoor antenna cable to the signal booster connector port marked INSIDE and tighten the connection.



CAUTION: DO NOT POWER ON THE BDA UNTIL INSTRUCTED TO DO SO.



CAUTION: NEVER POWER ON THE BDA WHEN ANY ANTENNAS ARE DISCONNECTED AS THIS COULD DAMAGE THE BDA.

CHAPTER 5: CONFIGURATION & TESTING

5.1 Powering on the BDA

To power on the booster:

1. Make sure that exterior and interior antenna cables are firmly connected to the proper ports on the booster.
2. Plug a surge suppressor into a grounded 110 VAC wall outlet.
3. Plug the AC end of the supplied power adapter into the surge suppressor.
4. Plug the DC end of the power adapter into the Power port on the booster.
5. Verify that the green **Power** light is illuminated.
6. When the booster is turned on, the band lights will flash red and yellow for approximately 10 seconds.



CAUTION: ONLY USE THE POWER SUPPLY INCLUDED WITH THE BDA. USE OF ANOTHER POWER SUPPLY COULD DAMAGE THE BDA AND/OR POWER SUPPLY.



CAUTION: DO NOT PROCEED BEYOND THIS POINT UNTIL THE BDA IS POWERED ON AND NO RED WARNING LIGHTS ARE ILLUMINATED.

5.2 DIP Switch Configuration

By default, your booster ships with all DIP switches turned OFF to provide maximum gain in all channels. This should always be your starting point whenever installing or reinstalling the booster. When the booster is turned on, the band lights will flash red and yellow for approximately 10 seconds. The following diagrams and notes explain how to interpret, and use, these switch banks.

5.3. DIP Switch organization

1. LTE-UL AT&T (707 MHz) DIP switches control LTE uplink (switch 1-5)
2. LTE-DL (728-757 MHz) DIP switches control LTE downlink (switch 1-5)
3. LTE-UL Verizon (781 MHz) DIP switches control LTE uplink (switch 1-5)
4. CELLULAR-UL (800 MHz) DIP switches control Cellular uplink (switch 1-5)
5. CELLULAR-DL (800 MHz) DIP switches control Cellular downlink (switch 1-5)
6. PCS-UL (1900 MHz) DIP switches control PCS uplink (switch 1-5)
7. PCS-DL (1900 MHz) DIP switches control PCS downlink (switch 1-5)
8. AWS-UL (2100 MHz) DIP switches control AWS uplink (switch 1-5)
9. AWS-DL (2100 MHz) DIP switches control AWS downlink (switch 1-5)

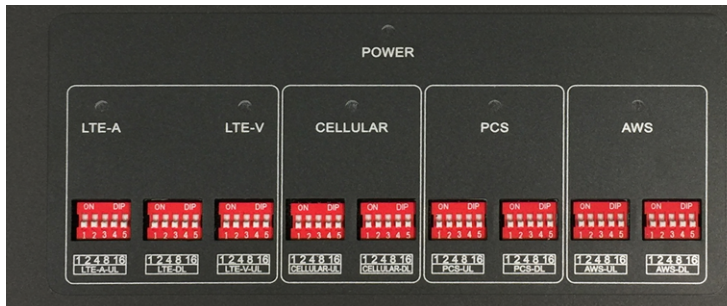

Switches should be OFF unless red flashing lights occur for a channel or channels. Red flashing lights indicate the system has detected oscillation for the corresponding channel(s). They then turn off if adjustments are not made. When adjusting the booster, full power is not always the best option. Your goal is to obtain a usable signal in as many areas of the building as possible.

Switch 1	Switch 2	Switch 3	Switch 4	Switch 5
1 dB	2 dB	4 dB	8 dB	16 dB

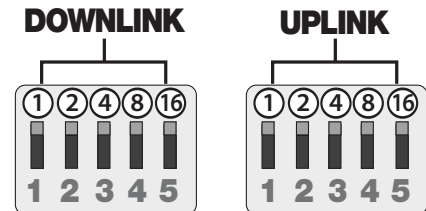

Additive combination effects:

- Switch 1 (1 dB) + Switch 2 (2 dB) = 3 dB attenuation
- Switch 1 (1 dB) + Switch 2 (2 dB) + Switch 3 (4 dB) = 7 dB attenuation
- Switch 1 (1 dB) + Switch 2 (2 dB) + Switch 3 (4 dB) + Switch 4 (8 dB) = 15 dB attenuation
- Switch 1 (1 dB) + Switch 2 (2 dB) + Switch 3 (4 dB) + Switch 4 (8 dB) + Switch 5 (16 dB) = 31 dB attenuation

Configuration and Testing

A few practical examples:

- Turning all switches OFF = 0 dB attenuation (booster is at full gain).
- Turning ON switch #1 in a bank = 1 dB attenuation (booster maximum gain is reduced by 1 dB).
- Turning ON switches #1, 3, and 5 in a bank = 1+4+16 dB attenuation = 21 dB attenuation. For example, in an 80 dB booster, the selected channel is reduced to 59 dB (80 dB -21 dB).
- Turning ON all switches in a bank = 1+2+4+8+16 dB attenuation = 31 dB attenuation. For example, in an 80 dB booster, the selected channel is reduced to 49 dB (80 dB-31 dB).

When the booster is powered on, the green **Power** light should illuminate.

- If any of the bands are oscillating, the corresponding band lights will flash red and the corresponding band(s) will shut off.

Note: When the booster is turned on, the band lights will flash red and yellow for approximately 10 seconds.

Note: In general, the uplink and downlink DIP switches should be set identically but this is not always the case.

5.4 LED Conditions

This section will help you interpret the LED indicators on your Force5 2.0. But first, here are a few configuration and testing points to keep in mind:

- When choosing a location for the outside antenna, a minimum signal reading of -100 dB is needed. A signal in the -70 dB to -90 dB range is recommended for best performance. A signal stronger than -70 dB may cause the affected frequency bands to stop amplifying.
- The booster gain dials should be at maximum level unless the control light for a specific frequency band is flashing red or red-yellow. In either case, try increasing the antenna separation between the inside and outside antennas as much as possible first, and then restarting the booster.
- Avoid setting the gain below 35 dB, as this could cause the affected frequency band to stop amplifying.

LED INDICATIONS

LED Color	LED Condition	Resolution
Yellow	Solid	The frequency band is not in use. Eventually, the band will enter sleep mode. When the light is off, it means things are normal, and that the band is active.
Yellow	Flashing	The Automatic Gain Control (AGC) is self-adjusting. This occurs during normal operation.
Red	Flashing	The booster is receiving too much signal. Can cause the affected band to automatically turn off. If this happens: <ol style="list-style-type: none">1. For kits using an OMNI outside antenna, relocate the outside antenna to a location where the signal is weaker.2. For kits using a YAGI outside antenna, turn the antenna in short increments away from the signal source.3. Increase the separation between antennas (more vertical separation works best).4. Add an inline attenuator to the cable connected to the Outside port on the booster.
Red	Solid	The associated frequency band is off. If the red light flashes for a long time (caused by too much signal), and then turns solid red, it means the associated frequency band has been turned off. This will happen if the gain dial for that frequency band has been turned all the way down.
Yellow/ Red	Flashes alternating colors	Self-oscillation has been prevented. Try this: <ol style="list-style-type: none">1. Increase the separation between the inside and outside antennas. If your booster kit uses two directional antennas (example: outside Yagi antenna and inside panel antenna), ensure that they are facing away from each other.2. If the condition continues, lower the dB gain setting in small increments until the light turns off or flashes yellow.

Refer to your Sentry Monitoring Software for more information about LED codes. Meanwhile, if you have any questions during setup, please reach out to our U.S.-based support technicians:

Call: 1-888-365-6283

Email: support@surecall.com

5.5 Testing & Troubleshooting

Once the booster is powered on (and no Warning lights are on), walk around the area to assess the voice and/or data signal in representative variety of locations. Refine the antenna locations and/or gain levels as needed, and then complete the permanent installation when you are confident the system will perform well.

A few tips and some perspective:

- It's not realistic to expect full reception everywhere in the building.
- As a general rule, increasing gain by 6 dB doubles the coverage distance of the interior antennas. Start at the lowest gain and increase gradually as needed.
- If one or more red Warning lights comes on, it indicates there is oscillation in that band and adjustments are needed.
- If you can't get the coverage reasonably well-balanced, you may need to install an additional interior antenna and/or a different type of interior antenna and/or relocate interior antennas.

Sentry Configuration

CHAPTER 6: SENTRY CONFIGURATION

Sentry Software Introduction

SureCall's Sentry is a revolutionary advancement in signal-booster management. It aids in the installation, optimization, and ongoing management of your Force5 2.0 BDA. It provides installers with tools for seamless system configurations, and it helps pinpoint malfunctions due to unforeseen changes in the amplifier landscape, such as new towers or repeater systems. Sentry also notifies installers or end users about various parameters via email. Features include:

- Quick notification about booster changes and over-power situations.
- Allows offsite monitoring and adjustments related to booster performance, such as uplink, downlink or bands.
- Helps optimize installations by monitoring and identifying the strongest signal strength available.

6.1 Software Installation

To install and configure the server, follow these steps:

- Get the SureCall Sentry software from your device supplier, or download the Windows software here: <http://www.surecall.com/product/Sentry.html>.
- Install the software using the steps outlined below.
- Configure the server to a static IP or public IP address.
- In order to function on the network correctly, the server and the Force5 2.0 device must be (a) on the same Local Area Network, or (b) the server must be the front end to the device.
- Use appropriate security software for safe and reliable operation when connected to a network.
- All device and user information will be stored on the computer.

Double-click [ServerSentrySetup\(V1.5\).exe](#) to start the installation, which takes you to Welcome screen.

Note: To avoid install glitches, we recommend you close all other Windows programs running on your computer before proceeding.

After you have shut down other programs, click Next, which will take you to the User Information screen shown below. This is where you'll enter user information. It may be you as the installer, or you may be setting this up for someone else who will be monitoring the system on an ongoing basis.

6.2 Hardware Installation

Once the Sentry software is installed, you can proceed to connect and configure the Force5 2.0 BDA.

- Connect the USB cable (provided) to the Booster's USB port then connect the other end of the USB cable to the USB port on your computer. The USB is only needed for configuration and may be disconnected once complete.

Sentry Configuration

- Connect an Ethernet cable to the booster's WAN port and connect the other end to your router.
- Once the connections are made, power on the Force5 2.0 BDA.
- Start the Sentry client application software. You will see the screens below:

6.3 User Registration

You'll need to register an account. Connect your computer to the network. A secure LAN connection is important because it will allow the computer to "see" the device on the network. Fill in the User Registration form and choose a user name, password, email and user phone. Once completed, click the Register button.

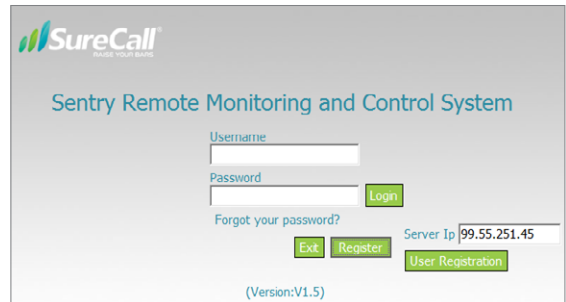

Click Register and you'll see the following screen, prompting you to enter the local Server IP address.

Enter SureCall's server IP: 99.55.251.45 in the Registration Window.

Enter a User Name, Password, E-mail, and User Phone in the fields provided. Then click Register to proceed. You will see the Login screen again, as shown in the next screen.

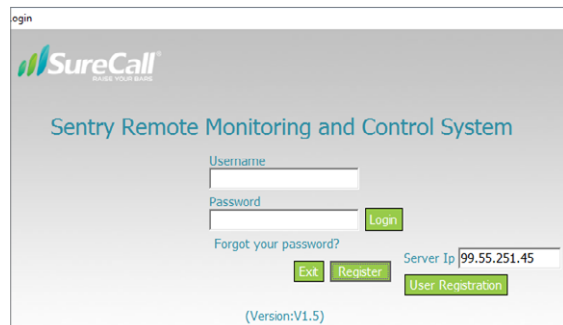

In the fields provided, enter the Username and Password that you registered on the system. This will enable you to proceed to device configuration, as explained in the steps below:

Sentry Configuration

6.4 Device Registration

Connect the device to the networked client computer with a USB cable as described in the previous section. Make sure the server is also linked to the computer. Select a serial port and click Open, as shown in the Add Booster screen below.

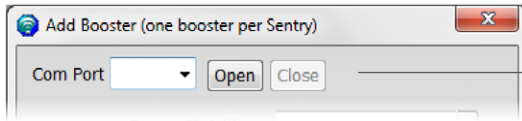

Complete device registration as described below:

- Click Refresh to query device parameters
- Enter a name in the Booster Name field
- Enter the location in the Location Address field (optional)
- Click Add to register the device on the server
- Keep in mind that only the registered user is authorized to see/operate the added device.

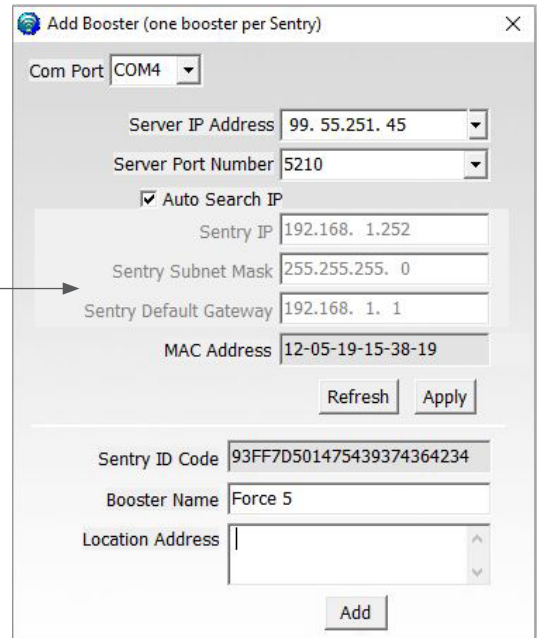
A screenshot of the 'Add Booster (one booster per Sentry)' dialog box. The 'Com Port' dropdown is set to 'COM4'. The 'Server IP Address' is '99.55.251.45' and the 'Server Port Number' is '5210'. The 'Auto Search IP' checkbox is checked. The 'Sentry IP' is '192.168.1.252', 'Sentry Subnet Mask' is '255.255.255.0', and 'Sentry Default Gateway' is '192.168.1.1'. The 'MAC Address' is '12-05-19-15-38-19'. There are 'Refresh' and 'Apply' buttons. The 'Sentry ID Code' is '93FF7D501475439374364234', 'Booster Name' is 'Force 5', and 'Location Address' is empty. There is an 'Add' button at the bottom.

6.5 Device Configuration

Using the same screen as before, configure the device according to the steps below.

- Select a serial port and click Open.
- Click Refresh to query device parameters.
- Click on the drop-down menu and select a server IP address and port number to make sure the device can be connected to the server.
- Dynamic IP is available by checking Auto Search IP function, OR...
- ...OR enter IP parameters manually, if the device needs a static IP.
- Click Apply to finish the configuration.

The following summary screen appears if the booster connects to the server successfully:

Add Booster

Force-5

Type: Force5 Name: Force-5 Address: Address

Band	Channel	Attenuation	Manual Attenuation	Automatic Gain Control Attenuation	Gain	Output Power	Outside Signal Strength	Uplink/Downlink Status	Band On/Off	Over Power	Oscillation	Over Attenuation
LTE-A	Uplink 698-716M	0 dB	0 dB	0 dB	64 dB	-20 dBm		Active	ON	Normal	Normal	Normal
	Downlink 728-746M	0 dB	0 dB	0 dB	64 dB		-75 dBm	ON	ON	Normal	Normal	Normal
LTE-V	Uplink 776-787M	0 dB	0 dB	0 dB	64 dB	-20 dBm		Active	ON	Normal	Normal	Normal
	Downlink 746-757M	0 dB	0 dB	0 dB	64 dB		-75 dBm	ON	ON	Normal	Normal	Normal
Cellular	Uplink 824-849M	0 dB	0 dB	0 dB	65 dB	-15 dBm		Active	ON	Normal	Normal	Normal
	Downlink 869-894M	0 dB	0 dB	0 dB	65 dB		-75 dBm	ON	ON	Normal	Normal	Normal
PCS	Uplink 1850-1915M	0 dB	0 dB	13 dB	59 dB	-20 dBm		Active	ON	Normal	Normal	Normal
	Downlink 1930-1995M	0 dB	0 dB	4 dB	68 dB		-63 dBm	ON	ON	Normal	Normal	Normal
AWS	Uplink 1710-1755M	0 dB	0 dB	3 dB	68 dB	-17 dBm		Active	ON	Normal	Normal	Normal
	Downlink 2110-2155M	0 dB	0 dB	0 dB	71 dB		-67 dBm	ON	ON	Normal	Normal	Normal

Refresh Apply Sentry Software Version SC ME1-MONITOR V1.6 Connection Status Normal

Column Definitions:

- **Attenuation:** Manually adjusted attenuation via software.
- **Manual Attenuation:** Manually adjusted attenuation using controls on the device.
- **Automatic Gain Control:** Automatically adjusted attenuation from excessive signal or close indoor/outdoor antenna proximity
- **Gain:** Current gain.
- **Output Power:** Current power.
- **Outside Signal Strength:** Strength of input signal.
- **Uplink/Downlink Status:** RF band status: Sleep, Active, OFF.
- **Over Power:** Over-power alert status: Red=Alert; Green=Normal.
- **Oscillation:** Oscillation-alert status: Red=Alert; Green=Normal.
- **Over Attenuation:** Manual over-attenuation status: Red=Alert; Green=Normal.



NOTE: BOTH THE MANUALLY ADJUSTED ATTENUATION BY DEVICE AND BY SOFTWARE CANNOT EXCEED 25 DB.

Sentry Operation

Modify Booster Information. To modify the booster information, right click to access a pop-up menu with the following additional options. Select Edit Booster Info to proceed.

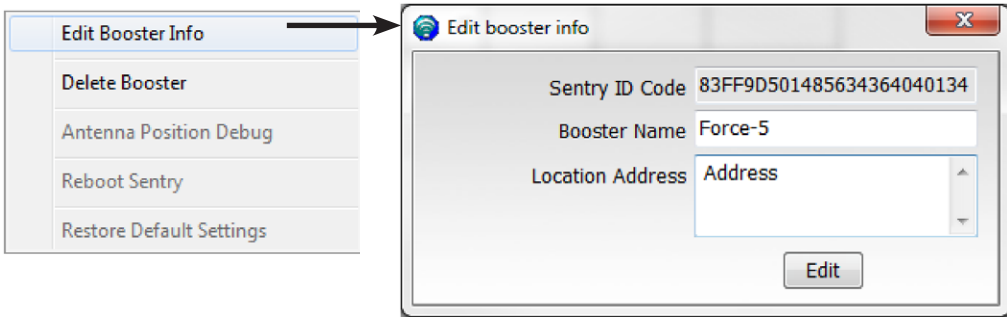

Delete Booster. To delete a booster, right click on the summary screen again to access a pop-up menu with additional options, and then select Delete Booster.

You will see a confirmation screen as shown below. Click Yes to proceed.

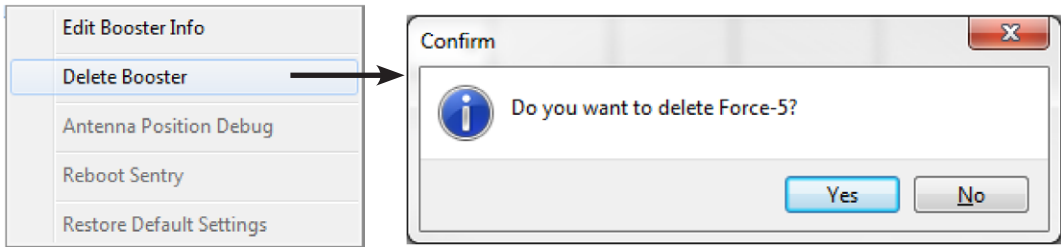

Password and E-mail Management: In the Tools pull-down menu, you can change your account information, including your password, or the e-mail address for status reports. Roll over the Accounts heading and click on Modify Password/E-mail to access this feature.

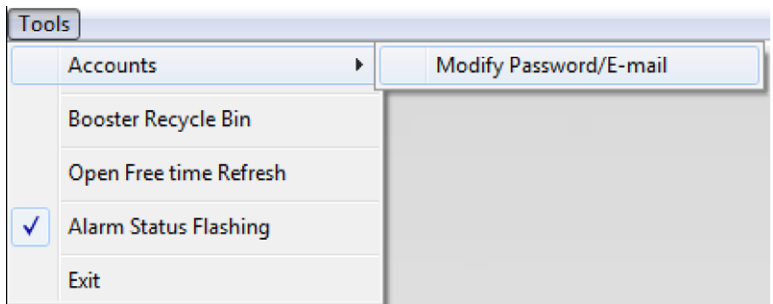

To modify your password, type in the requested information shown below and click on Modify.

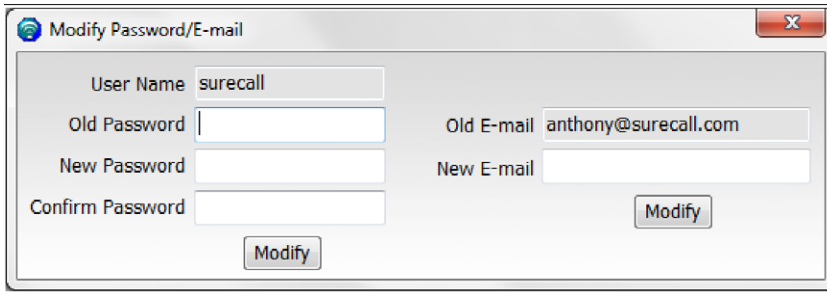

Modify Password/E-mail

User Name: surecall

Old Password: []

New Password: []

Confirm Password: []

Old E-mail: anthony@surecall.com

New E-mail: []

Modify

Modify

To change the e-mail address where alerts go, enter a new e-mail as shown above and click on Modify.



NOTE: IF YOU FORGET YOUR PASSWORD, CLICK FORGOT MY PASSWORD ON THE LOGIN PAGE. THE PASSWORD WILL BE SENT TO YOUR E-MAIL ADDRESS.

6.6 Using Antenna Placement Tool

Antenna Position Debug: The Antenna Position Debug Tool is used to test antenna RSSI values that will help you locate the optimal installation position of the outdoor antenna. Select your device, and right click to access a pop-up menu with additional options as shown below. Select Antenna Position Debug.



You will see the following Debug Tool screen:

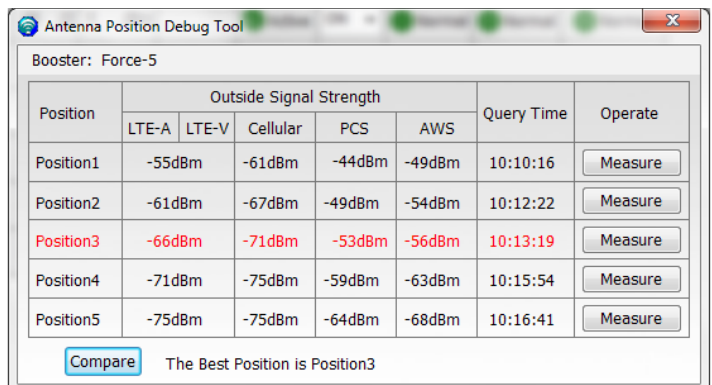

Antenna Position Debug Tool

Booster: Force-5

Position	Outside Signal Strength					Query Time	Operate
	LTE-A	LTE-V	Cellular	PCS	AWS		
Position1	-55dBm	-61dBm	-61dBm	-44dBm	-49dBm	10:10:16	Measure
Position2	-61dBm	-67dBm	-67dBm	-49dBm	-54dBm	10:12:22	Measure
Position3	-66dBm	-71dBm	-71dBm	-53dBm	-56dBm	10:13:19	Measure
Position4	-71dBm	-75dBm	-75dBm	-59dBm	-63dBm	10:15:54	Measure
Position5	-75dBm	-75dBm	-75dBm	-64dBm	-68dBm	10:16:41	Measure

Compare The Best Position is Position3

Sentry Operation

This tool will identify the optimum location for the outdoor antenna. To test for the best location, the booster and outside antenna must be connected by coax cable. Place the antenna in a position you'd like to test and click on the measure button.

The "Position" fields will automatically populate with the dB measurement from various locations by clicking on the measure button at each possible location. You can test up to 5 positions. Once you have entered all locations, click on the "Compare" button to find the best location. Keep in mind that a signal of less than -65 dB can over-power the booster.

6.7 Over Power Alert

If Red=ON, it means the input signal is too strong. Here are four possible solutions to try:

1. Relocate the outdoor antenna to a location where the signal is weaker. Or, If using a Yagi outside antenna, turn in small increments away from cell tower until Red alert is resolved.
2. Add an inline 5 dB or 10 dB attenuator (parts: SC-ATNR-5 and SC-ATNR-10) to the cable coming into the booster.
3. Lower the dB gain in small increments on the Sentry booster dashboard under the Attenuation column until the Over Power alert is resolved.
4. Manually adjust the attenuation or turn off a single band to mitigate oscillation and over-power issues.



ATTENUATION THROUGH CLIENT SOFTWARE IS
CUMULATIVE WITH THAT OF DIP SWITCHES.

Email Alerts Email alerts will be sent in the event of booster overpowering, over-attenuation, or if oscillation is detected.

Sentry Remote Monitoring and Control System(V1.5)

Tools

Add Booster
Type: Force5 Name: Force 5 Address:

Force 5

Band	Channel	Attenuation	Manual Attenuation	Automatic Gain Control Attenuation	Gain	Output Power	Outside Signal Strength	Uplink/Downlink Status	Band On/Off	Over Power	Oscillation	Over Attenuation
LTE-A	Uplink 698-716M	<input type="text" value="0"/> dB	<input type="text" value="0"/> dB	<input type="text" value="0"/> dB	64 dB	-25 dBm		● Active	ON ▾	● Normal	● Normal	● Normal
	Downlink 728-746M	<input type="text" value="0"/> dB	<input type="text" value="0"/> dB	<input type="text" value="0"/> dB	64 dB		-78 dBm	● ON	ON ▾	● Normal	● Normal	● Normal
LTE-V	Uplink 776-787M	<input type="text" value="0"/> dB	<input type="text" value="0"/> dB	<input type="text" value="0"/> dB	64 dB	-24 dBm		● Active	ON ▾	● Normal	● Normal	● Normal
	Downlink 716-757M	<input type="text" value="0"/> dB	<input type="text" value="0"/> dB	<input type="text" value="0"/> dB	64 dB		-78 dBm	● ON	ON ▾	● Normal	● Normal	● Normal
Cellular	Uplink 824-849M	<input type="text" value="0"/> dB	<input type="text" value="0"/> dB	<input type="text" value="0"/> dB	65 dB	-15 dBm		● Sleep	ON ▾	● Normal	● Normal	● Normal
	Downlink 869-894M	<input type="text" value="0"/> dB	<input type="text" value="0"/> dB	<input type="text" value="0"/> dB	65 dB		-82 dBm	● ON	ON ▾	● Normal	● Normal	● Normal
PCS	Uplink 1850-1915M	<input type="text" value="0"/> dB	<input type="text" value="0"/> dB	<input type="text" value="0"/> dB	72 dB	-22 dBm		● Active	ON ▾	● Normal	● Normal	● Normal
	Downlink 1930-1995M	<input type="text" value="0"/> dB	<input type="text" value="0"/> dB	<input type="text" value="0"/> dB	72 dB		-80 dBm	● ON	ON ▾	● Normal	● Normal	● Normal
AWS	Uplink 1710-1755M	<input type="text" value="0"/> dB	<input type="text" value="0"/> dB	<input type="text" value="0"/> dB	71 dB	-19 dBm		● Sleep	ON ▾	● Normal	● Normal	● Normal
	Downlink 2110-2155M	<input type="text" value="0"/> dB	<input type="text" value="0"/> dB	<input type="text" value="0"/> dB	71 dB		-83 dBm	● ON	ON ▾	● Normal	● Normal	● Normal

Refresh
Apply
Sentry Software Version SC ME1-MONITOR V1.9
Connection Status ● Normal

Total Data: 1 Data Sent: 1 Data Received: 1

Server IP:99.55.251.45 UserName:mark LoginTime:2016-09-14 08:48:32

Sentry Dashboard

From the dashboard above you can manually adjust the attenuation dB to resolve problems with oscillation and overpowering issues. You can also turn off individual bands.

ATTENUATION CAN BE LOWERED TO A MAXIMUM OF 30 OR 31 DB, DEPENDING ON THE BOOSTER MODEL AND A MAX OF 25 DB THROUGH SENTRY SOFTWARE.

Specifications

CHAPTER 7: SPECIFICATIONS

Force5 2.0 Industrial Specifications	
Uplink Frequency Range (MHz):	698–716 / 776–787 / 824–849 / 1850–1915 / 1710–1755 (G Block Included)
Downlink Frequency Range (MHz):	728–746 / 746–757 / 869–894 / 1930–1995 / 2110–2155 (G Block Included)
Supported Standards:	CDMA, WCDMA, GSM, EDGE, HSPA+, EVDO, LTE and all cellular standards
Input / Output Impedance:	50 Ω
Maximum Gain:	80 dB
Noise Figure:	5 dB
VSWR:	≤ 2.0
AC Input / Output:	Input AC 110 V, 60 Hz / Output DC 19 V
Maximum Output Power:	3 Watt EIRP
Cable:	SC-400 (not provided)
RF Connectors:	N Female (both)
Power Consumption:	<65W
Operation Temperature:	-4° F to +158° F
Dimensions:	14.5 x 11 x 3.5 inches
Weight:	19.5 lbs
IC:	7784A-FORCE5S

7.1 Suggested Kitting Options

Component	Product Number / Description / Note	Gain / Loss				
		LTE-A	LTE-V	Cellular 800 MHz	PCS 1900 MHz	AWS 1700 / 2100 MHz
Outdoor Antenna	SC-288W: Omni / N connector	3 dBi	3 dBi	3 dBi	4 dBi	4 / 4 dBi
	SC-230W: Yagi / N connector	10 dBi	10 dBi	10 dBi	10 dBi	10 / 10 dBi
Outdoor Cable	SC-400-30 NN, 30 ft	2.05 dB	2.05 dB	2.12 dB	2.83 dB	2.68 / 2.98 dB
Indoor Antenna	SC-222W: Dome	3 dBi	3 dBi	3 dBi	6 dBi	6 / 6 dBi
	SC-228W: Ultra Thin					
	SC-248W: Panel	7 dBi	7 dBi	7 dBi	10 dBi	10 / 10 dBi
Indoor Cable	SC-400-75 NN, 75 ft	4.22 dB	4.22 dB	4.41 dB	6.17 dB	5.8 / 6.54 dB

7.2 Installer Warning

WARNING: This is NOT a CONSUMER device.

It is designed for installation by an installer approved by an ISED licensee. You MUST have an ISED LICENCE or the express consent of an ISED licensee to operate this device.

AVERTISSEMENT : Ce produit N'EST PAS un appareil de CONSOMMATION.

Il est conçu pour être installé par un installateur approuvé par un titulaire de licence d'ISDE. Pour utiliser cet appareil, vous DEVEZ détenir une LICENCE d'ISDE ou avoir obtenu le consentement exprès d'un titulaire de licence autorisé par ISDE.

For details on the requirements specified in ISED CPC-2-1-05, visit: <http://www.ic.gc.ca/eic/site/smt-gst.nsf/eng/sf08942.html>

Pour plus de détails sur les exigences ISED CPC-2-1-05, reportez-vous au site: <http://www.ic.gc.ca/eic/site/smt-gst.nsf/eng/sf08942.html>

Important: Changes or modifications not expressly approved by the Surecall could void the user's authority to operate the equipment.

CHAPTER 8: WARRANTY

Activate your product warranty at www.surecall.com

For questions regarding your warranty, contact a SureCall representative at 1-888-365-6283 or email support@surecall.com.

8.1 Warranty Periods

Your warranty includes the following periods:

- **Three-Year Product Warranty:** SureCall products are covered under a three-year product warranty from the date of purchase. This protects the customer from any defects or problems the product may have that are solely the fault of SureCall. Incorrect installation or misuse will void this warranty. Upon the return of a defective product, SureCall will issue the customer a working replacement. All returned packages should contain all products distributed.
- **Five-Year Extended Product Warranty:** A five year warranty is available for purchase on any products sold by SureCall. A five-year warranty must be obtained at the time of purchase. This warranty adds an additional two years to the three year warranty we provide. All regulations still apply.

8.2 Three-Year Product Warranty

SureCall warrants its products for three years from the date of purchase against defects in workmanship and/or materials. Specifications are subject to change. The three-year warranty only applies to products meeting the latest FCC Certification Guidelines stated on 2/20/2013 and going into effect April 30, 2014. A two-year warranty applies to any products manufactured before May 1, 2014.

Products returned by customers must be in their original, un-modified condition, shipped in the original or protective packaging with proof-of-purchase documentation enclosed, and a Return Merchandise Authorization (RMA) number printed clearly on the outside of the shipping container.

Buyers may obtain an RMA number for warranty returns by calling the SureCall Return Department toll-free at 1-888-365-6283. Any returns received by SureCall without an RMA number clearly printed on the outside of the shipping container will be returned to sender. In order to receive full credit for signal boosters, all accessories originally included in the signal booster box must be returned with the signal booster. (The Buyer does not need to include accessories sold in addition to the signal booster, such as antennas or cables.)

This warranty does not apply to any product determined by SureCall to have been subjected to misuse, abuse, neglect, or mishandling that alters or damages the product's physical or electronic properties.

SureCall warrants to the Buyer that each of its products, when shipped, will be free from defects in material and workmanship, and will perform in full accordance with applicable specifications. The limit of liability under this warranty is, at SureCall's option, to repair or replace any product or part thereof which was purchased up to **THREE YEARS after May 1, 2014 or TWO YEARS for products purchased before May 1, 2014**, as determined by examination by SureCall, prove defective in material and/or workmanship. Warranty returns must first be authorized in writing by SureCall. Disassembly of any SureCall product by anyone other than an authorized representative of SureCall voids this warranty in its entirety. SureCall reserves the right to make changes in any of its products without incurring any obligation to make the same changes on previously delivered products.

As a condition to the warranties provided for herein, the Buyer will prepay the shipping charges for all products returned to SureCall for repair, and SureCall will pay the return shipping with the exception of products returned from outside the United States, in which case the Buyer will pay the shipping charges.

The Buyer will pay the cost of inspecting and testing any goods returned under the warranty or otherwise, which are found to

meet the applicable specifications or which are not defective or not covered by this warranty.

Products sold by SureCall shall not be considered defective or non-conforming to the Buyer's order if they satisfactorily fulfill the performance requirements that were published in the product specification literature, or in accordance with samples provided by SureCall. This warranty shall not apply to any products or parts thereof which have been subject to accident, negligence, alteration, abuse, or misuse. SureCall makes no warranty whatsoever in respect to accessories or parts not supplied by it.

8.3 Limitations of Warranty, Damages and Liability

EXCEPT AS EXPRESSLY SET FORTH HEREIN, THERE ARE NO WARRANTIES, CONDITIONS, GUARANTEES, OR REPRESENTATIONS AS TO MERCHANTABILITY, FITNESS FOR A PARTICULAR PURPOSE, OR OTHER WARRANTIES, CONDITIONS, GUARANTEES, OR REPRESENTATIONS, WHETHER EXPRESSED OR IMPLIED, IN LAW OR IN FACT, ORAL OR IN WRITING. SURECALL AGGREGATE LIABILITY IN DAMAGES OR OTHERWISE SHALL NOT EXCEED THE PAYMENT, IF ANY, RECEIVED BY CELLPHONE-MATE, INC. FOR THE UNIT OF PRODUCT OR SERVICE FURNISHED OR TO BE FURNISHED, AS THE CASE MAY BE, WHICH IS THE SUBJECT OF CLAIM OR DISPUTE. IN NO EVENT SHALL SURECALL BE LIABLE FOR INCIDENTAL, CONSEQUENTIAL, OR SPECIAL DAMAGES, HOWSOEVER CAUSED.

All matters regarding this warranty shall be interpreted in accordance with the laws of the State of California, and any controversy that cannot be settled directly shall be settled by arbitration in California in accordance with the rules then prevailing of the American Arbitration Association, and judgment upon the award rendered may be entered in any court having jurisdiction thereof. If one or more provisions provided herein are held to be invalid or unenforceable under applicable law, then such provision shall be ineffective and excluded to the extent of such invalidity or unenforceability without affecting in any way the remaining provisions hereof.

WARNING: E911 location information may not be provided or may be inaccurate for calls served BY USING THIS DEVICE.

48346 Milmont Drive
Fremont, California 94538, USA
888.365.6283
www.surecall.com

SureCall has made a good faith effort to ensure the accuracy of the information in this document and disclaims the implied warranties of merchantability and fitness for a particular purpose and makes no express warranties, except as may be stated in its written agreement with and for its customers. SureCall shall not be held liable to anyone for any indirect, special or consequential damages due to omissions or errors. The information and specifications in this document are subject to change without notice.

© 2017. All Rights Reserved. All trademarks and registered trademarks are the property of their respective owners.

SureCall, Inc
48346 Milmont Drive
Fremont, California 94538, USA
888.365.6283 | www.surecall.com