



AIR PURIFIERS AUSTRALIA  
Customer Support: 1300 030 367  
Email: [info@airpurifiersaus.com.au](mailto:info@airpurifiersaus.com.au)

The company reserves the rights to redesign  
this product and instruction without any advance notice.

## Smart Air Purifier

Instructions For Use



Viruses



Bacteria



Smoke



Odor



HCHO



PM2.5



Wifi

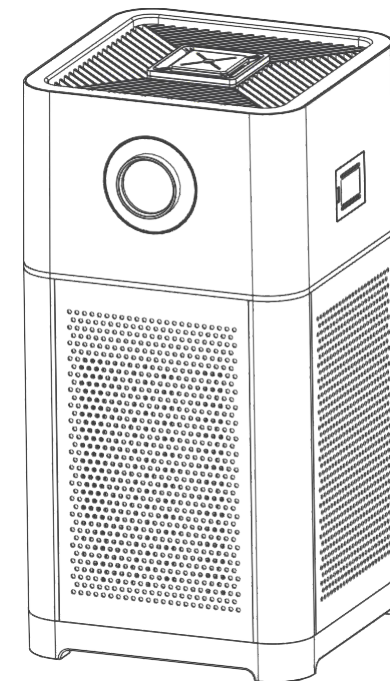

Model no. : AF-10

## Introduction to the product

This air purifier uses advanced purification technology, HEPA technology as the working principle, with high purification efficiency, purification speed, and other significant features.

Effective against domestic dust, animal hair and dander, smells and odors, pollen, array of airborne bacteria and viruses and harmful gasses.

Please read the “Caution / Warning” section to ensure safe use.

### Technical parameters

Voltage/Frequency	220V / 50Hz
Power	68W
CADR	600 m <sup>3</sup> /h
Air Volume	850 m <sup>3</sup> /h
Applicable Area	40-90 m <sup>2</sup>
Size	320 x 320 x 660 mm
Net Weight	7.05kg

Please read the instructions carefully before use. Please save the instructions for future reference.

## Caution / Warning

Keep away from water, (flammable) liquids to avoid the risk of electric shock or fire. Do not use water or (flammable) liquids to clean this device.

Before using the device for the first time, please ensure that the voltage indicated on the back or bottom of the device matches the local voltage.

Do not use the device if the plug, power cord, or the appliance is damaged. Damaged power cord must be replaced immediately by authorized personnel.

Service or repair must be performed by a qualified technician, in compliance with the manufacturer's instructions and following local safety norms.

If the power outlet is in poor condition, the device may become heated. Make sure the power cord is properly plugged in.

The device is not intended for use by young children without supervision.

This device is not a substitute for normal ventilation, daily vacuum cleaners, or kitchen ventilator.

Do not use the device in rooms with large temperature changes, as this may cause condensation inside of the device.

Do not use the device in wet or high temperature environments, such as bathrooms, toilets, or in the kitchen.

Do not clog the air in- and outlet, for example, do not place any obstacles in front of the in- or outlet.

## Caution / Warning

Place and use the device on a dry, stable, flat and horizontal plane.

Leave at least 20 cm of space on the rear and sides of the device. Leave at least 30 cm of space on the top of the device.

Do not place anything on top of the device or sit on it.

Do not place the device directly under the air conditioner to prevent condensate water drip into the purifier.

Before powering on the device, make sure all the filters are properly installed.

Only use the original filters designed specifically for this device, made by the manufacturer. Do not use filters from other brands and do not use other filter types.

Do not tap the device with hard objects (especially air in- and outlet), and do not insert fingers or other objects into the air in- and outlet.

Do not use the device while spraying insect repellents or in places filled with oil, flammable gasses, or chemical fumes.

Do not use the device near gas appliances, heating units, or stoves. Always unplug the power supply before and after cleaning the device.

To prevent interference, maintain a distance of at least 2 meters between the device and other appliances that use radio waves, such as televisions, radios, and radio control clocks.

The device does not remove carbon monoxide (CO) or helium (Rn) and can therefore not be used as a safety device in the event of combustion and hazardous chemical accidents

## About PM2.5 and air quality

### PM2.5

PM2.5 refers to particulate matter, also known as fine particulate matter, with an aerodynamic equivalent diameter of less than or equal to 2.5 microns in ambient air. The higher this value, the more serious the air pollution.

PM 2.5 is the detection limit of the air quality sensor (laser type).

The PM25 values will be visible on the display panel.

### Air quality indicators

Colour	Air quality
Blue	Excellent
Purple	Good
Red	Bad

The air quality indicator turns on automatically when the device is turned on and takes a short time to detect indoor quality.

Built-in air sensing measures air quality and automatically selects the appropriate colour for the air quality indicator, which is blue when the air is clean and changes from dark purple to red when air quality deteriorates.

The air quality indicator eventually stays on the colour corresponding to the accurate indoor air quality.

## Product overview

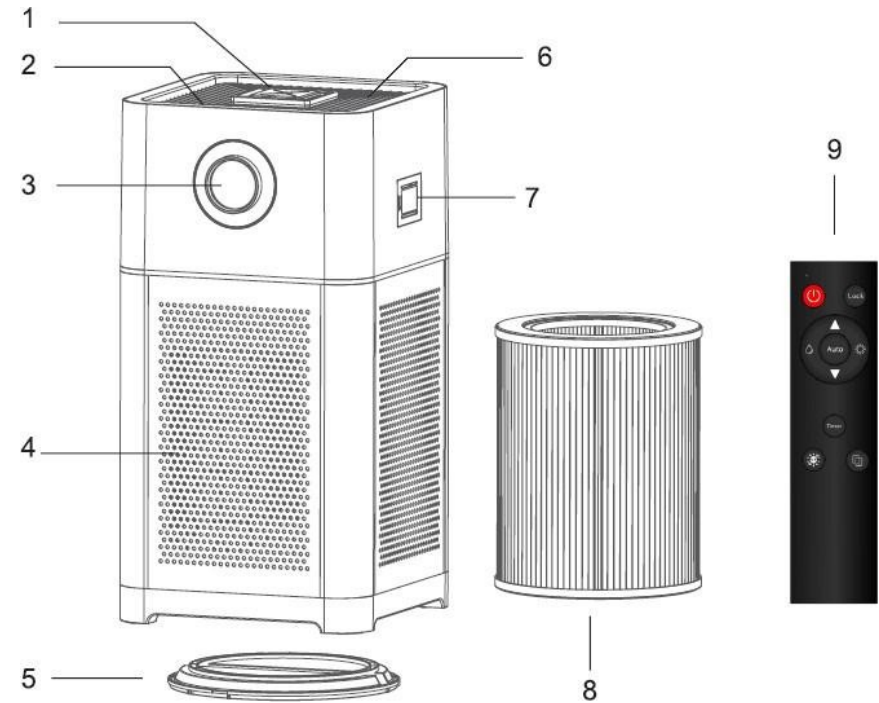



1. Humidification module
2. Touch key
3. Display panel
4. Air inlet
5. Filter bottom cover

6. Air outlet
7. Sensor cover
8. Filter
9. Remote control

## First time set-up

All filters are included inside this purifier, but it is important to remove the packaging of the filter before using the product. Follow the instructions below to remove all filters and remove their packaging, then put them back in the purifier.

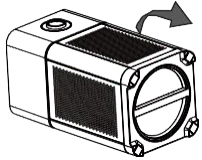
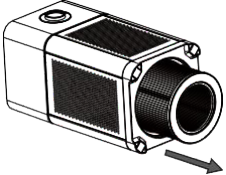
Ensure the filter is plugged into a correct position.

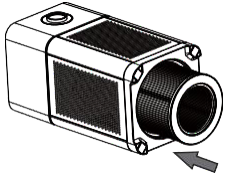
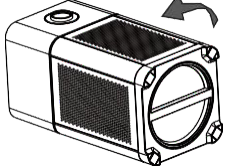
Screw the bottom cover clockwise to open.	
Remove the filter from the purifier.	
Remove the packaging material from the filter.	
Place the filter back into the purifier.	
Put the bottom cover of the filter back and screw counter clockwise to tighten.	

## How to use

1. Plug the power cord of the purifier into the socket.

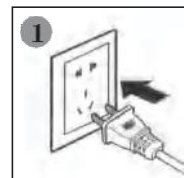

A beep is heard and all the lights come on at the same time. After that, the lights will go out again.

The air quality indicator will show the air quality at that time.

2. Press the button to turn on the purifier.

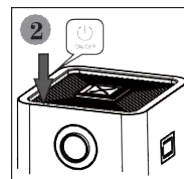



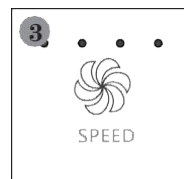



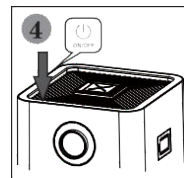

3. Fan speed indicator lights on.



4. Press and hold the ON/OFF button to turn off the purifier.



## Control keys usage

	ON/OFF	SPEED	TIMER	LOCK	HUMID	WIFI						
		Power ON/OFF function										
		The purifier has the following fan speed settings: <table border="1" data-bbox="434 427 958 520"> <tr> <td>Level 1 – Sleep</td> <td>Level 3 – Medium</td> </tr> <tr> <td>Level 2 – Slow</td> <td>Level 4 – High</td> </tr> <tr> <td colspan="2">Automatic – based on the sensor feedback</td> </tr> </table> The appropriate fan speed can be selected according to the requirement. The four lights on the control panel correspond to the setting and the display panel also displays the setting.					Level 1 – Sleep	Level 3 – Medium	Level 2 – Slow	Level 4 – High	Automatic – based on the sensor feedback	
	Level 1 – Sleep	Level 3 – Medium										
	Level 2 – Slow	Level 4 – High										
	Automatic – based on the sensor feedback											
	 Or Timer	The timer function can be used to set up the purifier running time. The device will automatically shut down once the settings are met. The display panel displays the timer settings. 1H, 4H, 8H, 12H, display time for the corresponding work time.										
		Function to control the humidification settings.										
	Press and hold Wi-Fi button 5 seconds to enter the set-up mode.											
	Long press for 3 seconds to turn on the childlock and the childlock light will be on. It is used to prevent children from misoperation. Long press for another 3 seconds to unlock.											
	Sleep mode (night mode) – extra quiet operation and dimmed operating panel. This is only available on the remote control.											
	The filter replacement key needs to be pressed 5 seconds after the filter is replaced. This is only available on the remote control. The symbol will be shown on the display when the filter needs to be changed.											

## Display and App



The display on the front of the device shows the following information:

- PM2.5 value
- Fan speed level
- Temperature
- Humidity
- Automatic mode
- Wi-Fi

The device can be controlled with the Tuya app, available in the Apple App Store and Google Play Store



## Humidity function (purified water)

Check the tank for liquid before turning on the Humidification function.

The purifier may be damaged if the function is turned on with sufficient liquid in the tank. (If the influence of atomization is poor, it needs to change the cotton swab regularly.)

1. The atomizer module is fixed in place with a cover. Gently lift it up to remove. When replace the small cotton swab, pull out the plastic bar and take out the cotton swab.

And insert the new cotton swab (packed with with remote) at the tube. Generally replace it every 6 months.

2. Fill the liquid tank to the marked level and place it back into the device.

3. Put the atomizer module back in to the purifier carefully. The registration mast and groove should be in alignment.

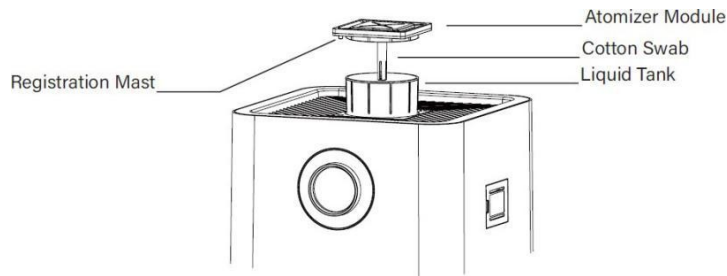

## Cleaning the purifier

While shifting the purifier, make sure that the power plug has been unplugged.

Unplug the power cord before cleaning the purifier.

Do not immerse this purifier in water or any other liquid.

Do not clean any part of the purifier with abrasive, corrosive or flammable cleaners such as bleach or alcohol.

Only pre-filters can be cleaned with water.

### Cleaning the purifier

Clean the purifier inside and outside regularly to prevent dust build-up.

1. Use a soft, dry cloth to wipe the dust off the body
2. Clean the air quality sensor inlet/air outlet with a soft dry cloth.

### Cleaning the air quality sensor

Clean the air quality sensor every 2 months to ensure that the purifier is operating at optimum performance levels. If the purifier is used in a dusty environment, clean it frequently.



1. Use a soft brush to clean the air quality sensor inlet or outlet.



2. Remove the protective cover of the air quality sensor.



3. Use slightly wet cotton swabs to clean the sensor, air inlet and outlet.

5. Replace the protective cover of the air quality sensor.

### Note:

While indoor humidity is very high, condensate may form on the sensors leading to poor air quality indication. In this case, you must clean the air quality sensor or use any manual speed setting.

## Replace the filter

The life of the filter depends on usage, the amount of time and polluted air and maintenance by the user. In environments with heavy air pollution, the life of the filter may be shorter than recommended.

If you remove the front panel to replace the filter when the purifier is on, all lights will turn off.

When the front panel is put back into the purifier, it starts running in its previous state. The replaceable filter is not washable or cleanable by the vacuum cleaner.

Place the filter in the correct position. Make sure that the side with the pull piece faces you.

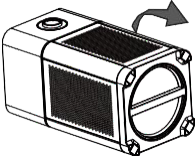
Turn off the purifier and unplug it.	
Screw the bottom cover clockwise to open.	

## Replace the filter

Remove the filter from the purifier.

Hold both sides of the discarded filter and carefully place it in the trash.

Note:

Avoid to touch the surface of discarded filters take care of hygiene rules. The filters contain airborne contaminants.

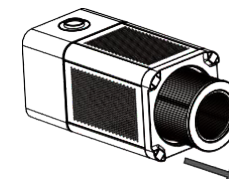

Remove the packaging material from the new filter.



Place the filter back into the purifier.

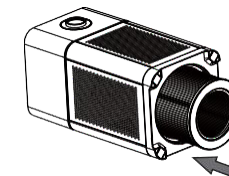

Put the bottom cover of the filter back and screw counter clockwise to tighten.

After the user replaces the filter, restart the purifier and touch the replacement filter key for 5 seconds. The filter timing is zeroed and the timing is restarted, the purifier is running correctly.

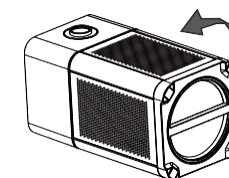



## Troubleshooting

This chapter summarizes common problems when you use the purifier.

Issue	Resolution
The replacement filter light on.	The filter is fully loaded. Replace the filter and reset the purifier.
There is no air discharge in the air outlet.	The purifier is not connected to the power supply, Plug the purifier into the power supply and start the purifier.
When sleep mode is on, the wind speed does not change.	In sleep mode, wind speed is set at a very low level.
The air flow from the outlet is significantly less than before.	You have not removed all packaging materials from the filter. Make sure you have removed all the packaging materials.
Even though the purifier has been running for a long time, the air quality has not improved significantly.	The air quality sensor is wet. Indoor humidity is too high, resulting in condensate. Make sure that the air quality sensor is clean and dry.
The color of the air quality indicator remains the same.	The air quality sensor is unclean. Clean the airquality sensor.
I am an allergy sufferer and need cleaner and fresher air.	You can change the sensitivity of the air quality sensor to allow the purifier to purify the air more fully and simply.
The noise of purifier is too loud.	You have not removed all packaging materials from the filter. Make sure you have removed all the packaging materials. or The wind speed is too high. You can change the fan speed to reduce the fan speed level.
I have replaced the filter, but the purifier still prompts you to replace the filter.	Press the button correctly to a filter reset.
I turned on the humidity function but there is no humidification.	There is not enough liquid in the tank, the cotton swab does not contact well with the atomizer.

## EM field / Warranty / Disposal

### Electromagnetic Field (EMF)

This device complies with all applicable standards and regulations regarding exposure to electromagnetic fields.

One of our main operating principle is to take all necessary healthy and safety measures for our products to comply with all applicable legal requirements, committed to the development, production and sale of products that do not pose any hazard to human health.

To prevent interference, maintain a distance of at least 2 meters between the device and other appliances that use radio waves, such as televisions, radios, and radio control clocks.

### Warranty

This product has a one year warranty from the time of purchase.

### Disposal

When disposing of a product, we recommend to dispose of it in an appropriate bin, which is good for the environment.