



# SWITCHBLADE 2



USER MANUAL  
MANUEL D'UTILISATION  
BENUTZER HANDBUCH  
MANUAL DEL USUARIO  
ユーザー・マニュアル



**CABRINHA**





# **WARNING**

DO NOT USE THIS PRODUCT UNLESS YOU HAVE READ AND UNDERSTAND THESE WARNINGS, CAUTIONS, AND INSTRUCTIONS WHICH ARE FOR YOUR SECURITY AND PROTECTION. THIS INFORMATION MAY BE SUBJECT TO CHANGE AT ANY TIME. FOR CURRENT UPDATES, PLEASE VISIT OUR WEBSITE AT: **[WWW.CABRINHAKITES.COM](http://WWW.CABRINHAKITES.COM)**

IF YOU ARE BELOW THE AGE OF 18, YOU SHOULD HAVE YOUR PARENT OR GUARDIAN READ THESE WARNINGS, CAUTIONS AND INSTRUCTIONS AND SHOULD NOT USE THIS PRODUCT UNLESS YOU ARE UNDER THE PROPER GUIDANCE AND SUPERVISION OF SUCH A PERSON.

The use of this product exposes the user to many unavoidable and unexpected risks, dangers and hazards. The suppliers of this product are not responsible for any damage to property or any personal injury caused by any active negligence of the suppliers or by any use, misuse, abuse or irresponsible use of this product by the user.

Kitesurfing is an extreme sport. Power kites and their lines and control equipment can be dangerous to flyers and to anyone in the vicinity of their use. Kitesurfing must be taken seriously and we recommend that, at least in the early stages of your use, you seek the guidance of professional instructors and experienced kiteboarders. Improper and/or unreasonable use of this kite may result in death or serious injury to any part of your body and to others. Do not use your kite near power lines, airports or streets, and keep your kite fly lines away from people and obstacles. Always fly in an open area and observe wind and weather conditions, particularly in circumstances where you may encounter offshore, onshore winds or strong winds. Do not attempt to use your kite on water until you are confident and comfortable with the use of a trainer kite on land. Spend time to become familiar with the operation of your kite and remember that you are responsible for its operation and for the security of those around you. As you learn the sport, work within your own limitations and do not exceed them. If you intend to use the kite on water, always use appropriate protective gears and flotation devices and do not attach yourself or tie yourself permanently to the kite lines. The kite is not intended for use as a flying device nor indeed is it intended as a means of flotation.

*...continues to next page*



continued from previous page...

# ! WARNING

## RECOMMENDED KITESURFING PRACTICE:

**KITESURFING is an extremely diverse sport, with many disciplines and ability levels. As with all sports, there can be certain inherent risks. The following contains key security points to remember when operating your Cabrinha kite.**

- Kitesurfing is a HAZARDOUS activity and the use of Kitesurfing equipment involves the risk of serious personal injury to any part of the user's body or death.
- Injuries are an INHERENT RISK of kitesurfing and the participation in kitesurfing implies the user's acceptance and express assumption of those risks.
- Children should always be under adult supervision.
- It is strongly recommended that beginners take lessons.
- ALWAYS inspect your equipment for signs of wear and tear each time before use, particularly all lines, canopy, bladders, screws and fittings.
- If any products are found to show signs of wear & tear these should be repaired or replaced immediately and before further use. If in doubt about any signs of wear & tear, please contact your local vendor. Contact details are available from [www.cabrinhakites.com](http://www.cabrinhakites.com)
- NEVER place yourself in a situation where breakage of any one of the various kitesurfing components would pose a risk to yourself or others, or make it impossible to return to the shore securely & unassisted.
- Make sure you use properly designed and manufactured parts from reputable suppliers.
- Take time to study the conditions including sea state, tides, currents, weather conditions and forecasts before you decide to go sailing. Beware of sailing in offshore or onshore winds.
- Familiarize yourself with any new location before venturing onto the water. Ask the locals to tell you about any hazards.
- Watch out for other beach users, especially swimmers and small children. Make sure you keep your board and rig under control at all times and that they don't get blown about on the beach or in the water.
- Always use appropriate protective gear and flotation devices. Wear the correct protective clothing for the conditions such as a wetsuit or a UV top. It is recommended to wear a helmet.
- Make sure someone knows where you've gone & when you are expected back – always sail with a buddy.
- Be aware of the conditions as they change. Always return to the beach if there is a significant change in the conditions. i.e. wind dropping or wind & waves increasing.
- As you learn the sport, work within your own limitations and do not exceed them.
- Do not alter, modify or change this product.
- This product is designed and manufactured only for kitesurfing on water or snow.
- Keep these warnings, cautions and instructions for future reference.

## SNOW USE GENERAL GUIDELINES

- 1) Always stay in control and be able to stop or avoid other people or objects
- 2) SNOWKITE: People downwind or down slope have right of way. It is your responsibility to avoid them
- 3) SNOWBOARD: People down slope have right of way. It is your responsibility to avoid them
- 4) You must not stop where you obstruct others or are not visible.
- 5) Whenever starting or merging with others look upwind/up hill and yield to others.
- 6) Always use devices to help prevent runaway equipment.
- 7) Observe any and all posted signs and warnings
- 8) Keep out of closed areas
- 9) SNOWBOARD: Prior to using any lift you must have the knowledge and ability to load, ride and unload safely.
- 10) Do not snowboard/snowkite when tired or under the influence of alcohol or drugs.
- 11) Snow terrain and snowboarding/snowkiting conditions vary constantly--watch out for and avoid any man made structures, trees, rocks, debris, variations in terrain or slopes, avalanche areas, crevasse, cliffs, power lines, water hazards, changes in snow surfaces or texture due to altitude and sun exposure, wind and weather changes, and any other conditions which could affect your ability to properly control your snowboard/snowkite.



# INDEX

---

- 2 Introduction
- 3 Important Information
- 4 Wind, Water, & Weather Conditions / Wind Range Chart
- 5 Know Your Ability Level / Kiteboarding Location
- 6 Important Information
- 7 Beach Etiquette

## KITE OVERVIEW & CONTROL SYSTEM

- 8 Switchblade 2 Overview

## SETUP

- 10 Sprint Inflation System
- 11 Inflating the Kite
- 12 Tips for Securing Your Kite  
Deflating the Kite
- 16 Attaching Control Lines

## HOW TO:

- 17 Area of Operation / Kite Positions, Zones & Power
- 19 Steering
- 20 Planning Your Launch
- 21 Launching & Landing with a Partner
- 23 Relaunching
- 24 Tuning The Kite
  
- 25 Repairs - Tears / Struts Bladders
- 27 Repairs - Leading Edge Bladders
  
- 29 Glossary

# SWITCHBLADE 2 USER MANUAL





# INTRODUCTION



## THANK YOU

for purchasing a Cabrinha kite and welcome to the sport of kiteboarding. As you may know, the excitement of Kiteboarding is attracting people of all ages from all corners of the globe. It's one of the most dynamic and fastest growing sports in the world.

**CAUTION:** It can also be overwhelming if not approached in an educated manner. That's why we have supplied this extensive user's manual. It will help to educate you about your new kite and about the ways in which to use it. It contains information regarding the setup, care and maintenance of your Switchblade kite. For information about operation of the kite including how to power up and de-power your kite you must refer to the manual supplied with your Cabrinha control system. Please note that only a Switchblade compatible control system will provide all of the security and performance functions associated with this bow kite. Consult [www.cabrinhakites.com](http://www.cabrinhakites.com) for a list of compatible control systems for use with this kite.

Please read this user's manual carefully and entirely before using this kite. This manual is not intended to replace proper kiteboarding instruction, but rather to supplement it. Do not attempt to kiteboard without appropriate instruction. It will make this sport more enjoyable, not only for yourself, but for those around you.





# IMPORTANT INFORMATION

## IMPORTANT INFORMATION

KITEBOARDING is an extremely diverse sport, with many disciplines and ability levels. As with all sports, there are certain inherent risks. The following contains key points to remember when operating your Cabrinha kite.

- Be familiar with the set up and use of the supplied security systems: OVERRIDE and the Harness Loop Quick Release systems.
- Make sure your control system is rigged and used according to the supplied instructions.
- Make sure your kite is compatible with the control system.
- Always use your Cabrinha kite with a security system.
- NEVER permanently attach yourself to this kite, the control bar, or lines.
- NEVER use this kite as a flying device.
- NEVER touch the kite lines while they are under tension; do not catch the kite using these lines.
- When inflated but not in use, secure your kite with sand or with something heavy and non-abrasive; the more weight the better (see "Kite Care" for more information). An inflatable power kite will still fly, even without a rider, so be mindful of those around you and secure your kite. Your kite may cause serious injury or death if it launches unexpectedly.
- Do not lend your gear to someone who has not been fully instructed on the use of inflatable kites. Other users should also read this user's manual and be proficient in all its points.
- Check your gear before use. Insure that your flying lines, security systems, kite, board, etc. are all rigged properly and are in working order.

## PROTECTIVE GEAR

We strongly recommend the use of the following protective gear:

- Helmet
- Life Jacket, Impact Vest, or Flotation Vest
- Neoprene Wet Suit
- Gloves
- Foot Protection
- Eye Protection
- Knife
- Sunscreen





# IMPORTANT INFORMATION

## WIND, WATER, & WEATHER CONDITIONS / WIND RANGE CHART

### WIND, WATER, AND WEATHER CONDITIONS

- Do not underestimate the power of the wind.
- Be aware of unpredictable and changing weather conditions.
- Avoid "offshore" or "onshore" wind conditions.
- Avoid strong, gusty wind.
- Be careful of wave conditions, especially when learning.
- Be educated about tides and rip currents.
- Be mindful of your ability level. Do not kiteboard if conditions are beyond your ability level.
- Be educated about air and water temperatures and wear appropriate protection against the elements.
- Do not use this product in thunderstorms.
- Consult an anemometer to determine wind speeds if necessary.
- Do not use an oversized kite. Consult your Wind Range Chart for the correct recommended size. Use your common sense. If in doubt about what kite size to use, choose smaller rather than bigger.
- Make certain that you are physically capable of operating the security Quick Release(QR) and Override™ devices provided with this kite. This kite and control system has been designed around a typical rider weight of 75kg.

Riders with a weight greater than 75kg may need to use more force to operate the QR than lighter riders. Increases in wind strength may also result in greater force being required to operate the QR. Be certain to seek the advice of a professional such as your Authorized Cabrinha Dealer about the performance of the security systems in relation to body weight.

### WIND RANGE CHART

This wind range chart is only to be used as a point of reference. It is based upon a rider who is approximately 170 lbs. (75 kg). Actual use may vary based on your body weight, ability level, water conditions, board size, and riding style. When choosing a kite size, please use your personal experience, common sense, and always check what other riders are using on the water for a size reference. Lighter riders should use a smaller kite and heavier riders may need a size larger. Be certain to seek the advice of a professional such as an instructor or Authorized Cabrinha Dealer before making your decision.

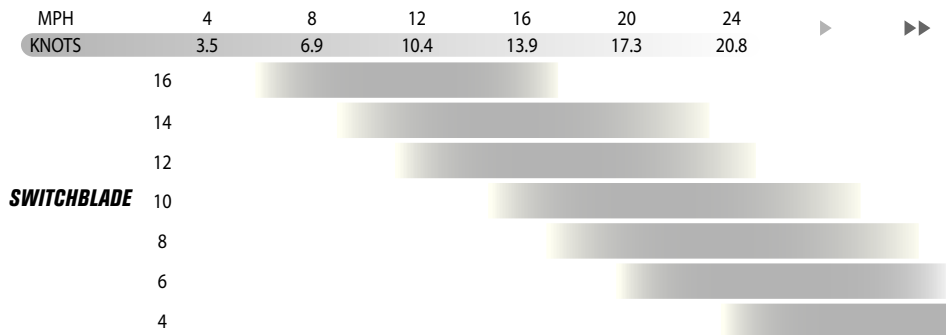

\* How to read: Gray = best suited for. Light Gray = usable. White = not recommended.







# IMPORTANT INFORMATION

## KNOW YOUR ABILITY LEVEL / KITEBOARDING LOCATION

### KNOW YOUR ABILITY LEVEL

- Do not attempt kiteboarding without appropriate instruction.
- Do not kite alone.
- Launch, land, and ride together with a partner or have someone on shore who can keep an eye on you.
- Make sure you are in good physical condition before using this product.
- Practice flying a small, traction kite or a “trainer kite” before flying this kite.
- The more time spent on the “trainer kite”, the faster you will learn.
- Make sure you are a proficient swimmer before using this product in or near the water.
- Make sure the wind and water conditions are within your ability level and that you have made the correct equipment choices.
- Never kiteboard further from shore than you are able to swim back.
- Always save a reserve of energy; end your kiteboarding session before you are exhausted.
- Make sure you’ve done your homework and that you know the security precautions of all aspects of the sport: rigging, launching, landing, flying, riding, kiting among other water users, self rescuing, etc.
- Understand your security systems before ever launching your kite.
- Understand the technique of self-rescue before using this product in or near the water.
- Never let someone who is not familiar with inflatable kites launch, catch, or use your kite. You will endanger them, as well as yourself and those around you.
- You are responsible for the proper operation of your kite.

### KITEBOARDING LOCATION

- Observe local laws and regulations regarding this product and the usage area.
- Talk to the local riders about the weather conditions and beach rules.
- Check your area thoroughly before launching your kite.
- Make sure you have considerable space in which to launch, land, and use this product.
- You should have at least 100 meters of space on both sides and downwind of you. Be especially aware of your downwind area.
- Be mindful and aware of the wind direction in relation to your launch area.
- Avoid areas with rocks and/or shallow or exposed reefs.
- Be mindful of tide changes. As water levels change, you may be exposed to new obstructions.
- Avoid launching, landing or using this product near power lines, telephone poles, trees, people, pets, buildings, automobiles, streets, sharp objects and airports.
- Avoid crowded beaches and waterways.
- Make sure your lines do not cross a walkway or passage.
- Do not let others walk between you and your kite.
- Be careful and mindful of other water users, including windsurfers, boaters, jet skiers, swimmers, floating objects, etc.
- Before launching, make sure you have scouted a backup landing area, in case you do not make it back to your launch spot.



# IMPORTANT INFORMATION

## KITE CARE

Due to the often extreme nature of kiteboarding, a thorough approach should be taken when caring for your kite and all its associated rigging, as well as your protective gear.

## PREPARING FOR YOUR SESSION

- Thoroughly check your protective equipment (helmet, etc.) to make sure it is in working order and in good condition.
- A frequent inspection of the kite and the control system should be made in order to identify punctures, tears, or abrasions in the canopy, struts, or security systems. It is also necessary to check the fly lines for wear and for unwanted knots, which may reduce the strength of the fly lines.
- Do not rig on asphalt, cement, gravel, or other abrasive surfaces; doing so may damage your equipment. It is best to rig on sand or grass. Damage done to your equipment by rigging on abrasive surfaces will not be covered under warranty.
- Do not rig among sharp objects that could tear the canopy or puncture the struts and leading edge bladder.
- Take care not to expose your flying lines to sharp objects that may wear through them.
- While setting up, secure your kite with sand or sand bags. Do not secure your kite with rocks or other sharp or abrasive objects that may damage your kite.

## BETWEEN SESSIONS

- Never leave an inflated kite unattended on the beach for a long period of time. Winds may shift or change and the kite may become unsecured and fly off.
- Do not leave an inflated kite (secured or not), directly exposed to the wind for any length of time. This allows the trailing edge to flutter excessively, which can damage the kite or tangle the bridles/control lines. If you must leave the kite exposed to the wind on the beach, place sufficient amounts of sand between each strut and near the trailing edge to minimize or stop the fluttering.
- Do not leave your kite exposed to sunlight for long periods of time. Between sessions, choose a shaded area to secure your kite. When not in use, stow away.

## PROPER STORAGE

- It is recommended to wash your kite with fresh water and dry thoroughly before rolling and storing.
- Do not roll up kite when wet.
- Clear the kite of sand or other foreign objects before stowing.
- Once it is clean and dry, stow your kite in the supplied bag in a clean, dry, cool place.
- Do not place heavy objects on the bag containing the kite.
- Do not leave your kite inflated in your car or car rack box; exposing the kite to extreme temperatures while inflated may damage the internal bladders.
- Wash your control system with fresh water from time to time by placing the entire control system (with lines wound onto the bar) into a bucket of fresh water and let it sit for 5 minutes. Allow to dry thoroughly before storing in a dry location.
- Once it is clean and dry, stow your control bar in the supplied bag in a clean, dry, cool place.





# BEACH ETIQUETTE

## BEACH ETIQUETTE

Here are some basic things to consider when sharing beaches and water accesses with other users:

### SAFETY

- Follow the instructions outlined in this manual.
- Follow the instructions and rules and regulations posted at the areas you use.
- Check with local kiteboarding associations and shops prior to launching in a new area. There may be local rules and regulations to follow which are not posted.
- Utilize common sense.
- Do not touch other people's gear, unless instructed to do so by the owner. Picking up their bars, kites, etc. may disrupt a setup ritual they have.
- Always secure your kite with sand or sand bags. An unmanned kite is dangerous.
- Never leave an inflated kite unattended. Winds may shift and cause the kite to become unsecured and fly off.

### SETTING UP

- Set up only the gear that you plan on using immediately. Deflate and put away your kites when not in use.
- Set up in an area where you have plenty of space.
- Set up in a manner conducive to having multiple users in the area.
- Roll up your lines when not in use.
- Always keep other beach and water access users in mind when launching, landing, and kiteboarding.
- Yield to other beach users. Be courteous and cooperative.
- Always be ready to lend assistance to other kiteboarders. The favor may be returned sooner than you think.





# KITE OVERVIEW

## Switchblade 2

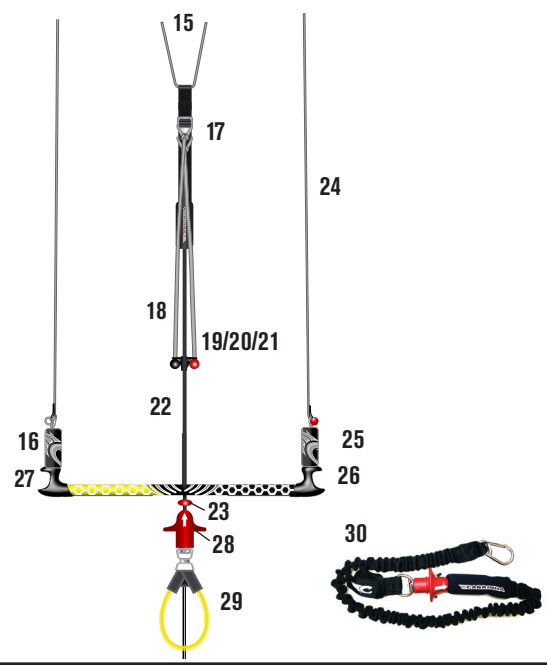
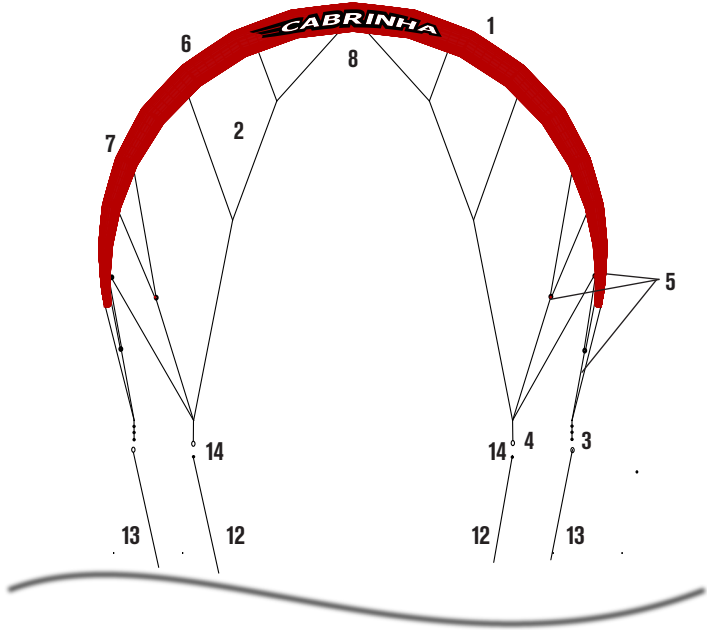

\*image not to scale





# KITE OVERVIEW

## Switchblade 2

### SWITCHBLADE 2 OVERVIEW - POWERDRIVE 121

1. 4-Line Kite Body
2. Bridle
3. Steering (Rear) Line Attachment Point
4. Depower (Front) Line Attachment Point
5. Pulleys (KS6SEBP)
6. Multi-Segmented Dacron Leading Edge
7. True Match 3-D Battens
8. Airlock High Volume Valve (KS6ALVA)
9. SPRINT Single point inflation valves
10. SPRINT Air distribution tubes (KS6STCOLA)
11. SPRINT Air clips (KS6PINCHC)
12. Front Flying Line (KS6RFL)
13. Rear Flying Lines (KS6RFL)
14. Line Connectors (FRONT/REAR) (KS6RECAST)
15. Front Leader Lines
16. Flagging Ring
17. Centerline Adjustment Strap (KS6OVUPKT)
18. Power/Depower Extensions
19. Override Unit
20. Override Sleeve (KS6ORT2)
21. Tension Ring (KS6ORTRING)
22. Depower Main Line (KS6SQCLDL)
23. Leash Interface Ball (KS6SPLIB)
24. Rear Leaders (KA6CCBL)
25. Bar Floats (KS6CBBF)
26. Line Managers
27. Multi-Function Bar Ends (KS6CBEF)
28. Harness Loop Quick Release
29. Harness Loop (KS6HL)
30. Bypass Leash (KS6BPLS)

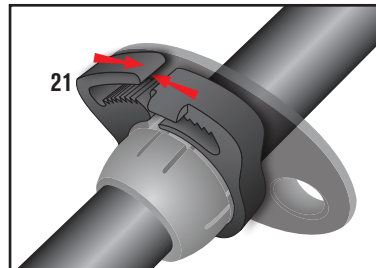
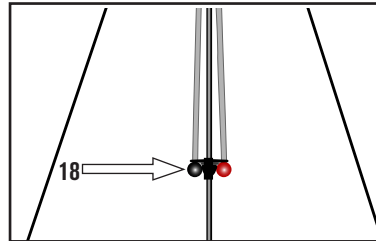



# SETUP

## INFLATING THE KITE

### SPRINT INFLATION SYSTEM

The Sprint inflation system is a simple to use feature to quickly inflate your kite to an even pressure. The Sprint system uses a single inflation point to connect your high volume, two way Cabrinha pump. As you pump your kite with air, all struts and your leading edge inflate quickly and simultaneously to the desired pressure. The supplied leash pump and threaded valve connection keeps your kite under control even when pumping up directly in the wind.

Once the kite is pumped you can choose to clip off the air to the struts. This way if you damage a strut while in use, the rest of the kite will maintain its pressure. At the end of the session you can choose to deflate your kite completely by disengaging the strut clips.

You can also keep your struts inflated and put your kite away rolled up so that the next session will take just minutes to set up.

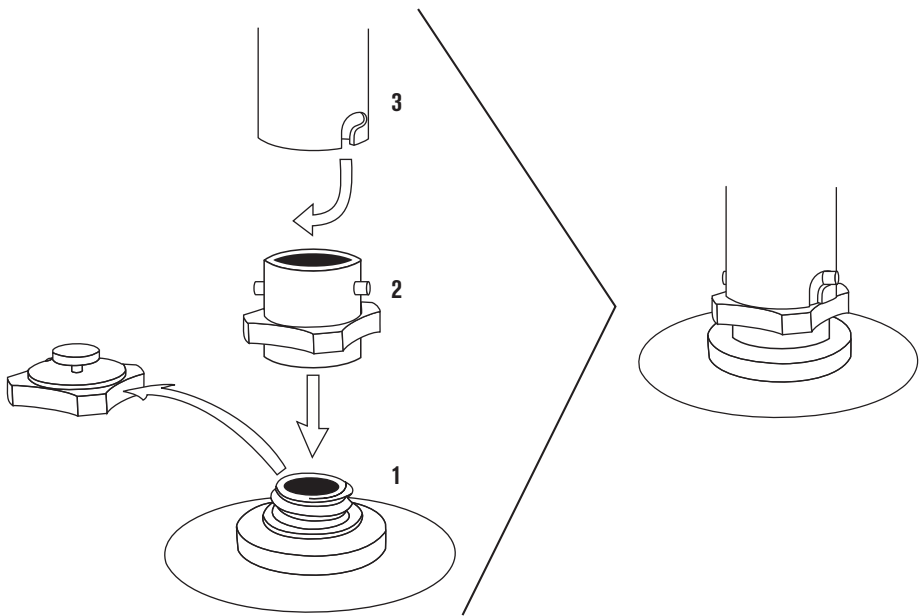
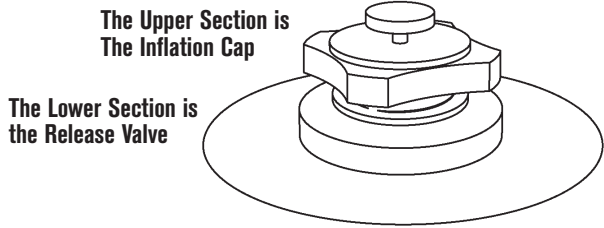



# SETUP

## INFLATING THE KITE

### INFLATION BASICS

See the section on Kite Care before inflating your kite.

- Unroll your kite with the struts facing up.
- Make sure your back is to the wind and that the leading edge of the kite is closest to your body. Secure the kite with sand or sand bags to keep it from flapping in the wind.
- Use the supplied pump leash to connect the pump to the kite. This will free your hands to pump the kite.
- Open the inflation cap by turning it counter-clockwise.
- Make sure that the release valve is seated firmly by turning clockwise. Do not over tighten the release valve when the kite is not inflated. Doing so may twist and damage the bladder. The valve base is held in place by a Velcro disc
- Attach the pump using the supplied Cabrinha adapter (or use a standard nozzle). To attach the adapter, remove the adapter from retaining strap. Thread the adapter on to the upper section of the Airlock™. Attach the hose and pump the kite. Be sure to secure the adapter before launching the kite.
- Open all of the Air Clips to allow air to flow from the LE into the struts.
- When inflating, hold the pump with both hands and provide even pressure to the handle. This will help maintain the life of the Pump.
- Confirm that the corners of each strut under the leading edge are able to fully inflate. Lightly push air around in the bladders until the corners are free and correctly lined up.
- It is common that the LE will inflate before the struts. If a strut is not inflating, make sure that the air clip is open and the air tube is not pinched or damaged.
- When the leading edge is fully inflated, remove pump hose and screw the inflation cap back on. Lightly turn/tighten until inflation cap is firmly secured.
- Tighten the lower release valve.
- Do not under-inflate or over-inflate the kite. Proper inflation will make it difficult but not impossible to bend the ends of the kite in. If it is very easy to bend the wing tips in, the leading edge is under-inflated. Your kite should be firm enough that while on its back, the wing tips should extend into the air and the kite should retain its bowed shape. If the leading edge is under-inflated, it may cause poor performance and re-launching problems. NOTE: The pumps are rated to 1bar of pressure, however due to wear and tear; pumps can fail at a much lower pressure.
- It is recommended that you isolate the air in your struts. After the kite is inflated, close the clips on the air distribution tubes.
- Once the kite is properly inflated, turn the kite over and secure with sand. (see SETUP TIPS ON SECURING YOUR KITE)



**Properly-Inflated Kite**



**Under-Inflated Kite**





# SETUP

## SECURING YOUR KITE / DEFLATING THE LEADING EDGE

### TIPS FOR SECURING YOUR KITE

- Never leave an inflated kite unattended on the beach for a long period of time. Winds may shift or change and the kite may become unsecured and fly off.
- Always secure your kite with sand or sand bags, using more weight than you think you need. An unmanned kite is dangerous.
- Never secure your kite with rocks or sharp objects (including your board); they will compromise the life of the kite. If you do not have a sandy beach launch, consider sand bags.
- Do not leave an inflated kite (secured or not), directly exposed to the wind for any length of time. This allows the trailing edge to flutter excessively, which can damage the kite or tangle the control lines. If you must leave the kite exposed to the wind on the beach, place sufficient amounts of sand between each strut and near the trailing edge to minimize or stop the fluttering. Also, if possible, leave the kite in a shaded area.
- Keep in mind other beach users and make sure your kite and lines will not be a danger to others.
- Wind your lines onto the bar when you are not kiting. This will keep the beach free of lines and will prevent other beach users from becoming tangled in your equipment.



### DEFLATING THE KITE

The kite may be deflated completely or partially for your convenience. To deflate the Leading Edge, you must unscrew the release valve and not the inflation cap. The release valve is the lower portion of the AIRLOCK. After deflating, clear the valve of any sand or debris; then seal the valve before stowing kite to prevent debris from getting inside internal bladder. To deflate the struts, unclip the air clips at each strut. This will allow air to flow through the leading edge and out of the airlock.

Important: **CAUTION**

When closing valve on deflated kite, hold bladder in place to prevent twisting the bladder. Do not over tighten valve when kite is deflated. You may tighten it further when kite is partially inflated again.

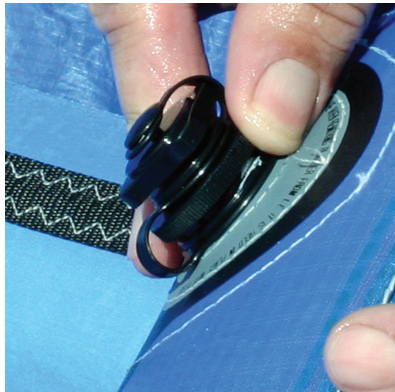
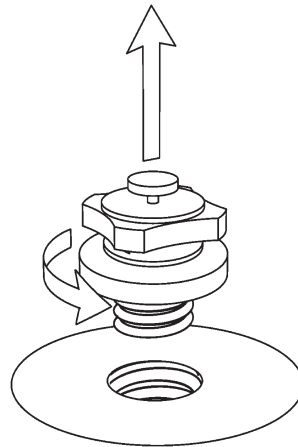





# SETUP

## PAUSE!



FOR SETUP OF YOUR CABRINHA CONTROL SYSTEM, REFER TO YOUR SUPPLIED CONTROL SYSTEM MANUAL.

IF YOU ARE UNSURE AS TO WHICH CONTROL SYSTEMS ARE COMPATIBLE WITH THIS KITE, PLEASE REFER TO THE KITE/ CONTROL SYSTEM COMPATIBILITY CHART AND CONTROL SYSTEM USER MANUALS AVAILABLE ONLINE AT [WWW.CABRINHAKITES.COM](http://WWW.CABRINHAKITES.COM).

WHEN YOU ARE READY TO CONNECT YOUR CONTROL SYSTEM TO THIS KITE, RESUME READING ON PAGE 14.





# SETUP

## CONNECT AND LAUNCH - ATTACHING CONTROL LINES

### ATTACHING CONTROL LINES

Once you have completed SET UP 1 & 2, you are ready to connect your control system to your inflated kite.

- With your lines laid out, carry the kite to the end of the flying lines farthest from your control bar. Make sure the leading edge is facing into the wind.
- Secure the kite with sand or sand bags. Do not secure kite with anything sharp or abrasive.
- You will notice four connection bridles on your kite (two bridles on each wingtip. There are three knots on each rear bridle and one larks head loop on each front bridle. Utilize the middle knot on the rear bridle; the other knots are there for tuning purposes. (Fig. 1)
- Slip the knot on your yellow de-power (center) line into the larks head loop on the yellow bridle on the left wing tip of the kite. Give the knot a tug to secure.
- Using a larks head knot, attach your yellow steering (outside) line to the yellow bridle on the left wing tip of the kite. Give the knot a tug to secure.
- Slip the knot on your black de-power (center) line into the larks head loop on the black bridle on the right wing tip of the kite. Give the knot a tug to secure.
- Using a larks head knot, attach your black steering (outside) line to the black bridle on the right wing tip of the kite. Give the knot a tug to secure.

CAUTION: See "Kite Overview" as reference.

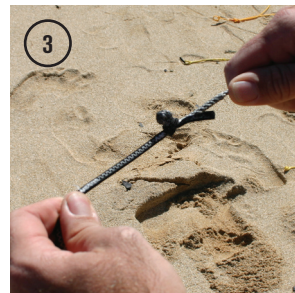
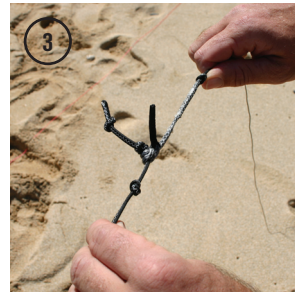



# KITEBOARDING BASICS

## AREA OF OPERATION / KITE POSITIONS, ZONES & POWER

### AREA OF OPERATION

This is the 100 meters of area to each side and downwind of the rider. Do not launch your kite if you do not have this distance between yourself and other people, or obstructions.

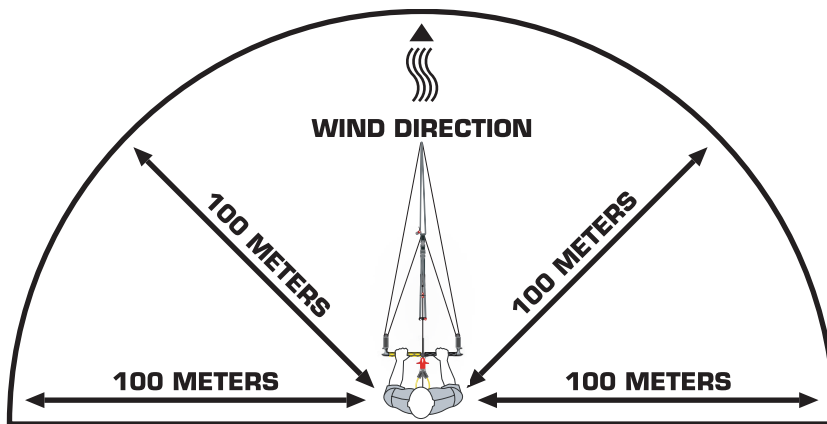

### KITE POSITIONS, ZONE & POWER

It is important to understand kiteboarding's basic zones of power before you launch a kite. **MANY OF THE ACCIDENTS THAT HAPPEN IN KITEBOARDING** happen on land, and many also happen when kiteboarders put their kites in what is called neutral position. Unfortunately, people often think that the kite is stable in neutral position. However, wind fluctuates-it gusts and lulls-and in neutral position, something known as lofting can occur when wind fluctuates. When a kite luffs (or receives less wind in its foil), the kite will move slightly away from the pilot. When a gust hits, the kite receives a surge of power, and often that surge of power is too much for a kiteboarder standing with the kite high overhead. As a result, the kiteboarder may be lofted (lifted) into the air. Lofting can be serious, but you may reduce the chances of lofting by understanding the power zones, and by avoiding putting your kite in the neutral position while on land.

## POWER ZONES





# HOW TO:

## AREA OF OPERATION / KITE POSITIONS, ZONES & POWER

**Neutral Position** - This is the position just above the pilot's head in the sky. If the pilot levels out the bar, the kite will gravitate to the neutral position. However, it is difficult and dangerous to keep the kite in this position. Although in this position the kite may feel steady and may feel like it has the least amount of power or pull, it is also the position in which on land the pilot is most susceptible to lofting. On the water, the neutral position can be utilized to rest while you reel in your board, but on land, we strongly suggest you do not utilize the neutral position. After launching, it is best to make your way to the water without delay. Do NOT linger on land with the kite in neutral position. It is VERY dangerous.

**Lofting** - Lofting occurs when the kite is above the riders head in the neutral position. Instability in the wind can cause sudden vertical force and lift a rider off of their feet.

**Neutral Zone** - This is the area that includes the neutral position and the area to the left and right of the pilot. It encompasses the most upwind or windward positions in which to fly the kite. When flown here, the kite has less power or pull than when it is in the power zone. However, use caution when the kite is in this zone, especially when on land, and especially in gusty wind conditions.

**Power Zone** - This is the area in front and to the sides of the pilot, but excluding the neutral position and zones. It is the area in which the kite has the most power and pull. When flown in this area, the kite can be powerful and dangerous, so avoid flying your kite in this zone when learning. Use extreme caution when flying the kite in this zone.

**Generating Power** - One way to generate power from your kite is by steering your kite from low to high or from high to low in the sky. The movement of your kite in the sky creates lift, which creates power. Keep this in mind, especially when learning. When bringing the kite from a low position up to the neutral position, the movement of the kite actually creates power and generates speed, so be prepared. When under-powered, you may use this ability of the kite to your advantage by creating power and speed to get planing.





# HOW TO: STEER

## STEERING

### **⚠ WARNING**

**This is a partial list of techniques to be remembered and applied. Be certain to always take instruction from a professional.**

#### **Key Points to Remember**

- When practicing steering a kite on land, always remember that your kite has extreme power. Be prepared. We suggest you develop your kite handling skills on land with a trainer kite, and then move to the water for further practice using the “body dragging” techniques with your power kite.
- When first learning to fly your kite, always keep your eyes on the kite.
- Steer slowly. Do not make any abrupt motions with the control bar.
- Keep in mind the power of the kite.
- Never turn the control bar like a car steering wheel. It is ineffective for steering the kite and may actually cause the kite to become out of control.

#### **Steering the Kite to the Left**

- Hold the bar with both hands, shoulder distance apart.
- With your eyes on the kite, slightly pull on the control bar with your left hand, pulling it toward your body.
- This will allow your left arm to bend and your right arm to extend. Keeping one arm extended is important; do not pull both arms toward your body at the same time.
- Pull slowly. The quicker your movements, the faster the kite will turn and the more power it will create.
- Once the kite starts to turn, it will continue to turn left unless you “tell it” otherwise.
- Be ready to steer the kite in the other direction.

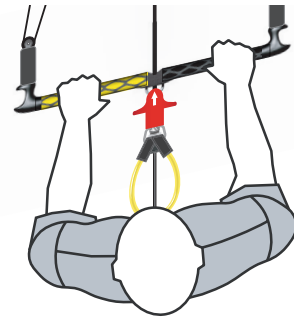

#### **Steering the Kite to the Right**

- Hold the bar with both hands, shoulder distance apart.
- With your eyes on the kite, slightly pull on the control bar with your right hand, pulling it toward your body.
- This will allow your right arm to bend and your left arm to extend. Keeping one arm extended is important; do not pull both arms toward your body at the same time.
- Pull slowly. The quicker your movements, the faster the kite will turn and the more power it will create.
- Once the kite starts to turn, it will continue to turn right unless you tell it otherwise.
- Be ready to steer the kite in the other direction.

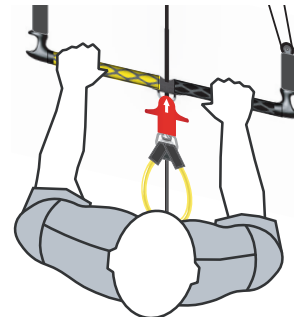



# HOW TO: PLANNING YOUR LAUNCH

## **⚠️ WARNING**

### Planning Your Launch

- Choose an area where you have at least 100 meters of space to your left and right and especially downwind of you.
- Set up your equipment so that your kite is downwind of where you will be launching, but most importantly, so that it is at an angle off of the wind.
- **DO NOT SET UP YOUR KITE FOR A STRAIGHT DOWNWIND LAUNCH!** The kite will launch with too much power and you will endanger the lives of yourself and those around you if you launch in this manner.
- Basically, if the wind is at your back, and straight downwind is at a  $180^\circ$ , then you will want to set your kite at about a  $100^\circ$  off the wind, either to the left or to the right of you.
- The more the kite is positioned into the wind when you launch, the less power it will have when it goes up, and the easier your launch will be.
- Your partner will stand with the kite while you will stand 30 meters away at your control bar.
- Make sure you launch slowly, and launch the kite at an angle, **NOT STRAIGHT DOWNWIND!**

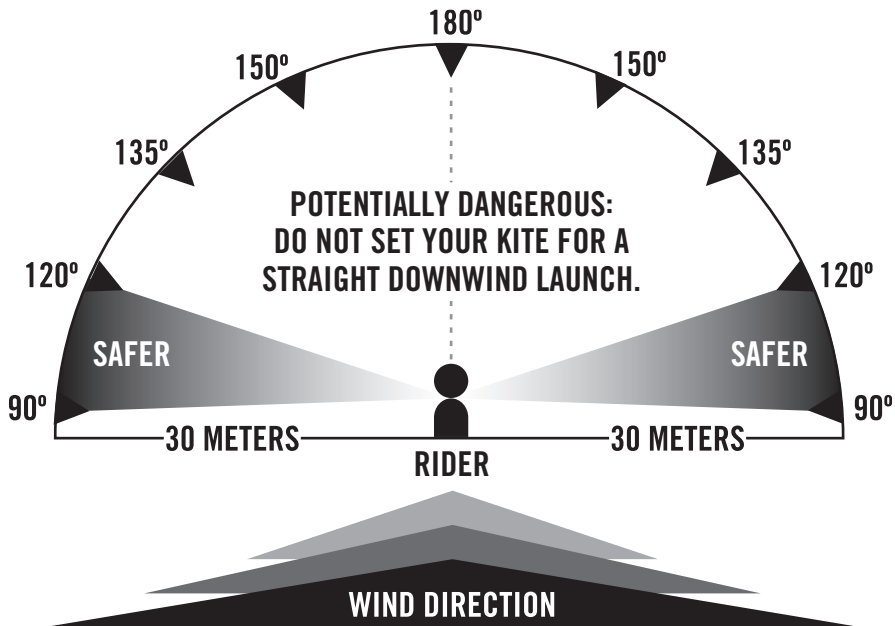



# HOW TO: LAUNCHING WITH A PARTNER

## LAUNCHING WITH A PARTNER

1. Before launching, re-familiarize yourself with your Quick Release System in the event that you must engage them. Make sure you have them properly set up.
2. Next, thoroughly check your lines, your gear, and your launching and landing sites; if all is okay, you are ready to launch your kite. Be certain your kite is properly inflated; this is imperative to the re-launchability of your kite.
3. Before you launch, organize a clearly defined release signal that you and your partner both understand.
4. Disengage the Override ball.
5. Next, engage the security pin.
6. Have your partner stand with the kite at 100° off of the wind.
7. Your partner should hold the kite in the middle of the leading edge, with the leading edge vertical and pointing into the wind.
8. Your partner should stand behind the kite and not to the side or in front of the kite.
9. Also, your partner **SHOULD NOT** touch the bridle or flying lines.
10. With the control bar in your hands and at chest height, take a few steps back to take the slack out of the flying lines.
11. Signal your partner to let go of your kite. It is important that your partner lets you steer the kite out of his or her hands.
12. **CAUTION:** Your partner **SHOULD NOT** throw the kite into the air. Instruct him/her against doing this **BEFORE** you launch. When the kite is thrown into the air, it hinders the ability of the kite to launch properly. When thrown, the kite may either launch too abruptly and powerfully or it may not launch at all. It is potentially a very dangerous way to launch.
13. Once your partner lets go of the kite, have him/her move upwind of you and out of your way.
14. **SLOWLY** steer the kite to the edge of the power window. **DO NOT** make any abrupt motions. The slower you steer the kite, the more in control you will be.
15. With the kite at the edge of the power window and the wind at your back, walk slowly to the water's edge, keeping in constant check with the kite. You should know what the kite is doing at all times.
16. If anything goes wrong with the launch, you should be ready to push the control bar away to depower the kite.
17. **CAUTION:** the more wind there is during your launch, the faster everything will happen. That is why it is important that you launch the kite slowly.
18. When you are an appropriate distance from any obstacles, you may engage the override ball. You will then need to use force to push the bar past the Override ball to immediately depower your kite.



# HOW TO:

## STEER / LAUNCH / LAND - LANDING A KITE TO YOUR PARTNER

### LANDING A KITE TO YOUR PARTNER

1. Prior to launching, make sure your partner has been instructed on how to land your kite properly.
2. Also, you should always determine adequate landing spots before you launch your kite.
3. Having done that, make sure that when you are heading toward shore, that your landing location is still un-crowded and un-obstructed.
4. Never land your kite over, on top of, or near others, especially if they are downwind of you. You should have an area clear of people, pets, power lines, trees, and other obstructions.
5. As you approach shore, keep your kite low near the water, at the edge of the power window.
6. Drop down (or step) off your board and body drag the final distance to shore. Do not approach the shoreline with speed.
7. Slowly steer your kite into the wind and to your partner.
8. Your partner should be on the windward side of your kite as he/she approaches it.
9. Once the kite is nearly touching the ground, your partner should grab the kite at the middle of the leading edge strut. He/she should grab the kite in the same location on the kite as when it was launched.
10. Your partner SHOULD NOT grab the kite bridles or flying lines.
11. Your partner should AVOID grabbing the kite by either wing tip or the trailing edge of the kite. Grabbing the kite by the wing tip or the trailing edge will often cause it to flip or spin; the kite will also be hard to manage.
12. Once your partner has the kite's leading edge, he/she should walk the kite away from the water's edge.
13. Your partner may either continue to hold the kite or he/she may secure the kite by turning it over, with the struts down and the leading edge pointed into the wind, and securing it with sand or sand bags.
14. Once on land, with your kite secured, you may wind up your lines.







# HOW TO:

## STEER / LAUNCH / LAND - RELAUNCHING

### RELAUNCHING YOUR Switchblade

Important CAUTION: Proper inflation of the struts, especially the leading edge, is imperative for re-launchability of your kite. Make sure your kite struts are properly inflated before entering the water.

- When your kite goes down on the water, know that the kite may re-launch on its own, often when you do not expect it to, so be prepared.
- If your kite goes down on its face, with the leading edge and struts facing the water, you must steer the kite onto its side in order to re-launch.
- Pull the rear leader line toward your body. Maintain constant tension on this leader line. CAUTION: Make sure not to wrap the leader line around your hand and do not allow your body to get entangled in the lines. You may need to pull as much as two meters of leader in order to lift the wingtip of the kite.
- HINT: Keep your board on your feet and in front of you. This will slow your forward momentum and increase the speed of relaunch.
- Once the wingtip begins to lift, the kite will soon roll onto its side.
- Once on its side, the kite will begin to move toward the edge of the wind window. You may have to finesse the kite to the edge of the window; to do this continue to hold onto the same leader line until the kite wants to re-launch.
- Sometimes, especially in light wind, you must be patient as the kite works its way to the edge of the wind window. Do not get impatient and start pulling on both sides of the bar. This only confuses the kite. Continue to work the kite to the original side you chose.
- When the kite is ready to re-launch, release the leader line and steer the kite up into the sky. Slowly steer your kite into the sky and level out your bar.





# HOW TO: TUNING THE KITE

## TUNING THE KITE

Proper tuning of your Switchblade kite is essential for best performance. A properly tuned kite increases its efficiency, speed, and allows the kite to de-power correctly. The following guidelines will help you to properly tune the kite to suit your style of riding.

- All models have a desired sweet spot that is achieved by the correct tension of the steering (back) and de-power (front) lines. Fine-tuning of the kite may be done by making small adjustments to the Centerline Adjustment Strap (CAS).
- Please note that, due to the full range of depower available in the system, the CAS is used to position the bar within the depower range. If you find yourself riding with you're arms fully extended and bent over at the waist, you can pull the red ball and the bar will move closer to you.
- The Switchblade is very sensitive to over sheeting. Too much back line tension can cause the kite to fly slowly or even backwards in light wind. Over sheeting will also minimize the amount of shutdown available in the depower range.
- Do not 'over sheet' the kite. The first objective is to set the kite's maximum power while allowing it to fly efficiently across the sky. More power and quicker turning is achieved by tensioning the steering (back) lines. This is called 'sheeting in the kite'. There is however, a point of diminishing returns. Too much back line tension will cause the kite to fly slowly across the sky and not allow it to fly to the edge of the power window.
- With the kite directly overhead, hook into the harness loop and fully sheet in (power up) the kite. If the kite is over-sheeted, the kite will sit back in the window. (CAUTION: beware of lofting. Leaving the kite overhead for long periods of time increases the risk of this phenomenon. If you feel yourself being lifted, sheet out immediately and be ready to pull your QRS).
- De-power the kite by pulling on the CAS until the desired effect is achieved. The more you pull on the CAS the less power the kite will have. Keep in mind that you will still be able to de-power the kite through the Depower Loop, so do not de-power too much with the CAS. To increase power, pull down on the large plastic loop on the CAS.

View of kite from riders perspective. Kite in the neutral position directly above the rider.

Over sheeted wingtip (too much back line tension)  
Front line too tight

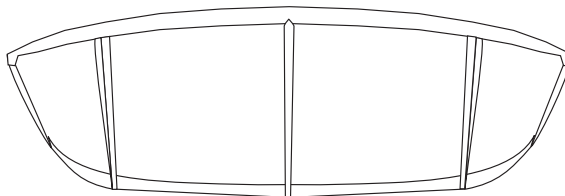

Correct Trim

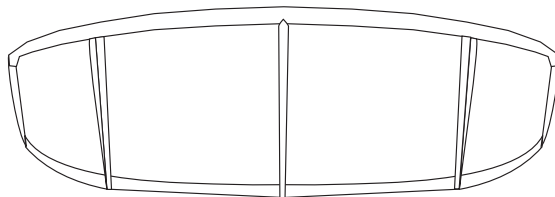



# REPAIRS

## TEARS / STRUT BLADDERS

### Major Tears

For a major tear in the kite fabric, consult your dealer for a reputable kite repair loft.

### Minor Tears

For a minor tear in the kite fabric, you may repair the tear with kite repair tape. Your kite has been supplied with an adhesive kite repair material.

1. Clean and dry your kite.
2. Lay the kite flat on a clean, dry, smooth surface.
3. Cut two pieces of repair tape the same size, making sure they are each big enough to cover the entire tear.
4. Carefully cover one side of the tear with a piece of the repair tape. Gently rub the tape smoothly onto the surface of the kite.
5. Next, cover the opposite side of the tear with the second piece of repair tape, in the same manner as before.
6. Make sure the tape is secure.

### REPAIRING STRUT BLADDERS

#### Key Points to Remember

- Before attempting to repair one of your kite bladders, make sure your kite is clean and dry. Always keep your kite pump, valves and bladders free of sand, water and other things that will dirty them.
- Make sure the bladders are deflated.
- Avoid repairing your kite on the beach or in dirty, dusty, windy, or abrasive areas. It is best to find a clean, dry spot out of the wind. A grassy spot is ideal.
- You will need a set of flying lines and a bladder repair kit (supplied with kite) before you begin to repair the bladder.
- Keep track of all valve parts for later use.

1. First, lay the kite out flat with the struts facing up.
2. Detach the Velcro closure at the end of the damaged strut. This will open up the sleeve of the strut and will allow you access to the internal bladder. (Fig. 1)
3. Next, separate the Sprint inflation tube from the LE SPRINT valve at the affected strut by removing the tubing lock collar (LE valve) (Fig. 3).
4. Slide the air clip off of the tube (Fig. 4).
5. Remove the screws (2) from the base of the strut valve (Fig. 5). Keep track of the valve parts for later use.
6. Tie one flying line around the valve. Cinch it down well on the valve.
7. Gently insert the valve/tube down into the strut sleeve.
8. Go to the base of the sleeve and gently pull the bladder out of the sleeve. Detach the flying line and leave it in the sleeve. Having the flying line through the sleeve will allow you to easily replace the bladder once it is repaired.

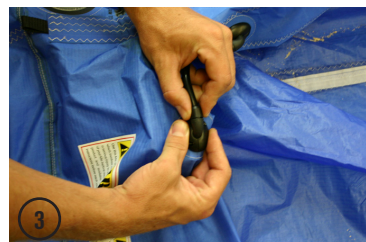
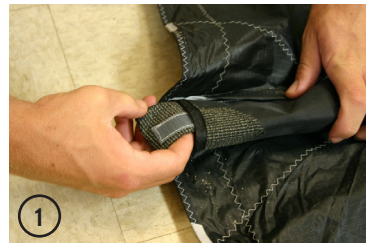



## REPAIRS

### TEARS / STRUT BLADDERS

9. Slide the air clip back onto the inflation tube. Inflate the bladder and clamp the tubing so that it maintains air. Do not over inflate the bladder.
10. Submerge the bladder in water to locate the hole. A bathtub or large sink full of water is best.
11. Look for bubbles to locate the hole.
12. Once you have located the leak, dry the area and mark the hole with a circle. A permanent marker works best for this. (Fig. 6)
13. Dry and clean the rest of the bladder with a soft towel.
14. Again, deflate the bladder.
15. Decide whether to use the glue or a patch supplied in your bladder repair kit.
16. If the hole is on a seam, you will need to glue the area.
17. If the hole is on a flat area of the bladder, remove the backing on one of the patches and press it onto the bladder, covering the hole.
18. Set the bladder aside for approximately 20 minutes to dry.
19. Again, inflate the bladder and check to make sure it is now holding air.
20. If you have repaired the holes in the bladder, coat the entire bladder in talcum powder to assist insertion back into the sleeve. (OPTIONAL)
21. Deflate once again.
22. Tie the flying line from the end of the strut opening onto the valve.
23. Lay the bladder flat at the end of the strut, so that you may now feed it back into the sleeve.
24. Gently feed the valve, followed by the rest of the bladder, into the sleeve.
25. From the valve opening of the sleeve, you will pull the flying line out of the sleeve, while pulling the bladder back into place.
26. Once the bladder is replaced, pull the valve back into the hole of the sleeve and remove the flying line from its base.
27. Inflate the strut partially to make sure the bladder fits into all four corners of the sleeve.
28. Attach the Air Distribution tube and clip connected to the LE.

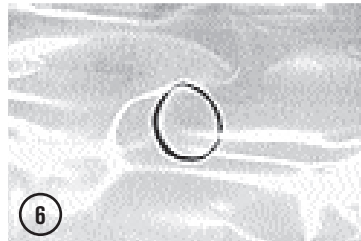



# REPAIRS

## LEADING EDGE BLADDERS

### REPAIRING LEADING EDGE BLADDERS

1. First, lay the kite out with the struts facing up.
2. Each end of the Leading Edge (LE) bladder is folded over and secured with a Velcro closure. You will also find a zipper access pocket at the center of the LE. Undo each Velcro closure and unzip the center access pocket. This will open up the sleeve of the strut and will allow you access to the bladder. (Fig. 1,2)
3. Separate the Airlock Valve Assembly from the leading edge. Carefully lift the retainer ring from the bladder. Using the small pull tab on the Velcro ring, carefully peel the Airlock base off of the inside of the LE. Keep track of the assembly for later use. (Fig. 3,4,5)
4. Next, disassemble the SPRINT valves. Remove the tubing lock collars of the strut valves (Fig. 6).
5. Slide the air clips off of each tube. (Fig. 7).
6. Remove the screws (2) from the base of each LE valve. (Fig. 8).
7. Keep track of the valve parts for later use.
8. For the next step, you will need two flying lines. Starting with one end of the leading edge, tie one line around the wing tip end of the bladder. Cinch the line down well. Using the second line, follow the same procedure with the other end of the leading edge bladder.
9. Next, gently push the valves down into the strut sleeve.
10. Now, access the leading edge bladder through the zippered access pocket near the leading edge valve. (Fig. 2)
11. Gently pull one side of the bladder out of the sleeve at a time, leaving the flying line through both sides of the sleeve. Having the flying line through the sleeve will allow you to easily replace the bladder once it is repaired.
12. Once out of the sleeve, attach the air clips. Inflate the bladder and close all clips and the airlock valve so that it maintains air. Do not over inflate the bladder.
13. Submerge the bladder in water to locate the hole. A bathtub or large sink full of water is best. You will need to submerge one section of the bladder at a time in order to locate the hole. Look for air bubbles to locate the hole.
14. Once you have located the leak, dry the area and mark the hole with a circle. A permanent marker works best for this. (Fig. 9)
15. Dry and clean the rest of the bladder with a soft towel.
16. Again, deflate the bladder.
17. Decide whether to use the glue or a patch supplied in your bladder repair kit.
18. If the hole is on a seam, you will need to glue the area.
19. If the hole is on a flat area of the bladder, remove the backing on one of the patches and press it onto the bladder, covering the hole.

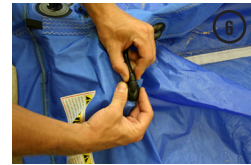
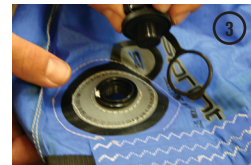



# REPAIRS

## LEADING EDGE BLADDERS

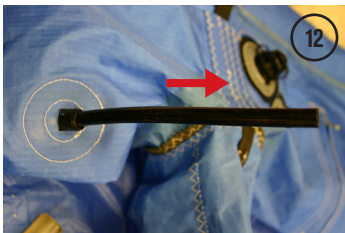
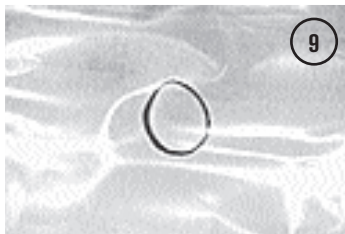
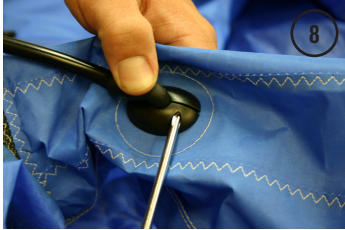

20. Set the bladder aside for approximately 20 minutes to dry.
21. Again, inflate the bladder and check to make sure it is now holding air.
22. Deflate once again.
23. Tie each flying line to the corresponding ends of the bladder.
24. Lay the bladder flat near the center access pocket and fold it, accordion style, so that you may feed each end back into the sleeve without twisting the bladder.
25. Starting with one end, feed the bladder into the access pocket.
26. Walk to one end of the leading edge and gently pull on the flying line, while holding the end of the sleeve. Slowly feed the bladder back into this side of the sleeve. (Fig. 10)
27. Next, follow the same instructions with the other side of the bladder, until the valves are near the holes and the bladder is fully inserted.
28. Tuck the ends of the bladder into the corresponding tips.
29. Once the bladder is replaced, pull the valves back into the holes of the sleeve. (Fig. 11)
30. Next, place the SPRINT valves back into position. (Fig. 12)
31. Making sure not to catch the internal bladder in the zipper, close the center LE zipper pocket. Next, fold over wingtip access pockets and secure the Velcro strips.
32. Re-attach the Airlock Valve Assembly.
33. Partially inflate the Leading Edge to make sure the bladder fits into all four corners of the sleeve.
34. Reassemble the SPRINT valves and connect the air distribution tubes to each strut.





# GLOSSARY

## FREQUENTLY USED KITEBOARDING & WIND TERMINOLOGY

### TRAINER KITE

A kite that may be used on land to simulate the motions used in kiteboarding. It is an excellent instructional and learning tool. Despite its small size, this kite still has power, so be alert.

### INFLATABLE KITE

A kite with inflatable tubes designed to float the kite and to facilitate water re-launchability.

### LEADING EDGE (LE)

The front inflated tube of your kite.

### STRUTS

The outer fabric tubes found on your kite. They house the inner inflatable bladders, which are filled with air to give structure to the kite.

### BLADDER

The inner inflatable tube found within the leading edge and the struts of the kite. (Imagine a bike-it has both a tire on the outside and an inner tube which holds air).

**AIRLOCK** - a 2 part valve that allows a single point for inflation and deflation of the kite.

### SPRINT

Single Point Rapid Inflation Technology.

### AIR CLIPS

Clips that prevent air transfer between the LE and the struts

### AIR DISTRIBUTION TUBES

Tubes that connect the LE bladder to the strut bladders.

**VERRIDE** - Is a system designed to limit the travel of the control bar under normal riding conditions. It allows the rider to spin the bar after rotations without depowering the kite too much. Also acts as a line manager for the depower extensions.

**VERRIDE MODE** - The area of the de-power mainline above the Override sleeve

**VERRIDE SLEEVE** - The plastic tube located on the de-power main line that provides the fixed point onto which the Override Unit snaps

**VERRIDE UNIT** - the plastic fitting that keeps the bar from entering into Override Mode. It can be pushed out of the way to enter into Override Mode.

### QRS-QUICK RELEASE SECURITY SYSTEM

Connection points on the control systems that the rider may release in an emergency. QRS Harness Leash (Patent) that is attached to the rider and kite, designed to disconnect you in an emergency.

### BYPASS™ LEASH SYSTEM

An optional security leash feature that is recommended for first time users and kiteboarding schools, and for riders who kiteboard without being hooked into the harness loop.

### CONTROL BAR

The steering device the rider uses to steer the kite.

### BRIDLES

The lines that hang from the wing tips and leading edge of the kite. The flying lines will be attached from the control bar to these bridle lines in order to connect control bar to kite.

**Tow Points** - The attachment points for the bridle

### LEADER LINES

The lines that attach directly to the control bar. You will attach these lines to the flying lines in order to connect them to your bar.

### FLYING LINES

A term used to describe all four of the lines included with your kite package. These lines connect the bridle lines on the kite to the leader lines on the control bar and are typically 20-30 meters in length.

### STEERING LINES

The two outside flying lines that attach to the trailing edge bridles on the kite-one to the left wing tip and the other to the right wing tip.

### DE-POWER LINES

The two center flying lines that attach to the leading edge



# GLOSSARY

bridles on the kite—one to the left wing tip, the other to the right wing tip. These lines assist in de-powering the kite.

**Centerline adjustment strap (CAS)**—  
Used to depower the kite by changing the relationship between the front and back line lengths. It is also used to position the bar closer to the rider.

**TENSION RING** – A ring located on the Override unit that allows the rider to adjust the release load required to enter into Override Mode.

**FLAGGING RING** - The ring to ring connection that acts as an alternate leash attachment point. By connecting to the flagging ball and releasing the control system the rider is left connected to the kite by one line.

**HARNESS**  
A piece of equipment used to temporarily attach the rider to the control bar harness line. This enables the rider to save energy by utilizing their body weight and all of their muscles to hang on to the kite. Most common are the waist harness (attaches around the torso) and the seat harness (attaches to the waist and around the legs)

**KITEBOARDING**  
The term used to describe the sport of power kiting on water.

**KITESURFING**  
Another term used to describe the sport of power kiting on water.

**NEUTRAL POSITION**  
This is the position just above the rider's head in the sky. If the rider levels out the bar, the kite will gravitate to the neutral position. However, it is difficult and dangerous to keep the kite in this position. Although in this position the kite may feel steady and may feel like it has the least amount of power or pull, it is also the position in which on land the rider is most susceptible to lofting. On the water, the neutral position can be utilized to rest while you reel in your board, but on land, we strongly suggest you do not utilize the neutral position. After launching, it is best to make your way to the water without delay. Do NOT linger on land with the kite in neutral position. It is VERY dangerous.

**NEUTRAL ZONE**  
This is the area that includes the neutral position and the area to the left and right of the rider. It encompasses the most upwind or windward positions in which to fly the kite. When flown here, the kite has less power or pull than when it is in the power zone. However, use caution when the kite is in this zone, especially when on land, and especially in gusty wind conditions.

**POWER ZONE**  
This is the area in front and to the sides of the rider, but excluding the neutral position and zones. It is the area in which the kite has the most power and pull. When flown in this area, the kite can be powerful and dangerous, so avoid flying your kite in this zone when learning. Use extreme caution when flying the kite in this zone.

**LAUNCHING**  
The motion in which the rider steers the kite from their partner's hands into the sky.

**SELF LAUNCHING**  
A technique in which the rider launches the kite without assistance, usually by weighting down a wing tip with sand until he/she is ready to launch.

**RE-LAUNCHING**  
The motion in which the rider steers the kite off of the water and back into the sky.

**BODY DRAGGING**  
This is an instructional tactic / step in which the rider flies the kite while in the water, but without the board. The rider will launch, then walk to the water, and basically drag in the water while practicing flying, re-launching and self-rescue techniques.

**WATER STARTING**  
The motion of the rider in which he/she goes from sitting or lying in the water to standing on the board.

**GYBING**  
The motion in which the rider changes the direction of the board he/she is riding. The rider switches from a starboard tack to a port tack or vice versa.





# GLOSSARY

## PLANING

The point in time in which the rider gets the board skimming on the water.

## LANDING

The motion in which the rider steers the kite into their partner's hands on shore.

## OVER-POWERED

A situation in which the rider has a kite too powerful for his/her ability level, weight, strength, and/or wind conditions.

## UNDER-POWERED

A situation in which the rider has a kite not powerful enough for his/her weight, strength, and/or wind conditions.

## REACH

A direction of travel relative to the wind direction. Generally 90-160 degrees off the wind.

## LULL

A term used to describe wind when it lessens in strength, for any amount of time. A term also used to describe the complete de-powering of a kite.

## LUFF

A term used to describe what happens to the kite in a lull.

## SIDESHORE

Wind is blowing from the left or from the right, parallel to the shore. Ideal wind direction for kiteboarding.

## ONSHORE

Wind is blowing directly or to a great extent directly from the water toward the land. Do not operate your kite in or near water in this wind direction.

## SIDE ONSHORE

Wind is blowing from either the left or the right and from the water toward the land. This is a combination of onshore and sideshore wind. Utilize caution when operating your kite in or near water in this wind direction.

## OFFSHORE

Wind is blowing from the shore directly or to a great extent out to the water. Do not operate your kite in or near water in this wind direction.

## SIDE OFFSHORE

Wind is blowing from either the left or the right and from the shore out to the water. This is a combination of offshore and sideshore wind. Do not operate your kite in or near water in this wind direction.

## GUSTY WIND

Wind is inconsistent and varies considerably from one wind strength to another.

## DOWNWIND

The direction in which the wind is traveling.

## UPWIND

The direction from which the wind is blowing.

## LEEWARD

The downwind side of the kiteboarder.

## WINDWARD

The upwind side of the kiteboarder.

## KNOTS

A measure of speed based on nautical miles.

1 knot = 1 nautical mile per hour.

1 knot = 1.15 miles per hour.

1 knot = 1.85 kilometers per hour.

## MPH

Miles Per Hour. A measure of speed.

1 mph = 1.6 kilometers per hour.

## BEAUFORT SCALE

A system for estimating wind strength based on the effects wind has on the physical environment (e.g. the behavior of waves, smoke, etc.). Instruments are not used to determine wind strengths in this point scale (0 = calm to 12 = hurricane).

PUMP - Device used to inflate the kite

BAR (unit) - A unit of pressure

- 1 bar = 14 PSI

- 1 mbar = 0.015 PSI

PSI - A unit of pressure. Pounds per square inch

- 1 PSI = 68.9mbar