



CROSSBOWIDS™

KITE USER MANUAL

CABRINHA®

WARNING

DO NOT USE THIS PRODUCT UNLESS YOU HAVE READ AND UNDERSTAND THESE WARNINGS, CAUTIONS, AND INSTRUCTIONS WHICH ARE FOR YOUR SECURITY AND PROTECTION. THIS INFORMATION MAY BE SUBJECT TO CHANGE AT ANY TIME. FOR CURRENT UPDATES, PLEASE VISIT OUR WEBSITE AT: **WWW.CABRINHAKITES.COM**

IF YOU ARE BELOW THE AGE OF 18, YOU SHOULD HAVE YOUR PARENT OR GUARDIAN READ THESE WARNINGS, CAUTIONS AND INSTRUCTIONS AND SHOULD NOT USE THIS PRODUCT UNLESS YOU ARE UNDER THE PROPER GUIDANCE AND SUPERVISION OF SUCH A PERSON.

The use of this product exposes the user to many unavoidable and unexpected risks, injury, dangers and hazards. The suppliers of this product are not responsible for any damage to property or any personal injury caused by any use, misuse, abuse or irresponsible use of this product by the user.

Kiteboarding is a hazardous sport. Power kites and their lines and control equipment can be dangerous to flyers and to anyone in the vicinity of their use. Kiteboarding must be taken seriously and we recommend that, at least in the early stages of your use, you seek the guidance of professional instructors and experienced kiteboarders. Improper and/or unreasonable use of this kite may result in death or serious injury to any part of your body and to others. Do not use your kite near power lines, airports, buildings, automobiles, trees, streets, etc. and keep your kite fly lines away from people and all obstacles. Always fly in an open area and observe wind and weather conditions, particularly in circumstances where you may encounter offshore, onshore winds or strong winds. Do not attempt to use your kite on water until you are confident and comfortable with the use of a trainer kite on land. Spend time to become familiar with the operation of your kite and remember that you are responsible for its operation and for the security of those around you. As you learn the sport, work within your own limitations and do not exceed them. If you intend to use the kite on water, always use appropriate protective gears and flotation devices and do not attach yourself or tie yourself permanently to the kite lines. The kite is not intended for use as a flying device nor indeed is it intended as a means of flotation.

...continues to next page

! WARNING

RECOMMENDED KITEBOARDING PRACTICE:

Kiteboarding is an extremely diverse sport, with many disciplines and ability levels. As with all sports, there can be certain inherent risks. The following contains key security points to remember when operating your Cabrinha kite.

- Kiteboarding is a HAZARDOUS activity and the use of Kiteboarding equipment involves the risk of serious personal injury to any part of the user's body or death.
 - Injuries are an INHERENT RISK of kiteboarding and the participation in kiteboarding implies the user's acceptance and assumption of those risks.
 - Children should always be under adult supervision.
 - It is strongly recommended that beginners take lessons.
 - ALWAYS inspect your equipment for signs of wear and tear each time before use, particularly all lines, canopy, bladders, screws and fittings.
 - IF any products are found to show signs of wear & tear these should be repaired or replaced immediately and before further use. If in doubt about any signs of wear & tear, please contact your local vendor. Contact details are available from www.cabrinhakites.com
 - NEVER place yourself in a situation where breakage of any one of the various kiteboarding components would pose a risk to yourself or others, or make it difficult to return to the shore securely & unassisted.
 - Make sure you use properly designed and manufactured parts from reputable suppliers.
 - Take time to study the conditions including sea state, tides, currents, weather conditions and forecasts before you decide to go sailing. Beware of sailing in offshore, onshore or strong winds.
 - Familiarize yourself with any new location before venturing onto the water. Ask the locals to tell you about any hazards.
 - Watch out for other beach users, especially swimmers and small children. Make sure you keep your board and rig under control at all times and that they don't get blown about on the beach or in the water.
- Always use appropriate protective gear and flotation devices. Wear the correct protective clothing for the conditions such as a wetsuit or a UV top. It is recommended to wear a helmet.
 - Make sure someone knows where you've gone & when you are expected back – always sail with a buddy.
 - Be aware of the conditions as they change. Always return to the beach if there is a significant change in the conditions, i.e. wind dropping or wind & waves increasing.
 - As you learn the sport, work within your own limitations and do not exceed them.
 - Do not alter, modify or change this product.
 - This product is designed and manufactured only for kiteboarding on water or snow.
 - Keep these warnings, cautions and instructions for future reference.
 - The following contains key security points to remember when operating your Cabrinha kite, and associated kiteboarding equipment on water, land or snow

WARNING

SNOW USE GENERAL GUIDELINES

- The points listed under the Recommended Kiteboarding Practice also apply to the use of this product on the snow. Please read the previous paragraphs even if you intend to use this product primarily on the snow.
- These kites are intended for use on the snow as a traction device to propel a rider across wide open snow fields in a controlled and appropriate manner.
- Do not attempt to use this kite as a flying device. Do not use this kite to soar from ridges, cliffs or slopes.
- Do not attempt to launch yourself into the air in any manner which can create excessive impact to the rider upon landing.
- Extreme caution must be taken when using this kite in any mountainous region, uneven terrain or glacier. Wind conditions in these areas are notoriously unstable and can change in velocity and direction without notice.
- Never use this product in the vicinity of powerlines, lifelines, trees, or other obstacles.. Contact with these obstacles can cause severe injury or death.
- Do not tether yourself to any stationary or moving object such as a stake, snowmobile, or car while flying this kite.
- Always stay in control and be able to stop or avoid other people or objects
- SNOWKITE: People downwind or down slope have right of way. It is your responsibility to avoid them
- SNOWBOARD: People down slope have right of way. It is your responsibility to avoid them
- You must not stop where you obstruct others or are not visible.
- Whenever starting or merging with others look upwind/up hill and yield to others.
- Always use devices to help prevent runaway equipment.
- Observe any and all posted signs and warnings
- Keep out of closed areas
- SNOWBOARD: Prior to using any lift you must have the knowledge and ability to load, ride and unload safely.
- Do not snowboard/snowkite when tired or under the influence of alcohol or drugs.
- Snow terrain and snowboarding/snowkiting conditions vary constantly--watch out for and avoid any man made structures, trees, rocks, debris, variations in terrain or slopes, avalanche areas, crevasse, cliffs, power lines, water hazards, changes in snow surfaces or texture due to altitude and sun exposure, wind and weather changes, and any other conditions which could affect your ability to properly control your snowboard/snowkite.



CROSSBOW IDS™

INDEX

USER MANUAL

- 2 Introduction
- 3 Important Information
- 4 Wind, Water, & Weather Conditions / Wind Range Chart
- 5 Know Your Ability Level / Kiteboarding Location
- 6 Kite Care
- 7 Beach Etiquette
- 8 Area of Operation
- 9 Kite Positions, Zone & Power

KITE OVERVIEW & CONTROL SYSTEM

- 10 CROSSBOW IDS™ Overview

SETUP

- 12 Sprint™ Inflation System
- 13 Inflating the Kite
- 15 Pause

HOW TO:

- 16 Tuning
- 17 Repairs - Tears / Struts Bladders
- 19 Repairs - Leading Edge Bladders

- 21 Glossary

INTRODUCTION



THANK YOU

for purchasing a Cabrinha kite and welcome to the sport of kiteboarding.

As you may know, the excitement of Kiteboarding is attracting people of all ages from all corners of the globe. It's one of the most dynamic and fastest growing sports in the world.

CAUTION: Kiteboarding can be overwhelming if not approached in an educated manner. That's why we have supplied this extensive user's manual. It will help to educate you about your new kite and about the ways in which to use it. It contains information regarding the setup, care and maintenance of your kite. For information about operation of the kite including how to control its power you must refer to the manual supplied with your Cabrinha control system. Please note that only IDS™ equipped, CROSSBOW compatible control systems will provide all of the security and performance functions associated with this bow kite. Consult www.cabrinhakites.com for a list of compatible control systems for use with this kite.

Please read this user's manual carefully and entirely before using this kite. This manual is not intended to replace proper kiteboarding instruction, but rather to supplement it. Do not attempt to kiteboard without appropriate instruction. It will make this sport more enjoyable, not only for yourself, but for those around you.

IMPORTANT INFORMATION

IMPORTANT INFORMATION

Kiteboarding is a hazardous sport, with many disciplines and ability levels. As with all sports, there are inherent risks of injury. The following contains key points to remember when operating your Cabrinha kite.

- Be familiar with the set up and use of the supplied security systems: IDS™ and the Harness Loop Quick Release systems.
- Make sure your control system is rigged and used according to the supplied instructions.
- Make sure your kite is compatible with the control system.
- Always use your Cabrinha kite with a bypass leash.
- NEVER permanently attach yourself to this kite, the control bar, or lines.
- NEVER use this kite as a flying device.
- NEVER touch the kite lines while they are under tension; do not catch the kite using these lines.
- When inflated but not in use, secure your kite with sand or with something heavy and non-abrasive; the more weight the better (see “Kite Care” for more information). An inflatable power kite will still fly, even without a rider, so be mindful of those around you and secure your kite. Your kite may cause serious injury or death if it launches unexpectedly.
- Do not lend your gear to someone who has not been fully instructed on the use of inflatable kites. Other users should also read this user’s manual and be proficient in all its points.
- Check your gear before going on the water. Insure that your flying lines, security systems, kite, board, etc. are all rigged properly and are in working order.

PROTECTIVE GEAR

We strongly recommend the use of the following protective gear:

- Helmet
- Life Jacket, Impact Vest, or Flotation Vest
- Neoprene Wet Suit
- Gloves
- Foot Protection
- Eye Protection
- Knife
- Sunscreen

IMPORTANT INFORMATION

WIND, WATER, AND WEATHER CONDITIONS

- Do not underestimate the power of the wind.
- Be aware of unpredictable and changing weather conditions.
- Avoid “offshore” or “onshore” wind conditions.
- Avoid strong, gusty wind.
- Be careful of wave conditions, especially when learning.
- Be educated about tides and rip currents.
- Be mindful of your ability level. Do not kiteboard if conditions are beyond your ability level.
- Be educated about air and water temperatures and wear appropriate protection against the elements.
- Do not use this product in thunderstorms.
- Consult an anemometer to determine wind speeds if necessary.
- Do not use an oversized kite. Consult your Wind Range Chart for the correct recommended size. Use your common sense. If in doubt about what kite size to use, choose smaller rather than bigger.
- Make certain that you are physically capable of operating the security Quick Release (QR) and IDS™ devices provided with this kite. This kite and control system has been designed around a typical rider weight of 75kg.

Riders with a weight greater than 75kg may need to use more force to operate the QR than lighter riders. Increases in wind strength may also result in greater force being required to operate the QR. Be certain to seek the advice of a professional such as your Authorized Cabrinha Dealer about the performance of the security systems in relation to body weight.

WIND RANGE CHART

This wind range chart is only to be used as a point of reference. It is based upon a rider who is approximately 170 lbs. (75 kg). Actual use may vary based on your body weight, ability level, water conditions, board size, and riding style. When choosing a kite size, please use your personal experience, common sense, and always check what other riders are using on the water for a size reference. Lighter riders should use a smaller kite and heavier riders may need a size larger. Be certain to seek the advice of a professional such as an instructor or Authorized Cabrinha Dealer before making your decision.

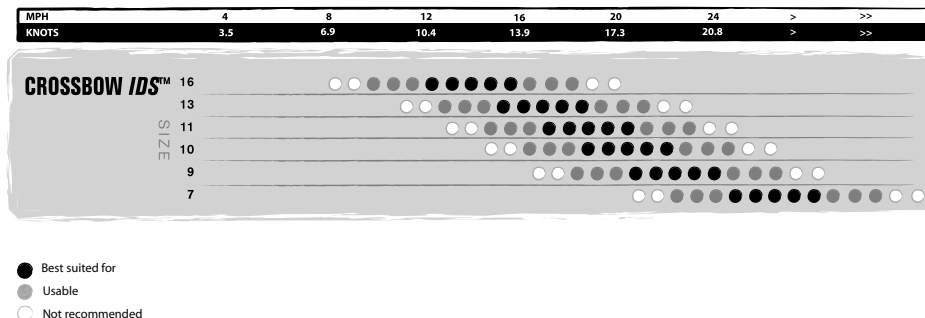

IMPORTANT INFORMATION

KNOW YOUR ABILITY LEVEL

- Do not attempt kiteboarding without appropriate instruction.
- Do not kite alone.
- Launch, land, and ride together with a partner or have someone on shore who can keep an eye on you.
- Make sure you are in good physical condition before using this product.
- Practice flying a small, traction kite or a “trainer kite” before flying this kite.
- The more time spent on the “trainer kite”, the faster you will learn.
- Make sure you are a proficient swimmer before using this product in or near the water.
- Make sure the wind and water conditions are within your ability level and that you have made the correct equipment choices.
- Never kiteboard further from shore than you are reasonably able to swim back.
- Always save a reserve of energy; end your kiteboarding session before you are exhausted.
- Make sure you’ve done your homework and that you know the security precautions of all aspects of the sport: rigging, launching, landing, flying, riding, kiting among other water users, self rescuing, etc.
- Understand and practice operating your security systems before ever launching your kite.
- Understand the technique of self-rescue before using this product in or near the water.
- Never let someone who is not familiar with inflatable kites launch, catch, or use your kite. You will endanger them, as well as yourself and those around you.
- You are responsible for the proper operation of your kite.

KITEBOARDING LOCATION

- Observe local laws and regulations regarding this product and the usage area.
- Talk to the local riders about the weather conditions and beach rules.
- Check your area thoroughly before launching your kite.
- Make sure you have considerable space in which to launch, land, and use this product.
- You should have at least 100 meters of space from all objects on both sides and downwind of you. Be especially aware of your downwind area.
- Be mindful and aware of the wind direction in relation to your launch area.
- Avoid areas with rocks and/or shallow or exposed reefs.
- Be mindful of tide changes. As water levels change, you may be exposed to new obstructions.
- Avoid launching, landing or using this product near power lines, telephone poles, trees, people, pets, buildings, automobiles, streets, sharp objects and airports.
- Avoid crowded beaches and waterways.
- Make sure your lines do not cross a walkway or passage.
- Do not let others walk between you and your kite.
- Be careful and mindful of other water users, including windsurfers, boaters, jet skiers, swimmers, floating objects, etc.
- Before launching, make sure you have scouted a backup landing area, in case you do not make it back to your launch spot.

IMPORTANT INFORMATION

KITE CARE

Due to the often extreme nature of kiteboarding, a thorough approach should be taken when caring for your kite and all its associated rigging, as well as your protective gear.

PREPARING FOR YOUR SESSION

- Thoroughly check your protective equipment (helmet, etc.) to make sure it is in working order and in good condition.
- A frequent inspection of the kite and the control system should be made in order to identify punctures, tears, or abrasions in the canopy, struts, or security systems. It is also necessary to check the fly lines for wear and for unwanted knots, which may reduce the strength of the fly lines. Check bridle lines and pulley's for wear.
- Do not rig on asphalt, cement, gravel, or other abrasive surfaces; doing so may damage your equipment. It is best to rig on sand or grass. Damage done to your equipment by rigging on abrasive surfaces will not be covered under warranty.
- Do not rig among sharp objects that could tear the canopy or puncture the struts and leading edge bladder.
- Take care not to expose your flying lines to sharp objects that may wear through them.
- While setting up, secure your kite with sand or sand bags. Do not secure your kite with rocks or other sharp or abrasive objects that may damage your kite.

BETWEEN SESSIONS

- Never leave an inflated kite unattended on the beach for a long period of time. Winds may shift or change and the kite may become unsecured and fly off.
- Do not leave an inflated kite (secured or not), directly exposed to the wind for any length of time. This allows the trailing edge to flutter excessively, which can damage the kite or tangle the bridles/control lines. If you must leave the kite exposed to the wind on the beach, place sufficient amounts of sand between each strut and near the trailing edge to minimize or stop the fluttering
- Do not leave your kite exposed to sunlight for long periods of time. Between sessions, choose a shaded area to secure your kite. When not in use, stow away.

PROPER STORAGE

- It is recommended to wash your kite with fresh water and dry thoroughly before rolling and storing.
- Do not roll up kite when wet.
- Clear the kite of sand or other foreign objects before stowing.
- Once it is clean and dry, stow your kite in the supplied bag in a clean, dry, cool place.
- Do not place heavy objects on the bag containing the kite.
- Do not leave your kite inflated in your car or car rack box; exposing the kite to extreme temperatures while inflated may damage the internal bladders.
- Wash your control system with fresh water from time to time by placing the entire control system (with lines wound onto the bar) into a bucket of fresh water and let it sit for 5 minutes. Allow to dry thoroughly before storing in a dry location.
- Once it is clean and dry, stow your control bar in the supplied bag in a clean, dry, cool place.

IMPORTANT INFORMATION

BEACH ETIQUETTE

Here are some basic things to consider when sharing beaches and water accesses with other users:

SAFETY

- Follow the instructions outlined in this manual.
- Follow the instructions and rules and regulations posted at the beaches you use.
- Check with local kiteboarding associations and shops prior to launching in a new area. There may be local rules and regulations to follow which are not posted.
- Utilize common sense.
- Do not touch other people's gear, unless instructed to do so by the owner. Picking up their bars, kites, etc. may disrupt a setup ritual they have.
- Always secure your kite with sand or sand bags. An unmanned kite is dangerous.
- Never leave an inflated kite unattended. Winds may shift and cause the kite to become unsecured and fly off.

SETTING UP

- Set up only the gear that you plan on using immediately. Deflate and put away your kites when not in use.
- Set up in an area where you have plenty of space.
- Set up in a manner conducive to having multiple users in the area.
- Roll up your lines when not in use.
- Always keep other beach and water access users in mind when launching, landing, and kiteboarding.
- Yield to other beach users. Be courteous and cooperative.
- Always be ready to lend assistance to other kiteboarders. The favor may be returned sooner than you think.

IMPORTANT INFORMATION

AREA OF OPERATION

This is the 100 meters of area with no obstacles to each side and downwind of the rider. Do not launch your kite if you do not have this distance between yourself and other people, or obstructions.

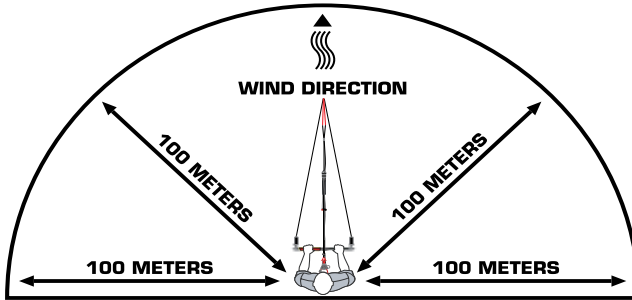

WARNING

Planning Your Launch

- Choose an area where you have at least 100 meters of space from all obstacles to your left and right and especially downwind of you.
- Set up your equipment so that your kite is downwind of where you will be launching, but most importantly, so that it is at an angle off of the wind.
- DO NOT SET UP YOUR KITE FOR A STRAIGHT DOWNWIND LAUNCH! The kite will launch with too much power and you will endanger the lives of yourself and those around you if you launch in this manner.
- Basically, if the wind is at your back, and straight downwind is at a 180° , then you will want to set your kite at about a 100° off the wind, either to the left or to the right of you.

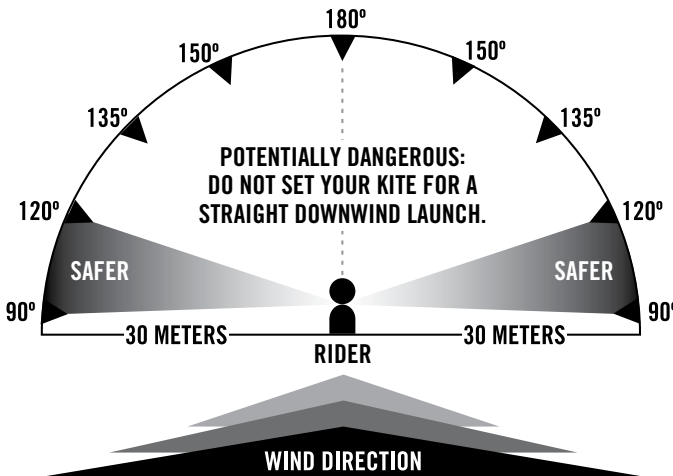

•The more the kite is positioned into the wind when you launch, the less power it will have when it goes up, and the easier your launch will be.

•Your partner will stand with the kite while you will stand 30 meters away at your control bar.

•Make sure you launch slowly, and launch the kite at an angle, NOT STRAIGHT DOWNWIND!

IMPORTANT INFORMATION

KITE POSITIONS, ZONE & POWER

It is important to understand kiteboarding's basic zones of power before you launch a kite. **MANY OF THE ACCIDENTS THAT HAPPEN IN KITEBOARDING** happen on land, and many also happen when kiteboarders put their kites in what is called neutral position. Unfortunately, people often think that the kite is stable in neutral position. However, wind fluctuates-it gusts and lulls-and in neutral position, something known as lofting can occur when wind fluctuates. When a kite luffs (or receives less wind in its foil), the kite will move slightly away from the pilot. When a gust hits, the kite receives a surge of power, and often that surge of power is too much for a kiteboarder standing with the kite high overhead. As a result, the kiteboarder may be lofted (lifted) into the air. Lofting can be serious, but you may reduce the chances of lofting by understanding the power zones, and by avoiding putting your kite in the neutral position while on land.



Neutral Position - This is the position just above the pilot's head in the sky. If the pilot levels out the bar, the kite will gravitate to the neutral position. However, it is difficult and dangerous to keep the kite in this position. Although in this position the kite may feel steady and may feel like it has the least amount of power or pull, it is also the position in which on land the pilot is most susceptible to lofting. On the water, the neutral position can be utilized to rest while you reel in your board, but on land, we strongly suggest you do not utilize the neutral position. After launching, it is best to make your way to the water without delay. Do NOT linger on land with the kite in neutral position. It is VERY dangerous.

Lofting - Lofting occurs when the kite is above the riders head in the neutral position. Instability in the wind can cause sudden vertical force and lift a rider off of their feet.

Neutral Zone - This is the area that includes the neutral position and the area to the left and right of the pilot. It encompasses the most upwind or windward positions in which to fly the kite. When flown here, the kite has less power or pull than when it is in the power zone. However, use caution when the kite is in this zone, especially when on land, and especially in gusty wind conditions.

Power Zone - This is the area in front and to the sides of the pilot, but excluding the neutral position and zones. It is the area in which the kite has the most power and pull. When flown in this area, the kite can be powerful and dangerous, so avoid flying your kite in this zone when learning. Use extreme caution when flying the kite in this zone.

KITE OVERVIEW

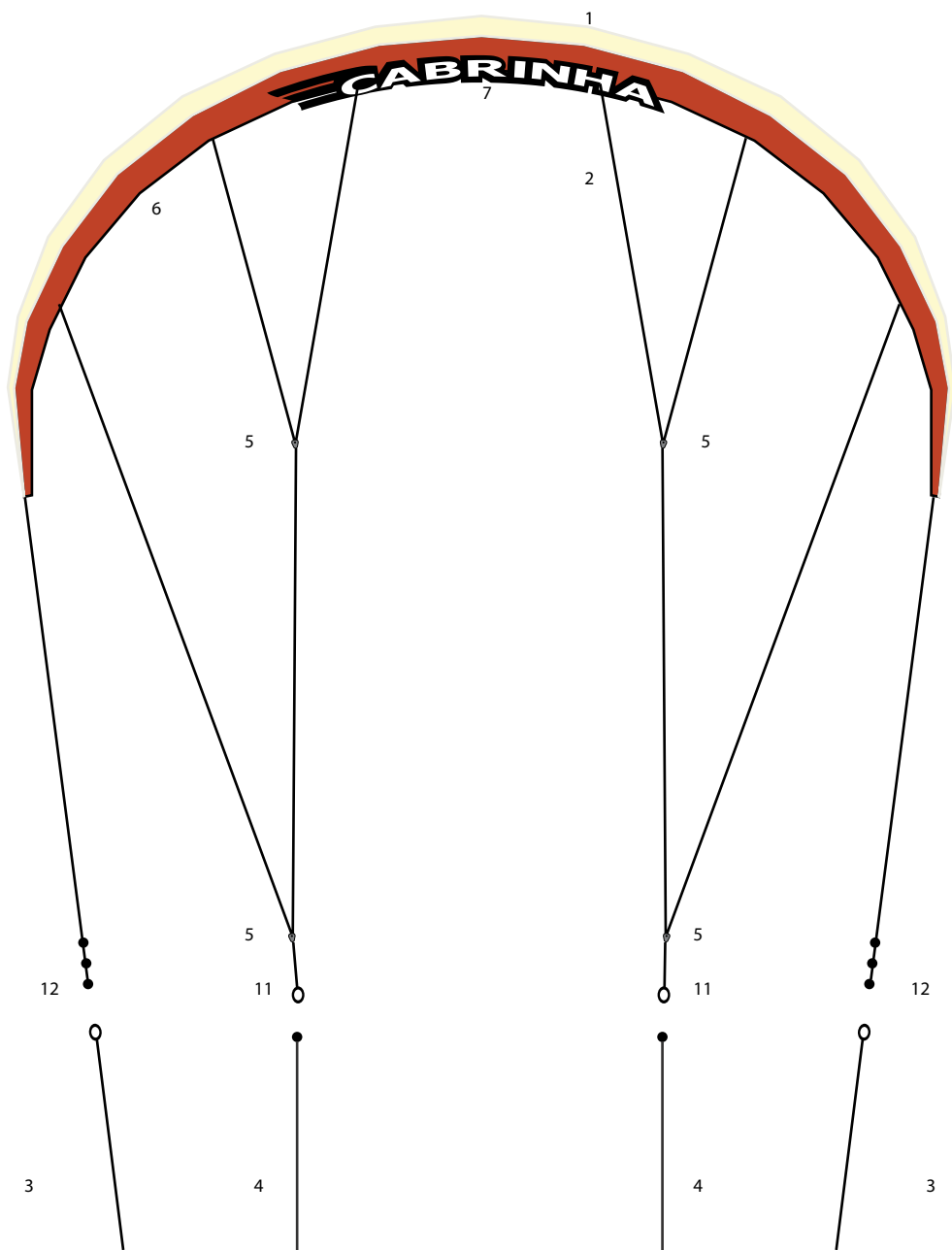

KITE OVERVIEW

OVERVIEW - CROSSBOW IDS™

- 1) Kite Body
- 2) Bridle
- 3) Steering (rear) Lines
- 4) Front (center) Lines
- 5) Pulleys
- 6) Leading Edge
- 7) Airlock™ High Volume Valve
- 8) Sprint™ Valves
- 9) Sprint™ Air Distribution Tubes
- 10) Sprint™ Air Clips
- 11) Front line attachment point
- 12) Rear line attachment point

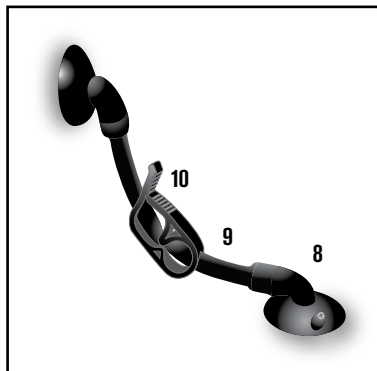

SETUP

SPRINT™ INFLATION SYSTEM

The SPRINT™ inflation system is a simple to use feature to quickly inflate your kite to an even pressure. The SPRINT™ system uses a single inflation point to connect your high volume, two way Cabrinha pump. As you pump your kite with air, all struts and your leading edge inflate quickly and simultaneously to the desired pressure. The supplied leash pump and threaded valve connection keeps your kite under control even when pumping up directly in the wind.

Once the kite is pumped you can choose to clip off the air to the struts. This way if you damage a strut while in use, the rest of the kite will maintain its pressure. At the end of the session you can choose to deflate your kite completely by disengaging the strut clips.

You can also keep your struts inflated and put your kite away rolled up so that the next session will take just minutes to set up.

SINGLE INFLATION VALVE FILLS THE ENTIRE KITE WITH AIR

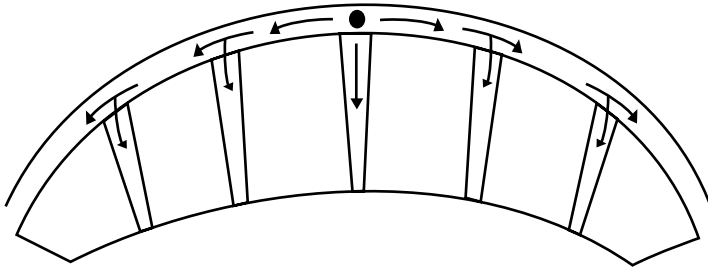

**AIRLOCK™
INFLATION/DEFLATION VALVE**

THE UPPER SECTION IS
THE INFLATION CAP

THE LOWER SECTION IS
THE RELEASE VALVE

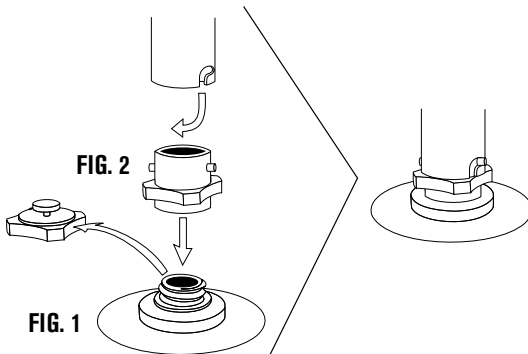
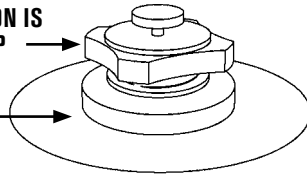

SETUP

INFLATION BASICS

See the section on Kite Care before inflating your kite.

- Unroll your kite with the struts facing up.
- Make sure your back is to the wind and that the leading edge of the kite is closest to your body. Secure the kite with sand to keep it from flapping in the wind.
- Use the supplied pump leash to connect the pump to the kite. This will free your hands to pump the kite.
- Open the inflation cap by turning it counter-clockwise. (FIG. 1)
- Make sure that the release valve is seated firmly by turning clockwise. Do not over tighten the release valve when the kite is not inflated. Doing so may twist and damage the bladder. The valve base is held in place by a Velcro strip
- Attach the pump using the supplied Cabrinha adapter (or use a standard nozzle). To attach the adapter, remove the adapter from the end of the pump hose. Thread the adapter on to the upper section of the Airlock™. Reattach the hose and pump the kite. (FIG. 2)
- Open all of the Air Clips to allow air to flow from the LE into the struts. (FIG. 3)
- When inflating, hold the pump with both hands and provide even pressure to the handle. This will help maintain the life of the Pump.
- Confirm that the corners of each strut under the leading edge are able to fully inflate. Lightly push air around in the bladders until the corners are free and correctly lined up.
- It is common that the LE will inflate before the struts. If a strut is not inflating, make sure that the air clip is open and the air tube is not pinched or damaged.
- When the kite is fully inflated, remove pump hose and screw the inflation cap back on. Lightly turn/tighten until inflation cap is firmly secured.
- Tighten the lower release valve.
- Do not under-inflate or over-inflate the kite. Proper inflation will make it difficult but not impossible to bend the ends of the kite in. If it is very easy to bend the wing tips in, the leading edge is under-inflated. Your kite should be firm enough that while on its back, the wing tips should extend into the air and the kite should retain its bowed shape. (FIG. A) If the leading edge is under-inflated, it may cause poor performance and re-launching problems. All kites have been tested using 450mB pressure. NOTE: The pumps are rated to 1bar of pressure, however due to wear and tear; pumps can fail at a much lower pressure.
- It is recommended that you isolate the air in your struts. After the kite is inflated, close the clips on the air distribution tubes.
- Once the kite is properly inflated, turn the kite over and secure with sand. (see SETUP TIPS ON SECURING YOUR KITE)

FIG. A



Properly-Inflated Kite



Under-Inflated Kite

SETUP

TIPS FOR SECURING YOUR KITE

- Never leave an inflated kite unattended on the beach for a long period of time. Winds may shift or change and the kite may become unsecured and fly off.
- Always secure your kite with sand, using more weight than you think you need. An unmanned kite is dangerous.
- Never secure your kite with rocks or sharp objects (including your board); they will compromise the life of the kite. If you do not have a sandy beach launch, consider sand bags.
- Do not leave an inflated kite (secured or not), directly exposed to the wind for any length of time. This allows the trailing edge to flutter excessively, which can damage the kite or tangle the control lines. If you must leave the kite exposed to the wind on the beach, place sufficient amounts of sand between each strut and near the trailing edge to minimize or stop the fluttering. Also, if possible, leave the kite in a shaded area.
- Keep in mind other beach users and make sure your kite and lines will not be a danger to others.
- Wind your lines onto the bar when you are not kiting. This will keep the beach free of lines and will prevent other beach users from becoming tangled in your equipment.



DEFLATING THE KITE

The kite may be deflated completely or partially for your convenience. To deflate only the Leading Edge, you must be sure that all the SPRINT™ air clips are pinched closed, thereby isolating each individual strut. Next, unscrew the release valve and not the inflation cap. The release valve is the lower portion of the AIRLOCK. (FIG. A) After deflating, roll up each end of the kite starting at a wingtip and moving towards the center. Clear the valve of any sand or debris; then seal the valve before stowing kite to prevent debris from getting inside internal bladder. To deflate the entire kite, unclip the air clips at each strut. Then unscrew the release valve. This will allow all the air to flow through the leading edge and out of the airlock.

Important: CAUTION

When closing valve on deflated kite, hold bladder in place to prevent twisting the bladder. Do not over tighten valve when kite is deflated. You may tighten it further when kite is partially inflated again.

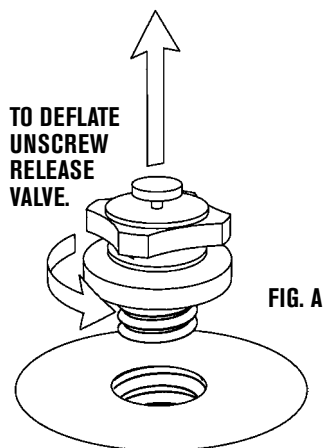

SETUP



PAUSE!

FOR SETUP OF YOUR CABRINHA CONTROL SYSTEM, REFER TO YOUR SUPPLIED CONTROL SYSTEM MANUAL.

IF YOU ARE UNSURE AS TO WHICH CONTROL SYSTEMS ARE COMPATIBLE WITH THIS KITE, PLEASE REFER TO THE KITE/CONTROL SYSTEM COMPATIBILITY CHART AVAILABLE ONLINE AT WWW.CABRINHAKITES.COM.

TUNING

TUNING

The Crossbow IDS offers 2 settings for bar pressure and turning impulse. This is dependent on the attachment position of the rear line bridle.

FRONT Position

Moving the rear bridle to the Front setting increases the bar pressure and turning impulse. It will also shorten the reach required to depower the kite .

BACK Position

Moving the rear bridle to the Back setting will decrease the bar pressure and turning impulse. It will lengthen the reach required to depower the kite.

When moving the rear bridle from the the front or back setting, you must move both attachment points in unison.

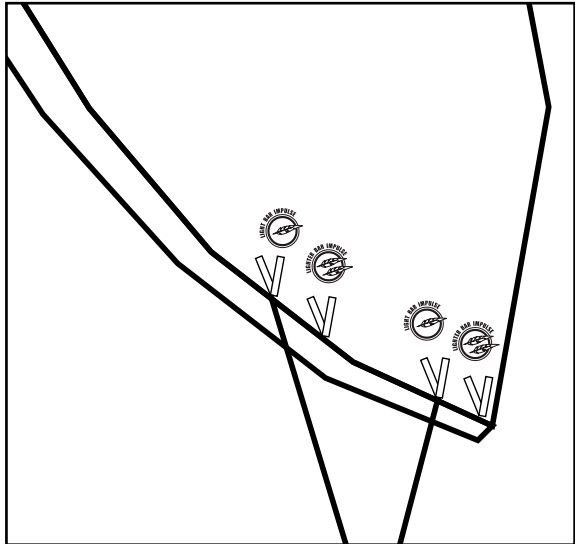

REPAIRS

Major Tears

For a major tear in the kite fabric, consult your dealer for a reputable kite repair loft. To find a Cabrinha dealer in your area, please go to: http://www.cabrinhakites.com/where_to_buy/dealer.html

Minor Tears

For a minor tear in the kite fabric, you may repair the tear with kite repair tape. Your kite has been supplied with an adhesive kite repair material.

1. Clean and dry your kite.
2. Lay the kite flat on a clean, dry, smooth surface.
3. Cut two pieces of repair tape the same size, making sure they are each big enough to cover the entire tear.
4. Carefully cover one side of the tear with a piece of the repair tape. Gently rub the tape smoothly onto the surface of the kite.
5. Next, cover the opposite side of the tear with the second piece of repair tape, in the same manner as before.
6. Make sure the tape is secure.

REPAIRING STRUT BLADDERS

Key Points to Remember

- Before attempting to repair one of your kite bladders, make sure your kite is clean and dry. Always keep your kite pump, valves and bladders free of sand, water and other things that will dirty them.
- Make sure the bladders are deflated.
- Avoid repairing your kite on the beach or in dirty, dusty, windy, or abrasive areas. It is best to find a clean, dry spot out of the wind. A grassy spot is ideal.
- You will need a set of flying lines and a bladder repair kit (supplied with kite) before you begin to repair the bladder.
- Keep track of all valve parts for later use.

1. First, lay the kite out flat with the struts facing up.
2. Detach the Velcro closure at the end of the damaged strut. This will open up the sleeve of the strut and will allow you access to the internal bladder. (Fig. 1)
3. Next, separate the Sprint™ inflation tube from the LE Sprint™ valve at the affected strut by removing the tubing lock collar (LE valve) (Fig. 3).
4. Slide the air clip off of the tube (Fig. 4).
5. Remove the screws (2) from the base of the strut valve (Fig. 5). Keep track of the valve parts for later use.
6. Tie one flying line around the valve. Cinch it down well on the valve.
7. Gently insert the valve/tube down into the strut sleeve.
8. Go to the base of the sleeve and gently pull the bladder out of the sleeve. Detach the flying line and leave it in the sleeve. Having the flying line through the sleeve will allow you to easily replace the bladder once it is repaired.

SEE NEXT PAGE FOR FIG. 4-7



FIG. 1



FIG. 2



FIG. 3

REPAIRS

9. Slide the air clip back onto the inflation tube. Inflate the bladder and clamp the tubing so that it maintains air. Do not over inflate the bladder.
10. Submerge the bladder in water to locate the hole. A bathtub or large sink full of water is best.
11. Look for bubbles to locate the hole.
12. Once you have located the leak, dry the area and mark the hole with a circle. A permanent marker works best for this. (FIG. 6)
13. Dry and clean the rest of the bladder with a soft towel.
14. Again, deflate the bladder.
15. Decide whether to use the glue or a patch supplied in your bladder repair kit.
16. If the hole is on a seam, you will need to glue the area.
17. If the hole is on a flat area of the bladder, remove the backing on one of the patches and press it onto the bladder, covering the hole.
18. Set the bladder aside for approximately 20 minutes to dry.
19. Again, inflate the bladder and check to make sure it is now holding air.
20. If you have repaired the holes in the bladder, coat the entire bladder in talcum powder to assist insertion back into the sleeve. (OPTIONAL)
21. Deflate once again.
22. Tie the flying line from the end of the strut opening onto the valve.
23. Lay the bladder flat at the end of the strut, so that you may now feed it back into the sleeve.
24. Gently feed the valve, followed by the rest of the bladder, into the sleeve.
25. From the valve opening of the sleeve, you will pull the flying line out of the sleeve, while pulling the bladder back into place.
26. Once the bladder is replaced, pull the valve back into the hole of the sleeve and remove the flying line from its base. FIG. 7
27. Inflate the strut partially to make sure the bladder fits into all four corners of the sleeve.
28. Attach the Air Distribution tube and clip connected to the LE.

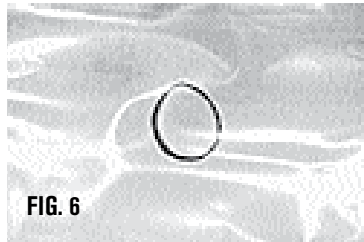

REPAIRS

REPAIRING LEADING EDGE BLADDERS

1. First, lay the kite out with the struts facing up.
2. Each end of the Leading Edge (LE) bladder is folded over and secured with a Velcro closure. You will also find a zipper access pocket at the center of the LE. Undo each Velcro closure and unzip the center access pocket. This will open up the sleeve of the strut and will allow you access to the bladder. (Fig. 1,2)
3. Separate the Airlock Valve Assembly from the leading edge. Carefully lift the retainer ring from the bladder. Using the small pull tab on the Velcro ring, carefully peel the Airlock base off of the inside of the LE. Keep track of the assembly for later use. (Fig. 3,4,5)
4. Next, disassemble the Sprint™ valves. Remove the tubing lock collars of the strut valves (Fig. 6).
5. Slide the air clips off of each tube. (Fig. 7).
6. Remove the screws (2) from the base of each LE valve. (Fig. 8).
7. Keep track of the valve parts for later use.
8. For the next step, you will need two flying lines. Starting with one end of the leading edge, tie one line around the wing tip end of the bladder. Cinch the line down well. Using the second line, follow the same procedure with the other end of the leading edge bladder.
9. Next, gently push the valves down into the strut sleeve.
10. Now, access the leading edge bladder through the zippered access pocket near the leading edge valve. (Fig. 2)
11. Gently pull one side of the bladder out of the sleeve at a time, leaving the flying line through both sides of the sleeve. Having the flying line through the sleeve will allow you to easily replace the bladder once it is repaired.
12. Once out of the sleeve, attach the air clips. Inflate the bladder and close all clips and the airlock valve so that it maintains air. Do not over inflate the bladder.
13. Submerge the bladder in water to locate the hole. A bathtub or large sink full of water is best. You will need to submerge one section of the bladder at a time in order to locate the hole. Look for air bubbles to locate the hole.
14. Once you have located the leak, dry the area and mark the hole with a circle. A permanent marker works best for this. (Fig. 9)
15. Dry and clean the rest of the bladder with a soft towel.
16. Again, deflate the bladder.
17. Decide whether to use the glue or a patch supplied in your bladder repair kit.
18. If the hole is on a seam, you will need to glue the area.
19. If the hole is on a flat area of the bladder, remove the backing on one of the patches and press it onto the bladder, covering the hole.

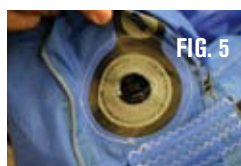
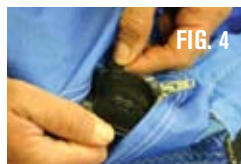

REPAIRS

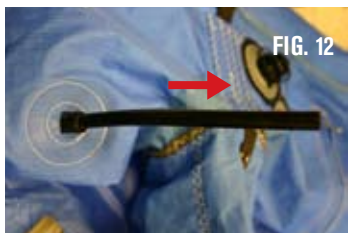
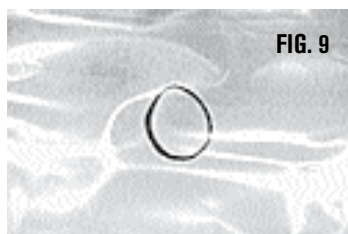

20. Set the bladder aside for approximately 20 minutes to dry.
21. Again, inflate the bladder and check to make sure it is now holding air.
22. Deflate once again.
23. Tie each flying line to the corresponding ends of the bladder.
24. Lay the bladder flat near the center access pocket and fold it, accordion style, so that you may feed each end back into the sleeve without twisting the bladder.
25. Starting with one end, feed the bladder into the access pocket.
26. Walk to one end of the leading edge and gently pull on the flying line, while holding the end of the sleeve. Slowly feed the bladder back into this side of the sleeve. (Fig. 10)
27. Next, follow the same instructions with the other side of the bladder, until the valves are near the holes and the bladder is fully inserted.
28. Tuck the ends of the bladder into the corresponding tips.
29. Once the bladder is replaced, pull the valves back into the holes of the sleeve. (Fig. 11)
30. Next, place the Sprint™ valves back into position. (Fig. 12)
31. Making sure not to catch the internal bladder in the zipper, close the center LE zipper pocket. Next, fold over wingtip access pockets and secure the Velcro strips.
32. Re-attach the Airlock Valve Assembly.
33. Partially inflate the Leading Edge to make sure the bladder fits into all four corners of the sleeve.
34. Reassemble the Sprint™ valves and connect the air distribution tubes to each strut.

GLOSSARY

FREQUENTLY USED KITEBOARDING & WIND TERMINOLOGY

A

ABSOLUTE DEPOWER

Absolute Depower is a built in function of IDS which allows the rider to self land a kite on the water or land.

AIR DISTRIBUTION TUBES

Tubes that connect the LE bladder to the strut bladders.

AIRLOCK - a 2 part valve that allows a single point for inflation and deflation of the kite.

AIR CLIPS

Clips that prevent air transfer between the LE and the struts.

B

BAR (unit) - A unit of pressure

- 1 bar = 14 PSI
- 1 mbar = 0.015 PSI

PSI - A unit of pressure. Pounds per square inch

- 1 PSI = 68.9mbar

BEAUFORT SCALE

A system for estimating wind strength based on the effects wind has on the physical environment (e.g. the behavior of waves, smoke, etc.). Instruments are not used to determine wind strengths in this point scale (0 = calm to 12 = hurricane).

BODY DRAGGING

This is an instructional tactic / step in which the rider flies the kite while in the water, but without the board. The rider will launch, then walk to the water, and basically drag in the water while practicing flying, re-launching and self-rescue techniques.

BLADDER

The inner inflatable tube found within the leading edge and the struts of the kite. (Imagine a bike-it has both a tire on the outside and an inner tube which holds air).

BRIDLES

The lines that hang from the wing tips and leading edge of the kite. The flying lines will be attached from the control bar

to these bridle lines in order to connect control bar to kite.
Tow Points - The attachment points for the bridle.

BYPASS™ LEASH SYSTEM

An optional security leash feature that is recommended for first time users and kiteboarding schools, and for riders who kiteboard without being hooked into the harness loop.

C

CENTERLINE ADJUSTMENT STRAP (CAS)-

Used to depower the kite by changing the relationship between the front and back line lengths. It is also used to position the bar closer to the rider.

CONTROL BAR

The steering device the rider uses to steer the kite.

D

DE-POWER LINES

The two center flying lines that attach to the leading edge bridles on the kite-one to the left wing tip, the other to the right wing tip. These lines assist in de-powering the kite.

DOWNWIND

The direction in which the wind is traveling.

F

FLYING LINES

A term used to describe all four of the lines included with your kite package. These lines connect the bridle lines on the kite to the leader lines on the control bar and are typically 20-30 meters in length.

G

GUSTY WIND

Wind is inconsistent and varies considerably from one wind strength to another.

GYBING

The motion in which the rider changes the direction of the board he/she is riding. The rider switches from a starboard tack to a port tack or vice versa.

GLOSSARY

H

HARNESS

A piece of equipment used to temporarily attach the rider to the control bar harness line. This enables the rider to save energy by utilizing their body weight and all of their muscles to hang on to the kite. Most common are the waist harness (attaches around the torso) and the seat harness (attaches to the waist and around the legs).

I

IDS

IDS is a simplified bridle and control system that seamlessly provides 2 stages of depower.

INFLATABLE KITE

A kite with inflatable tubes designed to float the kite and to facilitate water re-launchability.

K

KITEBOARDING

The term used to describe the sport of power kiting on water or snow.

Kitesurfing

Another term used to describe the sport of power kiting on water.

KNOTS

A measure of speed based on nautical miles.

1 knot = 1 nautical mile per hour.

1 knot = 1.15 miles per hour.

1 knot = 1.85 kilometers per hour.

L

LANDING

The action which places the kite on the water or on land.

LAUNCHING

The motion in which the rider steers the kite from their partner's hands into the sky.

LEADER LINES

The lines that attach directly to the control bar. You will attach these lines to the flying lines in order to connect them to your bar.

LEADING EDGE (LE)

The front inflated tube of your kite.

LEEWARD

The downwind side of the kiteboarder.

LOFTING

Lofting occurs when the kite is above the riders head in the neutral position. Instability in the wind can cause sudden vertical force and lift a rider off of their feet.

LUFF

A term used to describe what happens to the kite in a lull.

LULL

A term used to describe wind when it lessens in strength, for any amount of time. A term also used to describe the complete de-powering of a kite.

M

MPH

Miles Per Hour. A measure of speed.

1 mph = 1.6 kilometers per hour.

N

NEUTRAL POSITION

This is the position just above the rider's head in the sky. If the rider levels out the bar, the kite will gravitate to the neutral position. However, it is difficult and dangerous to keep the kite in this position. Although in this position the kite may feel steady and may feel like it has the least amount of power or pull, it is also the position in which on land the rider is most susceptible to lofting. On the water, the neutral position can be utilized to rest while you reel in your board, but on land, we strongly suggest you do not utilize the neutral position. After launching, it is best to make your way to the water without delay. Do NOT linger on land with the kite in neutral position. It is VERY dangerous.

NEUTRAL ZONE

This is the area that includes the neutral position and the area to the left and right of the rider. It encompasses the most upwind or windward positions in which to fly the kite. When flown here, the kite has less power or pull than when it is in the power zone. However, use caution when the kite is in this zone, especially when on land, and especially in gusty wind conditions.

GLOSSARY

O

OFFSHORE

Wind is blowing from the shore directly or to a great extent out to the water. Do not operate your kite in or near water in this wind direction.

ONSHORE

Wind is blowing directly or to a great extent directly from the water toward the land. Do not operate your kite in or near water in this wind direction.

OVER-POWERED

A situation in which the rider has a kite too powerful for his/her ability level, weight, strength, and/or wind conditions.

P

PLANING

The point in time in which the rider gets the board skimming on the water.

POWER ZONE

This is the area in front and to the sides of the rider, but excluding the neutral position and zones. It is the area in which the kite has the most power and pull. When flown in this area, the kite can be powerful and dangerous, so avoid flying your kite in this zone when learning. Use extreme caution when flying the kite in this zone.

PUMP – Device used to inflate the kite.

Q

QRS-QUICK RELEASE SECURITY SYSTEM

A quick release point on the control system which, when activated, detaches the control system from the harness loop. Also referred to as the Main QR.

QR2

A secondary quick release on the harness loop, which, when activated, separates the landing line from the harness loop. Thus separating the kite from the rider.

R

REACH

A direction of travel relative to the wind direction. Generally 90-160 degrees off the wind.

RE-LAUNCHING

The motion in which the rider steers the kite off of the water and back into the sky.

S

SELF LAUNCHING

A technique in which the rider launches the kite without assistance, usually by weighting down a wing tip with sand until he/she is ready to launch.

SIDE OFFSHORE

Wind is blowing from either the left or the right and from the shore out to the water. This is a combination of offshore and sideshore wind. Do not operate your kite in or near water in this wind direction.

SIDESHORE

Wind is blowing from the left or from the right, parallel to the shore. Ideal wind direction for kiteboarding.

SIDE ONSHORE

Wind is blowing from either the left or the right and from the water toward the land. This is a combination of onshore and sideshore wind. Utilize caution when operating your kite in or near water in this wind direction.

SPRINT™

Single Point Rapid Inflation Technology.

STEERING LINES

The two outside flying lines that attach to the trailing edge bridles on the kite—one to the left wing tip and the other to the right wing tip.

STRUTS

The outer fabric tubes found on your kite. They house the inner inflatable bladders, which are filled with air to give structure to the kite.

GLOSSARY

T

TRAINER KITE

A kite that may be used on land to simulate the motions used in kiteboarding. It is an excellent instructional and learning tool. Despite its small size, this kite still has power, so be alert.

U

UNDER-POWERED

A situation in which the rider has a kite not powerful enough for his/her weight, strength, and/or wind conditions.

UPWIND

The direction from which the wind is blowing.

W

WATER STARTING

The motion of the rider in which he/she goes from sitting or lying in the water to standing on the board.

WINDWARD

The upwind side of the kiteboarder.