

WARNING

DO NOT USE THIS PRODUCT UNLESS YOU HAVE READ AND UNDERSTAND THESE WARNINGS, CAUTIONS, AND INSTRUCTIONS WHICH ARE FOR YOUR SECURITY AND PROTECTION. THIS INFORMATION MAY BE SUBJECT TO CHANGE AT ANY TIME. FOR CURRENT UPDATES, PLEASE VISIT OUR WEBSITE AT: WWW.CABRINHAKITES.COM

IF YOU ARE BELOW THE AGE OF 18, YOU SHOULD HAVE YOUR PARENT OR GUARDIAN READ THESE WARNINGS, CAUTIONS AND INSTRUCTIONS AND SHOULD NOT USE THIS PRODUCT UNLESS YOU ARE UNDER THE PROPER GUIDANCE AND SUPERVISION OF SUCH A PERSON.

The use of this product exposes the user to many unavoidable and unexpected risks, injury, DANGERS and HAZARDS. The suppliers of this product are not responsible for any damage to property or any personal injury caused by any use, misuse, abuse or irresponsible use of this product by the user.

Kiteboarding is a HAZARDOUS sport. Power kites and their lines and control equipment can be DANGEROUS to flyers and to anyone in the vicinity of their use. Kiteboarding must be taken seriously and we recommend that, at least in the early stages of your use, you seek the guidance of professional instructors and experienced kiteboarders. Improper and/or unreasonable use of this kite may result in DEATH or SERIOUS INJURY to ANY part of your body and to OTHERS. Do NOT use your kite near power lines, airports, buildings, automobiles, trees, streets, parking lots, rocks, piers, breakwaters, buoys, etc. and keep your kite fly lines away from people and ALL obstacles. Always fly in an open area and observe wind and weather conditions, particularly in circumstances where you may encounter offshore, onshore, variable or strong winds. Do NOT attempt to use your kite on water until you are confident and comfortable with the use of a trainer kite on land. Spend time to become familiar with the operation of your kite and remember that you are responsible for its operation and for the security of those around you. As you learn the sport, work within your own limitations and do NOT exceed them. If you intend to use the kite on water, always use appropriate protective gears and flotation devices and do NOT attach yourself or tie yourself permanently to the kite lines. The kite is NOT intended for use as a flying device nor indeed is it intended as a means of flotation.

...continues to next page

WARNING

RECOMMENDED KITEBOARDING PRACTICE:

Kiteboarding is an extremely diverse sport, with many disciplines and ability levels. As with all sports, there can be certain inherent risks. The following contains key security points to remember when operating your Cabrinha kite.

- Kiteboarding is a HAZARDOUS activity and the use of Kiteboarding equipment involves the risk of serious personal injury to any part of the user's body or death.
- Injuries are an INHERENT RISK of kiteboarding and the participation in kiteboarding implies the user's acceptance and assumption of those risks.
- Children should ALWAYS be under adult supervision.
- It is strongly recommended that beginners take lessons.
- ALWAYS inspect your equipment for signs of wear and tear each time before use, particularly all lines, canopy, bladders, screws and fittings.
- If ANY products are found to show signs of wear & tear, STOP using the product immediately and repair or replace before further use. If in doubt about any signs of wear & tear, please contact your local vendor. Contact details are available from www.cabrinhakites.com
- NEVER place yourself in a situation where breakage of any one of the various kiteboarding components would pose a risk to yourself or others, or make it difficult to return to the shore securely & unassisted.
- Make sure you use properly designed and manufactured parts from reputable suppliers.
- Take time to study the conditions including sea state, tides, currents, weather conditions and forecasts before you decide to go sailing. Beware of sailing in offshore, onshore, variable or strong winds.
- Familiarize yourself with any new location before venturing onto the water. Ask the locals to tell you about any hazards.
- Watch out for other beach users, especially swimmers and small children. Make sure you keep your board and rig under control at all times and that they don't get blown about on the beach or in the water.
- Always use appropriate protective gear and flotation devices. Wear the correct protective clothing for the conditions such as a wetsuit or a UV top.
- We STRONGLY recommend wearing a kiteboarding specific helmet
- Make sure someone knows where you've gone & when you are expected back – always sail with a buddy.
- Be aware of the conditions as they change. ALWAYS return to the beach if there is a significant change in the conditions. i.e. wind dropping or wind & waves increasing.
- As you learn the sport, work within your own limitations and do NOT exceed them.
- Do NOT alter, modify or change this product.
- This product is designed and manufactured only for kiteboarding on water or snow.
- Keep these warnings, cautions and instructions for future reference.
- The following contains key security points to remember when operating your Cabrinha kite, and associated kiteboarding equipment on water, land or snow.

WARNING

SNOW USE GENERAL GUIDELINES

- The points listed under the Recommended Kiteboarding Practice also apply to the use of this product on the snow. Please read the previous paragraphs even if you intend to use this product primarily on the snow.
- These kites are intended for use on the snow as a traction device to propel a rider across wide open snow fields in a controlled and appropriate manner.
- Do NOT attempt to use this kite as a flying device. Do NOT use this kite to soar from ridges, cliffs or slopes.
- Do NOT attempt to launch yourself into the air in any manner which can create excessive impact to the rider upon landing.
- EXTREME caution must be taken when using this kite in any mountainous region, uneven terrain or glacier. Wind conditions in these areas are notoriously unstable and can change in velocity and direction without notice.
- ALWAYS use appropriate protective gear. We STRONGLY recommend wearing a snowboarding specific helmet.
- Do NOT tether yourself to any stationary or moving object such as a stake, snowmobile, or car while flying this kite.
- ALWAYS stay in control and be able to stop or avoid other people or objects
- SNOWKITE: People downwind or down slope have right of way. It is your responsibility to avoid them
- SNOWBOARD: People down slope have right of way. It is your responsibility to avoid them
- You must NOT stop where you obstruct others or are not visible.
- Whenever starting or merging with others look upwind/up hill and yield to others.
- Always use retention devices while riding to help prevent runaway equipment. If you remove the retention device for any reason, turn snowboard upside down and push the bindings into the snow to prevent runaways.
- Observe any and all posted signs and warnings
- Keep out of closed areas
- SNOWBOARD: Prior to using any lift you must have the knowledge and ability to load, ride and unload safely.
- Do NOT snowboard/snowkite when tired or under the influence of alcohol or drugs.
- Snow terrain and snowboarding/snowkiting conditions VARY CONSTANTLY--AVOID ANY man made structures, trees, tree-wells, rocks, debris, variations in terrain or slopes, avalanche areas, crevasse, cliffs, power lines, lift lines, water hazards, changes in snow surfaces or texture due to altitude and sun exposure, wind and weather changes, and any other conditions which could affect your ability to properly control your snowboard/snowkite.



QUICKLOOP 1X

- 2 Introduction
- 3 Important Information
- 4 Wind, Water, & Weather Conditions
- 5 Know Your Ability Level/Kiteboarding Location
- 6 Kite Care
- 7 Beach Etiquette
- 8 Area of Operation

QUICKLOOP 1X WITH OVERDRIVE

- 9 1X With Quickloop
- 10 OVERDRIVE 1X With Quickloop

SETUP

- 11 Check Your Line Lengths
- 12 Line Length Corrections
- 13 Downwind Launch Setup
- 14 Upwind Launch Setup

OPERATION

- 15 Quick Release System
- 16 Security Pin
- 18 BYPASS™ Leash
- 19 Centreline Trim System

- 20 Security Line
- 22 Overdrive Bar Adjustment

- 23 Steering
- 24 PAUSE
- 25 Launching
- 26 Landing
- 27 Relaunching
- 28 Tuning
- 29 Glossary

INTRODUCTION



Thank you for purchasing this Cabrinha product and welcome to the sport of kiteboarding. As you may know, the excitement of Kiteboarding is attracting people of all ages from all corners of the globe. It's one of the most dynamic and fastest growing sports in the world.

CAUTION:

Kiteboarding can be overwhelming if not approached in an educated manner. That's why we have supplied this extensive user's manual. It will help to educate you about your new kite and about the ways in which to use it. It contains information regarding the setup, care and maintenance of your control system. Please note that only compatible Cabrinha kites will benefit from all of the security and performance functions associated with this control system. Consult www.cabrinhakites.com for a list of compatible kites for use with this Control System.

Please read this user's manual carefully and entirely before using this kite. This manual is not intended to replace proper kiteboarding instruction, but rather to supplement it. Do not attempt to kiteboard without appropriate instruction. It will make this sport more enjoyable, not only for yourself, but for those around you.

IMPORTANT INFORMATION

Kiteboarding is a hazardous sport, with many disciplines and ability levels. As with all sports, there are inherent risks of injury. The following contains key points to remember when operating your Cabrinha kite.

- Be familiar with the set up and use of the supplied security systems: Overdrive 1X and the Harness Loop Quick Release systems.
- Make sure your control system is rigged and used according to the supplied instructions.
- Make sure your kite is compatible with the control system.
- Always use your Cabrinha kite with a bypass leash.
- NEVER permanently attach yourself to this kite, the control bar, or lines.
- NEVER use this kite as a flying device.
- NEVER touch the kite lines while they are under tension; do not catch the kite using these lines.
- When inflated but not in use, secure your kite with sand or with something heavy and non-abrasive; the more weight the better (see "Kite Care" for more information). An inflatable power kite will still fly, even without a rider, so be mindful of those around you and secure your kite. Your kite may cause serious injury or death if it launches unexpectedly.
- Do not lend your gear to someone who has not been fully instructed on the use of inflatable kites. Other users should also read this user's manual and be proficient in all its points.
- Check your gear before going on the water. Insure that your flying lines, security systems, kite, board, etc. are all rigged properly and are in working order.

PROTECTIVE GEAR

We strongly recommend the use of the following protective gear:

- Kiteboarding specific helmet
- Life Jacket, Impact Vest, or Flotation Vest
- Neoprene Wet Suit
- Gloves
- Foot Protection
- Eye Protection
- Knife
- Sunscreen

IMPORTANT INFORMATION

WIND, WATER, AND WEATHER CONDITIONS

- Do NOT under estimate the power of the wind.
- Be aware of unpredictable and changing weather conditions.
- Avoid "offshore" or "onshore" wind conditions.
- Avoid strong, gusty wind.
- Be careful of wave conditions, especially when learning.
- Be educated about tides and rip currents.
- Be mindful of your ability level. Do NOT kiteboard if conditions are beyond your ability level.
- Be educated about air and water temperatures and wear appropriate protection against the elements.
- Do NOT use this product in thunderstorms.
- Consult an anemometer and weather stations to determine wind speeds if necessary.
- Do NOT use an oversized kite. Consult your Wind Range Chart for the correct recommended size. Use your common sense. If in doubt about what kite size to use, choose smaller rather than bigger.
- Make certain that you are physically capable of operating the security Quick Release (QR) and 1X devices provided with this kite. This kite and control system has been designed around a typical rider weight of 40 to 110kg.

Riders with a weight greater than 110kg may need to use more force to operate the QR than lighter riders. Increases in wind strength may also result in greater force being required to operate the QR. Be certain to seek the advice of a professional such as your Authorized Cabrinha Dealer about the performance of the security systems in relation to body weight.

IMPORTANT INFORMATION

KNOW YOUR ABILITY LEVEL

- Do NOT attempt kiteboarding without appropriate instruction.
- Do NOT kite alone.
- Launch, land, and ride together with a partner or have someone on shore who can keep an eye on you.
- Make sure you are in good physical condition before using this product.
- Practice flying a small, traction kite or a “trainer kite” before flying this kite.
- The more time spent on the “trainer kite”, the faster you will learn.
- Make sure you are a proficient swimmer before using this product in or near the water.
- Make sure the wind and water conditions are within your ability level and that you have made the correct equipment choices.
- NEVER kiteboard further from shore than you are reasonably able to swim back.
- ALWAYS save a reserve of energy; end your kiteboarding session before you are exhausted.
- Make sure you've done your homework and that you know the security precautions of all aspects of the sport: rigging, Launching, landing, flying, riding, kiting among other water users, self rescuing, etc.
- Understand and practice operating your security systems before ever launching your kite.
- Understand the technique of self-rescue before using this product in or near the water.
- NEVER let someone who is not familiar with inflatable kites launch, catch, or use your kite. You will endanger them, as well as yourself and those around you.
- You are responsible for the proper operation of your kite.

KITEBOARDING LOCATION

- Observe ALL local laws and regulations regarding this product and the usage area.
- Talk to the local riders about the weather conditions and beach rules.
- Check your area thoroughly before launching your kite.
- Make sure you have considerable space in which to launch, land, and use this product.
- You should have at least 100 meters of space from all objects on both sides and downwind of you. Be especially aware of your downwind area.
- Be mindful and aware of the wind direction in relation to your launch area.
- Avoid areas with rocks and/or shallow or exposed reefs.
- Be mindful of tide changes. As water levels change, you may be exposed to new obstructions.
- Avoid launching, landing or using this product near power lines, telephone poles, trees, people, pets, buildings, automobiles, streets, sharp objects and airports.
- Avoid crowded beaches and waterways.
- Make sure your lines do not cross a walkway or passage.
- Do NOT let others walk between you and your kite.
- Be careful and mindful of other water users, including windsurfers, boaters, jet skiers, swimmers, floating objects, etc.
- Before launching, make sure you have scouted a backup landing area, in case you do not make it back to your launch spot.

IMPORTANT INFORMATION

KITE CARE

Due to the often extreme nature of kiteboarding, a thorough approach should be taken when caring for your kite and all its associated rigging, as well as your protective gear.

PREPARING FOR YOUR SESSION

- Thoroughly check your protective equipment (helmet, etc.) to make sure it is in working order and in good condition.
- A frequent inspection of the kite and the control system should be made in order to identify punctures, tears, or abrasions in the canopy, struts, or security systems. It is also necessary to check the fly lines for wear and for unwanted knots, which may reduce the strength of the fly lines. Check bridle lines and pulleys for wear and replace when necessary.
- Do NOT rig on asphalt, cement, gravel, or other abrasive surfaces; doing so may damage your equipment. It is best to rig on sand or grass. Damage done to your equipment by rigging on abrasive surfaces will not be covered under warranty.
- Do NOT rig among sharp objects that could tear the canopy or puncture the struts and leading edge bladder.
- Take care NOT to expose your flying lines to sharp objects that may wear through them.
- While setting up, secure your kite with sand or sand bags. Do NOT secure your kite with rocks or other sharp or abrasive objects that may damage your kite.

BETWEEN SESSIONS

- NEVER leave an inflated kite unattended on the beach for a long period of time. Winds may shift or change and the kite may become unsecured and fly off.
- Do NOT leave an inflated kite (secured or not) directly exposed to the wind for any length of time. This allows the trailing edge to flutter excessively. Any excessive fluttering may quickly break down the

finish properties of the material and reduce it's longevity. If you must leave the kite exposed to the wind on the beach, place sand or sand bags onto the areas of the kite, near the trailing edge until the flutter is stabilized. Do not use rocks or other sharp objects.

- Do NOT leave your kite exposed to sunlight for long periods of time. Between sessions, choose a shaded area to secure your kite. When not in use, stow away.

PROPER STORAGE

- ALWAYS dry your kite prior to rolling or folding. Folding or rolling a kite when wet may affect the color clarity and longevity.
- It is recommended to wash the kite components with fresh water and dry before storing.
- Clear the kite of sand or other foreign objects before stowing.
- Once it is clean and dry, stow your kite in the supplied bag in a clean, dry, cool place.
- Do NOT place heavy objects on the bag containing the kite.
- Do NOT leave your kite inflated in your car or car rack box; exposing the kite to extreme temperatures while inflated may damage the internal bladders.
- Wash your control system with fresh water from time to time by placing the entire control system (with lines wound onto the bar) into a bucket of fresh water and let it sit for 5 minutes. Allow to dry thoroughly before storing in a dry location.
- Once it is clean and dry, stow your control system in a clean, dry cool place.

Here are some basic things to consider when sharing beaches and water accesses with other users:

SAFETY

- Follow ALL of the instructions outlined in this manual, other manuals and installation guides.
- Follow the instructions and rules and regulations posted at the beaches you use.
- Check with local kiteboarding associations and shops prior to launching in a new area. There may be local rules and regulations to follow which are not posted.
- Utilize common sense.
- Do NOT touch other people's gear, unless instructed to do so by the owner. Picking up their bars, kites, etc. may disrupt a setup ritual they have.
- ALWAYS secure your kite with sand or sand bags. An unmanned kite is dangerous.
- NEVER leave an inflated kite unattended. Winds may shift and cause the kite to become unsecured and fly off.

SETTING UP

- Set up only the gear that you plan on using immediately. Deflate and put away your kites when not in use.
- Set up in an area where you have plenty of space.
- Set up in a manner conducive to having multiple users in the area.
- Roll up your lines when not in use.
- ALWAYS keep other beach and water access users in mind when launching, landing, and kiteboarding.
- Yield to other beach users. Be courteous and cooperative.
- ALWAYS be ready to lend assistance to other kiteboarders. The favor may be returned sooner than you think.

IMPORTANT INFORMATION

AREA OF OPERATION

This is the 100 meters of area with no obstacles to each side and downwind of the rider. Do not launch your kite if you do not have this distance between yourself and other people, or obstructions.

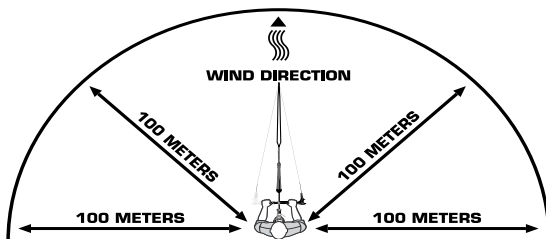

⚠ WARNING

PLANNING YOUR LAUNCH

- Choose an area where you have at least 100 meters of space from all obstacles to your left and right and especially downwind of you.
- Set up your equipment so that your kite is downwind of where you will be launching, but most importantly, so that it is at an angle off of the wind.
- **DO NOT SET UP YOUR KITE FOR A STRAIGHT DOWNWIND LAUNCH!** The kite will launch with too much power and you will endanger the lives of yourself and those around you if you launch in this manner.
- Basically, if the wind is at your back, and straight downwind is at a 180°, then you will want to set your kite at about a 100° off the wind, either to the left or to the right of you.
- The more the kite is positioned into the wind when you launch, the less power it will have when it goes up, and the easier your launch will be.
- Your partner will stand with the kite while you will stand 30 meters away at your control bar.
- Make sure you launch slowly, and launch the kite at an angle, **NOT STRAIGHT DOWNWIND!**

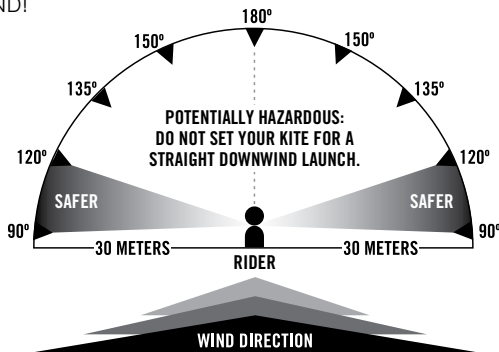

IMPORTANT INFORMATION

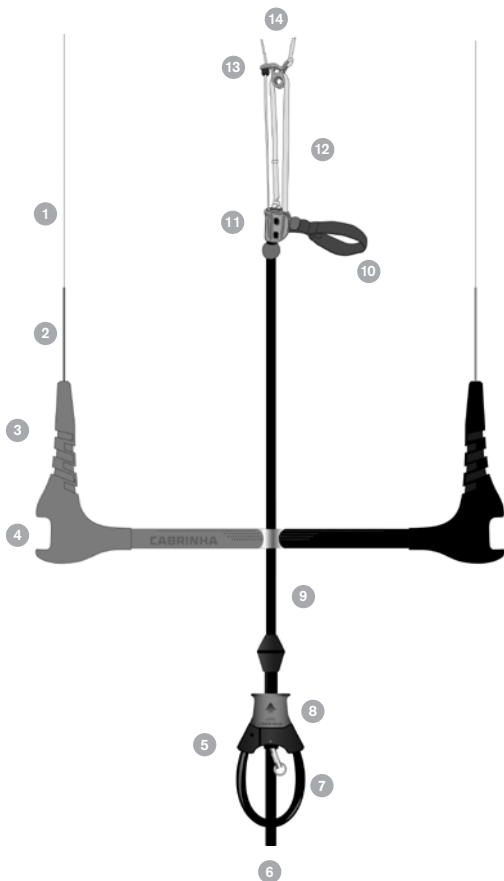

FIXED/CHAOS BAR

- 1) Rear Steering Lines
- 2) Color Coded PU Line Sleeve
- 3) EVA Floating Bar Ends
- 4) Line Winders
- 5) Quickloop Harness Loop
- 6) Removable Security Pin
- 7) Bypass Leash Connector
- 8) Quick Release (QRS)
- 9) Depower Mainline
- 10) Trim Lite Handle
- 11) Trim Lite Cleat
- 12) Trim Line Line
- 13) Trim Lite Power Bracket
- 14) Front Control Lines
- 15) Bypass Leash
- 16) Bypass Leash Quick Release

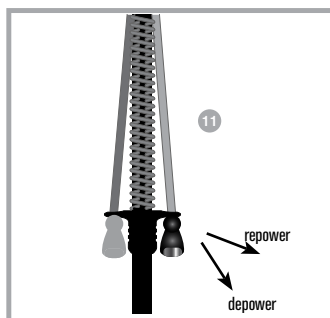
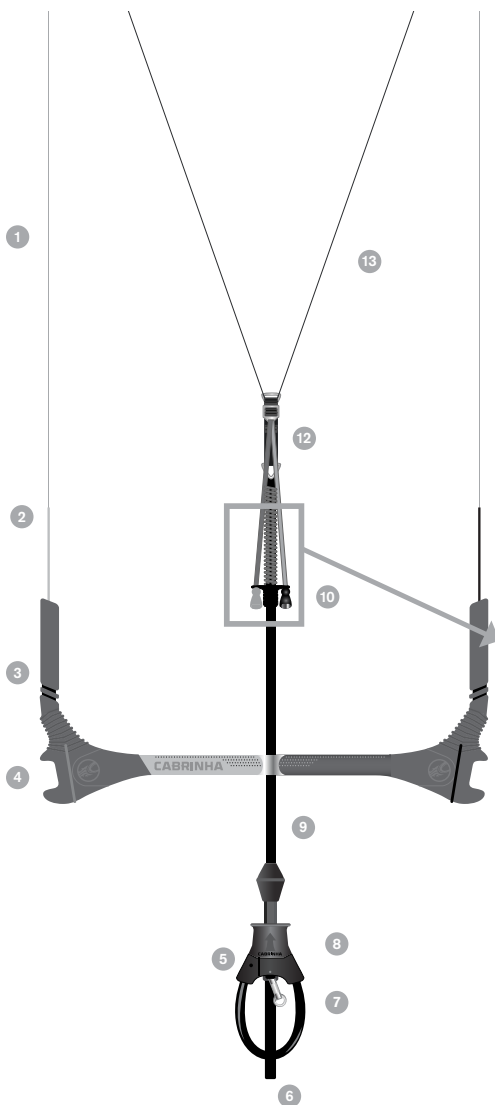

*image not to scale

OVERVIEW

OVERDRIVE 1X WITH QUICKLOOP

- 1) Rear (Steering) Lines
- 2) Color Coded PU Line Sleeve
- 3) EVA Floating Bar Ends
- 4) Line Winders
- 5) QuickLoop Harness Loop
- 6) Removable Security Pin
- 7) Bypass Leash Connector
- 8) Quick Release (QRS)
- 9) Depower Mainline
- 10) Centreline Trim System
- 11) Trim Line
- 12) Security Line
- 13) Front Control Line
- 14) Bypass Leash
- 15) Bypass Leash Quick Release



*image not to scale

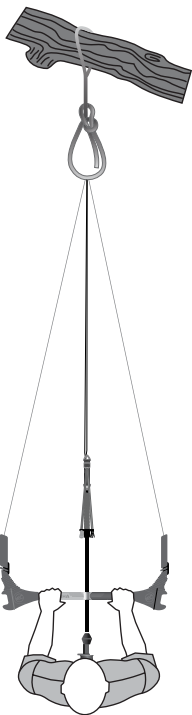

CHECK YOUR LINE LENGTHS

The Cabrinha control bars come set up with the flying lines attached; however, it is wise to check your line lengths before going on the water, and after use. To check the 1X line lengths use the method described below.

- Loop a piece of line (any rope or cord) around a tree or fence post.
- Tie the line in a knot around the tree, leaving a piece long enough to attach all lines.
- Roll out the flying lines from the post and set the control bar on the ground, facing up, with the Orange side of the control system on the left and the black side of the control system on the right. Make sure there are no obstructions in between your bar and the post.
- Make sure your flying lines are not twisted or crossed.
- At the ends of the flying lines nearest the post **you will notice that there are eyelets on the rear steering lines and front de-power lines**. The overhand knots on the front (de-power) lines are there to eliminate incorrect connection to the kite. The eyelet on the front lines is just below the overhand knot. You may need to gently pry the eyelet open on the front line pigtails using the screwdriver in your kite bag. See FIG 1.
- Take the rope attached to the post and feed it through the eyelets on all four lines, with the red on the left and the black on the right. See FIG 2.
- Tie a bowline knot, with all four lines inside the loop.
- Walk back to the control bar.
- Make sure that the centerline adjustment strap/cleat line is fully extended, so that the kite is set up at full power.
- Standing directly in line with the post, pull back hard and steady on the control bar by pulling straight back toward yourself.
- Your control bar should be in line with your shoulders and should be straight and not at an angle.
- All of the lines should have even tension under pressure. (I.e. no slack in the de-power lines, steering lines).
- If your control bar is even, your control system is ready to attach to your inflated kite.

FIG 1

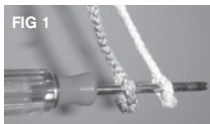

FIG 2



*If your control bar is even, proceed to: **SETUP - INFLATING YOUR KITE***

If your control bar is NOT even, follow the instructions in:

SETUP - LINE LENGTH CORRECTIONS

SETUP

LINE LENGTH CORRECTIONS

The steering adjustments are made at the end of the flying lines where they are connected to the kite.

If one of the flying lines is too long, loosen the larks head loop from the knot, then loosen the knot and move it towards the kite to shorten the line.

If the line is too short, loosen the larks head loop from the knot, then loosen the knot and move it towards the control bar to lengthen the line.

- Re-tighten the knot and check your line length again. Adjust again if necessary until the control bar is balanced.
- DO NOT put knots in your FLYING LINES. Knots in the flying lines compromise the life of the line.

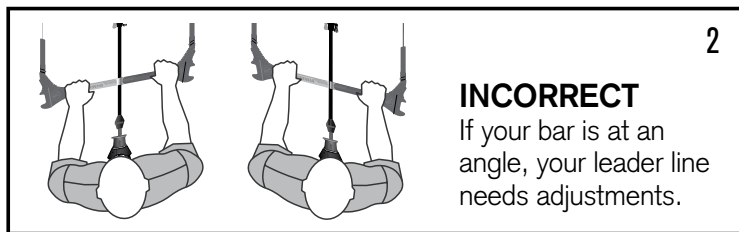
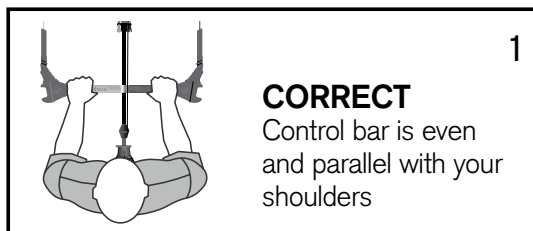
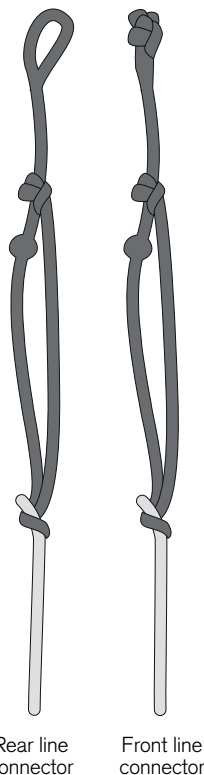

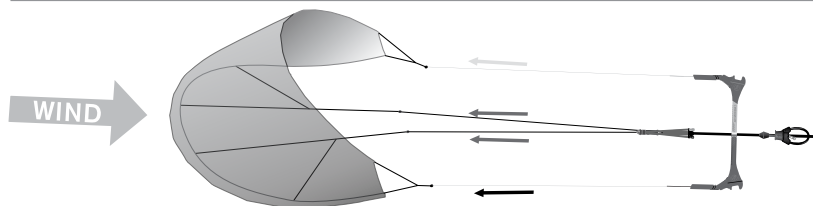

DOWNWIND SET UP (Bar downwind of kite)

- Lay the bar 30 meters downwind of the kite so that the wing tips are facing the control bar (the leading edge of the kite should be facing into the wind). When setting the bar up downwind of the kite, you must turn the bar upside down before walking the lines out. The orange side of the control system should be on the right and the black side of the control system on the left.
- Lay out and clear the bridle making sure all pulleys are cleared of any sand or debris and that they are in good working order.
- Walk out the steering (outside) lines and using a larks head knot, attach them to the middle knots on the rear line attachment points. (FIG 1-3). This setting assumes you've already checked and properly tuned your control system to ensure all 4 flying lines are completely even when the bar is sheeted in to full power.
- Walk out the Center De-Power (center) lines. Attach the centre Line with the 1X Designation to the corresponding front Pigtail connector based on the side you wish to flag out the kite. Connect to the Left side of the kite (same side of the bridle as the Red Rear Pigtail) if you want to flag the kite to the right. Connect to the right side (same side of the bridle as the Black Rear Pigtail) if you want to flag the kite to the left. (FIG 4-6).
- The lines should not cross each other or be twisted.
- Your kite is now ready to fly.

Please see the sections of this manual that relate to safety and make sure you are familiar with the conditions before getting on the water.

REAR (STEERING) LINES



FRONT (DEPOWER) LINES



SETUP

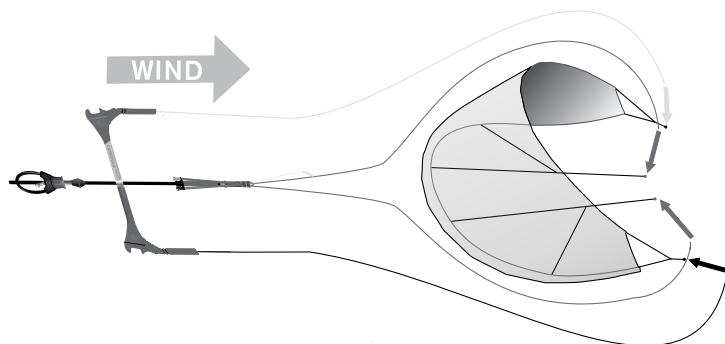

UPWIND LAUNCH SETUP (Bar upwind of kite)

- Lay the bar 30 meters upwind of the kite. The leading edge will be pointed toward the bar and into the wind. The wing tips of the kite will be facing away from the bar. The control bar should be right side up. The orange side of the control system on the left and the black side of the control system on the right.
- Lay out and clear the bridle making sure all pulleys are cleared of any sand or debris and that they are in good working order.
- Walk out the steering (outside) lines and place them parallel to each other on the ground about 4 feet apart near the kite (remember, red-sheathed lines on the left and black-sheathed lines on the right).
- Place the steering lines far apart, so the kite will lie between them.
- Walk out the de-power (center) lines and place them in between the steering lines, parallel to each other, so that all four lines are lined up as follows (left to right). The lines should not cross each other or be twisted.
- Place the kite leading edge down so the wing tips of the kite are pointing downwind and are near the ends of our steering lines.
- Make sure the kite is still secured with sand or sand bags.
- From outside of the kite, attach the steering lines to the corresponding back bridles on the wing tips. Using larks head knots, attach the steering lines to the middle knot on the back bridles. Give each knot a tug to secure. This setting assumes you've already checked and properly tuned your control system to ensure all 4 flying lines are completely even when the bar is sheeted in to full power.
- From the inside of the kite, attach the centre Line with the 1X Designation to the corresponding front Pigtail connector based on the side you wish to flag out the kite. Connect to the Left side of the kite (same side of the bridle as the Red Rear Pigtail) if you want to flag the kite to the right. Connect to the right side (same side of the bridle as the Black Rear Pigtail) if you want to flag the kite to the left. (FIG 4-6).
- Again, double check to make sure that your lines do not cross each other, and are not twisted.
- Your kite is now ready to fly.

Please see the sections of this manual that relate to safety and make sure you are familiar with the conditions before getting on the water. Kite tuning tips are located in this manual under Tuning.



FIG 1

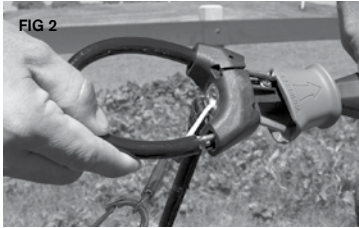

FIG 2



FIG 3



FIG 4

1X WITH QUICKLOOP

QUICK RELEASE SYSTEM (QRS)

You should be familiar with the operation of the QRS in the event of a situation where you wish to activate the QRS feature.

QRS - OPERATION

Grab the release body and firmly push away from your body (in the direction of the arrow) until it meets the bottom of the spinning handle (FIG 1). Activating this primary quick release (QR1) will still leave you attached to your kite via the 1X Security line.

For complete separation from your kite, you will need to activate Quick Release Handle on your bypass leash. This is covered in detail in the Bypass Leash Operation Page 18.

QRS - SETTING / RESETTING

- Lift the QR1 body up the spinning handle shaft until it sits and latches on the side of the QR1 Hinge body. (FIG 1)
- Take the open end of the loop and insert it into the upper receiver section of the harness Loop Body, until it stops. (FIG 2)
- Release the QR1 Body from the Catch.
- Lower the QR1 body back down the shaft until it rests flush with the Harness Loop Body. Do this by straightening out and centering the QR Body to disengage the catch on the side. (FIG 4)
- Your QR System is now ready for use.

OPERATION

SECURITY PIN

The harness loop is the rider's primary connection to the depower system, as long as it is equipped with a security pin. This security pin is active only when the rider is hooked into the harness loop. Therefore, it is important that a secure connection is made between the Harness Hook and the Harness Loop. This critical connection allows you to depower the kite, spin your bar freely, and re-launch your kite easily, all while still being connected to your kite.

- We suggest that you engage the Security Pin only when ready to launch and/or the Bypass Leash is connected.

CAUTION: Be advised that when the Security Pin is engaged, you have a semi-permanent connection to the kite. As a precaution, know where your Quick Release Handle is and be educated on how to activate it before engaging the Security Pin.

SECURITY PIN – ENGAGING

- Double check that your QR and control system are set up properly.
- Hook into your harness loop.
- Once hooked into the harness loop, only engage the Security Pin once you are ready to launch.
- Insert the Security Pin into the center of the harness hook, making sure it is below the harness loop. Your harness loop must be between the harness hook and the Security Pin in order for this feature to work properly. (FIG 1 & 2)
- Make sure that the Security Pin is secure. This will keep your harness loop from accidentally dropping out of your harness hook. Your Security Pin is now ready for use.

SECURITY PIN – RELEASING

With your hands, slide the Security Pin out of the harness hook. (FIG 3)

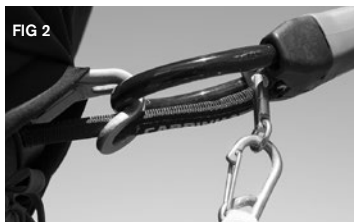

SECURITY PIN REMOVAL

- Using a 2mm Allen Key loosen and remove the Security Pin Screw by rotating in a counter clockwise direction. (FIG 4)
- Pull the Security Pin in a downwards motion (from the Quickloop Body), this may require some force and may need left to right movement. This will remove the Security Pin Metal Brace from the Quickloop Body. (FIG 5).
- Reinsert the Security Pin Screw and tighten into the Quickloop Body to avoid losing it.

SECURITY PIN – CONNECTION

- Using a 2mm Allen Key, loosen and remove the Security Pin Screw.
- Insert the Security Pin Metal Brace into the Cavity on the bottom of the Quickloop Body, until the brace sits fully into the space (FIG 6) This may require some force.
- Using a 2mm Allen Key Re insert the Security Pin Screw and using a Clockwise rotation, tighten.

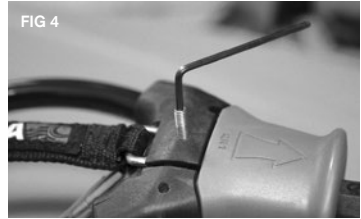

OPERATION

BYPASS™ LEASH

The Bypass Leash QR also acts as a QR2, which after deployment of the QR1 activation of the QR2 will completely separate the rider from the Kite.

Connecting the Bypass™ Leash

- The Carabiner end of the Bypass Leash must at all times, be attached to the Leash Connection Ring, that is attached to the bottom of the 1x Landing Line. (FIG 2)

CAUTION:

To disconnect yourself from the Bypass leash you must activate the QR at the end of the leash by pushing the QR away from your body (FIG 3-5).

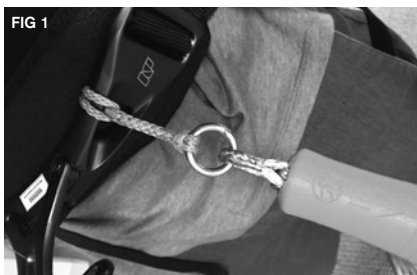

FIG 2



FIG 3

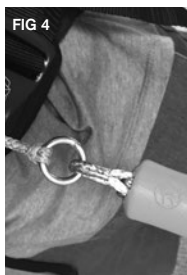

FIG 4

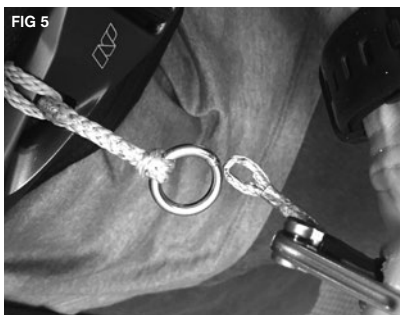
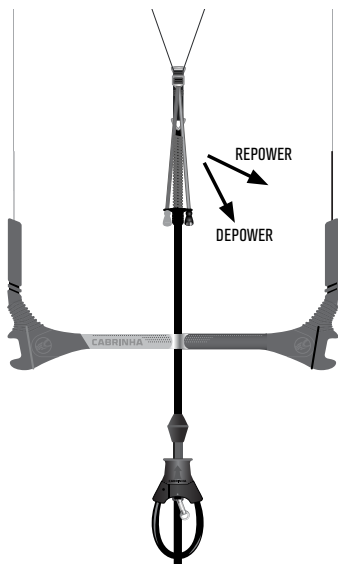

FIG 5

Disconnecting from your kite may cause your kite to blow downwind unaccompanied. Avoid at all costs, disconnecting in a situation where your loose kite may endanger others. Disconnecting from your kite at sea may also mean the possibility of not being able to retrieve your kite. Use extreme caution and judgement when disconnecting from your kite. Familiarize yourself with the operation of the QR and all security systems prior to using this equipment.



Both the CAS (Centreline Adjustment Strap) found on the Overdrive Bars, and the Trim Lite Cleat System found on the fixed bars, effectively change the length of your front lines (referred to as trim).

By pulling on the CAS Orange Handle, or the Trim Lite Webbing handle you shorten the line (depowers the kite slightly). To repower the kite you need to lengthen the front lines by either pulling on the CAS Black Handle, or by releasing the Cleat Line from the Trim Lite system.

CENTERLINE ADJUSTMENT STRAP (CAS)

- Pull on the Orange T Handle to depower.
- Pull on the Black T Handle to re – power.

NOTE: The CAS is meant to provide a limited amount of trim and is not to be confused with, or used in place of the 1X depowering function (see next section).

TRIM SYSTEMS.

To Depower:

- Pull the webbing handle towards your body, until the required trim is reached. (FIG 1)
- When desired trim is reached pull the handle down in parallel to the Depower Mainline to set the line in the cleats teeth. (FIG 2)

To Re-Power

- Pull the Webbing Handle towards your body to release the line from the cleat. (FIG 1)
- Lift the rope outwards slightly so that the Trim line is free from the cleats teeth. (FIG 3)
- Let the line feed through till the desired position is found.
- Move the webbing handle back to a parallel position to the DPML to set the line in the cleats teeth. (FIG 2)

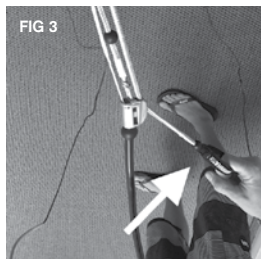
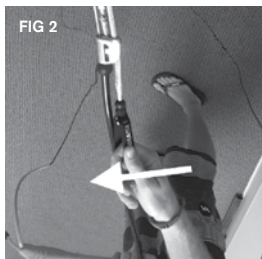
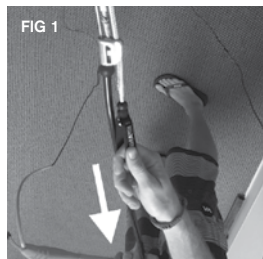

OPERATION

SECURITY LINE: OPERATION

SLF is a simplified bridle and control system that seamlessly provides 2 stages of depower. Interactive Depower on Demand (Stage 1) while riding, and a Stage 2 Depower (Stage 2) method to shut down your kite. Stage 2 Depower Functions by transferring the kites power onto 1 single line upon deployment, allowing the kite to 'Flag Out'. Our SLF equipped kites use only 4 lines for a simple, uncluttered method of control and Security.

Depower on Demand: Stage 1 depower

Operation: Depower on demand is the simplest way to quickly depower your kite in an instant. By pushing the control bar away from the rider, the kite will immediately begin to depower. The further you push the bar away from the rider the more the kite will depower. By pushing the bar up near the CAS (FIG 1), it will depower to the point where it will fall from the sky. This is your best defense to immediately diffuse the power of the kite so you can quickly regain control. Once the kite has safely landed on the water, it will be in a position where you can easily perform an Instant Relaunch.

Stage 2 Depower:

Stage 2 Depower should only be used in situations where you would like to shut down your kite and end your session, whether it be on water or land. It should be noted that relaunching your kite using this method is slightly more difficult than the Depower on Demand method. Stage 2 Depower is designed to release the residual power from your kite by allowing it to 'Flag' out on one of the Front Control lines.

Operation: In order to use Stage 2 Depower, you must have your Bypass Leash attached to the Leash Connection ring attached to the 1X Flagging Line. It is also important that you familiarize yourself with the location and operation of all QR's prior to going on the water.

Stage 2 Depower can only be achieved by activating (pushing away) QR1 in the direction of the arrow (FIG 2). By activating QR1, the harness loop will open up, releasing you from your spreader bar and transfer the load onto the Single Line Flag security line. The kite can

now achieve maximum depower, and will flag itself on the water or land.

Once the kite has safely landed, you can pull yourself towards the kite by "walking" up the SLF security line and control Line. When you come to the bar, it's important that you continue up towards the kite without grabbing the control system or the depower mainline. Do so will result in having the SLF Security Line and control line paying back out and possibly powering the kite back up. Only handle the landing line itself until you get to the leading edge of the kite. If at any point throughout this process, the kite begins to pull and you resist, the kite may pull back harder. The best thing to do here is to take a step or two towards the kite in an effort to get it to flag out completely. Continue up the SLF line until you reach the leading edge. From there you can secure the kite with sand (if you are on land) or perform a self rescue (if you are on water).

Disconnecting from the kite

If at anytime during the Stage 2 Depower process (after QR1 has been activated), you absolutely need to completely separate yourself from the kite, you must also activate the quick release located on your bypass leash. (FIG 3/4)

Important: Disconnecting from your kite may cause your kite to blow downwind unaccompanied. Avoid at all costs, doing this in a situation where your loose kite may endanger others. Disconnecting from your kite at sea may also mean the possibility of not being able to retrieve your kite. Use extreme caution and judgement when disconnecting from your kite.

Resetting the SLF landing line

Once you have recovered your equipment safely on the beach, you will need to reset the Security line to use it again. Stretch your lines out as if you were going to attach them to your kite. Separate the lines from each other so that each individual line is lying parallel to the next one. Make sure that the security line is not wound around any other line. Reset the QR1 as stated on Page 15 of this manual.

FIG 1

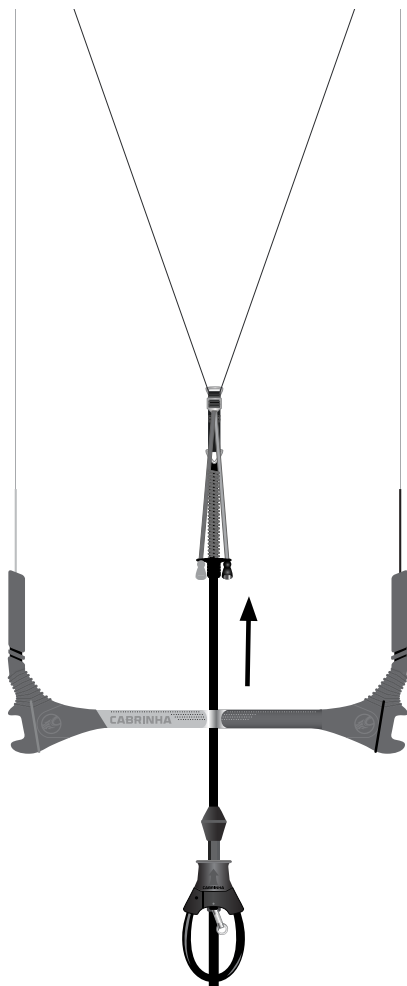

FIG 2



FIG 3

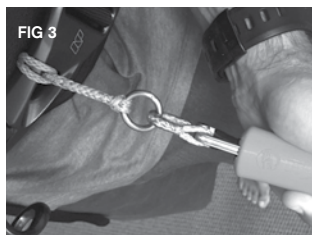

FIG 4



OVERDRIVE BAR ADJUSTMENT

OVERDRIVE BAR ADJUSTMENT.

The Overdrive Bar has a method of changing the bar length, to suit different riding styles, or different sized kites.

OVERDRIVE OPERATION.

Adjustment from inside to Outside Setting.

- Lightly Push the upper end of the bar end in slightly. This in turn releases the load on the catch mechanism.
- With the Upper section pushed in, pull down the Overdrive Catch, and release the upper end of the bar end. (FIG 1)
- Pull the upper end of the bar end outwards until you hear the Catch connect. As a visual guide you will also see the catch has now moved upwards into the bar end. (FIG 2)
- Repeat this process for the other end of the bar before flight.

Adjustment from Outside to Inside Setting.

- Lightly Push the upper end of the bar end outwards. This in turn releases the load on the catch mechanism.
- With the Upper Section Pushed outwards, pull down on the Overdrive Catch, and release the upper end of the bar. (FIG 3)
- Push the Upper Section of the Bar end inwards until you hear the Catch connect. As a visual guide you will also see the catch has now moved upwards into the bar end. (FIG 4)
- Repeat this process for the other end of the bar before flight.

CAUTION: Be advised to check that the bar ends are functioning correctly before use, and both ends are locked in the required position. (out/out or in/in).

Overdrive Care and Maintenance.

- Wash the Overdrive 1X System frequently in fresh water. Do this by placing the complete bar in a bucket of fresh water and allow it to sit for 5 minutes. While in the fresh water rotate the Overdrive Harness Loop, and also operate the Overdrive Bar ends. Allow the Overdrive 1X System to dry thoroughly before storing.
- Make sure that all sand is rinsed off from the Overdrive System before riding.
- Ensure that the Security Pin is firmly attached to the Overdrive Bridge (as mentioned on Page 17 FIG 8).
- Use the correct leash attachment point on the Overdrive System (as mentioned on page 18 FIG 2).
- Routinely operate the QR2 release.
- To aid in the longevity of the Overdrive Bar Ends, routinely flush water through the bar end from the upper section down.

FIG 1



FIG 2



FIG 3



FIG 4



⚠ WARNING

STEERING

This is a partial list of techniques to be remembered and applied. Be certain to always take instruction from a professional.

KEY POINTS TO REMEMBER

- When practicing steering a kite on land, always remember that your kite has extreme power. Be prepared. We suggest you develop your kite handling skills on land with a trainer kite, and then move to the water for further practice using the “body dragging” techniques with your power kite.
- When first learning to fly your kite, always keep your eyes on the kite.
- Steer slowly. Do not make any abrupt motions with the control bar.
- Keep in mind the power of the kite.
- Never turn the control bar like a car steering wheel. It is ineffective for steering the kite and may actually cause the kite to become out of control.

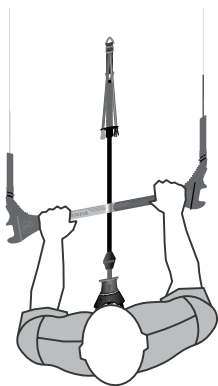

Steering the Kite to the Left

- Hold the bar with both hands, shoulder distance apart.
- With your eyes on the kite, slightly pull on the control bar with your left hand, pulling it toward your body.
- This will allow your left arm to bend and your right arm to extend. Keeping one arm extended is important; do not pull both arms toward your body at the same time.
- Pull slowly. The quicker your movements, the faster the kite will turn and the more power it will create.
- Once the kite starts to turn, it will continue to turn left unless you “tell it” otherwise.
- Be ready to steer the kite in the other direction.

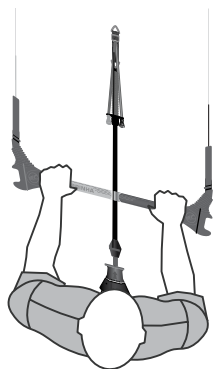

Steering the Kite to the Right

- Hold the bar with both hands, shoulder distance apart.
- With your eyes on the kite, slightly pull on the control bar with your right hand, pulling it toward your body.
- This will allow your right arm to bend and your left arm to extend. Keeping one arm extended is important; do not pull both arms toward your body at the same time.
- Pull slowly. The quicker your movements, the faster the kite will turn and the more power it will create.
- Once the kite starts to turn, it will continue to turn right unless you tell it otherwise.
- Be ready to steer the kite in the other direction.

IMPORTANT!

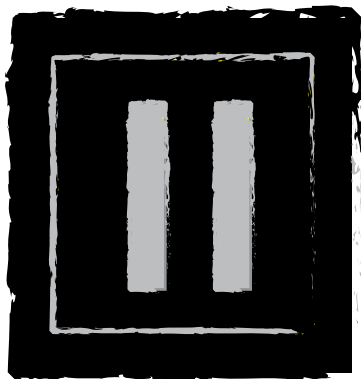

PAUSE!

FOR SETUP OF YOUR CABRINHA KITE, REFER TO YOUR SUPPLIED KITE USER MANUAL.

IF YOU ARE UNSURE AS TO WHICH KITES ARE COMPATIBLE WITH THIS CONTROL SYSTEM, PLEASE REFER TO THE KITE/CONTROL SYSTEM COMPATIBILITY CHART AVAILABLE ONLINE AT WWW.CABRINHAKITES.COM.

LAUNCHING WITH A PARTNER

1. Before launching, re-familiarize yourself with your Quick Release System in the event that you must engage them. Make sure you have them properly set up.
2. Next, thoroughly check your lines, your gear, and your launching and landing sites; if all is okay, you are ready to launch your kite. Be certain your kite is properly inflated; this is imperative to the re-launchability of your kite.
3. Before you launch, organize a clearly defined release signal that you and your partner both understand.
4. Connect your Bypass™ leash to the leash attachment point
5. Next, engage the security pin.
6. Have your partner stand with the kite at 100° off of the wind. (FIG 1)
7. Your partner should hold the kite in the middle of the leading edge, with the leading edge vertical and pointing into the wind.
8. Your partner should stand behind the kite and not to the side or in front of the kite.
9. Also, your partner SHOULD NOT touch the bridle or flying lines.
10. With the control bar in your hands and at chest height, take a few steps back to take the slack out of the flying lines.
11. Signal your partner to let go of your kite. It is important that your partner lets you steer the kite out of his or her hands.
12. **CAUTION:** Your partner SHOULD NOT throw the kite into the air. Instruct him/her against doing this BEFORE you launch. When the kite is thrown into the air, it hinders the ability of the kite to launch properly. When thrown, the kite may either launch too abruptly and powerfully or it may not launch at all. It is potentially a very dangerous way to launch.
13. Once your partner lets go of the kite, have him/her move upwind of you and out of your way.
14. SLOWLY steer the kite to the edge of the power window. DO NOT make any abrupt motions. The slower you steer the kite, the more in control you will be.
15. With the kite at the edge of the power window and the wind at your back, walk slowly to the water's edge, keeping in constant check with the kite. You should know what the kite is doing at all times.
16. If anything goes wrong with the launch, you should be ready to push the control bar away to depower the kite.
17. **CAUTION:** the more wind there is during your launch, the faster everything will happen. That is why it is important that you launch the kite slowly.

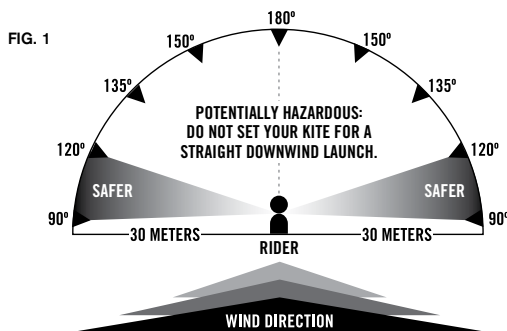

LANDING

LANDING A KITE TO YOUR PARTNER

1. Prior to launching, make sure your partner has been instructed on how to land your kite properly.
2. Also, you should always determine adequate landing spots before you launch your kite.
3. Having done that, make sure that when you are heading toward shore, that your landing location is still un-crowded and un-obstructed.
4. Never land your kite over, on top of, or near others, especially if they are downwind of you. You should have an area clear of people, pets, power lines, trees, and other obstructions.
5. As you approach shore, keep your kite low near the water, at the edge of the power window.
6. Drop down (or step) off your board and body drag the final distance to shore. Do not approach the shoreline with speed.
7. Slowly steer your kite into the wind and to your partner.
8. Your partner should be on the windward side of your kite as he/she approaches it.
9. Once the kite is nearly touching the ground, your partner should grab the kite at the middle of the leading edge strut. He/she should grab the kite in the same location on the kite as when it was launched.
10. Your partner **SHOULD NOT** grab the kite bridles or flying lines.
11. Your partner should **AVOID** grabbing the kite by either wing tip or the trailing edge of the kite. Grabbing the kite by the wing tip or the trailing edge will often cause it to flip or spin; the kite will also be hard to manage.
12. Once your partner has the kite's leading edge, he/she should walk the kite away from the water's edge.
13. Your partner may either continue to hold the kite or he/she may secure the kite by turning it over, with the struts down and the leading edge pointed into the wind, and securing it with sand or sand bags.
14. Once on land, with your kite secured, you may wind up your lines.

IMPORTANT CAUTION: Proper inflation of the struts, especially the leading edge, is imperative for re-launchability of your kite. Make sure your kite struts are properly inflated before entering the water.

- When your kite goes down on the water, know that the kite may re-launch on its own, often when you do not expect it to, so be prepared.
- If your kite goes down on its face, with the leading edge and struts facing the water, you must steer the kite onto its side in order to re-launch.
- Pull the rear leader line toward your body. Maintain constant tension on this leader line.

CAUTION: Make sure not to wrap the leader line around your hand and do not allow your body to get entangled in the lines. You may need to pull as much as one full meter of leader line in order to lift the wingtip of the kite.

- HINT: Keep your board on your feet and in front of you. This will slow your forward momentum and increase the speed of relaunch.
- Once the wingtip begins to lift, the kite will soon roll onto its side.
- Once on its side, the kite will begin to move toward the edge of the wind window. You may have to finesse the kite to the edge of the window; to do this continue to hold onto the same leader line until the kite wants to re-launch.
- Sometimes, especially in light wind, you must be patient as the kite works its way to the edge of the wind window. Do not get impatient and start pulling on both sides of the bar. Continue to work the kite to the original side you chose.
- When the kite is ready to re-launch, release the leader line and steer the kite up into the sky. Slowly steer your kite into the sky and level out your bar. Be prepared to depower the kite by pushing the control system toward the kite.



TUNING

TUNING THE KITE

Proper tuning of your kite is essential for best performance. A properly tuned kite increases its efficiency, speed, and allows the kite to de-power correctly. The following guidelines will help you to properly tune the kite to suit your style of riding.

- All models have a desired sweet spot that is achieved by the correct tension of the steering (back) and de-power (front) lines. Fine-tuning of the kite may be done by making small adjustments to the Centerline Adjustment Strap (CAS.).
- Please note that, due to the full range of depower available in the system, the CAS is used to position the bar within the depower range. If you find yourself riding with your arms fully extended and bent over at the waist, you can pull the red ball and the bar will move closer to you.
- The kite is very sensitive to over sheeting. Too much back line tension can cause the kite to fly slowly or even backwards in light wind. Over sheeting will also minimize the amount of shutdown available in the depower range.
- Do not 'over sheet' the kite. The first objective is to set the kite's maximum power while allowing it to fly efficiently across the sky. More power and quicker turning is achieved by tensioning the steering (back) lines. This is called 'sheeting in the kite'. There is however, a point of diminishing returns. Too much back line tension will cause the kite to fly slowly across the sky and not allow it to fly to the edge of the power window.
- With the kite directly overhead, hook into the harness loop and fully sheet in (power up) the kite. If the kite is over-sheeted, the kite will sit back in the window.

CAUTION: Beware of lofting. Leaving the kite overhead for long periods of time increases the risk of this phenomenon. If you feel yourself being lifted, sheet out immediately and be ready to pull your QRS.

- De-power the kite by pulling on the CAS until the desired effect is achieved. The more you pull on the CAS the less power the kite will have. Keep in mind that you will still be able to de-power the kite through the Depower Loop, so do not de-power too much with the CAS. To increase power, pull down on the black power adjustment ball.

VIEW OF KITE FROM RIDERS PERSPECTIVE – KITE IN THE NEUTRAL POSITION DIRECTLY ABOVE THE RIDER.

Over sheeted wingtip >>
(too much back line tension)

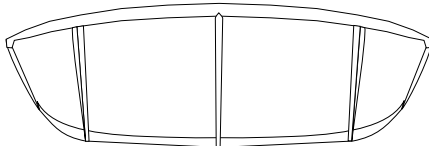

Correct Trim >>

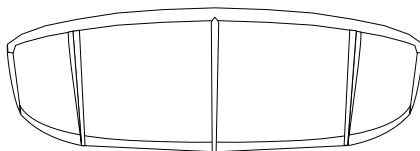

FREQUENTLY USED KITEBOARDING & WIND TERMINOLOGY

A

AIR DISTRIBUTION TUBES

Tubes that connect the LE bladder to the strut bladders. AIR-LOCK - a 2 part valve that allows a single point for inflation and deflation of the kite.

AIR CLIPS

Clips that prevent air transfer between the LE and the struts.

B

BAR (unit) – A unit of pressure

- 1 bar = 14 PSI
- 1 mbar = 0.015 PSI

PSI – A unit of pressure. Pounds per square inch

- 1 PSI = 68.9mbar

BEAUFORT SCALE

A system for estimating wind strength based on the effects wind has on the physical environment (e.g. the behavior of waves, smoke, etc.). Instruments are not used to determine wind strengths in this point scale (0 = calm to 12 = hurricane).

BODY DRAGGING

This is an instructional tactic / step in which the rider flies the kite while in the water, but without the board. The rider will launch, then walk to the water, and basically drag in the water while practicing flying, re-launching and self-rescue techniques.

BLADDER

The inner inflatable tube found within the leading edge and the struts of the kite. (Imagine a bike-it has both a tire on the outside and an inner tube which holds air).

BRIDLES

The lines that hang from the wing tips and leading edge of the kite. The flying lines will be attached from the control bar to these bridle lines in order to connect control bar to kite.

Tow Points – The attachment points for the bridle.

BYPASS™ LEASH SYSTEM

A security leash feature that is recommended for all users. This system incorporates QR2 which will separate the User from the Kite if QR1 has been activated.

C

CENTERLINE ADJUSTMENT STRAP (CAS)

Used to depower the kite by changing the relationship between the front and back line lengths. It is also used to position the bar closer to the rider.

CONTROL BAR

The steering device the rider uses to steer the kite.

D

DE-POWER LINES

The two center flying lines that attach to the leading edge bridle on the kite—one to the left wing tip, the other to the right wing tip. These lines assist in de-powering the kite.

DOWNWIND

The direction in which the wind is traveling.

F

FLYING LINES

A term used to describe all four of the lines included with your kite package. These lines connect the bridle lines on the kite to the leader lines on the control bar and are typically 20-30 meters in length.

G

GUSTY WIND

Wind is inconsistent and varies considerably from one wind strength to another.

GYBING

The motion in which the rider changes the direction of the board he/she is riding. The rider switches from a starboard tack to a port tack or vice versa.

H

HARNESS

A piece of equipment used to temporarily attach the rider to the control bar harness line. This enables the rider to save energy by utilizing their body weight and all of their muscles to hang on to the kite. Most common are the waist harness (attaches around the torso) and the seat harness (attaches to the waist and around the legs).

I

INFLATABLE KITE

A kite with inflatable tubes designed to float the kite and to facilitate water re-launchability.

K

KITEBOARDING

The term used to describe the sport of power kiting on water or snow.

KITESURFING

Another term used to describe the sport of power kiting on water.

GLOSSARY

KNOTS

A measure of speed based on nautical miles.

1 knot = 1 nautical mile per hour.

1 knot = 1.15 miles per hour.

1 knot = 1.85 kilometers per hour.

L

LANDING

The action which places the kite on the water or on land.

LAUNCHING

The motion in which the rider steers the kite from their partner's hands into the sky.

LEADER LINES

The lines that attach directly to the control bar. You will attach these lines to the flying lines in order to connect them to your bar.

LEADING EDGE (LE)

The front inflated tube of your kite.

LEEWARD

The downwind side of the kiteboarder.

LOFTING

Lofting occurs when the kite is above the riders head in the neutral position. Instability in the wind can cause sudden vertical force and lift a rider off of their feet.

LUFF

A term used to describe what happens to the kite in a lull. A term also used to describe the complete de-powering of a kite.

LULL

A term used to describe wind when it lessens in strength, for any amount of time.

M

MPH

Miles Per Hour. A measure of speed.

1 mph = 1.6 kilometers per hour.

N

NEUTRAL POSITION

This is the position just above the rider's head in the sky. If the rider levels out the bar, the kite will gravitate to the neutral position. However, it is difficult and dangerous to keep the kite in this position. Although in this position the kite may feel steady and may feel like it has the least amount of power or pull, it is also the position in which on land the rider is most susceptible to lofting. On the water, the neutral position can be utilized to rest while you reel in your board, but on land, we strongly suggest you do not utilize the neutral position. After launching, it is best to make your way to the water without delay. Do NOT linger on land with the kite in neutral position. It is VERY dangerous.

NEUTRAL ZONE

This is the area that includes the neutral position and the area to the left and right of the rider. It encompasses the most upwind or windward positions in which to fly the kite. When flown here, the kite has less power or pull than when it is in the power zone. However, use caution when the kite is in this zone, especially when on land, and especially in gusty wind conditions.

O

OFFSHORE

Wind is blowing from the shore directly or to a great extent out to the water. Do not operate your kite in or near water in this wind direction.

ONSHORE

Wind is blowing directly or to a great extent directly from the water toward the land. Do not operate your kite in or near water in this wind direction.

OVER-POWERED

A situation in which the rider has a kite too powerful for his/her ability level, weight, strength, and/or wind conditions.

P

PLANING

The point in time in which the rider gets the board skimming on the water.

POWER ZONE

This is the area in front and to the sides of the rider, but excluding the neutral position and zones. It is the area in which the kite has the most power and pull. When flown in this area, the kite can be powerful and dangerous, so avoid flying your kite in this zone when learning. Use extreme caution when flying the kite in this zone.

PUMP – Device used to inflate the kite.

Q

QRS-QUICK RELEASE SECURITY SYSTEM

A quick release point on the control system which, when activated, detaches the control system from the harness loop. Also referred to as the Main QR.

QR2

A secondary quick release located on the Bypass Leash. When activated separates the security line from the user. Thus separating the kite from the user.

QUICKLOOP

Quickloop refers to the molded harness loop body. This system gives the user a quick and effective way to re-connect the harness loop after QR1 Deployment.

R

REACH

A direction of travel relative to the wind direction. Generally 90-160 degrees off the wind.

RECOIL

Recoil is a convenience item, which allows riders a spot to rest the bar while unspinning it from rotational tricks. It also serves as a unit to keep tension on the bungee adjusters while keeping them at arms reach.

RE-LAUNCHING

The motion in which the rider steers the kite off of the water and back into the sky.

S

SIDE OFFSHORE

Wind is blowing from either the left or the right and from the shore out to the water. This is a combination of offshore and sideshore wind. Do not operate your kite in or near water in this wind direction.

SIDESHORE

Wind is blowing from the left or from the right, parallel to the shore. Ideal wind direction for kiteboarding.

SIDE ONSHORE

Wind is blowing from either the left or the right and from the water toward the land. This is a combination of onshore and sideshore wind. Utilize caution when operating your kite in or near water in this wind direction.

SINGLE LINE FLAG

SLF is a simplified bridle and control system that seamlessly provides 2 stages of depower.

SPRINT™

Single Point Rapid Inflation Technology.

STAGE 2 DEPOWER

Stage 2 Depower is a built in function of 1X which allows the rider to self land a kite on the water or land.

STEERING LINES

The two outside flying lines that attach to the trailing edge bridles on the kite—one to the left wing tip and the other to the right wing tip.

STRUTS

The outer fabric tubes found on your kite. They house the inner inflatable bladders, which are filled with air to give structure to the kite.

T

TRAINER KITE

A kite that may be used on land to simulate the motions used in kiteboarding. It is an excellent instructional and learning tool. Despite its small size, this kite still has power, so be alert.

U

UNDER-POWERED

A situation in which the rider has a kite not powerful enough for his/her weight, strength, and/or wind conditions.

UPWIND

The direction from which the wind is blowing.

W

WATER STARTING

The motion of the rider in which he/she goes from sitting or lying in the water to standing on the board.

WINDWARD

The upwind side of the kiteboarder.

