

GX-L SERIES

GF-L SERIES

High-Capacity Precision Balances

INSTRUCTION MANUAL

GX-L Series

GX-12001L / GX-22001L / GX-32001L / GX-32001LD / GX-42001L / GX-62001L
GX-62000L / GX-102000L
GX-32001LS / GX-32001LDS / GX-62001LS / GX-62000LS / GX-102000LS



GF-L Series

GF-12001L / GF-22001L / GF-32001L / GF-62000L



This Manual and Marks

All safety messages are identified by the following, “WARNING” or “CAUTION”. The meanings are as follows:

 WARNING	A potentially hazardous situation which, if not avoided, could result in death or serious injury.
 CAUTION	A potentially hazardous situation which, if not avoided, may result in minor or moderate injury.

 This is a hazard alert mark.

Note for precautions:

- Caution** Describes the points to be careful for appropriate use.
- Note** Describes ‘highly possible to be handled inappropriately’ or ‘general advice in using the product’.

About This Manual

- (1) No part of this manual may be reprinted, copied, modified, or translated to another language without the prior written consent of A&D Company, Limited (A&D).
- (2) The contents of this manual are subject to change without notice.
- (3) Please contact A&D if you notice any uncertainty, errors, omissions, etc. in this manual.
- (4) A&D bears no liability for any loss or lost profits due to the operation of this product, and for direct, indirect, special, or consequential damages resulting from any defect in this product or this manual, even if advised of the possibility of such damage. Furthermore, A&D assumes no liability for claims of rights from third parties. Concurrently, A&D assumes no liability whatsoever for software or data losses.

© 2023 A&D Company, Limited

- Microsoft®, Windows®, Word®, and Excel® are trademarks of the Microsoft group of companies.
- The Bluetooth® word mark and logos are registered trademarks owned by Bluetooth SIG, Inc. and any use of such marks by A&D is under license.
- Product names and company names mentioned in this manual are trademarks or registered trademarks of their respective companies in Japan or other countries and regions.

Contents

1. Introduction.....	7
1-1. Features	7
1-2. About the models	8
1-3. Compliance	8
2. Part Names, Installation and Precautions.....	8
2-1. Assembly and installation.....	11
2-2. Precautions before use (Installation considerations and preparation).....	13
2-3. Precautions during use (for more accurate weighing)	15
2-4. Cautions after use	16
2-5. Caution on the power supply.....	17
3. Display and Key Panel (Basic Operation).....	18
3-1. Smart range function	20
4. Weighing	22
4-1. The units of measurement	22
4-2. Basic operation.....	31
4-3. Counting mode (PCS)	33
4-4. Percent mode (Percent weighing mode).....	35
4-5. Animal weighing mode (Hold function).....	36
5. Impact Shock Detection (ISD) Function.....	37
5-1. Recording impact history.....	37
5-2. Impact history output.....	38
6. Response Adjustment / Self-check Function	39
6-1. Response adjustment.....	40
6-2. Self check function / automatic setting of minimum weight with ECL.....	41
7. Sensitivity Adjustment / Calibration Test.....	43
7-1. Automatic sensitivity adjustment (GX-L series only).....	45
7-1-1. Inputting the set time.....	46
7-1-2. Clearing the set time	47
7-1-3. Setting the interval time	48
7-2. Sensitivity adjustment using the internal weight (GX-L series only).....	50
7-3. Sensitivity adjustment using an external weight	51
7-4. Calibration test using an external weight	52
7-5. Setting the value of the weight.....	53
7-6. Correcting the internal weight value (GX-L series only).....	54
7-6-1. Correcting the internal weight value AUTO (GX-L series only).....	55
7-6-2. Correcting the internal weight value MANUAL (GX-L series only)	56
8. Function Selection Switch and Initialization.....	58
8-1. Function selection switch	58
8-2. Initializing the balance	60
8-2-1. Initialization (all items).....	60

8-2-2.	Initialization (function table only).....	61
9.	Function Table	62
9-1.	Setting the function table.....	62
9-2.	Details of the function table.....	64
9-2-1.	Output of the function table information.....	73
9-3.	Description of the class “Environment/Display”	75
9-4.	Clock and calendar function.....	78
9-5.	Comparator function.....	80
9-6.	Description of the item “Data output mode”	91
9-7.	Weighing data format	94
9-7-1.	Output examples of weighing data format	99
9-8.	Description of application mode	100
9-9.	Storing units	101
10.	ID Number and GLP Report	103
10-1.	Main objective	103
10-2.	Setting the ID number	104
10-3.	GLP report.....	104
11.	Data Memory.....	108
11-1.	Data memory for weighing data	108
11-2.	Data memory for sensitivity adjustment and calibration test.....	112
11-3.	Data memory for “unit weight” in the counting mode	115
11-4.	Data memory for comparator settings.....	118
11-5.	Data memory for tare value.....	121
11-6.	Data memory: Quick selection mode	124
11-7.	Data memory: Selection/confirmation/storage mode	125
12.	Statistical Calculation Mode	127
12-1.	How to use the statistical calculation: Preparation.....	128
12-2.	Statistical calculation mode (Example of use)	133
13.	Flow Rate Measurement	135
13-1.	Overview	135
13-1-1.	About flow rate display (FRD) function	135
13-1-2.	Flow rate calculation method	137
13-1-3.	Examples of manual setting of flow rate calculation time (Ct).....	138
13-2.	How to use flow rate display (FRD) function.....	140
13-2-1.	Switching to flow rate measurement mode (function table).....	140
13-2-2.	Changing flow rate units	140
13-2-3.	Setting the flow rate calculation time (Ct)	141
13-2-4.	Density input and settings.....	146
13-2-5.	Switching displays.....	147
13-3.	Example of use.....	148
13-3-1.	Example of flow rate measurement with pump.....	148
13-4.	Using the comparator	149
13-4-1.	Changing comparison target value	149
13-4-2.	Example of using the comparator	150

13-5. Using analog voltage output.....	152
13-5-1. Example of using analog voltage output.....	153
13-6. Commands	154
14. Minimum Weight Alert Function	156
14-1. Minimum weight comparison.....	157
14-2. Input and output of minimum weight	158
14-2-1. Setting procedure using the function table	158
14-2-2. Procedure to set in weighing mode.....	161
14-2-3. Procedure to output the settings in batch	161
14-3. Outputting data less than the minimum weight	163
15. Density (Specific Gravity) Measurement	164
15-1. Preparing for measurement (Changing the function table).....	164
15-2. Measuring the density (specific gravity) of a solid (Function table <i>dS 0</i>)	165
15-3. Inputting the density of a liquid.....	166
15-4. Measuring the density (specific gravity) of a liquid (Function table <i>dS 1</i>)	167
15-5. Inputting the volume of the float	168
16. Password Lock Function	169
16-1. Enabling password lock function.....	171
16-2. Entering a password at the start of weighing	172
16-3. Logging out.....	173
16-4. Registering (changing) password.....	174
16-5. Changing password.....	175
16-6. Deleting password (<i>USER 01</i> to <i>10</i>).....	176
16-7. If password is lost or forgotten	176
17. Repeatability Check Function (GX-L series only)	177
18. Interface Specifications	178
18-1. RS-232C.....	178
18-2. USB	180
19. Maintenance	181
19-1. Treatment of the balance	181
20. Troubleshooting.....	182
20-1. Checking the balance performance and environment	182
20-2. Error displays (error codes).....	183
20-3. Other display	187
20-4. Asking for repair	187
21. Connecting Peripheral Devices	188
21-1. Cables needed to connect to peripheral devices	188
21-2. About data output method.....	189
21-3. Specific examples when connecting multiple peripheral devices at the same time	190
21-4. Printing weighing values to the printer	193
21-4-1. AD-8127 multi-functional compact printer.....	193
21-5. Connecting to a PC	195

21-5-1.	Quick USB mode.....	195
21-5-2.	Virtual COM mode.....	196
21-5-3.	RS-232C	196
21-5-4.	WinCT data transmission software (USB Virtual COM mode or RS-232C)	197
21-6.	Windows communication tools for parameter setting (“WinCT-ParamSet”)	198
21-7.	Commands	199
21-7-1.	Control commands.....	199
21-7-2.	The <AK> code and error codes.....	202
21-7-3.	Command usage examples	203
21-8.	The UFC function	208
21-8-1.	UFC program commands.....	208
21-8-2.	Examples of creating UFC program commands.....	210
21-9.	Key lock function	211
21-9-1.	Locking all key switches.....	211
21-9-2.	Locking specified key switches	212
22.	Checking the software version of the balance	213
23.	Specifications	214
23-1.	Common specifications	214
23-2.	Individual specifications	215
24.	External Dimensions.....	218
25.	Options and Accessories	220
25-1.	Options	220
25-2.	Accessories (sold separately)	222

1. Introduction

Thank you for purchasing A&D's GX-L/GF-L series high-capacity electronic balance.

Please read this instruction manual carefully to understand and make full use of the balance before using it.

1-1. Features

- The balance has a self-check function that inspects the balance itself using electronically controlled load (ECL) and evaluates repeatability performance.
- The balance can detect the impact applied to its mass sensor, and display and store the impact level.
Impact Shock Detection (ISD)
- Continuous weight change can be calculated, displayed, and output as flow rate.
Flow Rate Display (FRD)
- Equipped with a data memory function to store weighing values, sensitivity adjustment records, and multiple unit weights (mass per sample in counting mode). (For weighing values, up to 200 values can be stored.)
- The GX-L series has automatic self sensitivity adjustment function using the internal weight, adapting to temperature changes, setting time and interval time.
- When performing the sensitivity adjustment/calibration test, etc. for the balance, the output corresponding to GLP/GMP, etc. can be output.
Using a printer (sold separately), it is possible to record the sensitivity adjustment/calibration test results.
GLP: Good Laboratory Practice. Standards for implementing safety tests for drugs and medicines.
GMP: Good Manufacturing Practice. Rules for manufacturing and quality control.
- The clock function built into the balance allows you to output the weighing value with the date and time.
(The clock settings can be restricted so that only the Administrator can change them. [Password function])
- Comparing the weighing value and the preset upper/lower limit value, the comparator Indicators can display the comparison results with the / / indicator. (5-step comparison setting is also available.)
- Capacity Indicator displaying the weight value in percentage relative to the weighing capacity.
- Hold Function is provided for weighing a moving object such as an animal.
- For measuring density or weighing magnetic materials, the optional GP-20/21 underhook can be used.
- With the password function, the use of the balance and the operation of changing the function table can be restricted.
- With the key lock function, the key operation can be disabled and the balance can be operated only by a command from an external device.
- RS-232C and USB interfaces for outputting the weighing value and data of the balance are equipped as standard. Windows Communication Tools Software (WinCT) makes it easy to communicate with a Windows personal computer. The latest version of WinCT is available for download on A&D website.
Windows is the trademark of the Microsoft Corporation., registered in the U.S. and other countries and regions.

1-2. About the models

The GX-L/GF-L series are available in multiple models with different combinations of weighing capacities and readability.

In this manual, they are classified and described according to the readability as shown in the table below.

Model	Readability	Series	
		Internal adjustment type	External adjustment type
0.1 g model	0.1 g / 0.5 g	GX-12001L / GX-22001L / GX-32001L GX-32001LD / GX-42001L / GX-62001L GX-32001LS / GX-32001LDS / GX-62001LS	GF-12001L / GF-22001L / GF-32001L
1 g model	1 g	GX-62000L / GX-102000L GX-62000LS / GX-102000LS	GF-62000L

- The GX-L series is equipped with the internal weight for sensitivity adjustment. You can use functions such as sensitivity adjustment using the internal weight and automatic sensitivity adjustment.
- The GF-L series does not have a built-in weight for sensitivity adjustment. When performing sensitivity adjustment, it is necessary to prepare a calibration weight separately.

1-3. Compliance

Compliance with FCC Rules

Please note that this equipment generates, uses and can radiate radio frequency energy. This equipment has been tested and has been found to comply with the limits of Class A digital devices pursuant to Part 15 of FCC rules. These rules are designed to provide reasonable protection against interference when equipment is operated in a commercial environment. If this unit is operated in a residential area, it may cause some interference and under these circumstances the user would be required to take, at his own expense, whatever measures are necessary to eliminate the interference. (FCC = Federal Communications Commission in the U.S.A.)

2. Part Names, Installation and Precautions

This product is a precision instrument, and it should be carefully unpacked.

The contents of the package vary depending on the product. Refer to the illustration of the packing contents on the following pages to make sure that everything is included.

It is advisable to store the packing materials so that they can be used when transporting the balance for repair.

(1) Swing-arm type

GX-12001L / 22001L / 32001L / 32001LD / 42001L / 62001L / 62000L / 102000L
 GF-12001L / 22001L / 32001L / 62000L

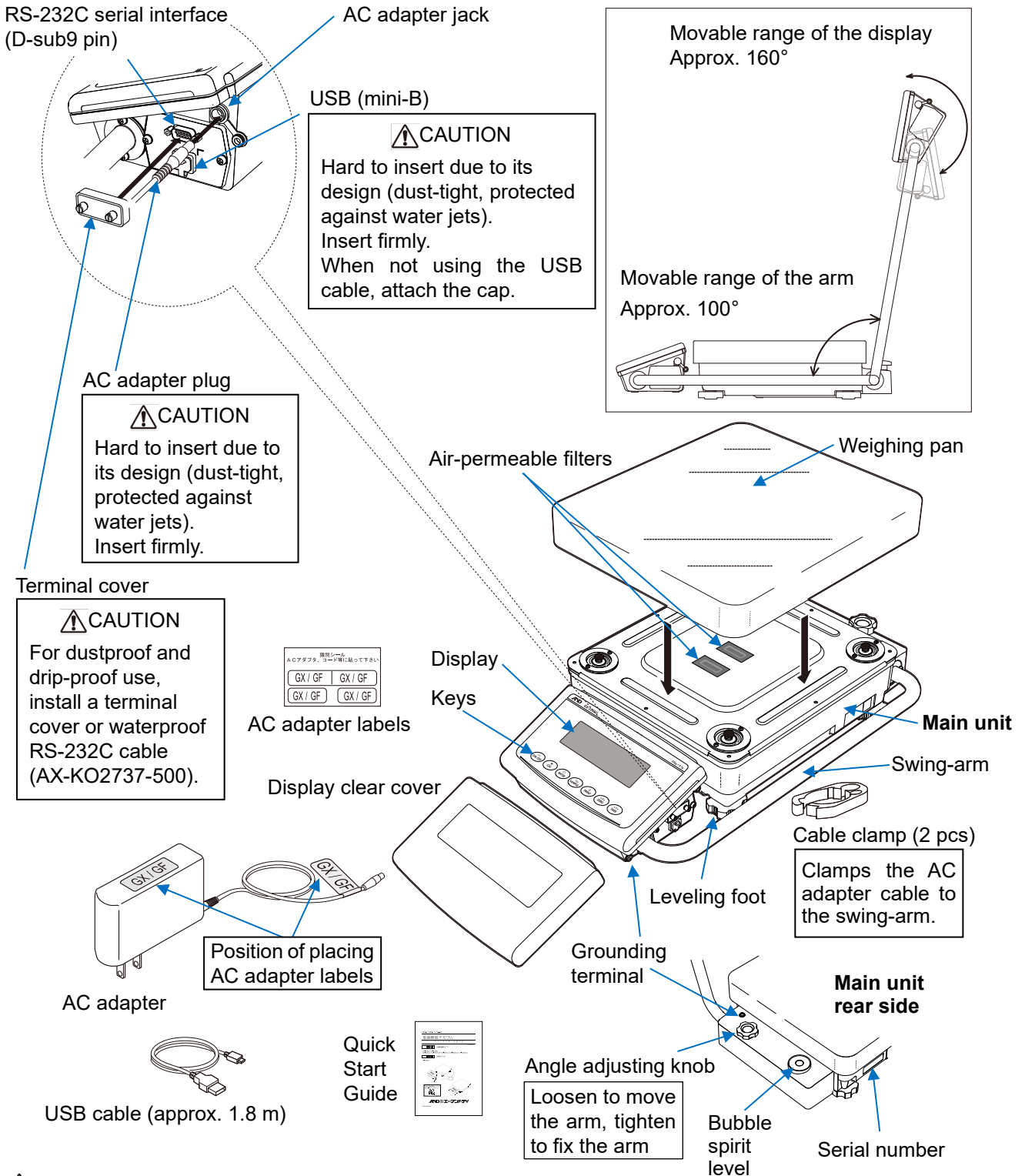

CAUTION

- Please confirm that the AC adapter type is correct for your local voltage and receptacle type.

(2) Separate type
 GX-32001LS / 32001LDS / 62001LS / 62000LS / 102000LS

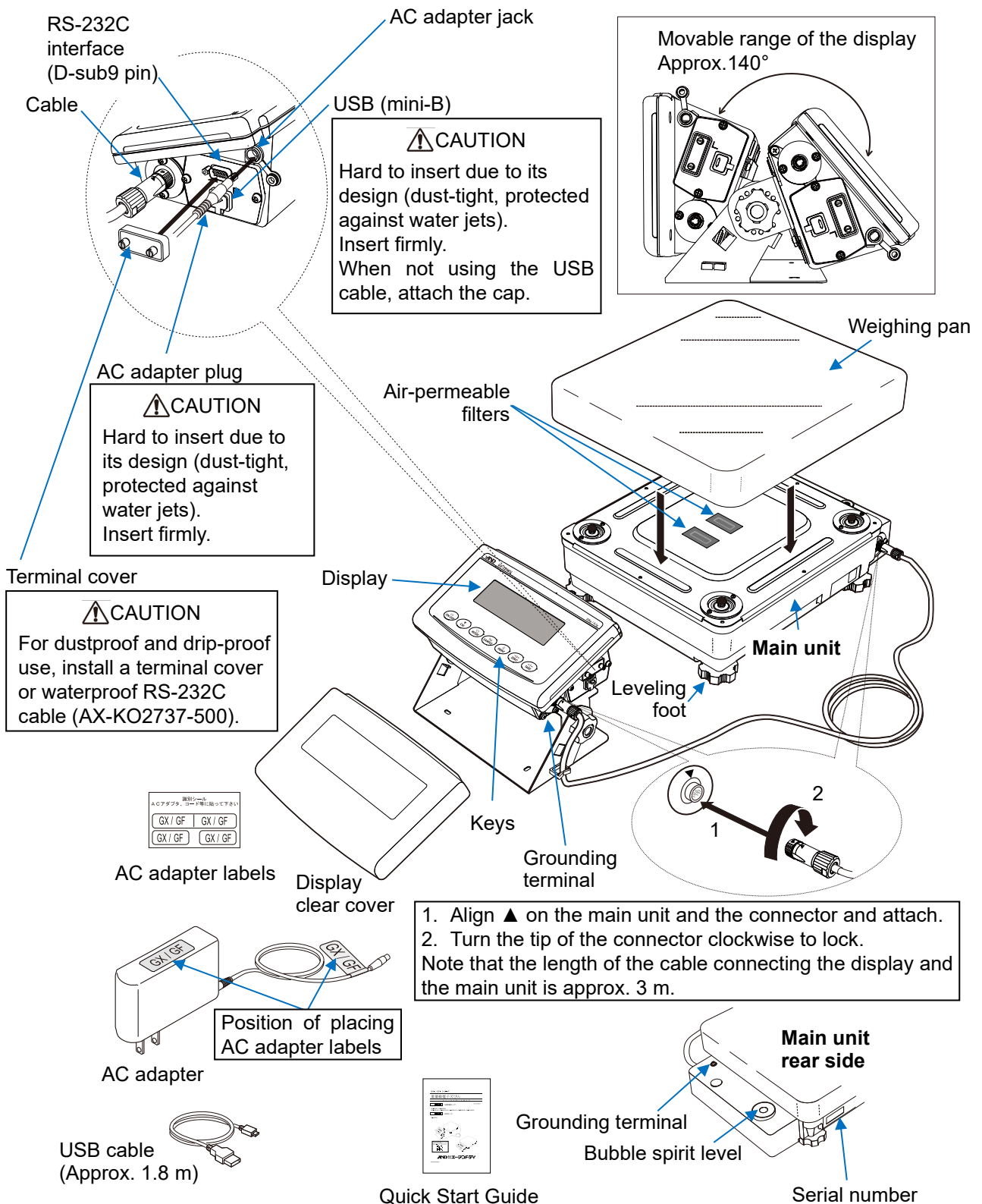

CAUTION

- Please confirm that the AC adapter type is correct for your local voltage and receptacle type.
- If there are multiple balances, make sure that the serial numbers of the balance and the display unit are the same and connect the cables. If the balance and display units with different serial numbers are connected, the balance will not operate properly.

2-1. Assembly and installation



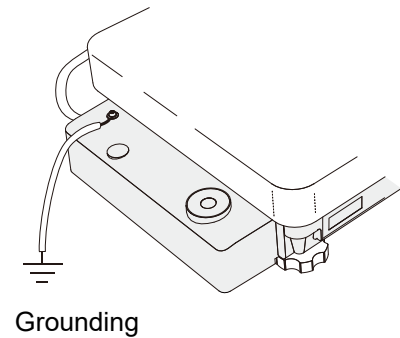
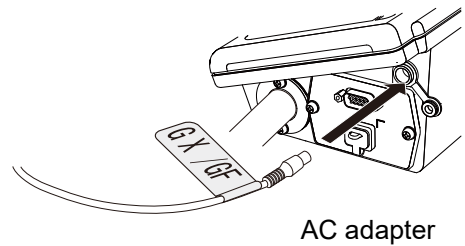
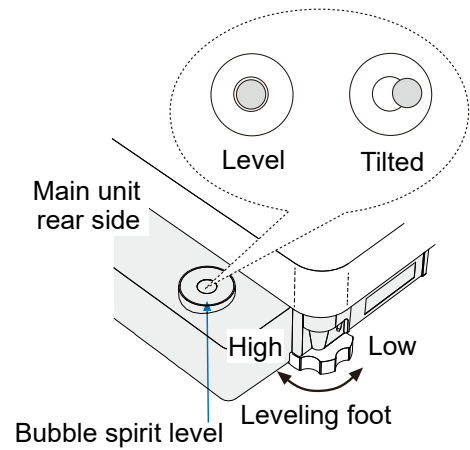

1. Consider the cautions described later regarding the place to install the balance.
2. Place the “weighing pan” on the main body of the balance. (See previous pages.)
3. Level the balance by adjusting the leveling feet so that the bubble of the bubble spirit level is centered in the circle. (See “[Adjusting the level of the balance](#)” on the next page.)
4. Insert the AC adapter into the AC adapter jack on the balance display unit, and insert the other plug into an outlet.
(For more precise measurements, ground and energize the balance for at least 30 minutes before use.)

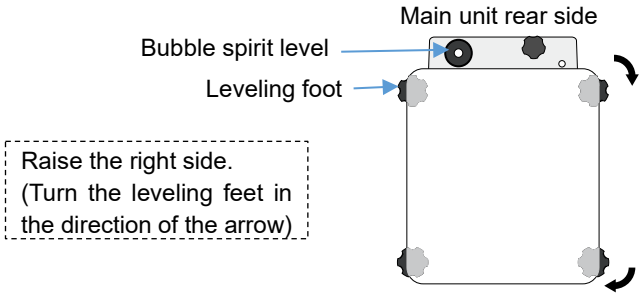

Adjusting the level of the balance

E.g. Procedure when the level is as follows:

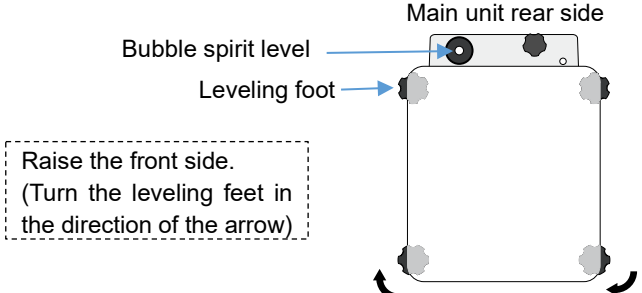
○ Center circle of the bubble spirit level ● Bubble

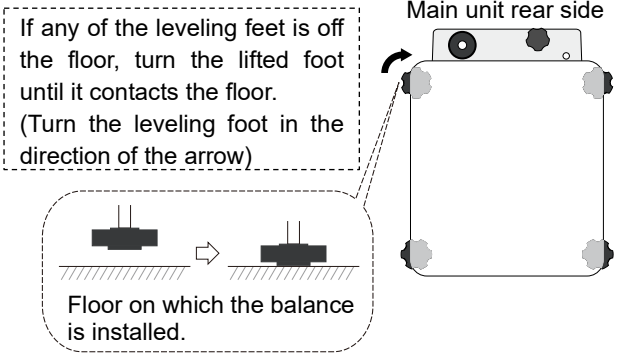
Bubble spirit level	Procedure	How to adjust the leveling feet
 <p>The left side of the balance main unit is tilted high.</p>	<p>Step 1 Adjust the left-right tilt:</p> <p>Turn the leveling feet to adjust the height. (In this example, the right side is raised as shown in the figure on the right.)</p>	
 <p>The rear side of the balance main unit is tilted high.</p>	<p>Step 2 Adjust the front-rear tilt:</p> <p>Turn the leveling feet to adjust the height. (In this example, the front side is raised as shown in the figure on the right.)</p>	
 <p>The balance is level.</p>	<p>Step 3 Check the leveling feet:</p> <p>Check that the leveling feet at the four corners are not lifting off the floor. If any of the leveling feet is off the floor, turn the lifted foot until it contacts the floor. Be careful not to misalign the bubble with the center circle.</p>	

Tips

- If the position of the bubble is misaligned significantly from the center circle of the bubble spirit level, E1LE will be displayed. In that case, adjust the bubble spirit level so that the bubble is inside the center circle of the bubble spirit level since the balance main unit may be tilted. Alternatively, press any key other than the ON:OFF key to cancel the E1LE display. Note that the E1LE display is no longer enabled after being canceled by pressing the key. To enable the E1LE display, unplug the AC adapter and plug it in again to turn off the power.
- By performing sensitivity adjustment, the current installation state is stored as level reference. For sensitivity adjustment, refer to "[7. Sensitivity Adjustment / Calibration Test](#)".

2-2. Precautions before use (Installation considerations and preparation)

Prepare the following installation conditions in order to bring out the full performance of the balance.

- ❑ This product is a high precision balance with a maximum resolution of 1/600,000. The balance tends to be susceptible to temperature changes, pressure fluctuations, vibration, drafts, and other factors at the installation site. In particular, during sensitivity adjustment with the internal weight, a weighing value that is one digit smaller than the readability of the balance is read, so be careful of the above error factors and perform weighing operations in a stable environment.
- ❑ The best operating temperature is about 20°C ±2°C at about 45% to 60% RH relative humidity.
- ❑ Install the balance where it is free of dust.
- ❑ Place the balance on a solid, flat floor. (Do not install on a soft floor.)
- ❑ The weighing table should be solid. (An anti-vibration table or stone table is ideal.)
- ❑ Make sure there is no tilt in the installation location.
- ❑ Install the balance in a stable location, avoiding vibration and shock. Corners of rooms on the first floor of a building, i.e. the floor which is level with the ground, are best as they are less prone to vibration.
- ❑ Install the balance where it is not affected by heaters or air conditioners. Avoid breezes and drafts in the room.
- ❑ Avoid locations in direct sunlight.
- ❑ Install the balance away from equipment which produces magnetic fields.
- ❑ Level the balance by adjusting the leveling feet so that the bubble of the bubble spirit level is centered in the circle.
- ❑ Be sure to warm up the balance before use for at least 30 minutes with the AC adapter connected to the power supply.
- ❑ When the balance is installed for the first time or has been moved, warm up the balance for at least 12 hours to allow the balance to reach equilibrium with the ambient temperature, and then perform sensitivity adjustment before use. For details, refer to “[7. Sensitivity Adjustment / Calibration Test](#)”.
- ❑ The balance’s dustproof and drip-proof rating is equivalent to IP65, and its second digit, “5”, corresponds to “having no harmful influence by receiving direct jet of water”. Washing with strong water pressure, washing with the weighing pan removed, or submersion in water may cause water to enter the balance, resulting in a malfunction.
- ❑ When installing and using the balance under conditions requiring dustproof and drip-proof performance, make sure that the weighing pan is installed on the main unit, that the cable for connecting the main unit and display unit is attached (for separate type models), that the AC adapter plug is fully inserted into the AC adapter jack, that the terminal cover is attached to the RS-232C interface or a waterproof RS-232C cable (AX-KO2737-500) is used, and that the USB waterproof cover cap is attached or the USB connector is firmly inserted.
- ❑ If the weighing pan or RS-232C terminal cover is removed or a waterproof RS-232C cable (AX-KO2737-500) is not used, protection against dustproof and water is not provided.
- ❑ Errors due to moving the weighing system:
 - The performance of this product is guaranteed when it is used in a stationary condition. If the balance is incorporated into a system that moves the balance, you must carefully perform checks in advance while paying attention to the following.
 - If the balance is moved, it may be damaged by impact shocks. In addition, the weighing value will be unstable immediately after the balance is moved. Avoid sudden movements, stops, or impact shocks,

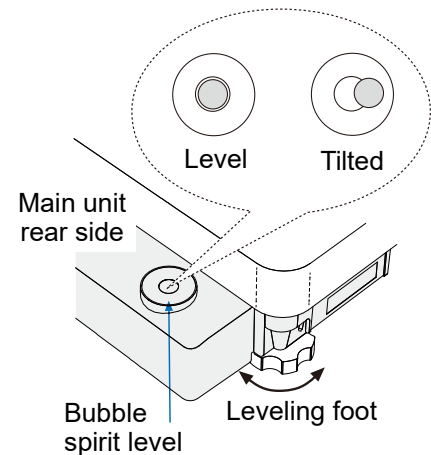

and provide a sufficient waiting time for the weighing value to stabilize when acquiring weighing data.

- The moving device should have a structure where the balance can be kept level. If the level is shifted, the zero point or sensitivity will be shifted, so perform re-zero operation or sensitivity adjustment.
- In order to avoid the influence of vibration, the moving platform should have a structure not easily susceptible to vibration by means such as reducing the play of moving parts.

CAUTION

- Please confirm that the AC adapter type is correct for your local voltage and receptacle type.
- Do not install the balance where flammable or corrosive gas is present.

2-3. Precautions during use (for more accurate weighing)

For precise and accurate weighing, please take notice of the following.

- Weighing errors may occur due to the influence of static electricity. Note that if the ambient humidity drops below 45%RH, insulators such as plastics are liable to have static electricity. Ground the balance and perform the following as needed.
 - Use the AD1683A ionizer (sold separately) to remove static electricity from the charged sample directly.
 - Increase the relative humidity at the place where the balance is installed.
 - Weigh the sample in a conductive metal container or the like.
 - Wipe off charged materials such as plastic with a damp cloth to suppress static electricity.
- Influence of magnetism may cause weighing errors. When measuring magnetic materials (iron, etc.), keep the sample away from the balance main body by means such as underhook weighing.
- Weighing errors may occur if there is a difference between the ambient temperature and temperature of the sample (and the container). For example, when the room temperature is 20 °C, convection occurs around a Petri dish or watch glass that is 40 °C and the balance displays a value lighter than the actual weight. Before weighing the sample and the container, try to acclimatize them to the ambient temperature.
- Perform the weighing operation carefully and quickly. If measurement takes a long time, error-inducing factors will increase due to changes in temperature and humidity in the weighing chamber, air turbulence or reaction/humidity absorption by the sample.
- When placing a sample on the weighing pan, do not drop it, or do not place a sample greater than the balance weighing capacity. Place the sample in the center of the weighing pan.
- When pressing keys, do not press with a sharp object such as a pen. Instead, press the center of the key with your finger.
- Be sure to press the **ZERO** key or **TARE** key before weighing in order to eliminate measurement errors.
- Measurement results include error from air buoyancy. The buoyancy of air varies depending on the sample volume, atmospheric pressure, temperature, and humidity. Correct the buoyancy for the most precise measurement.
- Prevent foreign substances such as powder, liquid, and metal pieces from entering the balance.

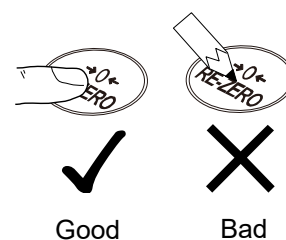
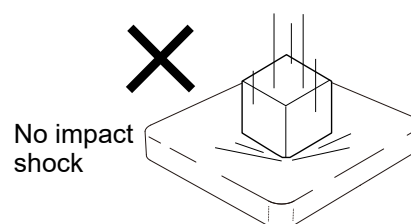
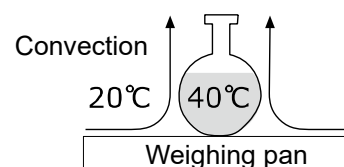
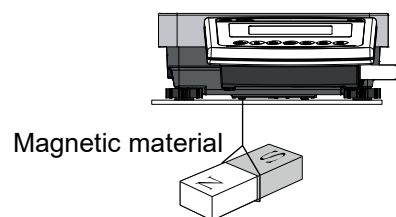
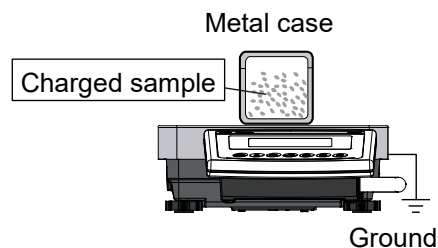

2-4. Cautions after use

- ❑ Avoid mechanical shock to the balance.
- ❑ Do not disassemble the balance. Prevent foreign substances such as powder, liquid and metal pieces from entering the balance.
- ❑ Do not use any strong organic solvents to clean the balance. Clean the balance with a lint free cloth that is moistened with a mild detergent.
- ❑ The weighing pan can be removed for easy cleaning around the pan.
When the weighing pan is removed, the air-permeable filters for pressure relief are exposed. Do not get the air-permeable filters wet.
- ❑ Do not allow the balance to be immersed in water. Even though the balance complies with IP65 (Dust-tight and Protected Against Water Jets), the balance will not withstand being completely immersed in water.

2-5. Caution on the power supply

- Do not remove the AC adapter while the internal weight is in motion, for example, right after the AC adapter is connected, or during sensitivity adjustment using the internal weight. If the AC adapter is removed under the conditions described above, the internal weight will be left unsecured, that may cause mechanical damage when the balance is moved. Before removing the AC adapter, press the ON:OFF key and confirm that zero is displayed.
- The balance is constantly provided with power as long as the AC adapter is connected.
The balance is not adversely affected in this state.
It is advisable to always keep the balance in this state for accurate weighing.

3. Display and Key Panel (Basic Operation)

Lit display

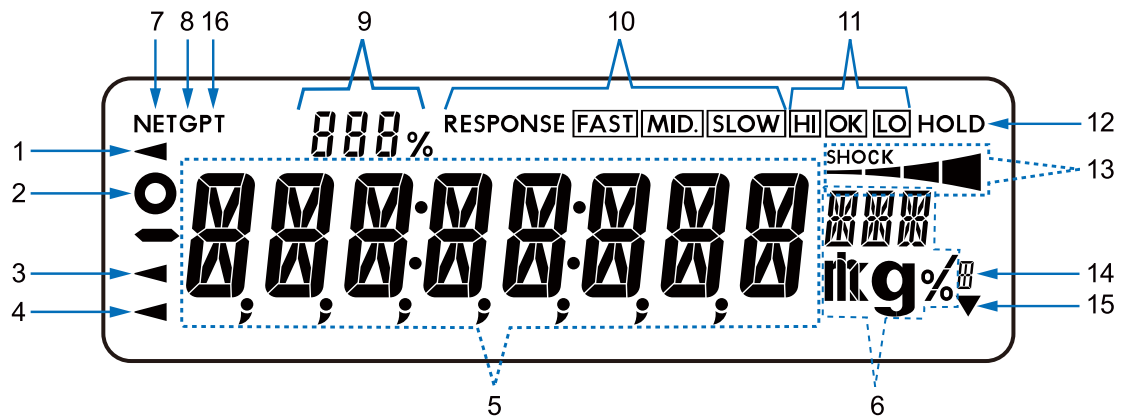

Blinking display

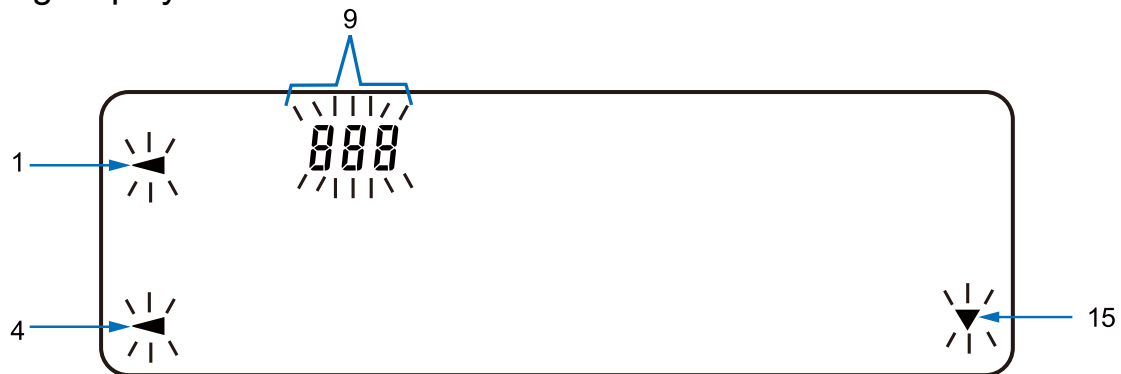

No.	Name
1	Processing indicator
2	Stabilization indicator
3	USB connection indicator
4	When lit: Standby indicator for power supply When blinking: Prior notice for automatic sensitivity adjustment
5	Displays weighing value, stored data, and setting item
6	Unit display
7	Net mark
8	Gross mark
9	Number of statistical data (statistical calculation function) Data memory number Load/capacity relationship in %. (Capacity indicator) Function table set value display
10	Response indicators (lights for 30 seconds after start of weighing)
11	Comparator indicators
12	Display hold mark
13	Impact shock detection (ISD) indicator
14	Gross zero mark
15	When lit: Interval output mode in standby When blinking: Interval output mode in operation
16	Preset tare mark

Key operation

Key operations affect how the balance functions.

Normal key operation during measurement is **“Press and release the key immediately”** or **“Press and hold the key for (approx.) 2 seconds”**.





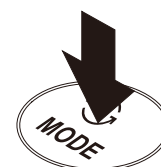

Please do not press and hold the key for (approx.) 2 seconds unless required.



Press the key
(Press and release the key immediately.)



Press and hold the key
for (approx.) 2 seconds.

Key	When pressed and released	When pressed and held (for 2 seconds)
	Turns the display on and off. When the display is turned off, only the standby indicator is displayed. When the display is turned on, weighing is possible. If the password function is enabled, you will be prompted to enter the password when the display is turned on. For details, refer to “16-2. Entering a password at the start of weighing” . The ON:OFF key is active at any time, and pressing this key during operation always turns off the display.	
	Performs sensitivity adjustment of the balance using the internal weight. (GX-L series only)	Displays the menu related to sensitivity adjustment.
	Switches the units of measure registered in the function table. Refer to “4. Weighing” .	Activates the self check mode. Refer to “6-2. Self check function / automatic setting of minimum weight with ECL” .
	<ul style="list-style-type: none"> □ In weighing mode, pressing this button turns on/off the readability digit. □ In counting or percent mode, pressing this button activates the sample storing mode. 	<ul style="list-style-type: none"> □ Activates the function table mode. Refer to “9. Function Table”. □ Runs the repeatability check function when pressed and held for another 2 seconds after the function table menu is displayed. Refer to “17. Repeatability Check Function (GX-L series only)”.
	Stores or outputs the weighing value when stable according to the function table settings. (At factory setting, data output is performed.)	<ul style="list-style-type: none"> □ In counting mode, pressing this key activates the mode to change the unit mass registration number. □ Depending on the function table settings: <ul style="list-style-type: none"> · Outputs "Title block" and "End block" in GLP/GMP format. · Displays the data memory function menu. · Activates mode for reading density number in flow rate measurement.
	Sets the displayed value to zero.	Refer to “Zero-point setting, tare subtraction operation, and weighing range” in “4-2. Basic operation” .
		

3-1. Smart range function

GX-32001LD and GX-32001LDS are equipped with two ranges (by combination of weighing range and readability). The precision range has a higher resolution. The standard range has normal resolution. The range is switched automatically, depending on the value displayed.

Placing a heavy load and pressing the **TARE** key allows weighing in the precision range. (Smart range function)

The range can be fixed to the standard range by pressing the **SAMPLE** key.

Caution

Once the range is switched to the standard range, it does not automatically return to the precision range even if the value becomes within the precision range. Use the **ZERO**, **TARE**, or **SAMPLE** key to switch to the precision range again.

GX-32001LD / GX-32001LDS, precision range 6.2 kg × 0.1 g / standard range 32.2 kg × 1 g

1. Press the **ZERO** key.

The balance will start weighing with the precision range.

2. Place a container on the weighing pan.

When the weighing value exceeds the precision range, the range will be switched to the standard range.

3. Press the **TARE** key.

The balance will be switched to the precision range.

4. Place a sample on the pan.

When the weighing value is within the precision range, the balance will weigh using the precision range.

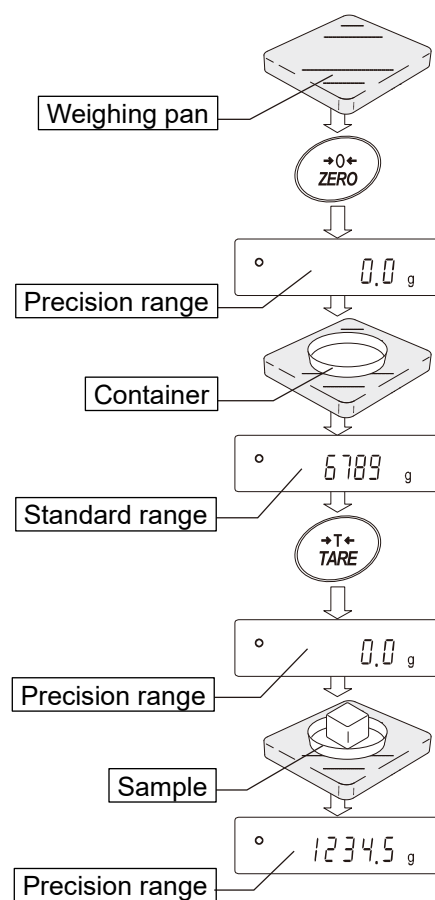

Precision range / standard range value

		Precision range (After the ZERO or TARE key is pressed)	Standard range
GX-32001LD	g	Up to 6200.9 g	6201 g or more
	kg	Up to 6.2009 kg	6.201 kg or more
GX-32001LDS	ct	Up to 31004.5 ct	31005 ct or more
	mom	Up to 1653.5 mom	1653.6 mom or more

Tip

- In tare subtraction operation, the maximum value that can be weighed when the **TARE** key is pressed is the net value (weighing capacity minus tare weight).

4. Weighing

4-1. The units of measurement

With the GX-L /GF-L series balance, the following weighing units and weighing modes are available:

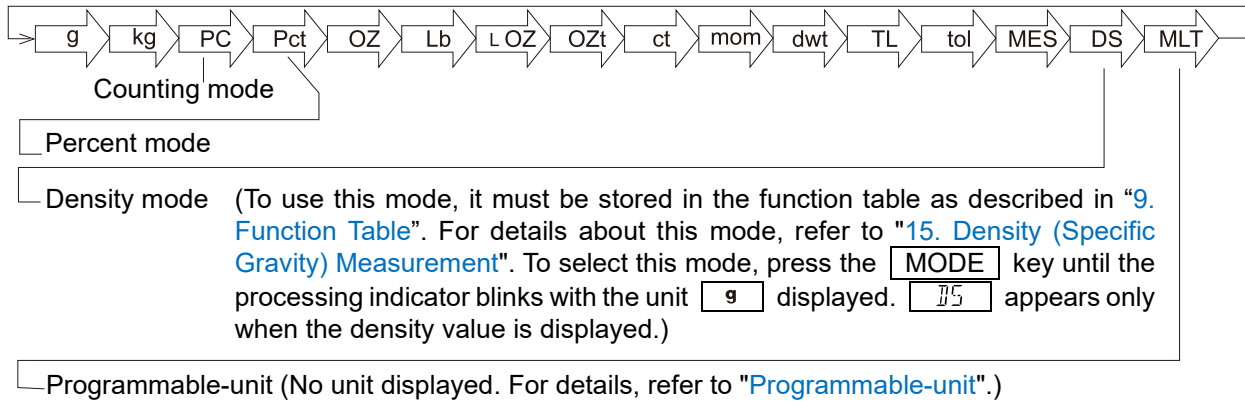

A unit or mode can be selected and stored in the function table as described in "9. Function Table". If a weighing mode (or unit of weight) has been turned off, that mode or unit will be missing in the sequence. Tael has four varieties, one of which can be selected and installed at the factory. To select a unit or mode for weighing, press the **MODE** key.

For details about the units and modes, see the table below:

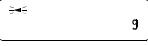
Name (unit, mode)	Abbrev.	Display	Function table (Storing mode)	Conversion factor 1 g =
Gram	g	g	g	1 g
Kilogram	kg	kg	kg	1000 g
Counting mode	PCS	<i>PCS</i>	<i>PCS</i>	_____
Percent mode	%	<i>%</i>	<i>%</i>	_____
Ounce (Avoir)	OZ	<i>OZ</i>	<i>OZ</i>	28.349523125 g
Pound	Lb	<i>Lb</i>	<i>Lb</i>	453.59237 g
Pound/Ounce	L OZ	<i>L OZ</i>	<i>LO</i>	1Lb=16 oz, 1 oz=28.349523125 g
Troy Ounce	OZt	<i>OZt</i>	<i>OZt</i>	31.1034768 g
Metric Carat	ct	<i>ct</i>	<i>ct</i>	0.2 g
Momme	mom	<i>mom</i>	<i>mom</i>	3.75 g
Pennyweight	dwt	<i>dwt</i>	<i>dwt</i>	1.55517384 g
Tael (HK general, Singapore)	TL	<i>TL</i>	<i>TL</i>	37.7994 g
Tael (HK jewelry)				37.429 g
Tael (Taiwan)				37.5 g
Tael (China)				31.25 g
Tola (India)	tol	<i>tol</i>	<i>tol</i>	11.6638038 g
Messghal	MES	<i>MES</i>	<i>MES</i>	4.6875 g
Density mode (See note below)	DS	 <i>DS</i> s used to show the density.	<i>DS</i>	_____
Programmable-unit (Multi-unit)	MLT	<i>ML t</i>	<i>ML t</i>	_____

Note

The blinking processing indicator with “g” indicates that the density mode is selected.

The following tables indicate the weighing capacity and the minimum display for each unit, depending on the balance model.

Unit		GX-12001L GF-12001L	GX-22001L GF-22001L	Readability
Unit		Capacity	Capacity	Readability
Gram	g	12000.0	22000.0	0.1
Kilogram	kg	12.0000	22.0000	0.0001
Ounce (Avoir)	oz	423.290	776.025	0.005
Pound	Lb	26.4555	48.5015	0.0005
Pound/Ounce	L oz	26L 7.29	48L 8.03	0.01
Troy Ounce	Ozt	385.810	707.315	0.005
Metric Carat	ct	60000.0	110000.0	0.5
Momme	mom	3200.00	5866.65	0.05
Pennyweight	dwt	7716.2	14146.3	0.1
Tael (HK general, Singapore)	TL	317.465	582.020	0.005
Tael (HK jewelry)	TL	320.605	587.780	0.005
Tael (Taiwan)	TL	320.000	586.665	0.005
Tael (China)	TL	384.000	704.000	0.005
Tola (India)	Tol	1028.82	1886.18	0.01
Messghal	Mes	2560.00	4693.35	0.05

		GX-32001L GF-32001L GX-32001LS	GX-62001L GX-62001LS	
Unit		Capacity	Capacity	Readability
Gram	g	32000.0	62000.0	0.1
Kilogram	kg	32.0000	62.0000	0.0001
Ounce (Avoir)	oz	1128.765	2186.985	0.005
Pound	Lb	70.5480	136.6865	0.0005
Pound/Ounce	L oz	70L 8.77	136L10.99	0.01
Troy Ounce	Ozt	1028.825	1993.345	0.005
Metric Carat	ct	160000.0	310000.0	0.5
Momme	mom	8533.35	16533.35	0.05
Pennyweight	dwt	20576.5	39866.9	0.1
Tael (HK general, Singapore)	TL	846.575	1640.240	0.005
Tael (HK jewelry)	TL	854.950	1656.470	0.005
Tael (Taiwan)	TL	853.335	1653.335	0.005
Tael (China)	TL	1024.000	1984.000	0.005
Tola (India)	Tol	2743.53	5315.59	0.01
Messghal	Mes	6826.65	13226.65	0.05

		GX-42001L	
Unit		Capacity	Readability
Gram	g	42000.0	0.5
Kilogram	kg	42.0000	0.0005
Ounce (Avoir)	oz	1481.50	0.02
Pound	Lb	92.594	0.002
Pound/Ounce	L oz	92L 9.50	0.02
Troy Ounce	Ozt	1350.34	0.02
Metric Carat	ct	210000	5
Momme	mom	11200.0	0.2
Pennyweight	dwt	27006.5	0.5
Tael (HK general, Singapore)	TL	1111.12	0.02
Tael (HK jewelry)	TL	1122.12	0.02
Tael (Taiwan)	TL	1120.00	0.02
Tael (China)	TL	1344.00	0.02
Tola (India)	Tol	3600.90	0.05
Messghal	Mes	8960.0	0.2

Unit		GX-62000L GF-62000L GX-62000LS	GX-102000L GX-102000LS	Readability
		Capacity	Capacity	
Gram	g	62000	102000	1
Kilogram	kg	62.000	102.000	0.001
Ounce (Avoir)	oz	2187.00	3597.95	0.05
Pound	Lb	136.685	224.870	0.005
Pound/Ounce	L oz	136L11.0	224L13.9	0.1
Troy Ounce	Ozt	1993.35	3279.40	0.05
Metric Carat	ct	310000	510000	5
Momme	mom	16533.5	27200.0	0.5
Pennyweight	dwt	39867	65588	1
Tael (HK general, Singapore)	TL	1640.25	2698.45	0.05
Tael (HK jewelry)	TL	1656.45	2725.15	0.05
Tael (Taiwan)	TL	1653.35	2720.00	0.05
Tael (China)	TL	1984.00	3264.00	0.05
Tola (India)	Tol	5315.6	8745.0	0.1
Messghal	Mes	13226.5	21760.0	0.5

Unit		GX-32001LD GX-32001LDS			
		Standard range		Precision range	
		Capacity	Readability	Capacity	Readability
Gram	g	32000	1	6200.0	0.1
Kilogram	kg	32.000	0.001	6.2000	0.0001
Ounce (Avoir)	oz	1128.75	0.05	218.700	0.005
Pound	Lb	136.6850	0.005	13.6685	0.0005
Pound/Ounce	L oz	70L 8.8	0.1	13L 10.70	0.01
Troy Ounce	Ozt	1028.800	0.05	199.335	0.005
Metric Carat	ct	160000	5	31000.0	0.5
Momme	mom	8533.5	0.5	1653.35	0.05
Pennyweight	dwt	20576	1	3986.7	0.1
Tael (HK general, Singapore)	TL	846.55	0.05	164.025	0.005
Tael (HK jewelry)	TL	854.95	0.05	165.645	0.005
Tael (Taiwan)	TL	853.35	0.05	165.335	0.005
Tael (China)	TL	1024.00	0.05	198.400	0.005
Tola (India)	Tol	2743.5	0.1	531.56	0.01
Messghal	Mes	6826.5	0.5	1322.65	0.05

Programmable-unit

This is a programmable-unit conversion function. It multiplies the weighing data in grams by an arbitrary coefficient set in the function table and displays the result.

The coefficient must be within the range between the minimum and maximum shown below. If the coefficient set is beyond the range, an error is displayed and the balance returns to the coefficient setting mode, prompting to enter an appropriate value. A coefficient of 1 was set at the factory.

Model	Minimum coefficient	Maximum coefficient
GX-12001L/22001L/32001L/32001LD/62001L GX-32001LS/32001LDS/62001LS GF-12001L/22001L/32001L	Model 0.000001	100
GX-42001L/62000L/102000L/62000LS/102000LS GF-62000L		10

Operation

1. Press and hold the **[SAMPLE]** key until **bASFnC** of the function table is displayed.
2. Press the **[SAMPLE]** key several times to display **MLE**.
3. Press the **[PRINT]** key. The balance enters the mode to confirm or set the coefficient.

Confirming the coefficient

4. The current coefficient is displayed with the first digit blinking.
 - When it is not to be changed, press the **[CAL]** key and proceed to step 6.
 - When it is to be changed, press the **[ZERO]** key and proceed to step 5.

Setting the coefficient

5. Set the coefficient using the following keys.

[SAMPLE] key Selects a digit to change the value.

The selected digit blinks.

[ZERO] key Changes the value.

[MODE] key Changes the decimal point position.

Each time the switch is pressed, the decimal point position changes as follows:

→ 0.000001 → 00.00001 → ... → 000000.1 → 0000001

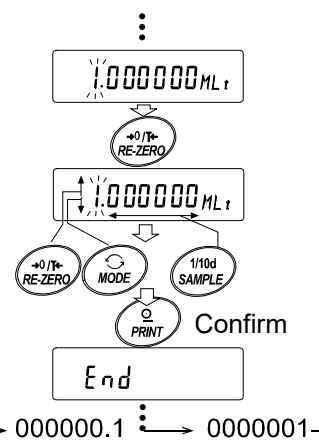

[PRINT] key Stores the new setting, displays **End** and proceeds to step 6.

[CAL] key Cancels the new setting and proceeds to step 6.

Quitting the operation

6. The balance displays **Unit**. Press the **[CAL]** key to exit the programmable-unit function and return to the weighing mode.

Using the function

Press the MODE key to select the programmable-unit (no display on the unit section). Perform weighing as described in “4-2. [Basic operation](#)”. After weighing, the balance displays the result (weighing data in grams × coefficient).

4-2. Basic operation

1. Press **MODE** key to select a unit of measure.
2. Place a container on the weighing pan if necessary. Press the **TARE** to display **0.0 g** (The decimal separator position depends on the balance model.)
3. Place a sample on the weighing pan or in the container. Wait for the stabilization indicator **◦** to be displayed. Read the value.
4. Remove the sample and container from the weighing pan.
 - Press the **SAMPLE** key to turn on or off the readability digit.

(This function works when the readability digit is after the decimal point.)

E.g.: 1268.7 g → 1269 g
 - The weighing data can be stored in memory by changing the function table. For details, refer to “11. Data Memory”.
 - If the **ON:OFF** key is pressed to start weighing with a container placed on the weighing pan, the balance automatically cancels the tare weight and displays zero.

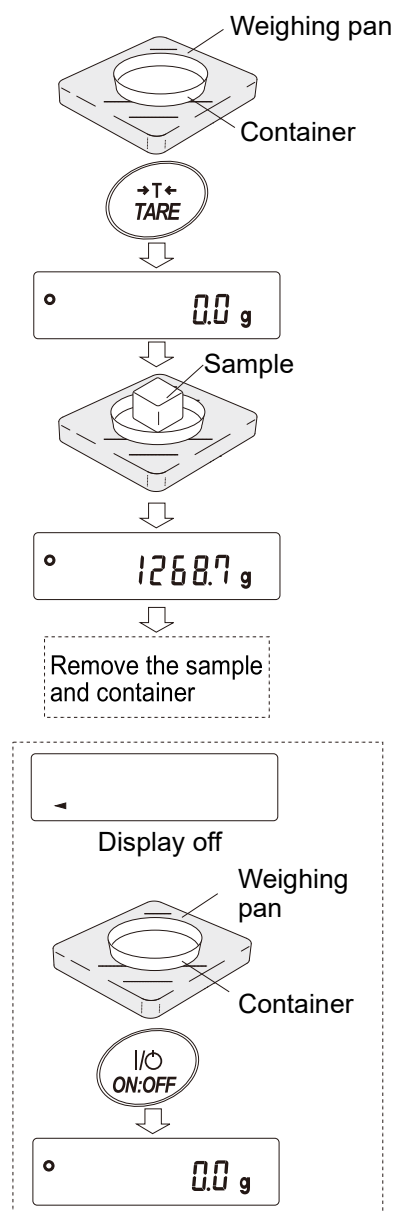

Zero-point setting, tare subtraction operation, and weighing range

□ At the start of weighing

The balance will decide the reference zero-point when the power is turned on with the **ON:OFF** key. Depending on the load condition at that time, the balance will automatically judge whether to perform zeroing or tare subtraction operation. The condition for determining which is used is "power on zero range", and when power on zero range is exceeded, the tare subtraction operation is performed.

□ Zero-point setting

From the reference zero point, when the weighing value is stable within the **ZERO** key operation range, pressing the **ZERO** key sets that point as the zero point.

□ Tare subtraction operation

When the weighing value is positive and stable, pressing the **TARE** key performs tare subtraction. The displayed value becomes zero and the **NET** mark appears. The **NET** mark is also displayed when the container (tare) is removed from the weighing pan during tare subtraction and the balance returns to the zero point. At this time, the display shows the tare value as a minus value.

Press the **TARE** key to clear the **NET** display.

□ Measurement range

Each balance series has a specific weighing range that can be displayed.

When the total amount (sum of net weight [weighing value after tare subtraction] and tare weight) up to the maximum display of each series exceeds the maximum display, "E" is displayed as over the weighing range. If it is minus, "-E" is displayed.

Series	Power on zero range	Zero range		-E display range
		ZERO key	TARE key	
GX-12001L, GF-12001L	Approx. -1 kg to +1 kg	Approx. -1 kg to +0.2 kg	Approx. -1 kg to 0 kg	Approx. less than -1 kg
GX-22001L, GF-22001L	Approx. -2 kg to +2 kg	Approx. -2 kg to +0.4 kg	Approx. -2 kg to 0 kg	Approx. less than -2 kg
GX-32001L, GF-32001L	Approx. -3 kg to +3 kg	Approx. -3 kg to +0.6 kg	Approx. -3 kg to 0 kg	Approx. less than -3 kg
GX-32001LD				
GX-32001LS,				
GX-32001LDS				
GX-42001L	Approx. -4 kg to +4 kg	Approx. -4 kg to +0.8 kg	Approx. -4 kg to 0 kg	Approx. less than -4 kg
GX-62001L,	Approx. -6 kg to +6 kg	Approx. -6 kg to +1.2 kg	Approx. -6 kg to 0 kg	Approx. less than -6 kg
GX-62001LS				
GX-62000L GF-62000L				
GX-62000LS				
GX-120000L	Approx. -12 kg to +12 kg	Approx. -12 kg to +2.4 kg	Approx. -12 kg to 0 kg	Approx. less than -12 kg
GX-120000LS				

4-3. Counting mode (PCS)

This is the mode to determine the number of objects in a sample. Based on the reference sample unit weight (weight per piece), the balance calculates and displays how many pieces the sample weight corresponds to. The smaller the variation in the unit weight of sample pieces is, the more accurate the count will be. The balance is equipped with the Automatic Counting Accuracy Improvement (ACAI) function to improve the counting accuracy.

- It is recommended that the unit weight (weight per piece) of the sample should be at least 10 times the gram readability of the balance.
- If there is a large variation in the unit weight of sample pieces, it may not be possible to count accurately.
- If a large error is found in the counting measurement, try a method such as performing ACAI function frequently or multiple measurements.

Selecting the counting mode

1. Press the **MODE** key to set the unit display to "PCS" (pieces).

Storing a sample unit weight

2. Press the **SAMPLE** key to enter the unit weight storing mode.

3. Select the number of sample pieces using the **SAMPLE** key.
(10 pcs → 25 pcs → 50 pcs → 100 pcs → 5 pcs)

Note that a greater number of sample pieces at time of unit weight storing will yield more accurate counting result since the sample unit weight is usually considered to vary slightly.

4. Place a container on the weighing pan, if necessary. Press the **TARE** key to set the display to **25 0**. (In this example, the number of sample pieces to store is set to 25.)

5. Place the displayed number of sample pieces on the weighing pan/container.

6. After the stabilization indicator lights up, press the **PRINT** key to store the unit weight. The balance displays the count. (In this example, **25 PCS** is displayed when 25 is set.)

- The balance prompts to add more sample pieces if it judges that the loaded sample is too light (resulting in large counting error). Add more sample pieces until the displayed number is reached, and then press the **PRINT** key again. When the unit weight is stored correctly, the balance displays the count.
- If the balance judges that the sample is too light to be stored as the unit weight, it displays **L0**.
- The stored unit weight is stored in nonvolatile memory even if the power is removed.

Counting mode

7. It is ready to perform counting operation with the stored unit weight.

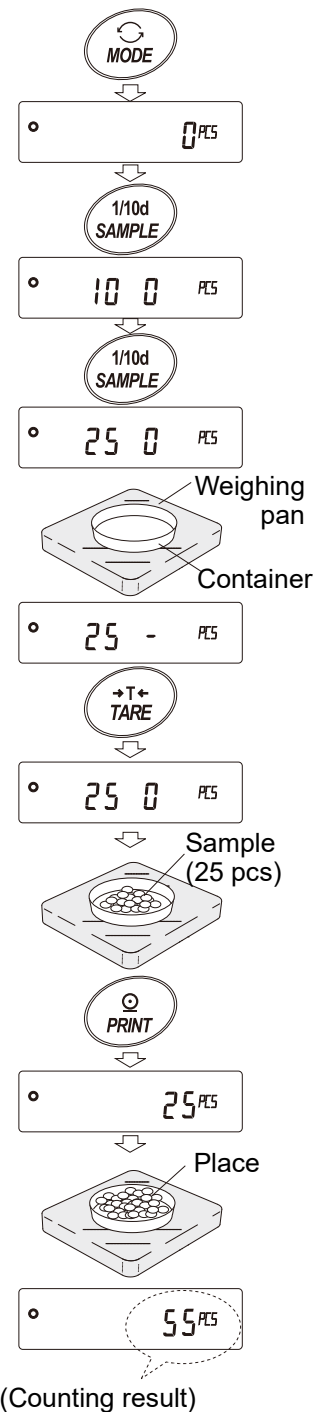

Automatic Counting Accuracy Improvement (ACAI)

This function automatically improves the counting accuracy each time the number of sample pieces is increased. (Errors will be reduced as variations in sample weight are averaged.)

After storing the unit weight in step 6, proceed to step 8 below.

8. Add a few sample pieces. The processing indicator then turns on. (Three or more pieces are required in order to prevent errors. The processing indicator does not turn on if overloaded. Add approximately the same number of sample pieces as displayed.)
9. Do not touch or move the sample pieces while the processing indicator is blinking. (The accuracy is being updated.)
10. The accuracy is updated after the processing indicator turns off. Each time this process is repeated, the counting accuracy will improve further. The range of ACAI after exceeding 100 is not predetermined. Add approximately the same number of sample pieces as displayed.
11. Remove all the sample pieces used with ACAI from the weighing pan and start counting work.

Note Do not change units during ACAI processing.

Processing indicator



Storing unit weights

By using the data memory function, up to 50 unit weights can be stored.

1. Set the "Data memory (DATA)" item of the function table to "Stores unit weight in counting mode (DATA 1)". Refer to "9. Function Table".
2. The displayed P^{**} is the selected unit weight registration number.
3. Press and hold the **PRINT** key for 2 seconds to enter the mode for changing the unit weight registration number.
 - ZERO** key ... Increases the value of registration number. (+)
 - MODE** key ... Decreases the value of registration number. (-)
 - PRINT** key ... Confirms the displayed registration number.
 - CAL** key ... Cancels the displayed registration number.
4. Multiple unit weights can be stored by assigning individual unit weight registration numbers.

Note P^{**} shows the selected unit weight registration number.

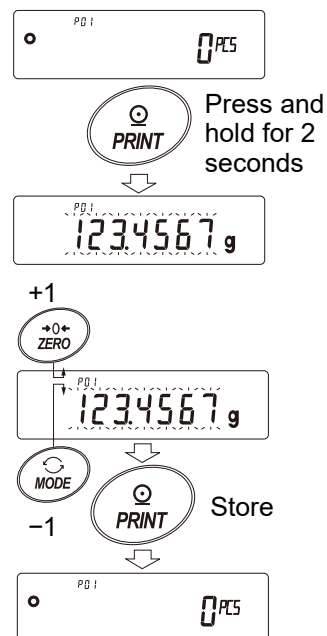

Note

- When the data memory function is being used, the unit weight can be read using the "UN: mm" command. In place of mm, a number from 01 to 50 enters (for P01 to P50)
- The read unit weight can be output with the "?UW" command and changed with the "UW: " command.

Caution

- The ACAI function does not work for the read unit weight.

4-4. Percent mode (Percent weighing mode)

The percent mode displays the weighing value in a percentage compared with a reference mass as 100%. This is useful for target weighing or sample variance checks.

Selecting the percent mode

1. Press the **MODE** key to select the unit **%** (percent mode).

Storing a reference mass as 100%

(Preparation for percent weighing)

2. Press the **SAMPLE** key to enter the mode for storing a 100% reference mass.

Note Even in registration mode, pressing the **MODE** key switches to the next mode.

3. Place a container on the weighing pan, if necessary. Press the **TARE** key to set the zero display to **100 0 %**.
4. Place a sample for the 100% reference mass on the weighing pan/container.
5. After the stabilization indicator lights up, press the **PRINT** key to store the 100% reference mass. The balance displays the stored 100% reference mass as **100.00 %**.

Caution

- **Lo** appears if the balance judges that the sample is too light to be stored as the 100% reference mass.
- The decimal separator position varies according to the 100% reference mass.

Model	100% reference mass	Decimal separator position
0.1 g readability	10.0 g - 99.9 g	1%
	100.0 g - 999.9 g	0.1%
	1000.0 g -	0.01%
1 g readability	10 g - 99 g	1%
	100 g - 999 g	0.1%
	1000 g - 9999 g	0.01%

Note The stored 100% reference mass is stored in nonvolatile memory even if the power is removed.

Percent weighing

6. It is ready to perform percent weighing with the stored 100% reference mass.

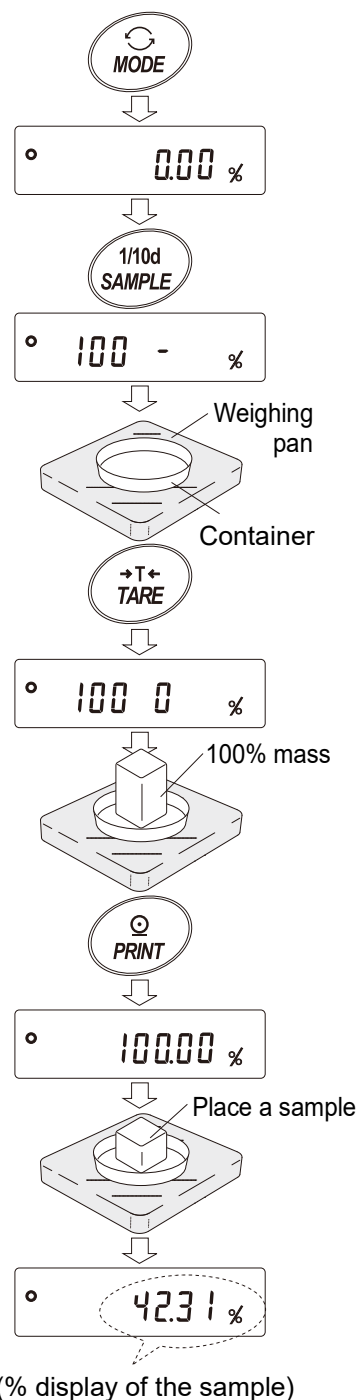

4-5. Animal weighing mode (Hold function)

Using the hold function, even if the weighing value fluctuates, such as when weighing an animal, the fixed average value can be displayed.

For details, refer to [“9. Function Table”](#) and [“9-3. Description of the class “Environment/Display”](#).





5. Impact Shock Detection (ISD) Function

The GX-L/GF-L series has a function to detect impact shocks to the mass sensor section and to display the impact level.

By lowering the impact level at the time of loading, it is possible not only to alleviate variation in the weighing value but also to reduce the risk of failure of the mass sensor section.

Especially when incorporating the balance in a production line, etc. and weighing by means such as an automated system, impact to the sensor may be applied greater than expected. When designing automatic systems and the like, it is recommended that you minimize the impact level as much as possible while checking the shock indicator.

The shock indicator has 5 levels from level 0 to level 4.

Impact level	Shock indicator	Buzzer	Contents
0	No indicator	No beeps	Safe
1	SHOCK 	No beeps	Caution
2	SHOCK 	No beeps	Caution: Alleviate impact shocks
3	SHOCK 	One beep	Warning: Do not apply any more impact shocks
4	SHOCK 	Two beeps	Danger: Sensor may be damaged.

You can turn off the impact shock detection function by setting to `bASFnC / 5d 0` in the function table.

Even if the impact shock detection function is turned off, a record is kept in the balance when there is a shock impact.

Caution

- Impact on the weighing sensor is not only that applied to the weighing pan when loaded, but also may be impact applied from the table on which the balance is installed. The impact detection function also works for impact coming from the table.

5-1. Recording impact history

Impacts of impact level 3 or higher are stored on the balance with data and time (up to 50 instances).

When the password lock function is ON (`Lack 1` or `2`), the login user information is added when outputting the impact history.

Caution

- If data instances exceed 50, the stored data with the lowest impact level will be overwritten.
- The stored impact history cannot be deleted.
- Impact data where the balance is not energized (during transport, etc.) is not stored.

5-2. Impact history output

The stored impact history can be output by sending a specified command to the balance or performing key operation.

Output by command

The stored impact data will be output all at once by sending a “?SA” command to the balance.

Output by key operation

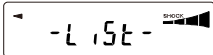
1. Press the **ON:OFF** key to turn off the display.
2. With the display off, press the **ON:OFF** key while holding down the **MODE** key.
3.  is displayed, and the stored impact data is output all at once.

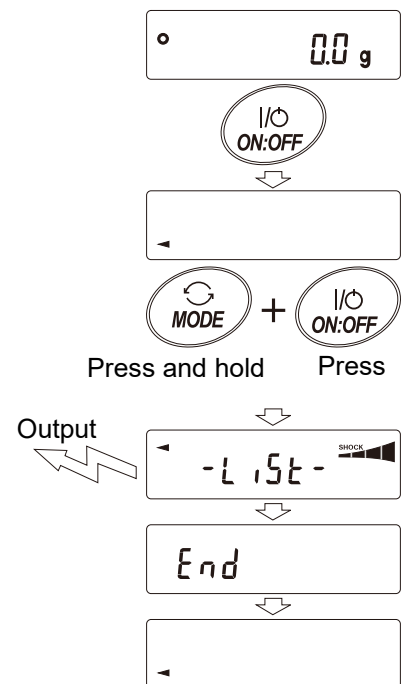

Impact history output example

Date, time, impact level and login user information are output together on one line.

The login user information varies depending on the setting of the login user and the setting of *Lack* in the function table when receiving impact.

Output	Login user	Function table <i>Lack</i>
,--,	No login user	0, 1, 2
,00,ADMIN	Administrator	1
,01~10,USER	User	1
,--,GUEST	Guest	2

Output example

```
2023/05/29,11:08:18,SHOCK LV,3,--,
2023/05/29,11:12:27,SHOCK LV,4,00,ADMIN
2023/05/29,11:13:38,SHOCK LV,3,01,USER
2023/05/29,11:17:04,SHOCK LV,4,--,GUEST
```

6. Response Adjustment / Self-check Function

Disturbances such as draft and vibration at the place where the balance is installed affect weighing. In the response adjustment settings, the response characteristics of the balance can be set in three stages according to the disturbance. The self-check function checks the operation of the balance by itself to check the performance.

Indicator	Function table	Response characteristic
FAST	[ond 0]	Fast response, Low display stability
MID	[ond 1]	<div style="display: flex; justify-content: space-around; align-items: center;"> ↑ ↓ </div>
SLOW	[ond 2]	Slow response, High display stability

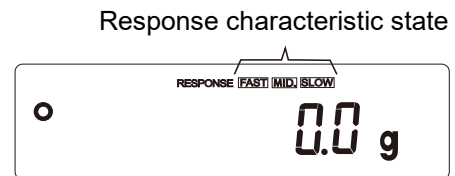

6-1. Response adjustment

Response adjustment can be changed by the following method.

1. Press and hold the **MODE** key for 2 seconds until **RESPONSE** is displayed, and then press the **MODE** key again.
2. Press the **MODE** key to select the desired setting. (**FAST**, **MID**, or **SLOW** can be selected.)
3. Wait until **End** is displayed. Then, the balance returns to weighing mode and displays the updated response indicator for a moment (for about 30 seconds).

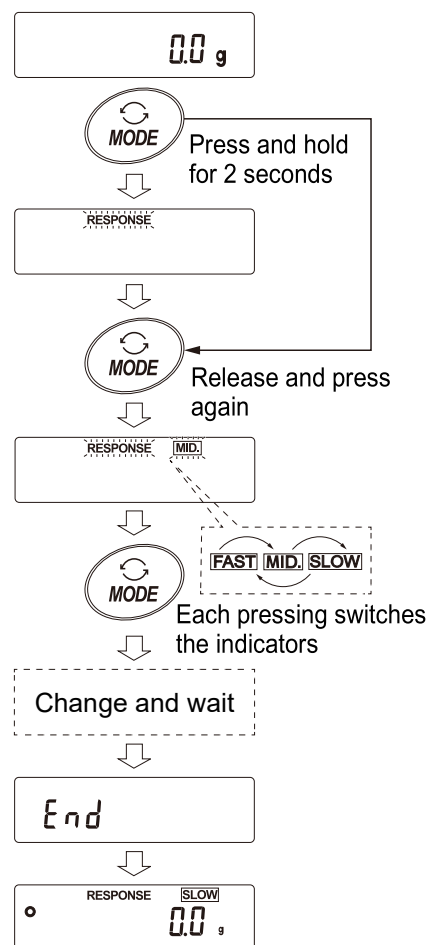

Information

When the response adjustment is set, "Condition (**Cond**)", "Display refresh rate (**SPd**)", and "Stability band width (**St-b**)" in "Basic Function (**bASFnC**)" of the function table are changed as shown below.

Display	Cond (Condition)	SPd (Display refresh rate)	St-b (Stability band width)
FAST	0	2	2
MID	1	0	1
SLOW	2	0	1

To use in a combination other than the above, set individually in the function table.

For the setting method, refer to "9. Function Table".

Caution

- If **RESPONSE** is displayed and you leave without pressing the **MODE** key, the self check function is activated.

For details on operation, refer to "6-2. Self check function / automatic setting of minimum weight with ECL".

6-2. Self check function / automatic setting of minimum weight with ECL

With the self check function, repeatability can be confirmed and displayed in addition to performing failure diagnosis, and whether or not the balance's performance is being exhibited can be easily checked. It is also possible to display and register the minimum weight (reference value) using repeatability data. For details of the minimum weight, refer to the technical information on A&D website (<https://www.aandd.jp>).

Setting procedure (See also the setting flowchart on the next page.)

1. Press and hold the **MODE** key for 2 seconds in weighing mode.
2. Release the key when the **RESPONSE** display blinks.
3. **[H>.....]** appears, and the self check function starts. **ECL** will be displayed in a few seconds.
If the **MODE** key is pressed when the **[H>.....]** is displayed, changes in weighing values in the repeatability measurement using electronic control load (ECL) can be seen.
4. When the diagnosis is completed, the diagnosis result is displayed. If there are no problems inside the balance, **[H PASS]** displays blinking.
If **[H FAIL]** displays blinking, there is a possibility that a fatal fault has occurred inside the balance. In this case, please contact your local A&D dealer for repair.
SAMPLE key Switches the display between diagnostic result, repeatability, and minimum weight (reference value).
PRINT key Outputs the displayed content.
When repeatability is displayed, **OK** lights if the specifications are met. If the specifications are exceeded, **Err** displays blinking and a request for review of the installation environment is issued.
MODE key Switches the measurement tolerance of minimum weight (reference value)

With the minimum weight (reference value) displayed, the following operations can be performed with the keys.

5. Batch output of the minimum weight data
Press and hold the **PRINT** key for 2 seconds to display **OUT**. When batch output is completed, **End** will be displayed.
6. Registration of the minimum weight (reference value) described in “14. Minimum Weight Alert Function”.
Press and hold the **SAMPLE** key for 2 seconds to display **MW SET** and to register the minimum weight (reference value). When registration is completed, **End** will be displayed, and then the balance returns to weighing mode.
7. No registration
Press the **CAL** key to display **End**. The balance returns to weighing mode.
8. Diagnostic result display
Press the **SAMPLE** key to return to the diagnostic result display (step 4).

* For the minimum weight alert function, refer to “14. Minimum Weight Alert Function”.

Setting procedure flowchart

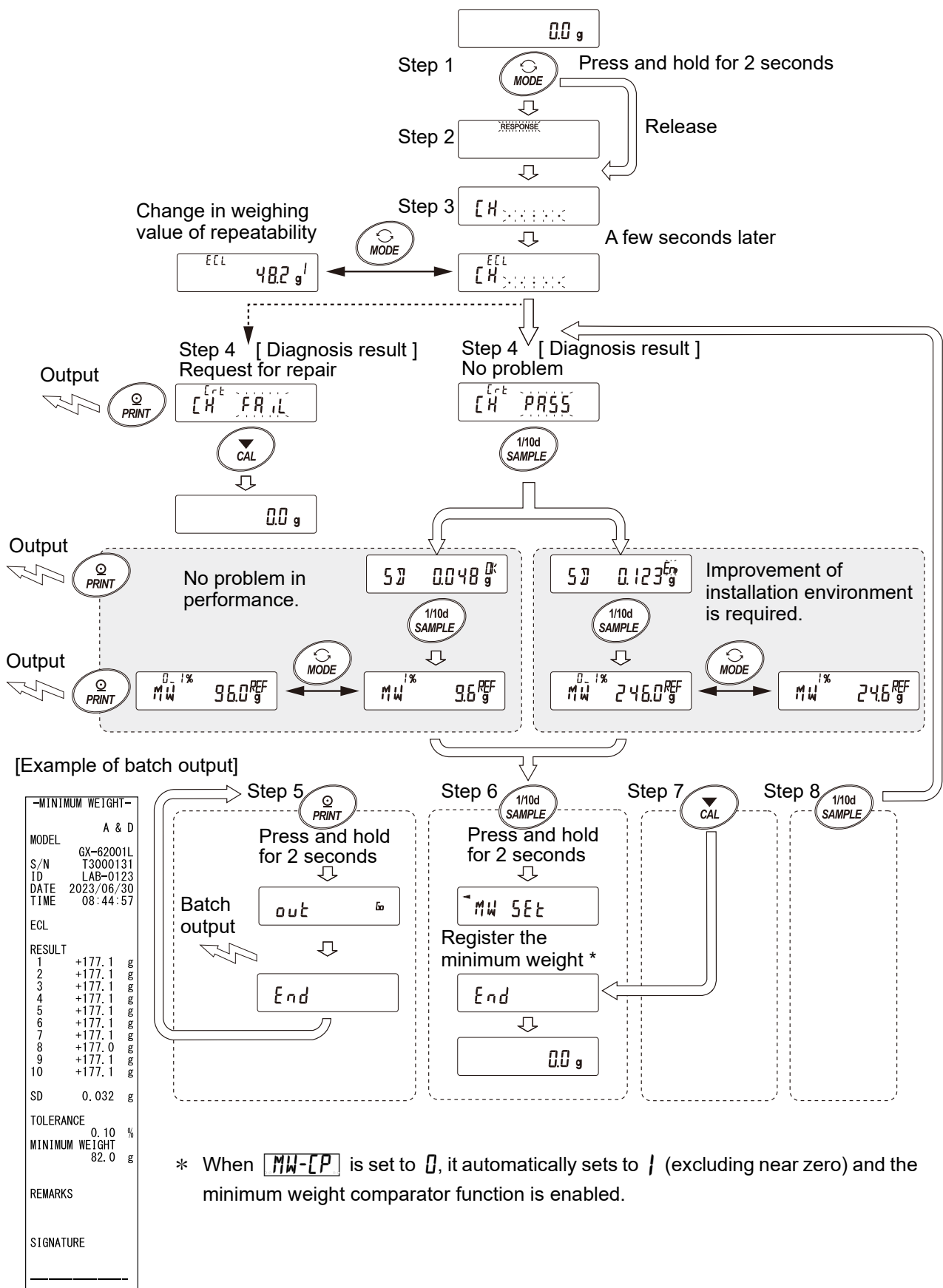

7. Sensitivity Adjustment / Calibration Test

Since the balance's resolution is high, weighing values may change due to gravity and daily environmental changes. It is necessary to perform sensitivity adjustment with the weight in order to keep the weighing values from changing even if gravity or the environment changes.

It is recommended that you perform sensitivity adjustment if the balance is installed for the first time or relocated, or when the weighing values change significantly in daily inspection, etc.

Sensitivity adjustment means to adjust the weighing value of the balance using the reference weight or internal weight. Calibration test is to weigh with the reference weight and compare how much the result deviates from the reference value. (Sensitivity adjustment is not performed in calibration test.)

Sensitivity adjustment

Automatic sensitivity adjustment -----Automatically adjusts the balance using the internal weight according to ambient temperature change/interval time. (GX-L series)

Sensitivity adjustment using the internal weight -----Using the internal weight, adjusts the balance with one key press.

Sensitivity adjustment using an external weight -----Using an external weight, adjusts the balance.

Calibration test

Calibration test using an external weight -----Outputs the result of the weighing accuracy check using an external weight.

*** No sensitivity adjustment is performed.**

Cautions on sensitivity adjustment

- ❑ Do not allow vibration or drafts to affect the balance during sensitivity adjustment.
- ❑ When outputting the maintenance report compliant with GLP, GMP, etc. during sensitivity adjustment:
To output the maintenance report compliant with GLP, GMP, etc., "GLP output (*INF*)" of "Data output (*DATA*)" in the function table must be set. GLP output requires a PC or optional printer. For GLP output, the balance's clock function will output the date and time. Refer to "9-4. Clock and calendar function" in "9. Function Table" and set the clock if the date and time are not correct.
Note that the calibration test function is available only when output of the maintenance report compliant with GLP, GMP, etc. is set.
- ❑ To store in memory the sensitivity adjustment report or calibration test report, "Data memory (*DATA*)" in the function table must be changed.

Cautions on the use of external weights

- ❑ The accuracy of the weight used for sensitivity adjustment determines the accuracy of the balance after sensitivity adjustment.
- ❑ Refer to the table on the next page to select the weight to be used for the sensitivity adjustment/calibration test using an external weight.

Series	Usable weight	Factory setting	Adjustable range
GX-12001L GF-12001L	5 kg, 10 kg	10 kg	-5.0 g to +5.0 g
GX-22001L GF-22001L	5 kg, 10 kg, 20 kg	20 kg	
GX-32001L GF-32001L GX-32001LS	5 kg, 10 kg, 20 kg, 30 kg	20 kg	
GX-32001LD GX-32001LDS	5 kg, 10 kg, 20 kg, 30 kg	20 kg	
GX-42001L	10 kg, 20 kg, 30 kg, 40 kg	40 kg	
GX-62001L GX-62001LS	10 kg, 20 kg, 30 kg, 40 kg, 50 kg, 60 kg	60 kg	
GX-62000L GF-62000L GX-62000LS	10 kg, 20 kg, 30 kg, 40 kg, 50 kg, 60 kg	60 kg	-50 g to +50 g
GX-102000L GX-102000LS	10 kg, 20 kg, 40 kg, 50 kg, 60 kg, 80 kg, 100 kg	100 kg	

Display



This indicator means the balance is measuring sensitivity adjustment data/calibration test data. Do not allow vibration or drafts to affect the balance while this indicator is displayed.

7-1. Automatic sensitivity adjustment (GX-L series only)

This function automatically adjusts the sensitivity of the balance according to ambient temperature change, set time or interval time using the internal weight. It works even when the display is off. After sensitivity adjustment, the balance will output the "sensitivity adjustment report" if GLP output is set in the function table.

- For the automatic sensitivity adjustment mode, "Temperature change ([Fnc 0])", "Set time ([Fnc 1])", or "Interval time ([Fnc 3])" can be set in "Sensitivity adjustment mode ([Fnc])" of the function table.
- For the set time, [t ME 1], [t ME 2], and [t ME 3] are available in the function table.
- The Interval time can be set in the range of 0.5 hours to 24 hours in "Interval time ([int])" of the function table.

Caution

- If something is on the weighing pan, the balance itself will judge that it is in use and will not perform automatic sensitivity adjustment. The criteria for performing automatic sensitivity adjustment are as follows.

0.1 g model	1 g model
200 g or more	2 kg or more

To maintain the correct sensitivity adjustment of the balance, do not place anything on the weighing pan while not in use.



The automatic sensitivity adjustment notice (the indicator ◀ blinking) indicates that the automatic sensitivity adjustment will start. If the balance is not in use, after blinking for a while, the balance will start automatic sensitivity adjustment using the internal weight. (The blinking duration depends on the environment.)



Indicates that the balance is measuring sensitivity adjustment data.

Do not allow vibration or drafts to affect the balance while this indicator is displayed. After calibration, the balance returns to indicate the previous display.

- If the balance is determined to be tilted, automatic sensitivity adjustment will not be performed. Check the bubble spirit level to see if the bubble is in the center circle.

Note that if the automatic level detection & warning is set to off (LV-DEC 0) in the function table bASFnc, automatic sensitivity adjustment is performed even if the balance is tilted.

Tips

- Although it is possible to continue using the balance even while the automatic sensitivity adjustment notice (the ◀ indicator) is blinking, use after sensitivity adjustment is completed is advisable in order to maintain the weighing accuracy.

"Prohibit automatic sensitivity adjustment" or "Allow automatic sensitivity adjustment" can be selected in the setting described in "8. Function Selection Switch and Initialization".

7-1-1. Inputting the set time

1. Press and hold the **SAMPLE** key for 2 seconds to display **bRSFnc**.
2. Press the **SAMPLE** key several times to display **Auto CAL**.
3. Press the **PRINT** key to display **[Fnc]**.
4. With **[Fnc]** displayed, press the **ZERO** key several times to display **[Fnc] t.ME**.
5. Press the **SAMPLE** key to display the set time 1 **[t.ME 1]**.
6. Press the **PRINT** key to enter the set time 1 setting mode.
7. With **BFF --:-- TMI** displayed, press the **ZERO** key.
The currently set time is displayed.
8. Using the following keys, set the time (in 24-hour format) to perform sensitivity adjustment.
ZERO (+) key ... Changes the value of the blinking digit.
MODE (-) key ... Changes the value of the blinking digit.
SAMPLE key ... Selects the digit to blink.
PRINT key ... Stores the new time setting.
CAL key ... Cancels the new time setting.
9. Press the **PRINT** key to display **End**.
10. To set the set time 2, display the set time 2 and repeat the steps 6 to 9.
11. To return to weighing mode, press the **CAL** key twice.

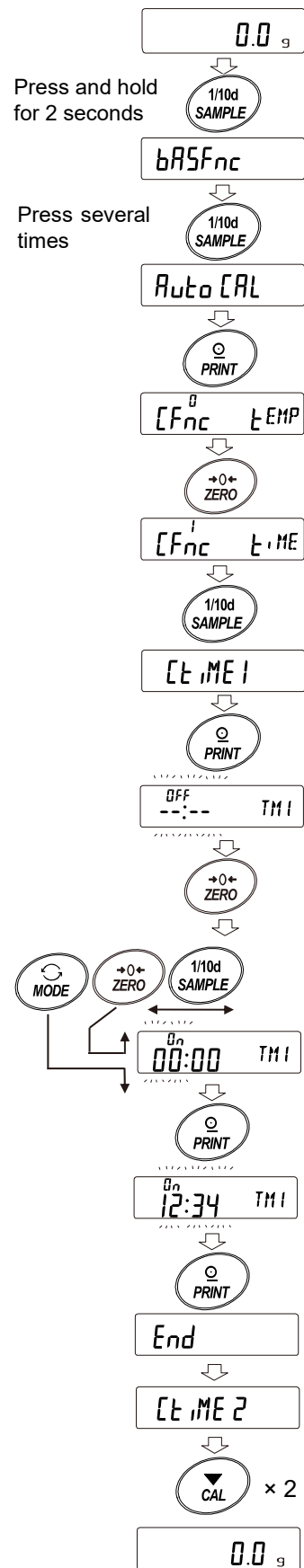

7-1-2. Clearing the set time

1. Refer to steps 1 to 5 in “7-1-1. Inputting the set time” to display **[t ME1]**.
2. Press the **[PRINT]** key to display the currently set time.
3. Press the **[MODE]** key to display **OFF ---:-- TMI**.
4. Press the **[PRINT]** key to display **End**.
5. Press the **[CAL]** key twice to return to weighing mode.

Refer to steps 1 to 5 on the previous page

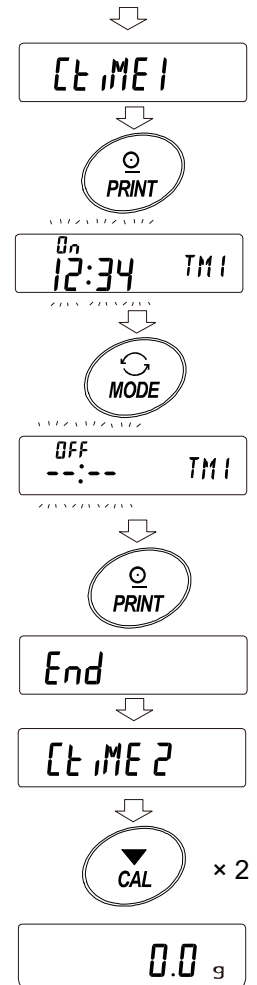

7-1-3. Setting the interval time

1. Press and hold the **SAMPLE** key for 2 seconds to display **bASFnC**.
2. Press the **SAMPLE** key several times to display **Auto CAL**.
3. Press the **PRINT** key to display **[FnC]**.
4. With **[FnC]** displayed, press the **ZERO** key several times to display **[FnC² int]**.
5. Press the **SAMPLE** key to display **[int]**.
6. Press the **ZERO** key several times to set the interval time (0.5 hours to 24 hours) to perform sensitivity adjustment. For the correspondence between the set value and interval time, refer to the correspondence table on the next page.
7. Press the **PRINT** key to display **End**.
8. Press the **CAL** key to return to weighing mode.

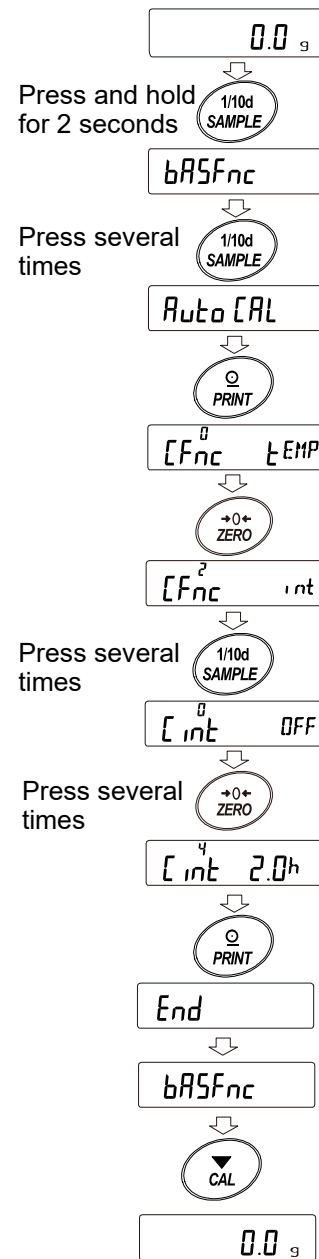

Correspondence table between the set value and interval time of the item [int].

Item	Parameter	Description
[int]	0	Off
	1	0.5-hour interval time
	2	1.0-hour interval time
	3	1.5-hour interval time
	4	2.0-hour interval time
	5	2.5-hour interval time
	6	3.0-hour interval time
	7	3.5-hour interval time
	8	4.0-hour interval time
	9	4.5-hour interval time
	10	5.0-hour interval time
	11	5.5-hour interval time
	12	6.0-hour interval time
	13	7.0-hour interval time
	14	8.0-hour interval time
	15	9.0-hour interval time
	16	10.0-hour interval time
	17	11.0-hour interval time
	18	12.0-hour interval time
	19	14.0-hour interval time
	20	16.0-hour interval time
	21	18.0-hour interval time
	22	20.0-hour interval time
	23	22.0-hour interval time
24	24.0-hour interval time	

7-2. Sensitivity adjustment using the internal weight (GX-L series only)

Sensitivity adjustment using the internal weight can be performed with one key press.

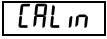
1. Be sure to warm up the balance with nothing on the weighing pan for at least half an hour with the AC adapter connected to the power supply.
2. Press the CAL key. The balance displays .
3. The balance automatically performs sensitivity adjustment using the internal weight. Do not apply vibration and the like to the balance.
4. After sensitivity adjustment, the balance will output the “sensitivity adjustment report” if GLP output is set in the function table.
5. The balance returns automatically to weighing mode.

Caution

About the internal weight

The value of the internal weight may change due to factors such as the operating environment and aging. Correct the internal weight value as necessary by referring to [“7-6. Correcting the internal weight value \(GX-L series only\)”](#).

The internal weight is approximately 1 kg. The greater the weighing capacity, the greater the deviation may be. In order to maintain the weighing accuracy, it is advisable to perform sensitivity adjustment regularly by referring to [“7-4. Calibration test using an external weight”](#)



This indicates that the balance is importing sensitivity adjustment data.

Do not allow vibration or drafts to affect the balance while this indicator is displayed.

After the sensitivity adjustment, the balance returns to the previous display.

7-3. Sensitivity adjustment using an external weight

This function performs sensitivity adjustment of the balance using your external weight.

1. Warm up the balance with nothing on the weighing pan for at least half an hour with the AC adapter connected to the power supply.

2. Press and hold the **[CAL]** key for 2 seconds until **[CAL out]** is displayed, then release the key.

[CAL in] is displayed only on the GX-L series. **[CAL H/S]** is displayed only when set. Refer to "11-2. Data memory for sensitivity adjustment and calibration test".

3. Make sure that nothing is on the weighing pan and press the **[PRINT]** key.

The balance measures the zero point. Do not apply vibration and the like to the balance.

4. Place the external weight on the weighing pan and press the **[PRINT]** key.

The balance measures the value. Do not apply vibration and the like to the balance.

5. Remove the external weight from the weighing pan.

6. After sensitivity adjustment, the balance will output the "sensitivity adjustment report" in GLP compliant format or store the data in the data memory as set in the function table.

7. The balance returns automatically to weighing mode.

8. Place the external weight on the weighing pan again to check if it is within the set value $\pm 2 d^*$.

If it is not within the range, start over from the first step of this procedure in the appropriate ambient conditions.

*1 "d" (readability digit) is the unit of readability.

For example, if the readability is 0.1 g, 1 d is 0.1 g.

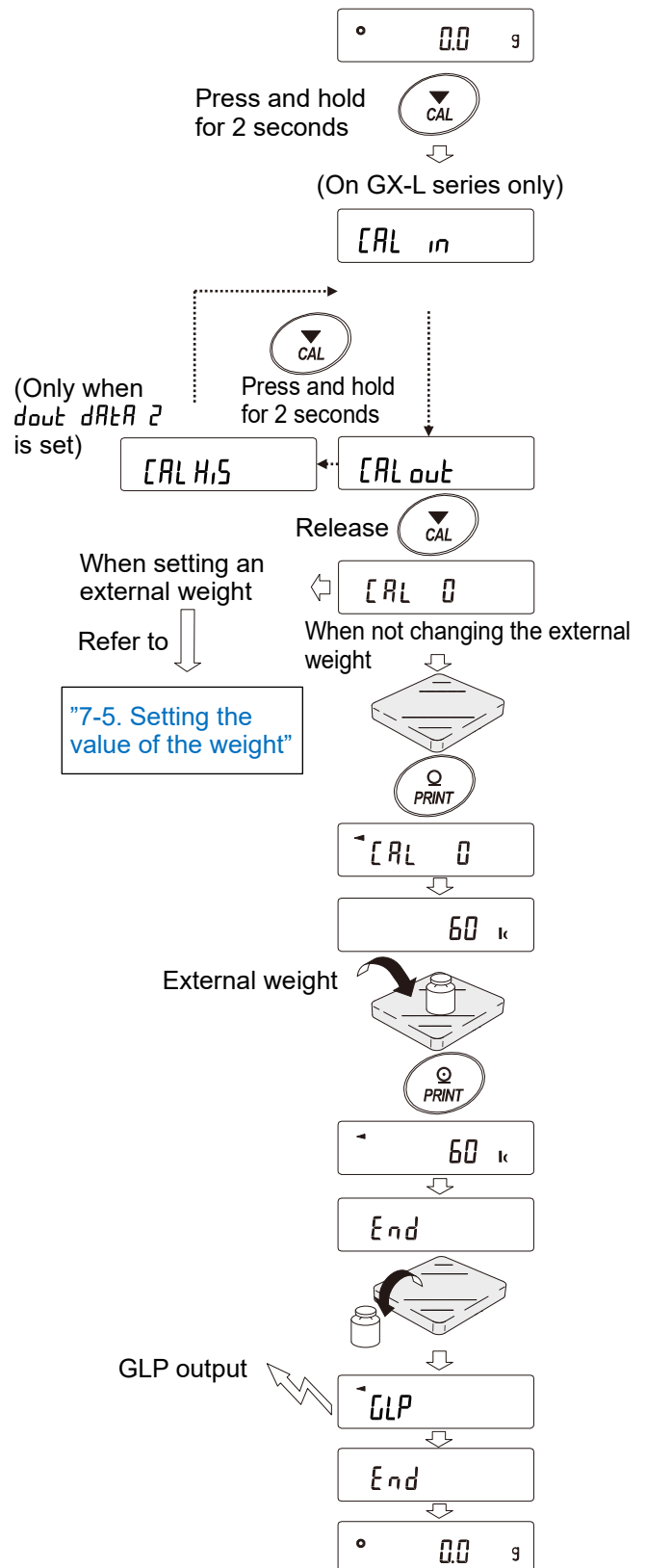

7-4. Calibration test using an external weight

The balance checks the accuracy of weighing using your external weight and outputs the result.

This function is available only when the output of GLP/GMP (etc.) compliant report for check result (*dout inf 1* or *2*) is set.

(Note that calibration test does not perform sensitivity adjustment.)

1. Warm up the balance with nothing on the weighing pan for at least half an hour with the AC adapter connected to the power supply.

2. Press and hold the **CAL** key for 2 seconds. When **[[out** is displayed, release the key.

CAL in is displayed only on the GX-L series.

CAL H/S is displayed only when set.

Refer to "11-2. Data Memory for Sensitivity Adjustment and Calibration Test".

3. Make sure that nothing is on the weighing pan and press the **PRINT** key.

The balance measures the zero point. Do not apply vibration and the like to the balance.

4. The measured value of the zero point is displayed for a few seconds.

Place the external weight on the weighing pan and press the **PRINT** key.

The balance measures the value. Do not apply vibration and the like to the balance.

5. The measured value of the external weight is displayed for a few seconds.

6. Remove the weight from the weighing pan.

7. The balance will output the "calibration test report" or store the data in the data memory.

8. The balance automatically returns to weighing mode.

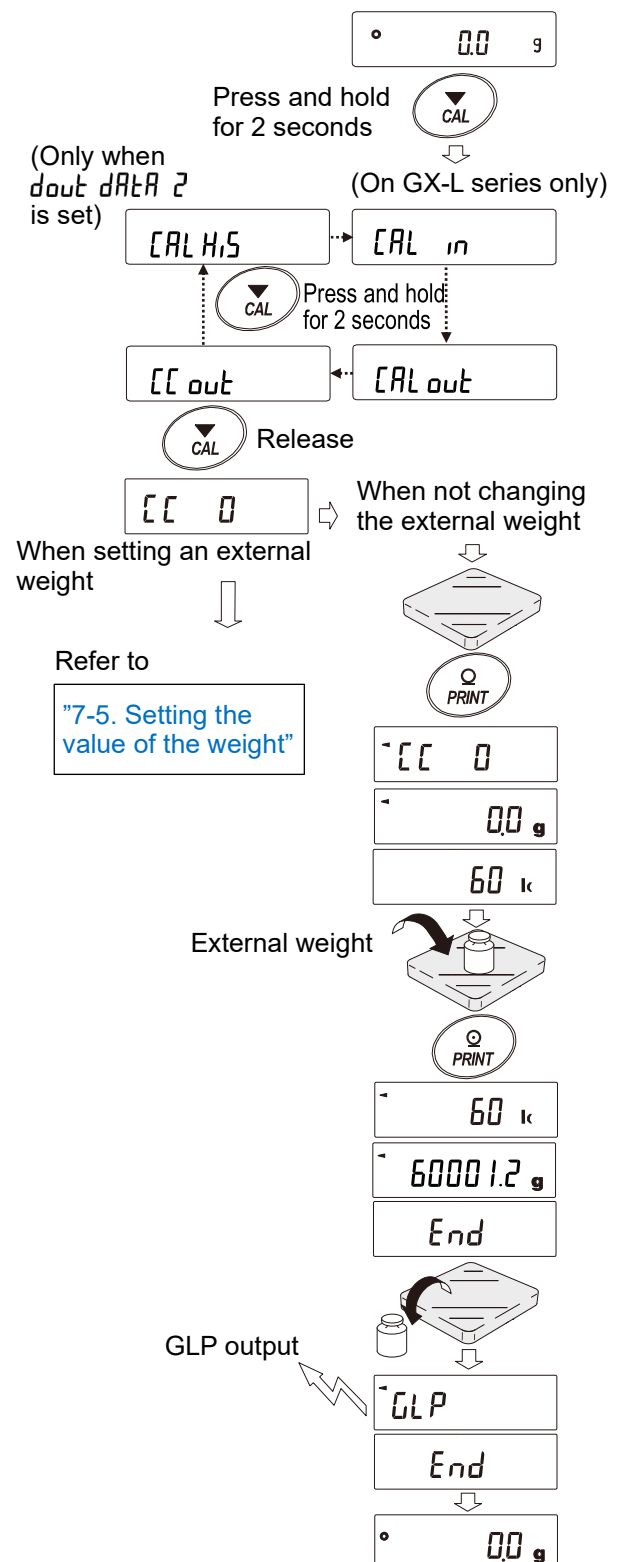

7-5. Setting the value of the weight

For a sensitivity adjustment or calibration test operation, the value of your external weight can be set. (See the usable weight on page 44).

The setting can be made according to the setting procedure after **CAL 0** is displayed in the procedure of “7-3. Sensitivity adjustment using an external weight” or **CC 0** is displayed in the procedure of “7-4. Calibration test using an external weight”.

1. With the **CAL 0** display for sensitivity adjustment or **CC 0** display for calibration test, press the **SAMPLE** key.

2. Using the **ZERO** key, change the value of the external weight to use while all digits are blinking.

3. Set the value of the weight with the following keys.
 - SAMPLE** key Switches the display between "all digits blinking" (weight selection mode) and "last two digits blinking" (instrumental error adjustment mode).

ZERO key Changes weight selection (when all digits blinking) or instrumental error adjustment (when last two digits blinking) (Refer to “Cautions on the use of external weights” in “7. Sensitivity Adjustment / Calibration Test”.)

MODE key In the instrumental error adjustment mode, -50 d appears after +50 d.

PRINT key Stores the changed value. The new value is stored in nonvolatile memory even if the power is removed.

CAL key Suspends the setting.
(The balance returns to the **CAL 0** or **CC 0** display.)

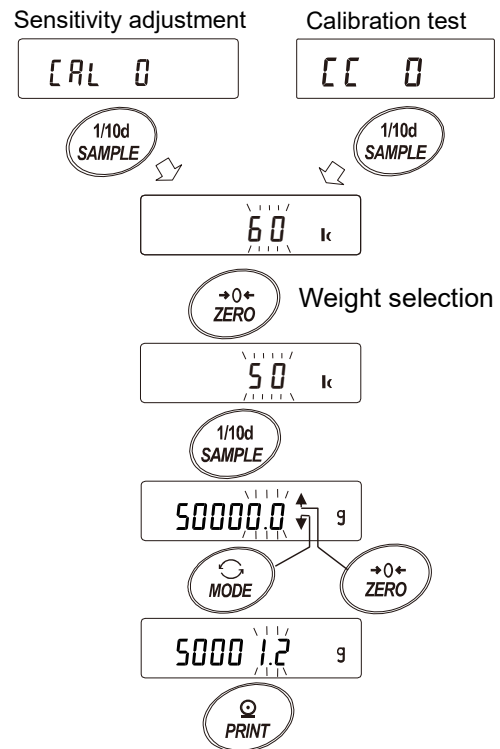

E.g.: Updated weight value
50001.2 g

7-6. Correcting the internal weight value (GX-L series only)

The internal weight value can be corrected when $\boxed{E5 \ 1n}$ is set in the function table.

The following two correction methods are available.

AUTOThe method of internal weight value correction based on external weight using automatic input.

MANUALThe method of internal weight value correction based on external weight using manual input.

Caution

- Correction of the internal weight value cannot be performed at factory setting.
Refer to "8. Function Selection Switch and Initialization" or the following setting procedure to enable changes to the function table and correction of the internal weight value.

Setting procedure

- Press the $\boxed{ON: OFF}$ key to turn the display off.
- While holding down the \boxed{PRINT} and \boxed{SAMPLE} keys, press the $\boxed{ON: OFF}$ key to display $\boxed{P5}$.
- Press the \boxed{PRINT} key. Using the following keys, set the "Internal weight value correction switch" and "Function table switch" to "1".

\boxed{SAMPLE} keySelects the switch (blinking digit).

\boxed{ZERO} keyChanges the value of the blinking switch.

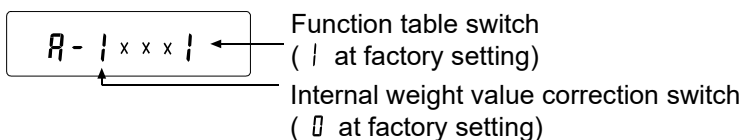

- Press the \boxed{PRINT} key to store the new settings.
The balance returns to weighing mode.

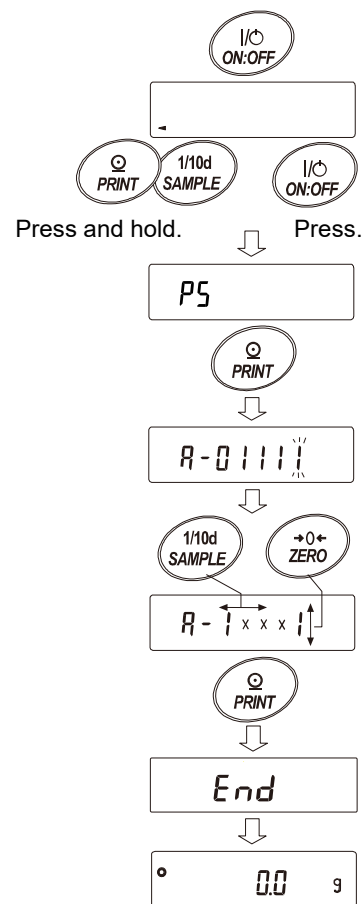

7-6-1. Correcting the internal weight value AUTO (GX-L series only)

This is a method to correct the internal weight value based on your external weight.

First, perform the sensitivity adjustment by referring to “7-3. Sensitivity adjustment using an external weight”.

After the sensitivity adjustment with your external weight, the balance automatically loads and unloads the internal weight and corrects the internal weight value.

Refer to “7. Sensitivity Adjustment / Calibration Test” for usable weights.

The corrected value is stored in nonvolatile memory even if the AC adapter is removed.

Setting procedure

Correction of the internal weight value cannot be performed at factory setting.

Refer to the setting procedure step 1 in “7-6. Correcting the internal weight value (GX-L series only)” and enable changes to the function table and correction of the internal weight value.

1. In weighing mode, press and hold the **SAMPLE** key for 2 seconds to display **bASFnC**.
2. Press the **SAMPLE** key several times until **CS in** appears.
3. Press the **PRINT** key to display **Auto**.
4. Make sure there is no external disturbance, then press the **PRINT** key.
5. **CAL SET** is displayed and correction of the internal weight value starts automatically.
6. When the correction of the internal weight value is completed, **CAL in** is displayed and sensitivity adjustment with the corrected internal weight starts automatically.
7. When the sensitivity adjustment is completed, **Auto** is displayed. Press the **CAL** key twice to return to weighing mode.
8. Place the weight used for correction to confirm that the internal weight value is correctly adjusted. If it is not correctly adjusted, try again from the first step. (Make sure there is no external disturbance during correction of the internal weight value.)

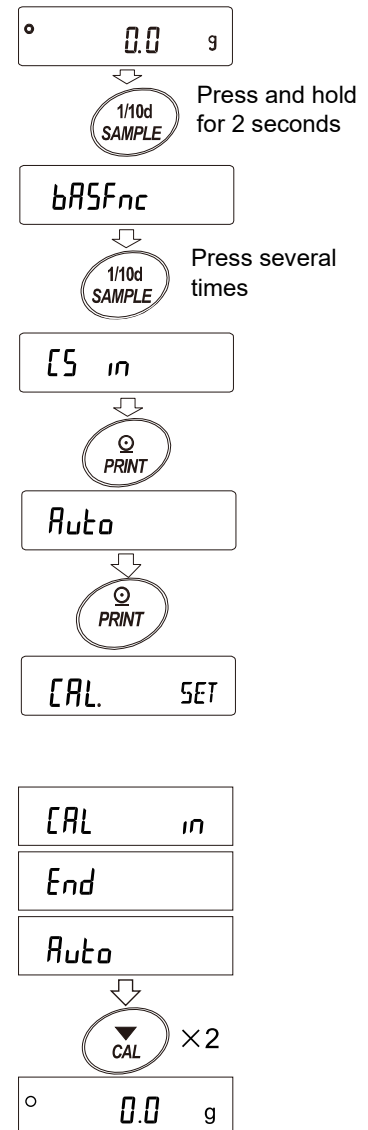

7-6-2. Correcting the internal weight value MANUAL (GX-L series only)

The GX-L series balance can correct the internal weight value within a certain range to conform to your external weight. The table below shows the correction reference values and correction ranges. The corrected value is maintained in non-volatile memory even if the AC adapter is removed.

Series	Correction reference value	Correction range
GX-12001L	10 kg	±5.0 g
GX-22001L	20 kg	±5.0 g
GX-32001L GX-32001LS	20 kg	±5.0 g
GX-32001LD GX-32001LDS	20 kg	±5.0 g
GX-62001L GX-62001LS	20 kg	±5.0 g
GX-42001L	40 kg	±5.0 g
GX-62000L GX-62000LS	60 kg	±50 g
GX-102000L GX-102000LS	100 kg	±50 g

(Continue to “E.g. GX-22001L” on the next page.)

E.g. GX-22001L

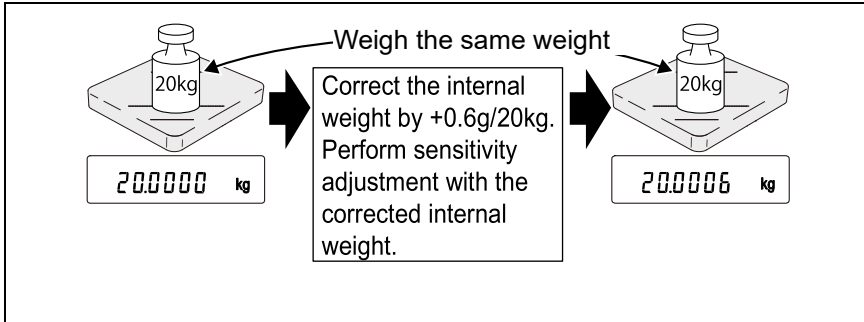

Setting procedure

Correction of the internal weight value cannot be performed at factory setting. Refer to the setting procedure Step 1 in “7-6. Correcting the internal weight value (GX-L series only)” and enable changes to the function table and correction of the internal weight value.

1. Perform sensitivity adjustment of the balance. Then, place an external weight and confirm the value to be corrected. (In the example, the value is to be corrected by +0.6 grams in 20 kilograms.)
2. Press and hold the **[SAMPLE]** key to display **bRSFnC** (to enter the function table).
3. Press the **[SAMPLE]** key several times until **[5 in** is displayed.
4. Press the **[PRINT]** key to display **Auto**.
5. Press the **[SAMPLE]** key to display **MANUAL**, and then press the **[PRINT]** key.
6. Select with the following keys.
 - [ZERO]** key Select the value to be corrected.
(-50 d appears after +50 d.)
 - [PRINT]** key Stores the value. The next item appears.
 - [CAL]** key Suspends the setting. The next item appears.
7. Press the **[CAL]** key to return to weighing mode.
8. Press the **[CAL]** key to perform sensitivity adjustment with the internal weight.
9. Place the external weight on the weighing pan and confirm that the correction has been performed properly. (In this example, confirm that the value displayed is within ± 2 d of the correction reference value for 20 kilograms.) If the value is not within ± 2 d of the correction reference value, repeat the above procedure to correct it.

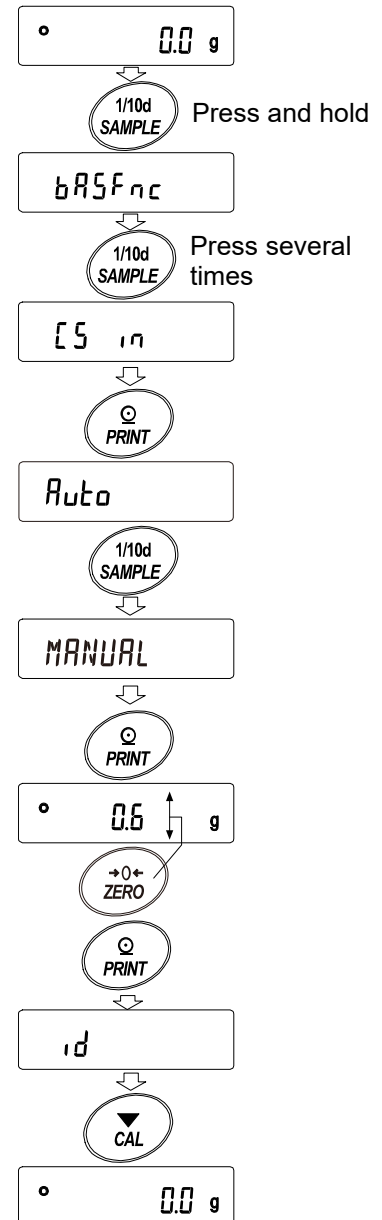

8. Function Selection Switch and Initialization

8-1. Function selection switch

The balance stores data that must not be changed unintentionally (such as adjustment data for accurate weighing, data for adapting to the usage environment, data to control the communications interface, etc.). In order to protect such data, "Function selection switch" is provided and either "prohibit changes " or "allow changes/use" can be selected. When "prohibit changes" is set, inadvertent data change can be prevented because the function cannot be activated.

There are five types of "Function selection switch":

- Function table
- Sensitivity adjustment using the internal weight
- Sensitivity adjustment using an external weight
- Automatic sensitivity adjustment
- Internal weight correction

Setting procedure

1. Turn off the display.
2. Press and hold the **PRINT** key and the **SAMPLE** key, press the **ON:OFF** key to display **P5**.
3. Press the **PRINT** key, and then use the following keys to set the function selection switch.
 - SAMPLE** key Selects the switch (blinking digit) to change.
 - ZERO** key Changes the value of the blinking switch.
 - 0 Prohibit changes / use
 - 1 Allow changes / use
 - PRINT** key Stores the new value. The balance returns to weighing mode.
 - CAL** key Cancels the operation (**Err** appears)
 - To return to weighing mode, press the **CAL** key again.

E.g. Function selection switches of GX-L series (display at factory setting)

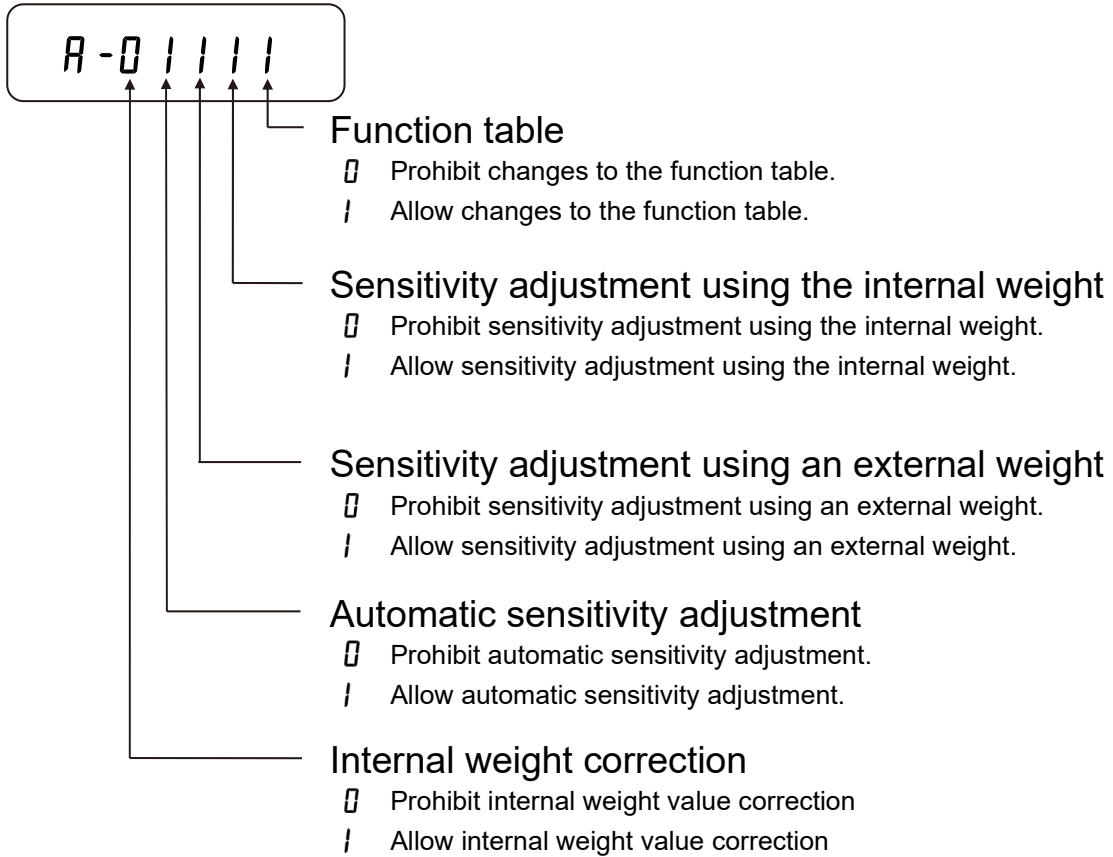

E.g.: Function selection switches of GF-L series (display at factory setting)

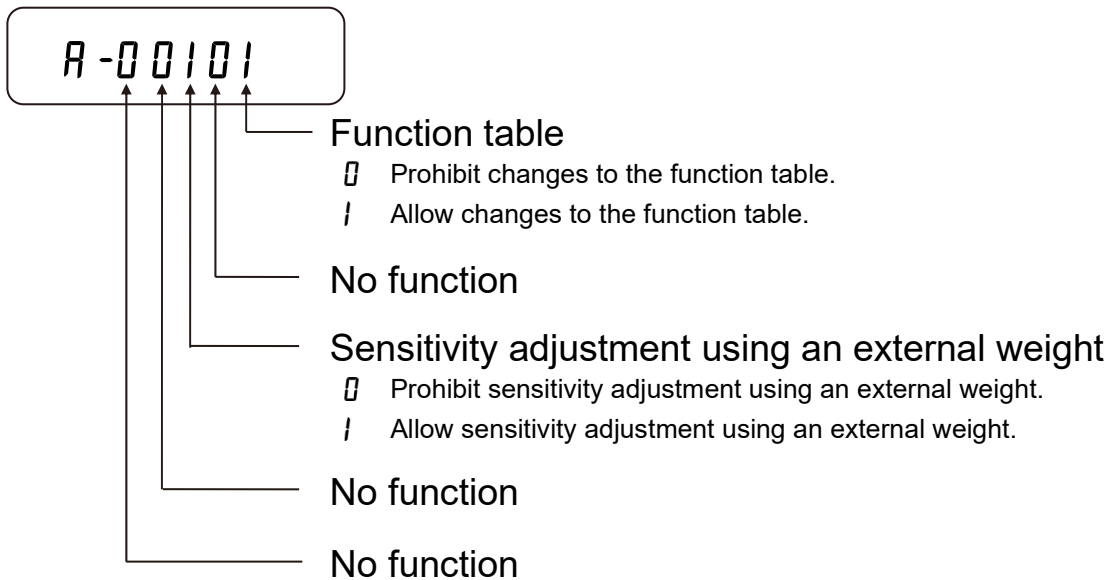

8-2. Initializing the balance

This function returns the parameters of the balance to factory settings.

8-2-1. Initialization (all items)

This function resets the following parameters to factory settings.

- Sensitivity adjustment data
- Function table, unit weight value (counting mode), 100% reference mass value (percent mode)
- External weight value
- Function switch settings
- Statistical calculation data
- Internal weight value (GX-L series only)

Caution

- After initializing the balance, be sure to perform sensitivity adjustment.

Setting procedure

4. Press the **ON:OFF** key to turn off the display.
5. While holding down the **PRINT** and **SAMPLE** keys, press the **ON:OFF** key to display **PS**.
6. Press the **SAMPLE** key to display **CLr ALL**.
7. Press the **PRINT** key.
(To cancel, press the **CAL** key.)
8. Use the **ZERO** key to switch between $N_0 / 50$.
9. With **CLr ALL 50** displayed, pressing the **PRINT** key performs initialization.
10. When initialization is completed, the balance automatically returns to weighing mode.

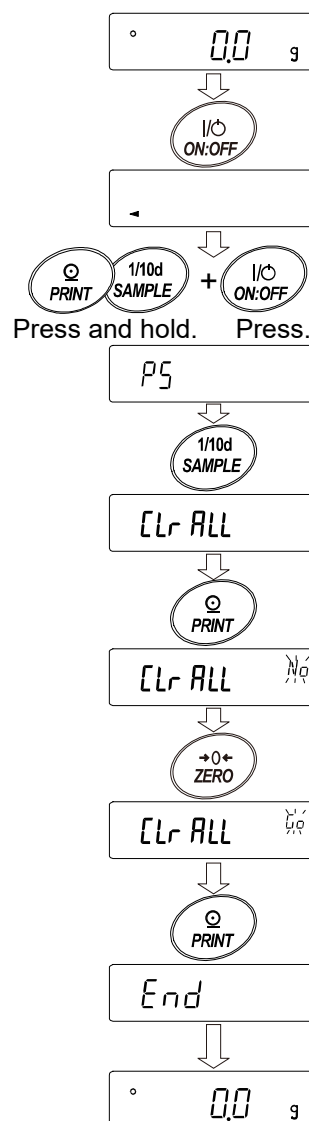

8-2-2. Initialization (function table only)

This function returns the following parameters to factory settings.

□ Function table

1. Press the **ON:OFF** key to turn the display off.
2. While pressing the **PRINT** and **SAMPLE** keys, press the **ON:OFF** to display **P5**.
3. Press the **SAMPLE** key twice to display **Clr Fnc**.
4. Press the **PRINT** key.
(To cancel, press the **CAL** key.)
5. Use the **ZERO** key to switch between "No / Go".
6. With **Clr Fnc Go** displayed, pressing the **PRINT** key performs initialization.
7. When initialization is completed, the balance automatically returns to weighing mode.

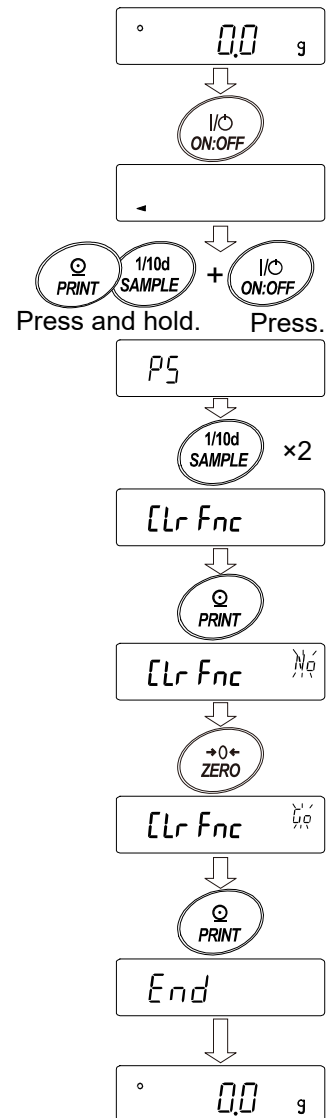







9. Function Table

The function table enables you to change operation of the balance to the settings suitable for your application. Set parameters are stored in nonvolatile memory, even if the AC adapter is removed, and they are valid until rewritten. The function table consists of two layers. The first layer is the classes and the second layer is the items. Each item stores a parameter.

9-1. Setting the function table

Display and key operation for the function table

	The "○" indicator shows that the parameter is currently enabled.
	Holding down this key (for 2 seconds) in weighing mode activates function table mode. (The class menu is displayed.) Selects the class / item.
	Changes the parameter.
	Selects the class or item.
	Moves from the class to the item. Stores the parameter and moves to the next class.
	When an item is displayed, quits setting and moves to the next class. When a class is displayed, exits table function mode and returns to weighing mode.

Setting procedure



- In weighing mode, press and hold the **SAMPLE** key for 2 seconds to display **bH5FnC**.
- Press the **SAMPLE** key to select a class.
- Press the **PRINT** key to enter the class setting mode.
- Press the **SAMPLE** key to select an item.
- Press the **ZERO** key to change the parameter of the selected item.
- To change other item(s) in the same class, repeat steps 4 and 5.
To finish setting for the class, proceed to step 7.
- To store the settings for the class, press the **PRINT** key to display the next class.
To quit setting for the class, press the **CAL** key to display the next class.
- To change the settings in another class, proceed to step 2.
To exit function table mode, press the **CAL** key once. The balance returns to weighing mode.

Setting example and menu structure

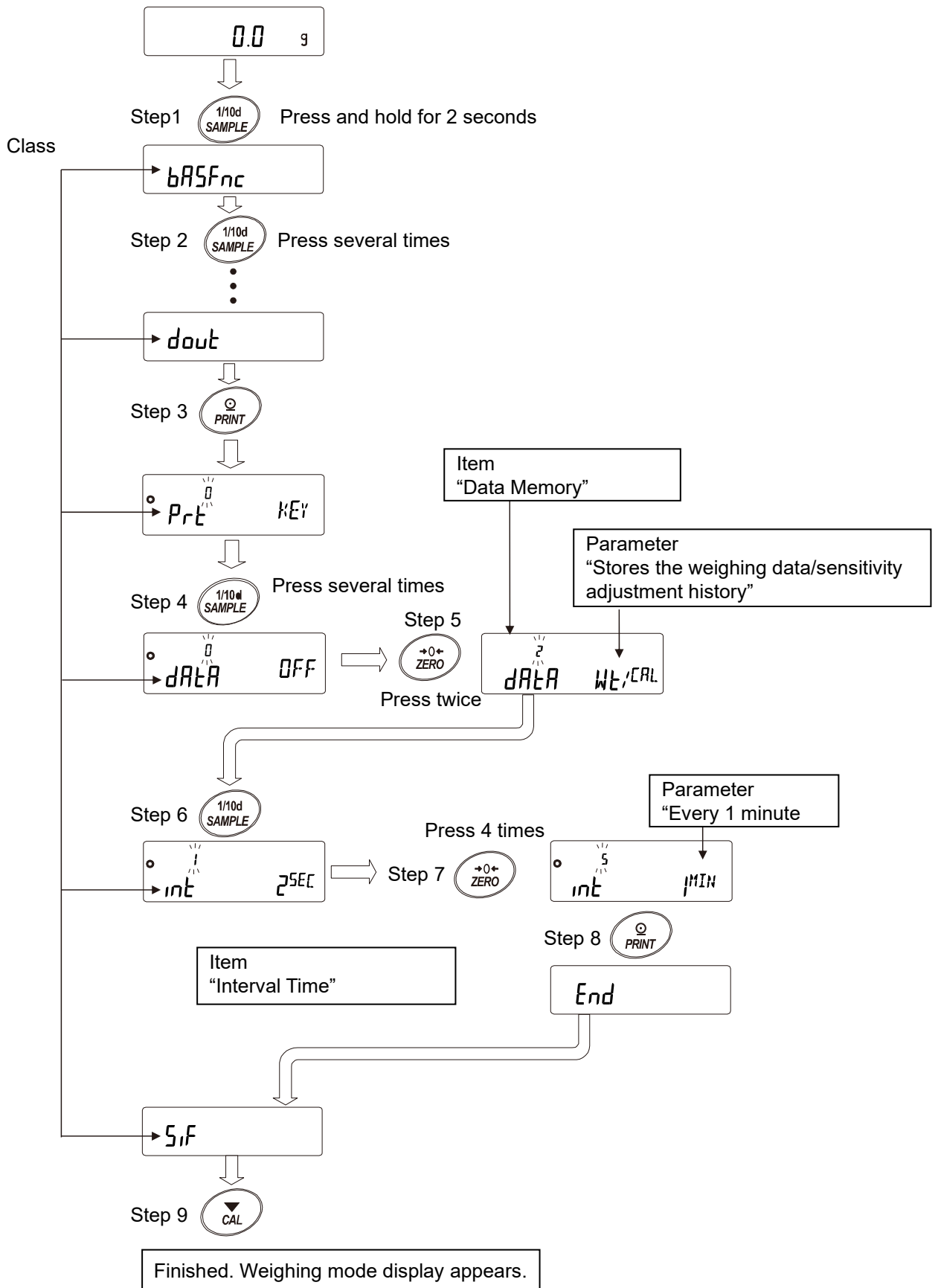
This example shows how to set "Stores the weighing data/sensitivity adjustment history (dAtA 2)" for "Data Memory (dAtA)" and "Every 1 minute (int 5)" for "Interval Time (int)".



9-2. Details of the function table

Class	Item	Parameter	Description		
bRSFnC [00] Environment Display	Cond Condition	0	Fast response, sensitive value		
		■ 1			
		2			Slow response, stable value
	St-b Stability band width	0	Stricter judgment (± 1 d)		
		■ 1			
		2			Less strict judgement (± 3 d)
	Hold Hold Function	■ 0	Off	Mode A: For animal weighing. Holds the display for five seconds after the sample is removed. Mode B: Holds the display for five seconds when stable after the sample is removed.	
		1	A		
		2	B		
	trc Zero Tracking	0	Off	Keeps zero display by tracking zero drift.	
		■ 1	Normal		
		2	Slightly strong		
		3	Strong		
	SPd Display refresh rate	■ 0	Approx. 5 times/second (5.2 Hz)	Display/output frequency	
		1	Approx. 10 times/second (10.4 Hz)		
		2	Approx. 20 times/second (20.8 Hz)		
	Pnt Decimal separator	■ 0	Point (.)	Sets the symbol used as a decimal separator for display and output	
		1	Comma (,)		
	P-on Auto display-ON	■ 0	Off	Turns on the weighing mode display when the AC adapter is connected.	
		1	On		
P-off Auto display-OFF	■ 0	Off	Turns off the display after 10 minutes of inactivity.		
	1	On (10 minutes)			
rnG Readability	■ 0	Display with readability digit	Display at start of weighing.		
	1	Display without readability digit			
bEEP Buzzer	0	Off	The buzzer sounds when you operate the keys and the like.		
	■ 1	On			
P-1Er0 Display when power-on	■ 0	Display zero when power is turned on			
	1	Display last weighing value when power is turned on			

■ Factory setting

"d" (readability digit) is the unit of readability. For example, if the readability is 0.1 g, 1 d is 0.1 g.

Note

- The number in [] is the classification number. It is output as an identifier when outputting function table information in batch. Refer to "9-2-1. Output of the function table information".

Class	Item	Parameter	Description		
bRSFnC [00] Environment Display (Continued from previous page)	d,SP-LEd Backlight brightness	0-9	10% to 100%		
		■ 5	60% at factory setting		
	LV-LEd Bubble spirit level lighting	0	Off		
		■ 1	On		
	,Sd Impact shock detection	0	Off		
		■ 1	On		
	LV-]tc Level detection	0	Off		
		■ 1	On		
[L Add [01] Clock	Refer to "9-4. Clock and calendar function".		Confirms and sets the time and date. The time and date are added to output data.		
[P FnC [02] Comparator	[P Comparator mode	■ 0	No comparison (Comparator function is disabled.)		
		1	Comparison when stable value or overloaded.		
		2	Continuous comparison		
	[P-t Number of comparator stages	■ 0	3-stage comparator	HI, OK, LO	
		1	5-stage comparator	HH, HI, OK, LO, LL	
	[P-z Near zero	0	Comparison including near zero		
		1	Comparison excluding ± 5 d		
		■ 2	Comparison excluding ± 10 d		
		3	Comparison excluding ± 20 d		
		4	Comparison excluding ± 50 d		
		5	Comparison excluding ± 100 d		
	[P-P Polarity	0	Positive only		
		1	Negative only		
		■ 2	Bi-polar		
	[P-R Comparator results	■ 0	Off	Comparator results can be added to output data. Use this mode with A&D standard format (S,F TYPE 0)	
		1	On		
	[P-in Input method	■ 0	Sets upper and lower limits. Digital input	[P HH, [P Hi, [P Lo, or [P LL can be selected.	
		1	Sets upper and lower limits. Input by load		
		2	Sets reference value. Digital input		
		3	Sets reference value. Input by load		
	[P-Frd Flow measurement	■ 0	Compare by flow rate value.		
		1	Compare by weighing value (g unit).		
	[P-b Comparator enlarged display	■ 0	Off	Displays LO/OK/HI enlarged on the weighing value display when the comparator is used.	
		1	On		

■ Factory setting

"d" (readability digit) is the unit of readability. For example, if the readability is 0.1 g, 1 d is 0.1 g.

Class	Item	Parameter	Description	
[P VALUE] [03] Comparator value	[P HH Second upper limit	Refer to "9-5. Comparator function".	Displays when [P in 0/ 1] is selected. Displays [P HH / [P LL] only when the 5- stage comparator is set.	
	[P H1 Upper limit			
	[P L0 Lower limit			
	[P LL Second lower limit			
	[P rEF Reference value	Refer to "9-5. Comparator function".	Displays when [P in 2 / 3] is selected. Displays [P LME2] only when the 5-stage comparator is set.	
	[P LME Tolerance value			
	[P LME2 Second tolerance value			
[P BEEP] [04] Comparator buzzer	bEP HH HH buzzer	■ 0	Off	Displays only when the 5-stage comparator is set.
			On	
	bEP H1 H1 buzzer	■ 0	Off	
			On	
	bEP ok OK buzzer	■ 0	Off	
			On	
	bEP L0 LO buzzer	■ 0	Off	
			On	
	bEP LL LL buzzer	■ 0	Off	Displays only when the 5-stage comparator is set.
			On	

■ Factory setting

Class	Item	Parameter	Description
<i>dout</i> [05] Data output	<i>Prt</i> Data output mode	0	Key mode Outputs data accepting the <input type="text" value="PRINT"/> key when the display is stabilized.
		1	Auto print mode A (Reference = zero) Outputs data when the weighing value is stable beyond the range of $RP-P$ and $RP-b$ from the zero point.
		2	Auto print mode B (Reference = the latest stable value) Outputs data when the weighing value is stable beyond the range of $RP-P$ and $RP-b$ from the latest stable value.
		3	Stream mode Outputs data at the specified display refresh rate.
		4	Key mode B (Immediate output) Outputs data accepting the <input type="text" value="PRINT"/> key regardless of whether or not the weighing value is stable.
		5	Key mode C (Output when stable) Immediately outputs data accepting the <input type="text" value="PRINT"/> key when the weighing value is stable. When unstable, outputs data after the weighing value becomes stable.
		6	Interval output mode Outputs data periodically as set for <input type="text" value="int"/> .
		7	Auto print mode C (When the comparator result is OK.) Outputs data when the weighing value is stable beyond the range of $RP-P$ and $RP-b$ from zero point and the weighing value is stable with an OK result.

■ Factory setting

Class	Item	Parameter	Description	
<i>dout</i> [05] Data output (Continued from previous page)	<i>RP-P</i> Auto print polarity	■ 0	Positive only	If greater than the reference.
		1	Negative only	If less than the reference.
		2	Bi-polar	Regardless of whether greater or less than the reference.
	<i>RP-b</i> Auto print band width)	■ 0	10 d	Select difference from the reference.
		1	100 d	
		2	1000 d	
	<i>dRRR</i> Data memory	■ 0	Off	Refer to “11. Data Memory”.
		1	Stores the unit weight	
		2	Stores the weighing data / sensitivity adjustment report	
		3	Stores the comparator setting value	
		4	Stores the tare value	

■ Factory setting

"d" (readability digit) is the unit of readability. For example, if the readability is 0.1 g, 1 d is 0.1 g.

Class	Item	Parameter	Description		
<i>dout</i> [05] Data output (Continued from the previous page)	<i>int</i> Interval time	0		At the specified display refresh rate	Used when "interval output mode (<i>Prt 5</i>) is set in "data output mode".
		■ 1		Every 2 seconds	
		2		Every 5 seconds	
		3		Every 10 seconds	
		4		Every 30 seconds	
		5		Every 1 minute	
		6		Every 2 minutes	
		7		Every 5 minutes	
		8		Every 10 minutes	
	<i>5-tA</i> Tare value output	■ 0		No output	Outputs in the order of net weight, gross weight, and tare weight.
		1		Output	
	<i>d-no</i> Data No. output	■ 0		No output	Available when the data memory function is enabled.
		1		Output	
	<i>5-td</i> Time/date output	■ 0		No output	For setting the time/date to be output, refer to "9-4. Clock and calendar function".
		1		Time output only	
		2		Date output only	
		3		Time and date output	
	<i>5-id</i> ID output	■ 0		No output	
		1		Output	
	<i>PUSE</i> Data output pause	■ 0		Off	Sets a pause until data output.
		1		On Adds 1.6 seconds	
	<i>Alt-F</i> Auto feed	■ 0		Off	Sets a line feed after data output.
		1		On Adds one line	
	<i>info</i> GLP output	■ 0		Off	Refer to "10-3. GLP report".
		1		On (Outputs with the internal clock)	
		2		On (Outputs with an external clock)	
<i>Ar-d</i> Auto zero after data output	■ 0		Off	Function to automatically set to zero after data output.	
	1		On		
<i>UFC</i> Universal Flex Coms	■ 0		Off		
	1		On		

■ Factory setting

Class	Item	Parameter	Description		
SIF [06] Serial Interface	MODE Connection	■ 0	PC		
		1	Printer	TYPE 0, 1	
		2	External indicator	Stream output with TYPE 0.	
	bPS Baud rate	0	600 bps		
		1	1200 bps		
		■ 2	2400 bps		
		3	4800 bps		
		4	9600 bps		
		5	19200 bps		
		6	38400 bps		
	bPr Data bit, Parity bit	■ 0	7 bits, even		
		1	7 bits, odd		
		2	8 bits, none		
	CrLF Carriage return, Line feed	■ 0	CRLF	CR: ASCII 0Dh code	
		1	CR	LF: ASCII 0Ah code	
	TYPE Data format	■ 0	A&D standard format		Refer to “9-7. Weighing data format”.
		1	DP format		
		2	KF format		
		3	MT format		
		4	NU format		
		5	CSV format		
		6	NU2 format		
	t-UP Timeout	0	No limit		The wait time to receive a command.
■ 1		Limits to one second			
ErCd AK, Error code	■ 0	Off		AK: ASCII 06h code	
	1	On			

■ Factory setting

Class	Item	Parameter	Description		
U5b [07] USB interface	UFnc USB Function mode	■ 0	Quick USB		
		1	Bidirectional USB virtual COM		
	U-tP USB data format	■ 0	A&D standard format		
		1	NU format		
		2	CSV format		
		3	TAB format		
4	NU2 format				
AP Fnc [10] Application Function	APF Application mode	■ 0	Normal weighing mode		
		1	Capacity indicator mode		
		2	Statistical calculation mode		
		3	Flow rate measurement mode		
	StAF Statistical function mode output items	■ 0	Number of data, sum		
		1	Number of data, sum, max, min, range (max-min), average		
		2	Number of data, sum, max, min, range (max-min), average, standard deviation, coefficient of variation		
		3	Number of data, sum, max, min, range (max-min), average, standard deviation, coefficient of variation, relative error		
	Frd Unit Flow rate unit	■ 0	g/s (gram/second)		Refer to "13. Flow Rate Measurement".
		1	g/m (gram/minute)		
		2	g/h (gram/hour)		
		3	mL/s (milliliter/second)		
		4	mL/m (milliliter/minute)		
		5	mL/h (milliliter/hour)		
Et AUto Calculation time automatic setting	■ 0	Off			
	1	On			
MW Fnc [11] Minimum Weight alert function	MW-CP Minimum weight comparison	■ 0	No comparison. The minimum weight alert function is disabled.		
		1	Comparison excluding near zero		
		2	Comparison including near zero		
	MW Minimum weight input	Refer to "14. Minimum Weight Alert Function".			
Min out Data output when minimum weight is not reached.	0	Off		Refer to "14. Minimum Weight Alert Function".	
	■ 1	On			

■ Factory setting

Class	Item	Parameter	Description	
<i>Unit</i> [12] Unit			Refer to “9-9. Storing units”.	
<i>dS Fnc</i> [13] Density measurement function	<i>Ld in</i> Liquid density input	■ 0	Water temperature	Displayed only when density mode is registered in unit registration. Refer to “15. Density (Specific Gravity) Measurement”.
			Density input	
	<i>dS</i> Density measurement mode	■ 0	Solids	
			Liquids	
<i>id</i> [15] ID number setting			Refer to “10-2. Setting the ID number”.	
<i>PASSwd</i> [16] Password lock	<i>Lock</i> Lock function	■ 0	Off	Refer to “16. Password Lock Function”.
			On (Restricts weighing operation)	
		2	On (Allows basic weighing operation)	
	<i>PASS No.</i> Password registration	<i>ADMIN</i>	Administrator password input	
		<i>USER 01</i> to <i>USER 10</i>	User 1 password input User 10 password input	
<i>Auto CAL</i> [17] Auto sensitivity adjustment	<i>CFnc</i> Sensitivity adjustment mode	■ 0	Temperature measurement	Refer to “7-1. Automatic sensitivity adjustment (GX-L series only)”.
			Set time	
		2	Interval time	
	<i>ETME1</i> Set time 1			
	<i>ETME2</i> Set time 2			
	<i>ETME3</i> Set time 3			
	<i>Int</i> Interval time			
<i>IS in</i> [18] *2 Correction of the internal weight value	<i>Auto</i> (Auto)	Automatic input	Refer to “7-6-1. Correcting the internal weight value AUTO (GX-L series only)”.	

■ Factory setting

*2: GX-L series only.

9-2-1. Output of the function table information

With the function table, you can set the balance's operation to that appropriate for how it is used.

In the menu structure of the function table, setting items are included in each class, and a parameter is registered for each item. The function table information can be output in batch by the following operation so that the settings when the balance is used can be recorded.

Procedure for batch output of the function table information

1. Press and hold the **SAMPLE** key for 2 seconds in weighing mode to display **bASFnC**.
2. Press and hold the **PRINT** key for 2 seconds. **-L,5t-** appears and the current function table information is output in batch.

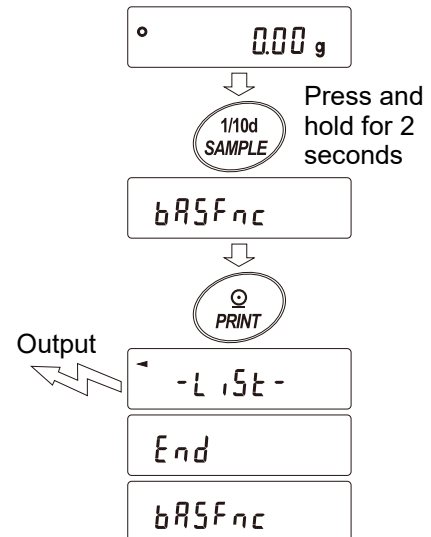

[Output example]

A & D		
MODEL	GX-62001L	Model
S/N	T3000131	Serial number
ID	00LAB-0123000	ID
DATE	2023/06/01	Date
TIME	08:52:45	Time

Function Table		
:00:	Cond	:01:
:00:	St-b	:01:
:00:	HoLd	:00:
:00:	trc	:01:
:00:	SPd	:00:
:00:	Pnt	:00:
:00:	P-on	:00:
:00:	P-off	:00:
:00:	rnG	:00:
:00:	bEEP	:01:
:00:	P-Zero	:00:
:00:	diSP-LEd	:05:
:00:	LV-LEd	:01:
:00:	iSd	:01:
:00:	LV-CHK	:01:

(a)	(b)	(c)
:	:	:
:	:	:
10,	APF	:00
10,	StAF	:00
10,	Frd Unit	:00
10,	Ct AUto	:00

11,	MW-CP	:00
11,	MW	:+000000.0 g
11,	Min out	:01

16,	LocK	:00

17,	CFnc	:00
17,	Cint	:00

END		

(a) Class number (two characters)
 (b) Item (eight characters)
 (c) Parameter (two or twelve characters)
 * Separated by commas.

{ Clock of the balance
 Date
 Time

For the class numbers, items, and parameters, refer to “9-2. Details of the function table” in “9. Function Table”.

Example 1 Outputting the function table information to a printer

Use an AD-8127 multi-functional compact printer.

1. Connect the balance and the printer.

Set the print mode to "DUMP".

For details about the settings and print modes, refer to the instruction manual of the printer.

For connection between the balance and the printer, refer to "21. Connecting Peripheral Devices".

2. Make sure that communication is possible between the balance and the printer, then perform the output operation according to "Procedure for batch output of the function table information" in "9-2-1. Output of the function table information".

Example 2 Outputting the function table information to a personal computer

For USB settings and details of the WinCT software, refer to "21-5. Connecting to a PC" in "21. Connecting Peripheral Devices", or the WinCT manuals on our website (<https://www.aandd.jp>).

1. Connect the balance and the PC with the supplied USB cable or RS-232C cable (sold separately)

Note To output via USB, Virtual COM mode must be used. It is not possible to output with Quick USB mode.

2. Install WinCT software on the PC.

WinCT can be downloaded from our website (<https://www.aandd.jp>).

3. Start RSCom and match the communication settings such as COM port and baud rate with the balance. Clicking the [Start] button enables communication.

4. Make sure that communication is possible between the balance and the PC, then perform the output operation according to "Procedure for batch output of the function table information" in "9-2-1. Output of the function table information".

9-3. Description of the class “Environment/Display”

Condition (Cond)

$\text{Cond } 0$



$\text{Cond } 2$

Sensitive response to fluctuation of a weighing value:

For powder or liquid target weighing, weighing a very light sample, or when work efficiency is required rather than display stability, set the parameter to be a small value. When set, FAST is displayed.

Slow response to fluctuation of a weighing value:

To prevent the weighing value from drifting due to vibration or drafts, set the parameter to be a high value. When set, SLOW is displayed.

Stability band width (St-b)

This item is to control the width to regard a weighing value as a stable value. When the fluctuation range of weighing value within a certain period of time is less than the parameter, the balance displays the stabilization indicator and the data can be output (or stored) as set in the function table (dout , dAtA , etc.). This setting influences "auto print mode". "d" (readability digit) is the unit of readability.

E.g. For the GX-62001L, if 1 g display is selected with the SAMPLE key, 1 g is 1 d.

$\text{St-b } 0 (\pm 1 \text{ d})$



$\text{St-b } 2 (\pm 3 \text{ d})$

The stabilization indicator will not display if the value is not stable enough, and it will disappear if there are even slight fluctuations in the weighing value. To perform weighing with strict judgment, set the parameter to a low value.

The stabilization indicator becomes less responsive to slight fluctuations in the weighing value. To prevent the weighing value from drifting due to factors such as the usage environment, set the parameter to a high value.

Hold function (Hold)

Mode A (Average hold, animal weighing)

This function is used to weigh a moving object such as an animal. When the weighing data is over the weighing range from zero and the display fluctuation is within the stabilization range for a fixed period of averaging time, the processing indicator illuminates and the balance displays the average weight of the weighing data. When the animal or sample is removed from the weighing pan, the display holds the displayed value for five seconds and then returns to zero automatically. This function is available only when the hold function parameter is set to "1" (the display hold mark HOLD illuminates) and any weighing unit other than the counting mode is selected. The stabilization range and averaging time are set in "Condition (Cond)" and "Stability band width (St-b)" in the function table.

Weighing range		Averaging time		Stabilization range		
0.1 g model	20.0 g or more	$\text{Cond } 0$	2 sec. (faster)	$\text{St-b } 0$	Small	6.25%
1 g model	200 g or more	$\text{Cond } 1$	4 sec.	$\text{St-b } 1$	Medium	12.5%
		$\text{Cond } 2$	8 sec. (more accurate)	$\text{St-b } 2$	Large	16.7%

* Animal weighing pan (GXL-12) can be attached.

B mode (hold when stable)

When the weighing value is beyond a certain range from zero (same weighing range as mode A) and the stabilization indicator lights up, the displayed value is held. When the object to be weighed is unloaded, the display is automatically set to zero after the display is maintained for 5 seconds. This function is available when the balance is in other than counting mode.

Zero tracking (t_{rc})

This function automatically tracks zero-point drift caused by changes in the environment and stabilizes the zero display. When the weighing value is only a few digits, turn the function off for accurate weighing.

"d" (readability digit) is the unit of readability.

$t_{rc} \ 0$ The tracking function is not used. When the weighing value is only a few digits, turn the function off for accurate weighing.

$t_{rc} \ 1$ The tracking function is used. Normal zero tracking. ($\pm 1 \text{ d} / 1 \text{ second}$)

$t_{rc} \ 2$ The tracking function is used. Strong zero tracking. ($\pm 1 \text{ d} / 0.5 \text{ seconds}$)

$t_{rc} \ 3$ The tracking function is used. Very strong zero tracking. ($\pm 1 \text{ d} / 0.2 \text{ seconds}$)

Display refresh rate ($5P_d$)

The periodic time to refresh the display. This timing also applies to data output.

This parameter influences "baud rate", "data output pause" and the operation in the stream mode.

Decimal separator (P_{nt})

A symbol used as a decimal separator (point/comma) can be selected.

Auto power-ON (P_{on})

When the AC adapter is plugged in, the display is automatically turned on without pressing the ON:OFF key and the balance enters weighing mode. This function is used when the balance is built into an automated system. Be sure to warm up the balance before use for more than half an hour for accurate weighing.

Auto power-OFF (P_{off})

This is a function to automatically turn off only the display when there is no operation made for a certain amount of time (approx. 10 minutes) while the power is on.

Readability (r_{nL})

When weighing with rough precision, the readability can be turned off without key operation. This is useful when built into an automated system.

Buzzer ($bEEP$)

Select ON / OFF for the built-in buzzer that sounds when a key is operated or the state changes.

Display when power-on (P-ZERO)

You can choose whether the balance will automatically zero the display when the power is turned on or start from the previous weighing value without automatically zeroing the display when the power is turned on. The tare value memory is useful when a hopper or other device is attached to the weighing pan and the power must be turned off during discharge weighing. Note that this function is disabled when the hold function is on.

Backlight brightness (d,SP-LED)

Select the brightness of the backlight of the LCD display.

Bubble sprit level lighting (LV-LED)

Select ON / OFF for the LED that illuminates the bubble sprit level.

Impact shock detection (,5d)

Select ON / OFF for the function to display impact level.

Automatic level detection & warning (LV-TILT)

This is a function that displays by the level detection sensor when the balance is significantly tilted, prompting the user to adjust the level of the balance. Note that is displayed only when the display is zero.

9-4. Clock and calendar function

The balance is equipped with a clock and calendar function. When the clock and calendar function (*dout*, 5-Ed) is set, the time/date can be added to the output data. The time and date can be checked/changed by the following operations.

Checking/setting procedure

- In weighing mode, press and hold the **SAMPLE** key for 2 seconds to display **bRSFnC**.
- Press the **SAMPLE** key several times to display **CL Adj**.
Press the **PRINT** key to enter the mode to check and set the time and date.

Checking the time

- The current time is displayed with all the digits blinking.
 - To set the clock to the correct time, press the **ZERO** key and proceed to step 5.
 - To check the date, press the **SAMPLE** key and proceed to step 6.
 - To finish setting, press the **CAL** key and proceed to step 8.

Setting the time

Set the time in 24-hour format using the following keys.

ZERO key (+) Increases the value of the blinking digit.

MODE key (-) Decreases the value of the blinking digit.

SAMPLE key Select the digit to blink.

PRINT key Stores the setting and proceeds to step 6 after **End** is displayed.

CAL key Cancels the setting and proceeds to step 6.

Checking the date

- The current date is displayed with all the digits blinking.
 - To change the order of year [last two digits] (*y*), month (*n*) and day (*d*), press the **MODE** key. The date will be output in the specified order.
 - To set the calendar to the correct date, press the **ZERO** key to proceed to step 7.
To finish setting, press the **CAL** key to proceed to step 8.
To confirm the time again, press the **SAMPLE** key to proceed to step 4.

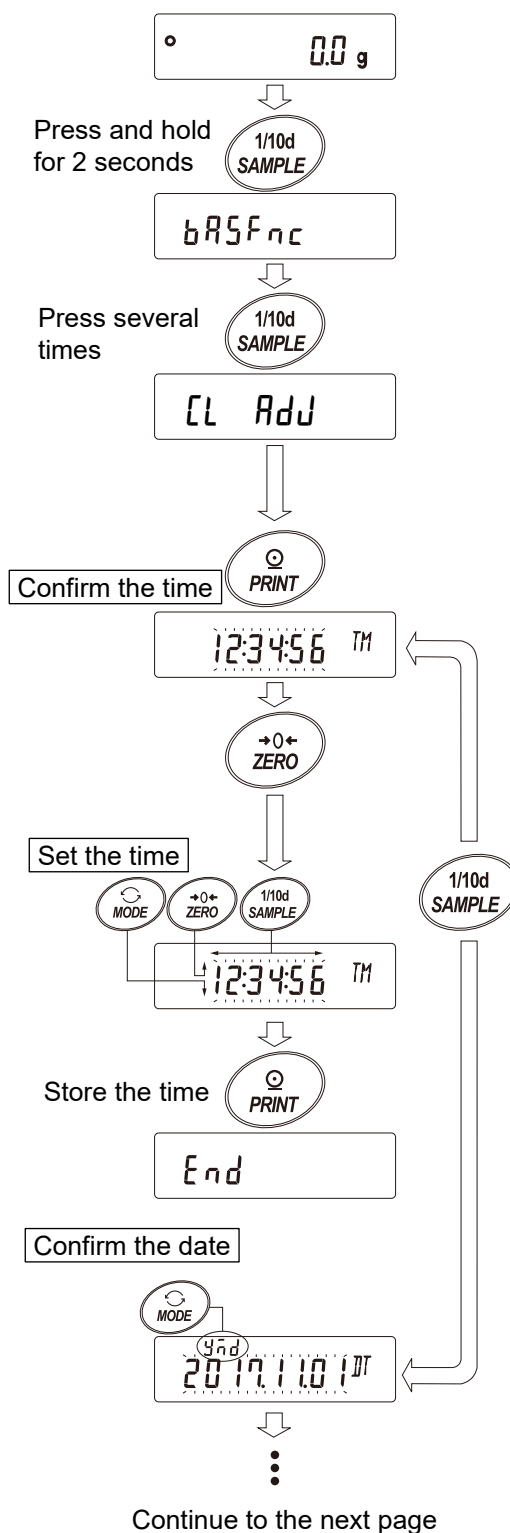

Checking/setting procedure (Continued)

Setting the date

Set the date using the following keys. (The year is set with the last 2 digits of the year as per Western calendar)

ZERO key (+) Increases the value of the blinking digit.

MODE key (-) Decreases the value of the blinking digit.

SAMPLE key Select the digit to blink.

PRINT key Stores the setting and proceeds to step 8 after **End** is displayed.

CAL key Cancels the setting and proceeds to step 8.

Finishing checking/setting

- The next item (**LP Fnc**) is displayed. Press the **CAL** key to finish.

Continue from the previous page

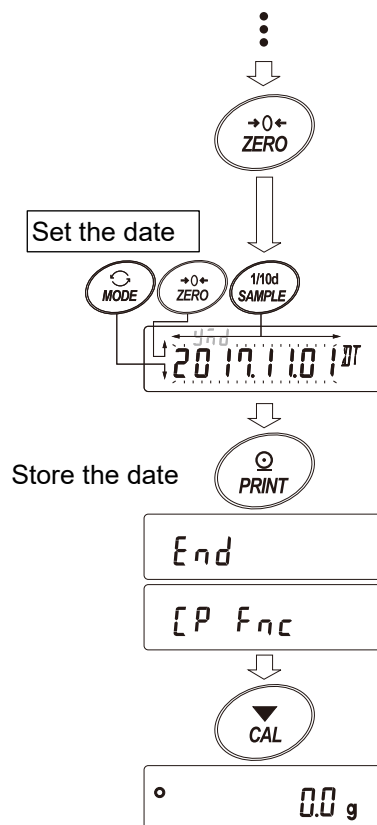

Caution:

Do not enter invalid values such as a non-existing date when setting the time and date.

The balance displays **rtc PF** when the clock backup battery has been depleted.

Battery replacement must be repaired by your local A&D dealer. Even if the backup battery of the clock runs out, it does not affect the functions other than the clock and calendar function. The clock and calendar function works normally if the balance is powered with the AC adapter. Press any key to set the time and date.

9-5. Comparator function

For comparison using the comparator function, either 3-stage or 5-stage can be selected ([P Fnc, [P-t). The 3-stage comparator is selected by default, and the [HI] / [OK] / [LO] indicator will be displayed according to the result of comparison. When the 5-stage comparator is selected, "HH" and "LL" become available with the [HI] and [LO] indicators respectively displayed blinking. With the optional GXL-04, comparison results can be output to the contact.

There are three operating ranges:

- No comparison
- Comparison when stable or overloaded
- Continuous comparison

There are six levels of conditions for comparing near zero, from "including near zero" to "± 100 d".

The criteria for comparison are "upper limit and lower limit value" and "reference value and tolerance range".

There are two ways to input the values: "digital input" and "input by sample load".

Refer to the function table [P Fnc].

With the function table [P bEEP], it is also possible to sound a built-in buzzer according to the comparison result.

3-stage comparison result

Threshold value	Weighing value ↑	Judgment formula	3-step comparison - display			
			Judgment result	Lit display	Blinking display	Buzzer control
Upper limit		Upper limit < Weighing value	HI	[HI]	/	bEP Hi
Lower limit		Lower limit ≤ Weighing value ≤ Upper limit	OK	[OK]	/	bEP ok
		Weighing value < Lower limit	LO	[LO]	/	bEP Lo

5-stage comparison result

Threshold value	Weighing value ↑	Judgment formula	5-step comparison - display			
			Judgment result	Lit display	Blinking display	Buzzer control
2 nd upper limit		2 nd upper limit < Weighing value	HH	/	[HI]	bEP HH
Lower limit		Upper limit < Weighing value ≤ 2 nd upper limit	HI	[HI]	/	bEP Hi
2 nd lower limit		Lower limit ≤ Weighing value ≤ Upper limit	OK	[OK]	/	bEP ok
		2 nd lower limit ≤ Weighing value < Lower limit	LO	[LO]	/	bEP Lo
		Weighing value < 2 nd lower limit	LL	/	[LO]	bEP LL

Caution

- At the factory setting, the comparator function in the flow rate measurement mode (PPF 3) compares the flow rate.
If "[P-Frd]" is set to "1" in the "[P Fnc]" of the function table, comparisons in weighing values (unit: g) can also be performed.

Selecting the comparator (3-stage/5-stage)

1. Press and hold the **SAMPLE** key for 2 seconds to display **bASFnC** of the function table.

2. Press the **SAMPLE** key several times until **[P Fnc]** is displayed.

3. Press the **PRINT** key.

4. Press the **SAMPLE** key several times until **[P-t]** is displayed.

5. Press the **ZERO** key to select “ 0 ” for 3-stage comparator, or “ | ” for 5-stage comparator.
Press the **PRINT** key to set.

6. Press the **CAL** key to return to weighing mode.

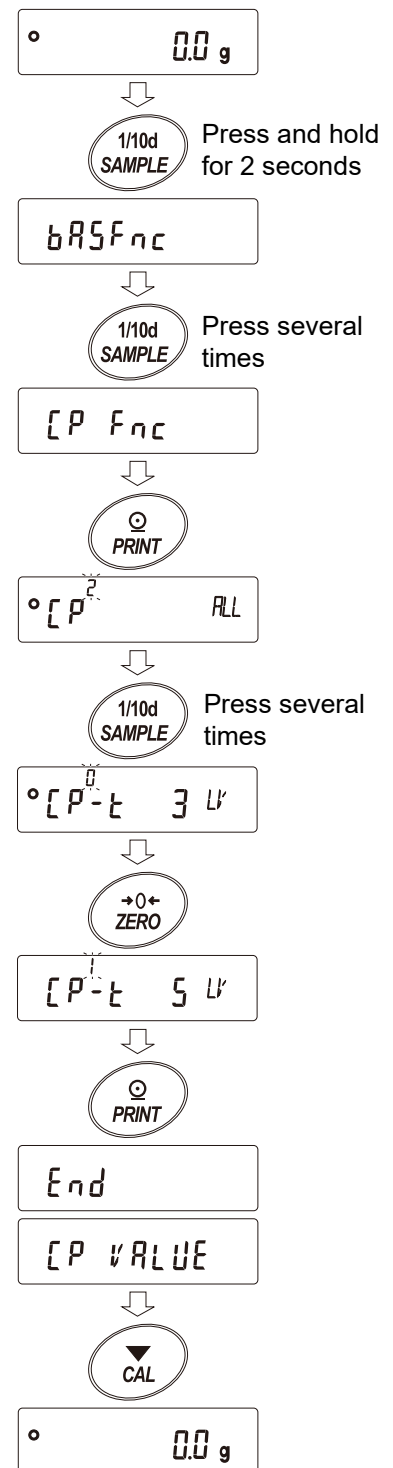

Setting example 1. Comparison when stable or overloaded. Upper/lower limits digital input.

Selecting a comparison method (operating range, comparison criteria, and value input) (Setup procedures starting from the factory default setting) (with the 3-stage comparator, comparison when stable or overloaded excluding near zero ± 10 d, upper limit 10005.0g and lower limit 9995.0g)

7. Press and hold the **SAMPLE** key for 2 seconds to display **bASFnC**.

8. Press the **SAMPLE** key several times until **CPFnC** is displayed.

9. Press the **PRINT** key.

10. Press the **ZERO** key several times **CP $\frac{1}{10d}$ tAb** is displayed.
(" / " for continuous comparison).

11. Press the **PRINT** key to store the selected method.

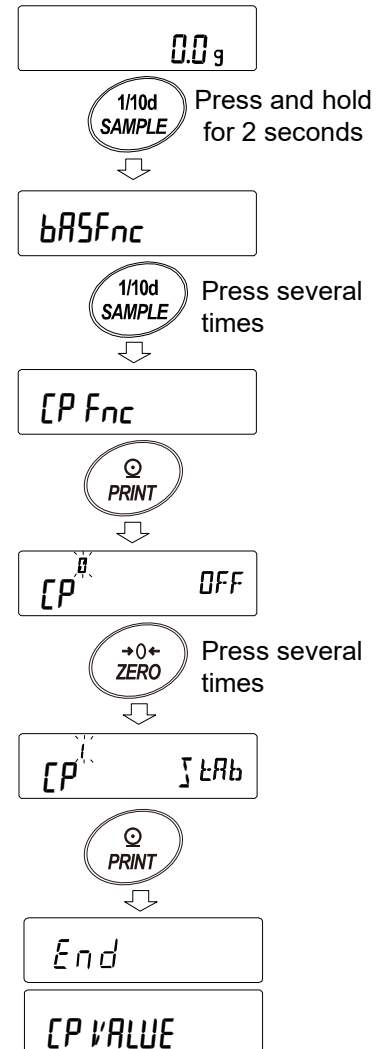

Entering the values

12. With **CP VALUE** displayed, press the **PRINT** key.

13. **CP Hi** appears.

14. Press the **PRINT** key.

15. The currently set value is displayed with all the digits blinking.

To continue with the set value, press the **PRINT** or **CAL** key to proceed to step 10.

To change the set value, press the **ZERO** key. Use the following keys:

SAMPLE key ... Select the digit to blink.

ZERO key Changes the value of the blinking digit.

MODE key Reverses the polarity.

PRINT key Stores the setting and proceeds to step 10.

CAL key Cancels the setting and proceeds to step 10.

16. **CP Lo** appears.

17. Press the **PRINT** key.

The currently set value is displayed with all the digits blinking.

To continue with the set value, press the **PRINT** or **CAL** key to proceed to step 13.

To change the set value, press the **ZERO** key. Use the following keys:

SAMPLE key ... Select the digit to blink.

ZERO key Changes the value of the blinking digit.

MODE key Reverses the polarity.

PRINT key Stores the setting and proceeds to step 13.

CAL key Cancels the setting and proceeds to step 13.

18. Press the **CAL** key twice to return to weighing mode.

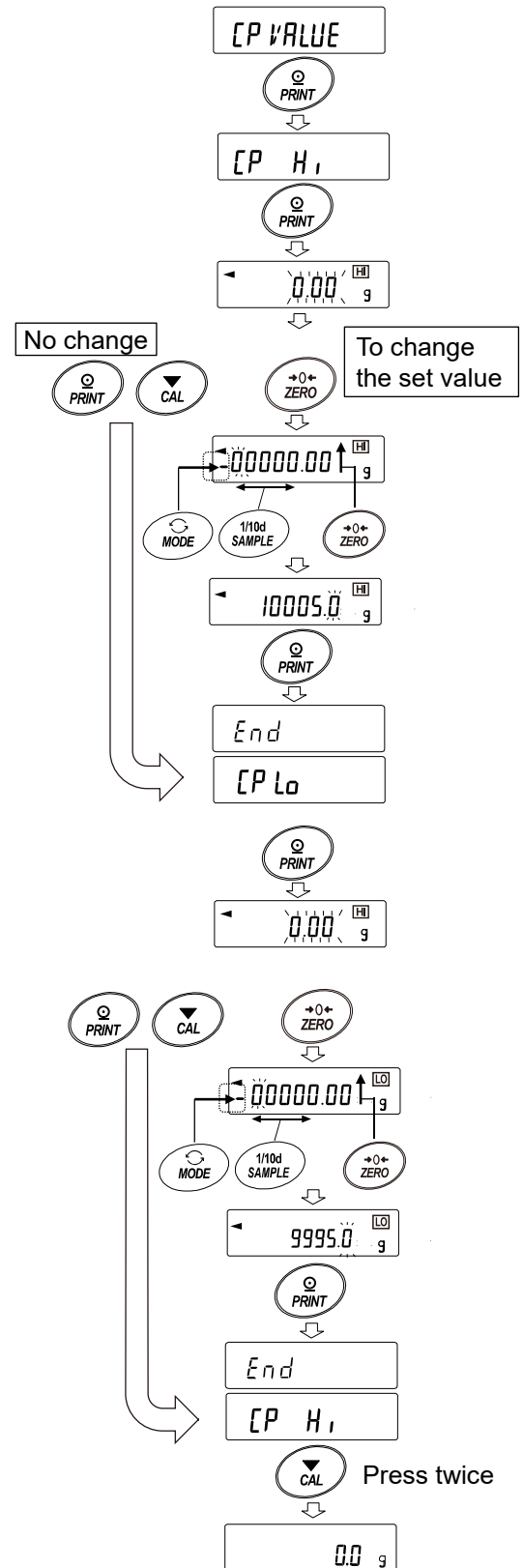

Setting example 2. Continuous comparison except near zero ± 20 d. Reference / tolerance digital input.

Selecting a comparison method (operating range, comparison criteria, and value input)

1. Press and hold the **SAMPLE** key for 2 seconds to display **bRSFnC** of the function table.
2. Press the **SAMPLE** key several times to display **[P Fnc]**.
3. Press the **PRINT** key.
4. Press the **ZERO** key several times to display **[P ALL]**. ("2" for continuous comparison).
5. Press the **SAMPLE** key several times to display **[P-2]**.
6. Press the **ZERO** key several times to display **[P-2 Ex 20d]**. ("3" for ± 20 d are not compared).
7. Press the **SAMPLE** key several times to move to the item **[P in]**.
8. Press the **ZERO** key several times to display **[P in rEF DIG]**. ("2" for reference value, digital input).
9. Press the **PRINT** key to store the selected method.

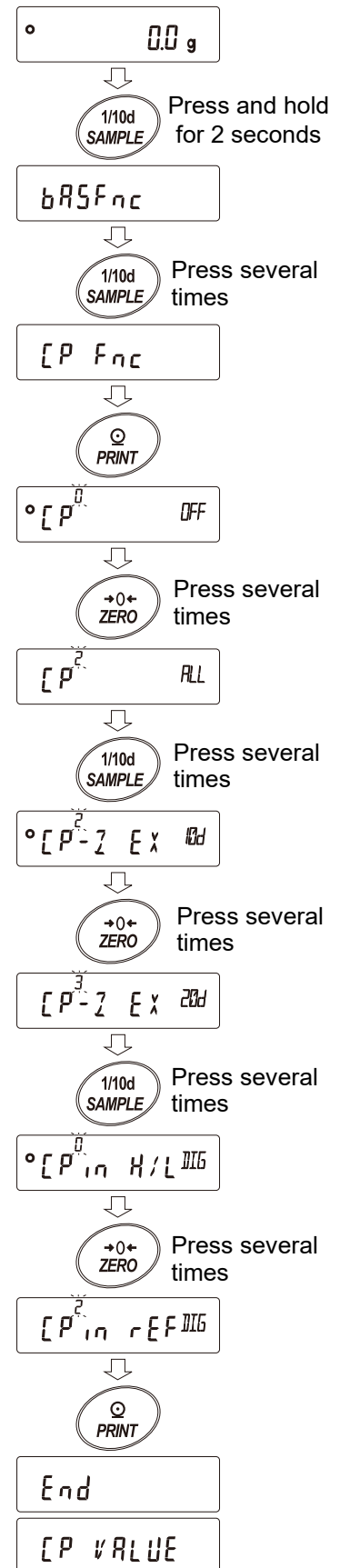

Entering the values

10. With **CP VALUE** displayed, press the **PRINT** key.

11. **CP rEF** appears.

12. Press the **PRINT** key.

13. The currently set value is displayed with all the digits blinking.

To continue with the set value, press the **PRINT** or **CAL** key to proceed to step 14.

To change the set value, press the **ZERO** key.

Use the following keys:

SAMPLE key ... Select the digit to blink.

ZERO key Changes the value of the blinking digit.

MODE key Reverses the polarity.

PRINT key Stores the setting and proceeds to step 14.

CAL key Cancels the setting and proceeds to step 14.

14. With **CP LME** displayed, press the **PRINT** to display the currently set value.

To change the set value, use the following keys and store a tolerance value.

For the tolerance range, enter a value with the reference value as 100%.

SAMPLE key ... Select the digit to blink.

ZERO key (+) .. Changes the value of the blinking digit.

MODE key (-) .. Changes the value of the blinking digit.

PRINT key Stores the setting and proceeds to step 15.

CAL key Cancels the setting and proceeds to step 15.

15. Press the **CAL** key twice to return to weighing mode.

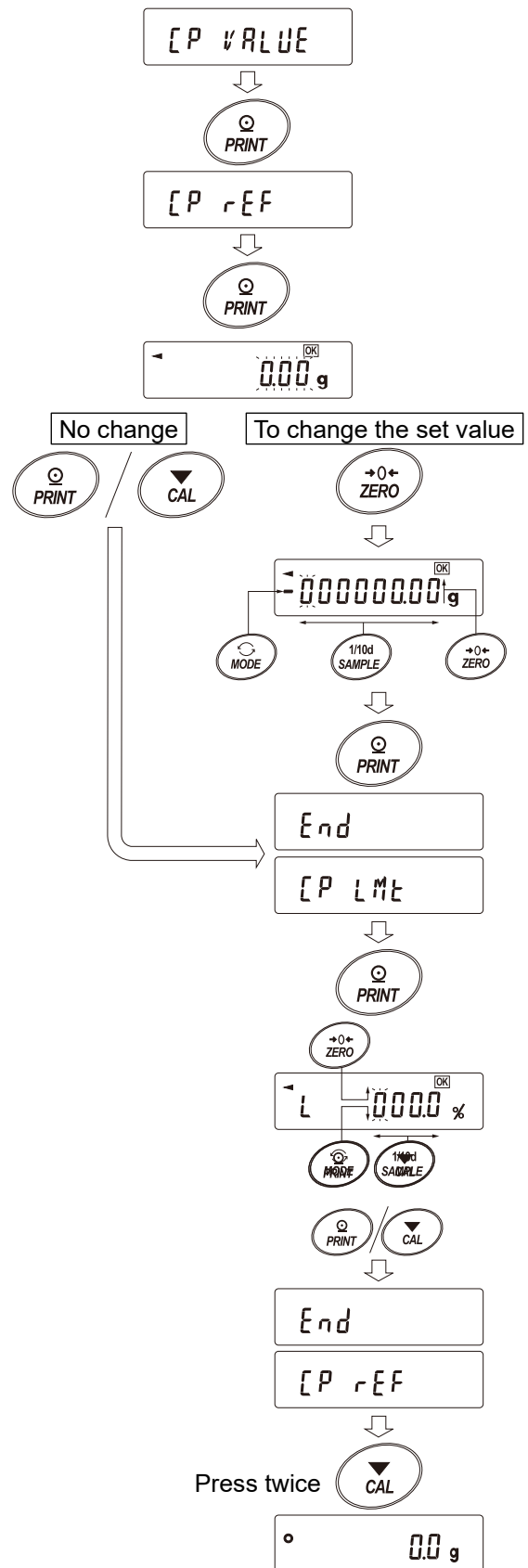

Setting example 3. Comparison when stable or overloaded including near zero. Upper/lower limits. Weighing input.

Selecting a comparison method (operating range, comparison criteria, and value input)

1. Press and hold the **SAMPLE** key for 2 seconds to display **bASFnC**.
2. Press the **SAMPLE** key several times to display **[P]FnC**.
3. Press the **PRINT** key.
4. Press the **ZERO** key several times to display **[P] [] LAb**. ("|" for comparison when stable or overloaded).
5. Press the **SAMPLE** key several times to display **[P-] []**.
6. Press the **ZERO** key several times to display **[P-] IN**. ("0" for also compare near zero).
7. Press the **SAMPLE** key several times to move to the item **[P] in**.
8. Press the **ZERO** key several times to display **[P] in H/L WT**. ("|" for weighing input, upper/lower limits).
9. Press the **PRINT** key to store the selected method.

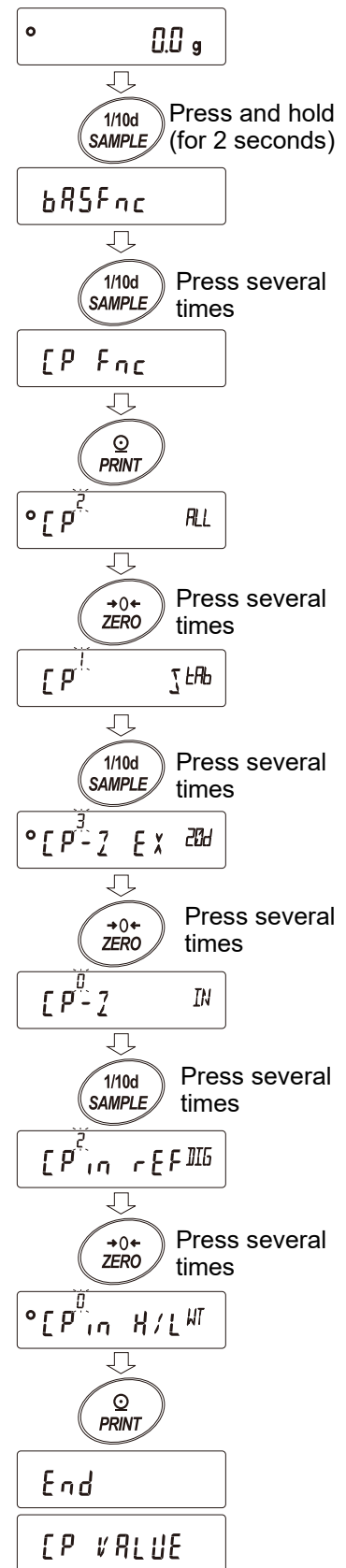

Entering the values

10. When **[P VALUE]** is displayed, press the **[PRINT]** key to display **[P H_i]**.

11. When **[P H_i]** is displayed, press the **[PRINT]** key to check the currently set value (all digits blinking).

12. Press the **[ZERO]** key to enter the load input mode.

[0.0 g] is displayed.

Place a sample of the upper limit weight on the balance and press the **[PRINT]** key. (Register the upper limit value.)

13. When finished, **[P L_o]** is displayed. (Remove the sample from the balance.)

14. When **[P L_o]** is displayed, press the **[PRINT]** key to check the currently set value (all digits blinking).

15. Press the **[ZERO]** key to enter the load input mode.

[0.0 g] is displayed.

Place a sample of the lower limit weight on the balance and press the **[PRINT]** key. (Register the lower limit value.)

16. When finished, **[P H_i]** is displayed. Remove the sample from the balance.

Press the **[CAL]** key twice to return to weighing mode.

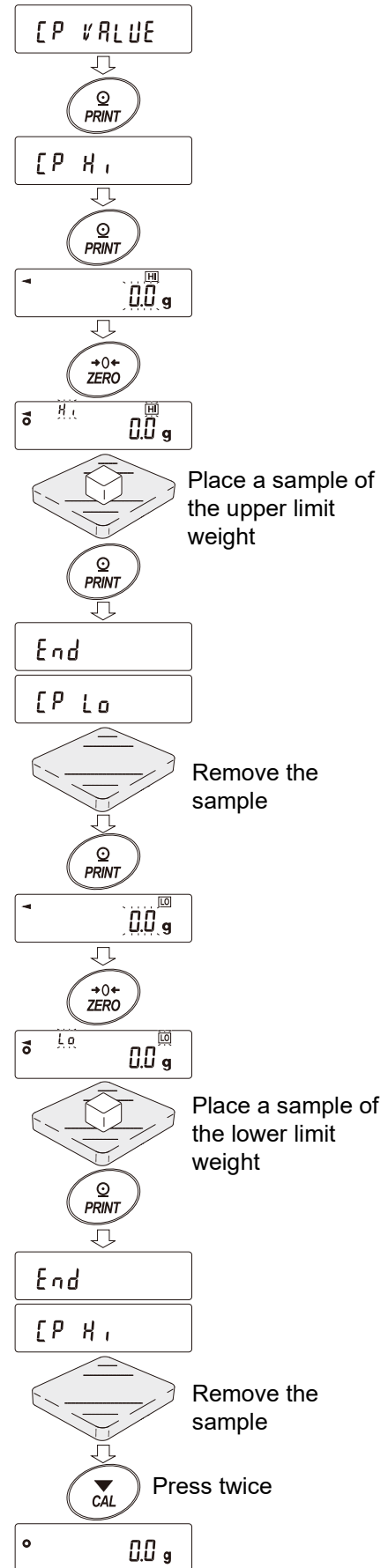

Sounding the built-in buzzer according to the comparison result

1. Press and hold the **[SAMPLE]** key for 2 seconds to display **bRSFnC** of the function table.
2. Press the **[SAMPLE]** key several times to display **[CP bEEP]**.
3. Press the **[PRINT]** key.
4. Press the **[SAMPLE]** key to set ON/OFF of the buzzer sound for the comparison judgment result.

When the 3-stage comparator is set, the following three options are available:

bEP H_i **bEP oK** **bEP Lo**

When the 5-stage comparator is set, the following five options are available:

bEP HH **bEP H_i** **bEP oK** **bEP Lo** **bEP LL**

[SAMPLE] key.....Selects the comparison judgment result.

[ZERO] keySets ON/OFF of the buzzer sound for the comparison judgment result.

[PRINT] key.....Stores the settings.

5. Press the **[PRINT]** key to store the buzzer sound settings for the comparison judgment results. After **[End]** is displayed, **dout** appears.
6. Press the **[CAL]** key to return to weighing mode.

Note

Regarding the setting of the comparator stage (**[P-t]**), refer to “[Selecting the comparator \(3-stage/5-stage\)](#)”.

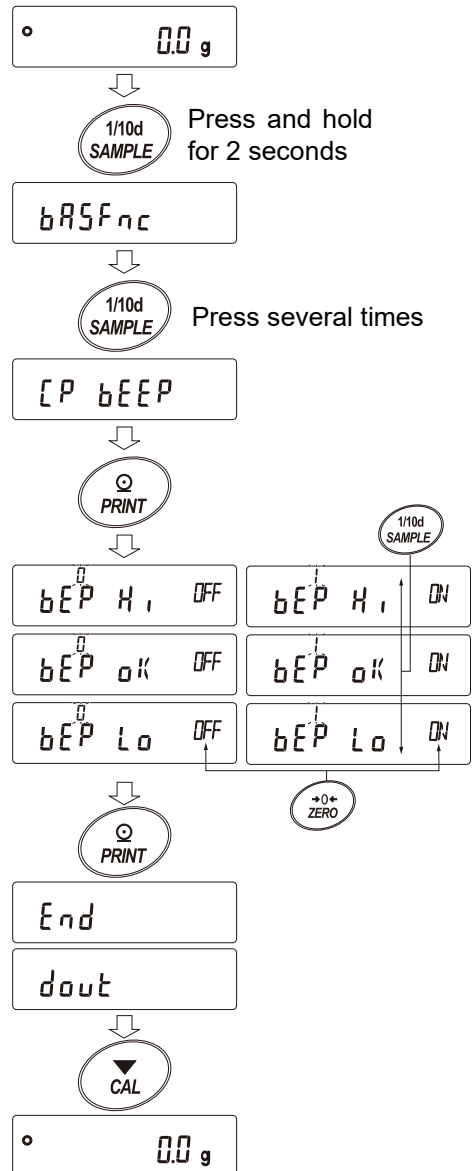

Adding the comparison results

By setting the "Comparison results (**[P-R]**)" of the function table to "1", the comparison results can be added to the data output using the RS-232C serial interface or USB interface. Use A&D standard format (**TYPE 0**). The comparison results are added after the header in A&D standard format as below.

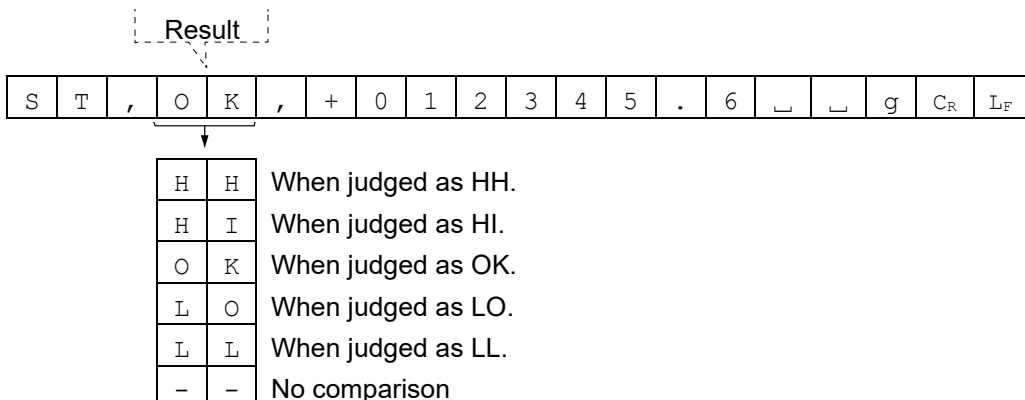

Comparator enlarged display function

The comparator enlarged display function displays the comparison results in a magnified way on the main portion of the display, in place of the weight value.

Selecting a unit of measurement

1. Press the **MODE** key to select a unit to be used for comparison.

Caution

While the comparator enlarged display function is in use, unit selection using the **MODE** key is not available.

Setting the function table for the comparator enlarged display function mode

2. Press and hold the **SAMPLE** key for 2 seconds to display **bASFnC** of the function table.

3. Press the **SAMPLE** key several times to display **[P Fnc**.

4. Press the **PRINT** key.

5. Press the **SAMPLE** key several times to display **[P-b OFF**.

6. Press the **ZERO** key to display **[P-b ON**.

Caution

To disable the comparator enlarged display function, change the set parameter (/) for "Comparator enlarged display function ([P-b)" to "0".

7. Press the **PRINT** key to store the setting.

8. Press the **CAL** key to return to weighing mode.

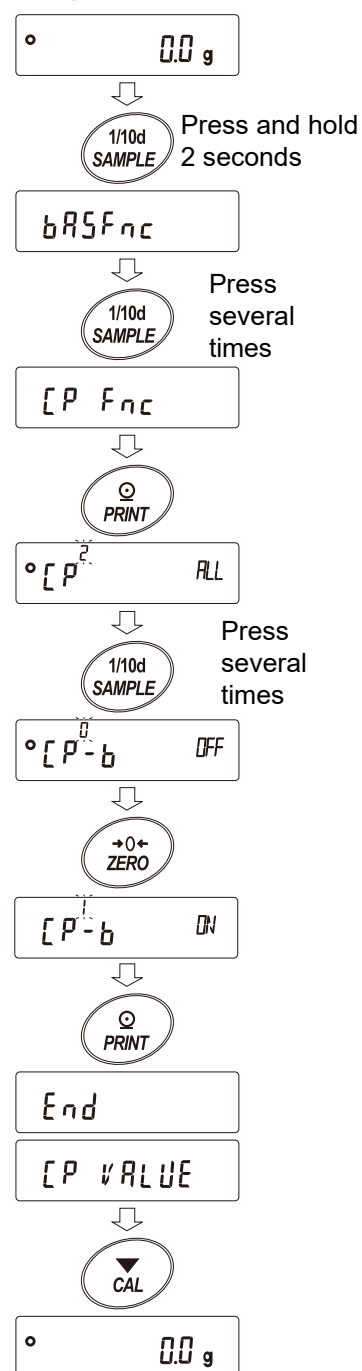

Comparator settings

Set the comparator as described in the previous section.

Setting example: **[P 3]** (Continuous comparison, excluding "near zero").

Using the comparator enlarged display function

1. Press the **[ZERO]** key to set the display to zero.
2. Place a sample on the weighing pan.
The balance performs a comparison using the set comparison values and displays the comparison results,

[HI] **[OK]** **[LO]**.

Each time the **[MODE]** key is pressed, the balance switches between the standard display and the comparator enlarged display (as shown in the figure on the right).

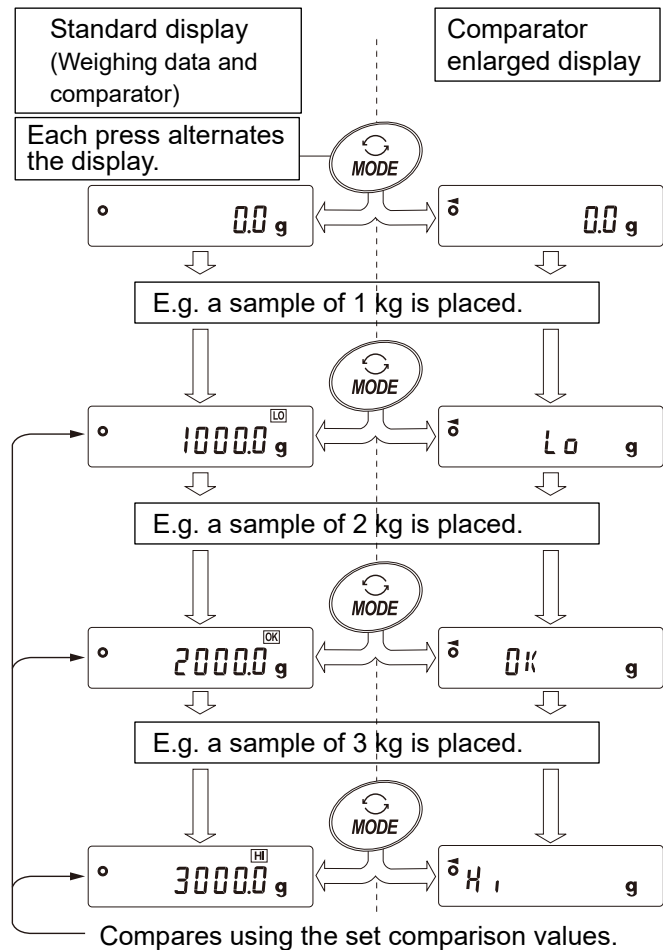

Caution

- While the comparator enlarged display function is in use, the processing indicator **[P]** illuminates.
- If the weighing value is at near zero or unstable and not being compared, the balance will display the weighing value even when the comparator enlarged display function is in use.
- Even when the comparator enlarged display function is in use, the balance re-zeroing and data output are possible.
- Only the unit that has been set (selected) prior to using the comparator enlarged display function can be used.
- When the comparator enlarged display function is in use, the data memory function for comparator setting value cannot be used.
- To disable the comparator enlarged display function, reset the parameter “ | ” of "Comparator enlarged display (**[P-b]**)” to “0” while referring to “[Setting the function table for the comparator enlarged display function mode](#)”.

9-6. Description of the item “Data output mode”

The data output timing of the balance can be switched by setting “Data output mode (*Prt*)” in the function table.

Key mode Setting *dout Prt 0*

When the PRINT key is pressed with the stabilization indicator turned on, the balance outputs the weighing data and the value display blinks one time.

Auto print mode A Setting *dout Prt 1*

The balance outputs the weighing data when the weighing value is stable beyond the range of “Auto print polarity (*RP-P*)” and “Auto print band width (*RP-b*)” from the reference zero point. When the PRINT key is pressed with the stabilization indicator turned on, the balance outputs the weighing data and the value display blinks one time.

Related settings:

<i>dout RP-P</i>	Auto print polarity
<i>dout RP-b</i>	Auto print band width

Auto print mode B Setting *dout Prt 2*

The balance outputs the weighing data when the weighing value is stable beyond the range of “Auto print polarity (*RP-P*)” and “Auto print band width (*RP-b*)” from the latest stable value. When the PRINT key is pressed with the stabilization indicator turned on, the balance outputs the weighing data and the value display blinks one time.

Related settings:

<i>dout RP-P</i>	Auto print polarity
<i>dout RP-b</i>	Auto print band width

Stream mode Setting *dout Prt 3*

The balance outputs weighing value at the “Display refresh rate (*SPd*)” regardless of the status of the stabilization indicator.

When *SPd 0* (approx. 5 times/second) is set, data is output at approx. 5.2 Hz.

Related settings

<i>bRSFnc SPd</i>	Display refresh rate
<i>SIF bPS</i>	Baud rate

Caution

- Depending on the display refresh rate and baud rate, data may not be completely transmitted unless the baud rate is increased.

Key mode B Setting *dout Prt 4*

When the PRINT key is pressed, the balance outputs the weighing data regardless of the status of the stabilization indicator.

Key mode C Setting *dout Prt 5*

When the PRINT key is pressed with the stabilization indicator turned on, the balance outputs the weighing data. When the PRINT key is pressed with the stabilization indicator turned off, the balance outputs the weighing data next time the stabilization indicator is turned on.

At this time, the value display blinks once to indicate that it has been output.

Interval mode Setting *dout Prt 6*

The balance outputs the weighing value at the "Interval time (*int*)" regardless of the state of the stabilization indicator.

Pressing the PRINT key starts data output. To stop, press the PRINT key again during the output.

Related settings:

<i>dout int</i>	Interval time
<i>S,F bPS</i>	Baud rate

Caution

- Depending on the interval time and baud rate, complete data may not be transmitted unless the baud rate is increased.

Auto print mode C Setting *dout Prt 7*

The balance outputs the weighing data when the weighing value is beyond the range of "Auto print polarity (*AP-P*)" and "Auto print band width (*AP-b*)" from the reference zero point and the comparator indicator shows OK with the stability indicator turned on. When the PRINT key is pressed with the stability indicator turned on, the balance outputs the weighing data and the value display blinks one time.

Example of use:

For automatic output of weighing data while adding samples to be weighed.

Related settings:

<i>dout Prt 7</i>	Mode C
<i>dout AP-P</i>	Auto print polarity
<i>dout AP-b</i>	Auto print band width
<i>[P Fnc] [P 1 to 4]</i>	Comparator mode
<i>[P H]</i>	Upper limit setting
<i>[P Lo]</i>	Lower limit setting

Tare weight output

The balance can output the gross weight, net weight, and tare weight data.

Display

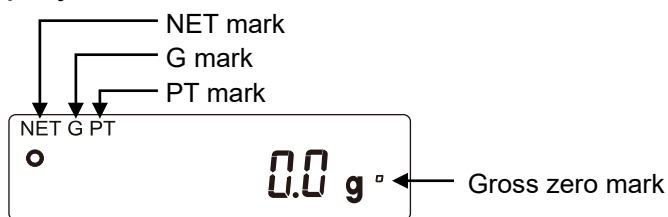

Mark	Description
NET	Lights up when the tare weight is other than zero.
G	Lights up when the tare weight is zero.
PT	Lights up together with the NET mark when the preset tare weight is set by PT command.
°	Lights up when the gross weight (total) readability in grams is in the range of zero.

Output

- Each time the PRINT key is pressed, net weight, gross weight, and tare weight are output in this order.
- Only A&D standard format, DP format, and CSV format are supported.

Output example (A&D standard format)

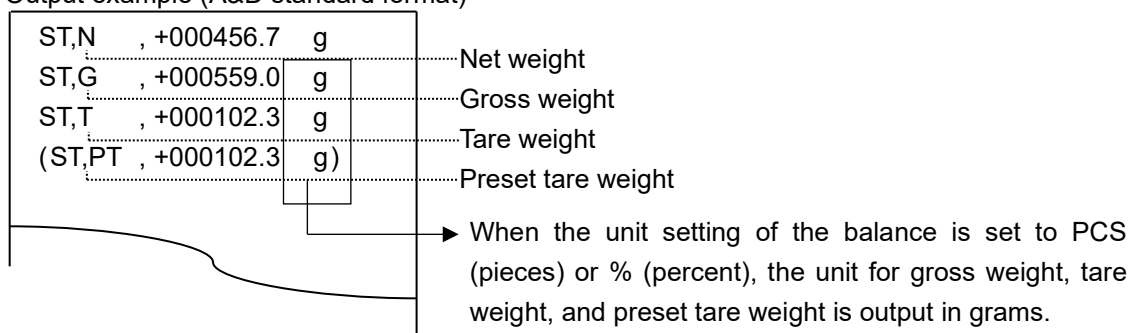

- To set the output contents or the order of output, use the UFC function. For the UFC function, refer to “[21-8. The UFC function](#)”.

9-7. Weighing data format

The output format of the balance's weighing data can be switched in the function table by setting "USB data format (U-LP)" for USB or, for RS-232C, "Data Format (TYPE)".

A&D standard format

RS-232C connection: Setting *SIF TYPE 0*

USB Connection: Setting *USB U-LP 0*

- ❑ This is the standard format for sending data to peripheral devices.
- ❑ Consists of 15 characters (excluding the terminator).
- ❑ The condition of the data is indicated with a 2-character header.
- ❑ The data is added with polarity and zeros (filling the data's higher order's surplus part with zeros).
- ❑ If the data is zero, the polarity is positive.
- ❑ The unit consists of three characters.

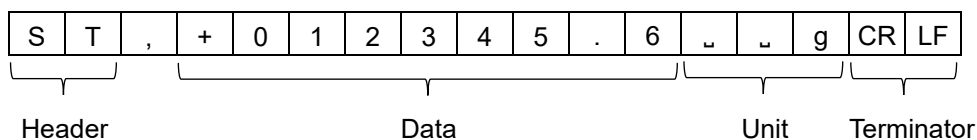

S	T	When stable			
U	S	When unstable	CR:	Carriage return	ASCII 0Dh
Q	T	When stable in counting mode	LF:	Line feed	ASCII 0Ah
O	L	When overloaded		: Space	ASCII 20h

- ❑ In the external key print mode of the AD-8127 multi-functional compact printer, a received A&D standard format is printed as shown below.

WT 12345.6 g

DP format (dump print)

RS-232C connection: Setting *SIF TYPE 1*

USB connection: Not supported

- ❑ This format is suitable for dump printing.
- ❑ Consists of 16 characters (excluding the terminator).
- ❑ The condition of the data is indicated with a 2-character header.
- ❑ The polarity sign is added just before the value if the value is not an overload or zero.
- ❑ The data is zero-suppressed (leading zeros are replaced with spaces).
- ❑ The unit consists of three characters.

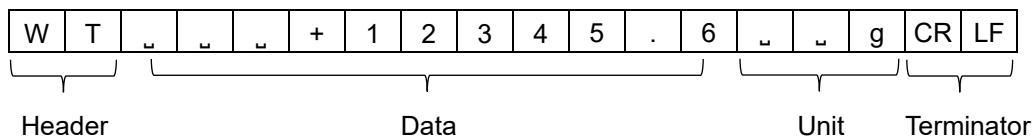

W	T	When stable	CR:	Carriage return	ASCII 0Dh
U	S	When unstable	LF:	Line feed	ASCII 0Ah
Q	T	When stable in counting mode		: Space	ASCII 20h

KF format

RS-232C connection: Setting *SIF TYPE 2*

USB connection: Not supported

- ❑ This is the Karl-Fischer moisture meter format.
- ❑ Consists of 14 characters (excluding the terminator).
- ❑ There are no headers.
- ❑ The polarity sign is added to the first character if the value is not an overload or zero.
- ❑ The data is zero-suppressed (leading zeros are replaced with spaces).
- ❑ When stable, the unit is output. When not stable, the unit is not output.

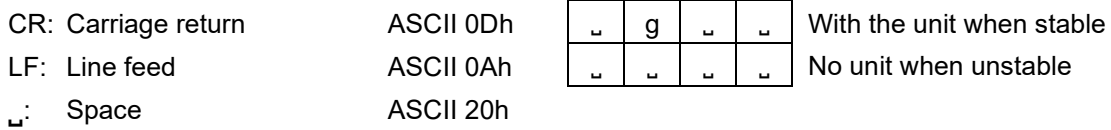
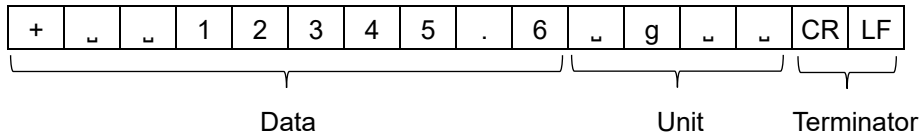

MT format

RS-232C connection: Setting *SIF TYPE 3*

USB connection: Not supported

- ❑ Used when connecting to devices manufactured by other companies. Note that there is no guarantee of compatibility.
- ❑ The length of data varies depending on the length of the unit.
- ❑ Has a two-character header.
- ❑ The data is zero-suppressed (leading zeros are replaced with spaces).

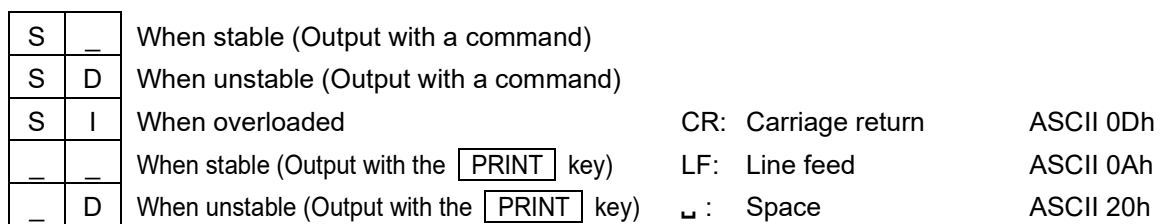
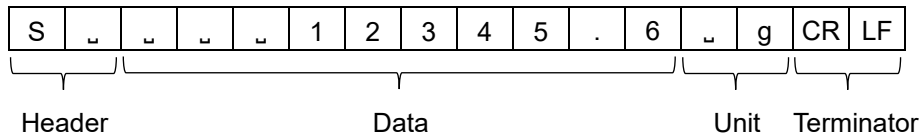

NU format

RS-232C connection: Setting *S/F TYPE 4*

USB communication: Setting *USB U-TP 1*

- Only numerical data of the weighing value is output.
- Consists of 9 characters (not including the terminator).
- The data is padded with polarity and zeros (filling the data's higher order's surplus part with zeros).
- If the data is zero, the polarity is positive.

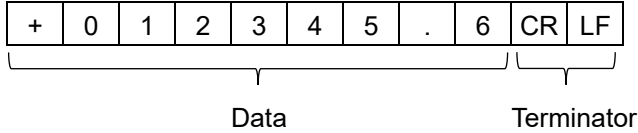

CSV format

RS-232C connection: Setting *S/F TYPE 5*

USB connection: Setting *USB U-TP 2*

- The data part and unit part of A&D standard format are separated by a separator ",".
- Outputs the unit even when overloaded.
- When the decimal comma (,) is set, a semicolon (;) will be used instead as a separator.

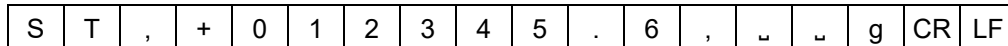

- When other data is added to the weighing value, all data will be displayed in one line.
The output sample is as follows if the ID number, data number, date and time are added.

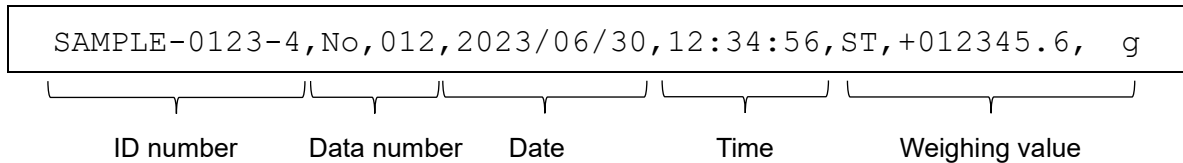

NU2 format

RS-232C connection: Setting *S/F 6*

USB connection: Setting *USB U-TP 4*

- Only numerical data of the weighing value is output.
- If the value is zero or positive, polarity is not added.

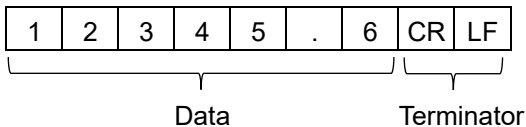

TAB format

RS-232C connection: Setting *S/F 7*

USB connection: Setting *USB U-TP 3*

- This is a format, in which the separator of the CSV format is changed from comma to TAB.

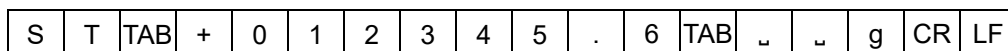

TAB: ASCII:09h

Other data formats

In addition to weighing data, various data can be added. Switch on / off each setting as necessary.

Data number

Setting *dout d-no 1*

- When the data memory function is used, the data number is output.
- Consists of 6 characters (not including the terminator).
- When NU or NU2 format is selected with the Quick USB mode, only the decimal point "." and number are output.

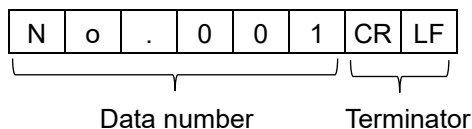

Quick USB connection (when outputting the numerical values only):

Setting *USB UFnC 0* and
U-tP 1 or *4*

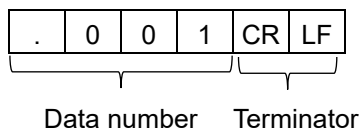

ID number

Setting *dout 5-id 1*

- The ID number stored in the balance is output.
- Consists of 13 characters (not including the terminator).
- When NU or NU2 format is selected with the Quick USB mode, only the hyphen "-" and number are output.

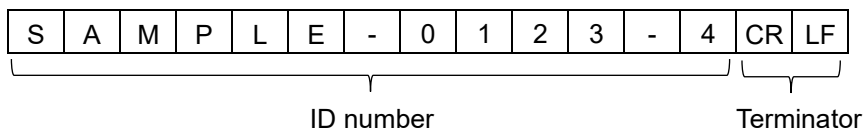

Quick USB connection (when outputting the numerical values only):

Setting *USB UFnC 0* and
U-tP 1 or *4*

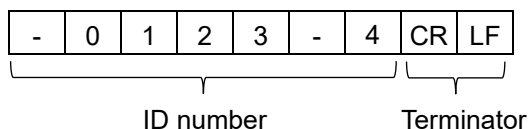

9-7-1. Output examples of weighing data format

When stable

3 1420.6 g

A&D	S	T	,	+	0	3	1	4	2	0	.	6	▬	▬	g	CR	LF	
DP	W	T			+	3	1	4	2	0	.	6	▬	▬	g	CR	LF	
KF	+	▬	▬	3	1	4	2	0	.	6	▬	▬	g	▬	CR	LF		
MT	S	▬	▬	▬	▬	3	1	4	2	0	.	6	▬	▬	g	CR	LF	
NU	+	0	3	1	4	2	0	.	6	CR	LF							
CSV	S	T	,	+	0	3	1	4	2	0	.	6	,	▬	▬	g	CR	LF
NU2	3	1	4	2	0	.	6	CR	LF									

When unstable

-2958.7 g

A&D	U	S	,	-	0	0	2	9	5	8	.	7	▬	▬	g	CR	LF	
DP	U	S	▬	▬	▬	▬	-	2	9	5	8	.	7	▬	▬	g	CR	LF
KF	-	▬	▬	▬	2	9	5	8	.	7	▬	▬	▬	▬	CR	LF		
MT	S	D	▬	▬	▬	-	2	9	5	8	.	7	▬	▬	g	CR	LF	
NU	-	0	0	2	9	5	8	.	7	CR	LF							
CSV	U	S	,	-	0	0	2	9	5	8	.	7	,	▬	▬	g	CR	LF
NU2	-	2	9	5	8	.	7	CR	LF									

When overloaded
(positive)

E g

A&D	O	L	,	+	9	9	9	9	9	9	E	+	1	9	CR	LF				
DP	▬	▬	▬	▬	▬	▬	▬	▬	E	▬	▬	▬	▬	▬	▬	▬	CR	LF		
KF	▬	▬	▬	▬	▬	H	▬	▬	▬	▬	▬	▬	▬	▬	▬	▬	CR	LF		
MT	S	I	+	CR	LF															
NU	+	9	9	9	9	9	9	9	9	CR	LF									
CV	O	L	,	+	9	9	9	9	9	9	E	+	1	9	,	▬	▬	g	CR	LF
NU2	+	9	9	9	9	9	9	9	9	CR	LF									

When overloaded
(negative)

-E g

A&D	O	L	,	-	9	9	9	9	9	9	E	+	1	9	CR	LF				
DP	▬	▬	▬	▬	▬	▬	-	E	▬	▬	▬	▬	▬	▬	▬	▬	▬	CR	LF	
KF	▬	▬	▬	▬	▬	-	L	▬	▬	▬	▬	▬	▬	▬	▬	▬	▬	CR	LF	
MT	S	I	-	CR	LF															
NU	-	9	9	9	9	9	9	9	9	CR	LF									
CV	O	L	,	-	9	9	9	9	9	9	E	+	1	9	,	▬	▬	g	CR	LF
NU2	-	9	9	9	9	9	9	9	9	CR	LF									

9-8. Description of application mode

Normal weighing mode (APF 0)

This is the normal weighing mode set at the factory.

Capacity indicator mode (APF 1)

In this mode, the balance displays the relation between the load and weighing capacity in percent for normal weighing.

(Zero: 0%. Weighing capacity: 100%.)

Caution

- This mode cannot be used when the data memory function (dRR) “ 1 ” or “ 2 ” is set.

Statistical calculation mode (APF 2)

In this mode, the balance performs statistical calculation of weighing values and displays/outputs the results.

For details, refer to “[12. Statistical Calculation Mode](#)”.

Flow rate measurement mode (APF 3)

In this mode, the balance calculates flow rate (change in weighing values over time).

For details, refer to “[13. Flow Rate Measurement](#)”.

9-9. Storing units

The units or modes can be selected and stored in the function table. The sequence of displaying the units or modes can be arranged to fit the frequency of use.

The units stored are maintained in non-volatile memory, even if the AC adapter is removed.

Setting procedure

Select a unit or mode and arrange the sequence of display as follows:

- Press and hold the **SAMPLE** key for 2 seconds to display **bASFnC** of the function table, then release the key.
- Press the **SAMPLE** key several times to display **Unit**.
- Press the **PRINT** key to enter the unit selection mode.
- Specify a unit or mode in the order to be displayed using the following keys.
 - SAMPLE** key.....Displays the units sequentially.
 - ZERO** key.....Specifies a unit or mode.

The stabilization indicator  appears when the displayed unit or mode is specified.
If the key is pressed in units already selected, the stability mark disappears.
- Press the **PRINT** key to store the units or modes. The balance displays **End** and then displays the next menu of the function table.
- Press the **CAL** key to exit the function table. Then the balance returns to weighing mode with the selected unit.
- To select other unit or mode for weighing, press the **MODE** key.

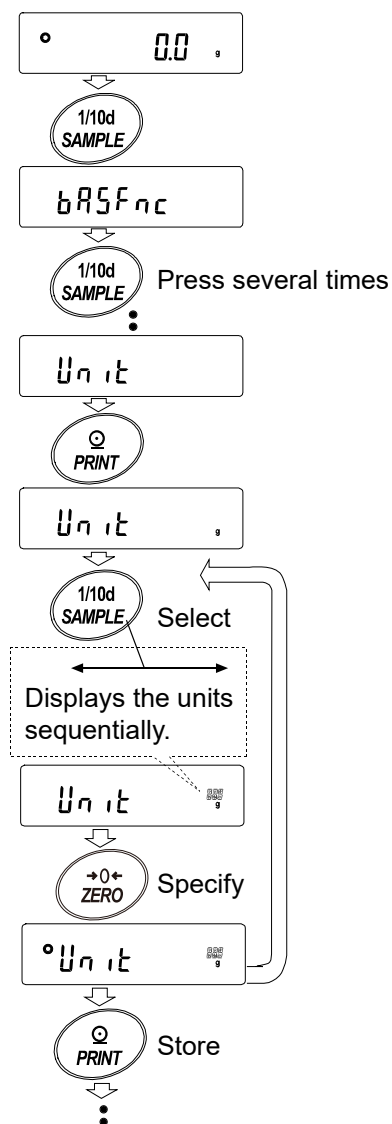

Unit setting example

The example below sets the units in the order with g (gram) as the first unit followed by pcs (counting mode).

1. Press and hold the **SAMPLE** key for 2 seconds to display **bRSFnC** of the function table, and then release the key.
2. Press the **SAMPLE** key several times to display **Unit**.
3. Press the **PRINT** key to enter the unit selection mode.
4. Press the **ZERO** key to specify the unit of g
The stabilization indicator **○** appears when the unit is specified.
5. Press the **SAMPLE** key to display **Unit PCS**.
6. Press the **ZERO** key to specify the unit of pcs.
The stabilization indicator **○** appears when the unit is specified.
7. Press the **PRINT** key to store the units.
The balance displays **End** and then displays the next menu item of the function table.
8. Press the **CAL** key to exit the function table. Then the balance returns to the weighing mode with g, the unit selected first.
9. Press the **MODE** key to switch between g and pcs (g→pcs).

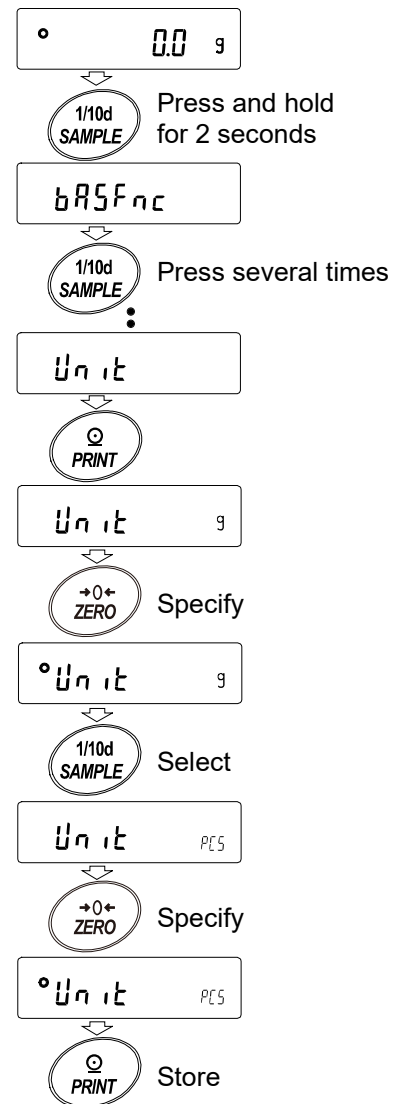

10. ID Number and GLP Report

10-1. Main objective

- The data output compliant with "GLP/GMP" can be output to a personal computer or optional printer using interfaces such as RS-232C.
- The balance can output the following GLP/GMP compliant reports via RS-232C or USB.
 - Sensitivity adjustment report (Output for sensitivity adjustment using the internal weight [automatic sensitivity adjustment and sensitivity adjustment])
 - Sensitivity adjustment report (Output for sensitivity adjustment using the external weight)
 - Calibration test report (Output for calibration test using the external weight)
 - Breaks ("title block" and "end block") for easy management of a series of weighing data.
- The GLP/GMP compliant report includes the balance manufacturer (A&D), model name, serial number, ID number, date, time, and space for signature. For a sensitivity adjustment or calibration test, the result and the weight used are also included.
- Changing the function table enables the balance to store sensitivity adjustment report and calibration test temporarily in data memory in order to output all at once.
Note For the setting, refer to "[11. Data Memory](#)".
- The ID number can be used as an identification number for the balance during maintenance of the balance.
- The ID number is stored in non-volatile memory even if the AC adapter is removed, and is valid until a new registration is made.
- For confirmation and setting of the time and date, refer to "[9-4. Clock and calendar function](#)" in "[9. Function Table](#)".
- When printing GLP output with an external device such as a printer connected to the balance, the clock function of the device can be used to print the time and date. (Function table "[Fn 2](#)").

10-2. Setting the ID number

1. Press and hold the **SAMPLE** key for 2 seconds to display **bASFnC** in the function table mode.
2. Press the **SAMPLE** key several times to display **id**.
3. Press the **PRINT** key. Set the ID number using the following keys.
 - SAMPLE** keySelects the digit to blink.
 - ZERO** key, **MODE** keyChanges the character of the selected (blinking) digit.
 - PRINT** key.....Stores the new ID number and displays **PASSwd**.
 - CAL** keyCancels the new ID number and displays **PASSwd**.
4. With the next item **PASSwd** displayed, press the **CAL** key to return to weighing mode.

Note

- There are four types of segment displays on the balance display. For each type of segment display, refer to “[Display correspondence table](#)” below.

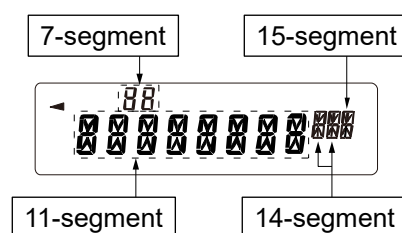

Display correspondence table

11-segment

0	1	2	3	4	5	6	7	8	9	-	□	A	B	C	D	E	F	G	H	I	J	K	L	M	N	O	P	Q	R	S	T	U	V	W	X	Y	Z
0	1	2	3	4	5	6	7	8	9	-	□	A	B	C	D	E	F	G	H	I	J	K	L	M	N	O	P	Q	R	S	T	U	V	W	X	Y	Z

Space

7-segment

0	1	2	3	4	5	6	7	8	9	-	□	A	B	C	D	E	F	G	H	I	J	K	L	M	N	O	P	Q	R	S	T	U	V	W	X	Y	Z
0	1	2	3	4	5	6	7	8	9	-	□	A	B	C	D	E	F	G	H	I	J	K	L	M	N	O	P	Q	R	S	T	U	V	W	X	Y	Z

Space

14-segment

0	1	2	3	4	5	6	7	8	9	-	□	A	B	C	D	E	F	G	H	I	J	K	L	M	N	O	P	Q	R	S	T	U	V	W	X	Y	Z
0	1	2	3	4	5	6	7	8	9	-	□	A	B	C	D	E	F	G	H	I	J	K	L	M	N	O	P	Q	R	S	T	U	V	W	X	Y	Z

Space

15-segment

0	1	2	3	4	5	6	7	8	9	-	□	A	B	C	D	E	F	G	H	I	J	K	L	M	N	O	P	Q	R	S	T	U	V	W	X	Y	Z
0	1	2	3	4	5	6	7	8	9	-	□	A	B	C	D	E	F	G	H	I	J	K	L	M	N	O	P	Q	R	S	T	U	V	W	X	Y	Z

Space

10-3. GLP report

To output GLP/GMP data and the like with an AD-8127 compact printer or PC, set to **inFd 1** (output the clock data built into the balance) or **inFd 2** (output the clock data of the external device) in the function table.

Note

- If the date/time is incorrect with **inFd 1** (use the clock data built into the balance), adjust the date/time with **[L Add]** (Clock) in the function table.

Examples of sensitivity adjustment report using the internal weight

This is the GLP report when the sensitivity of the balance is adjusted using the internal weight.

- Output the clock data built into the balance “ *inF0 1* ”.

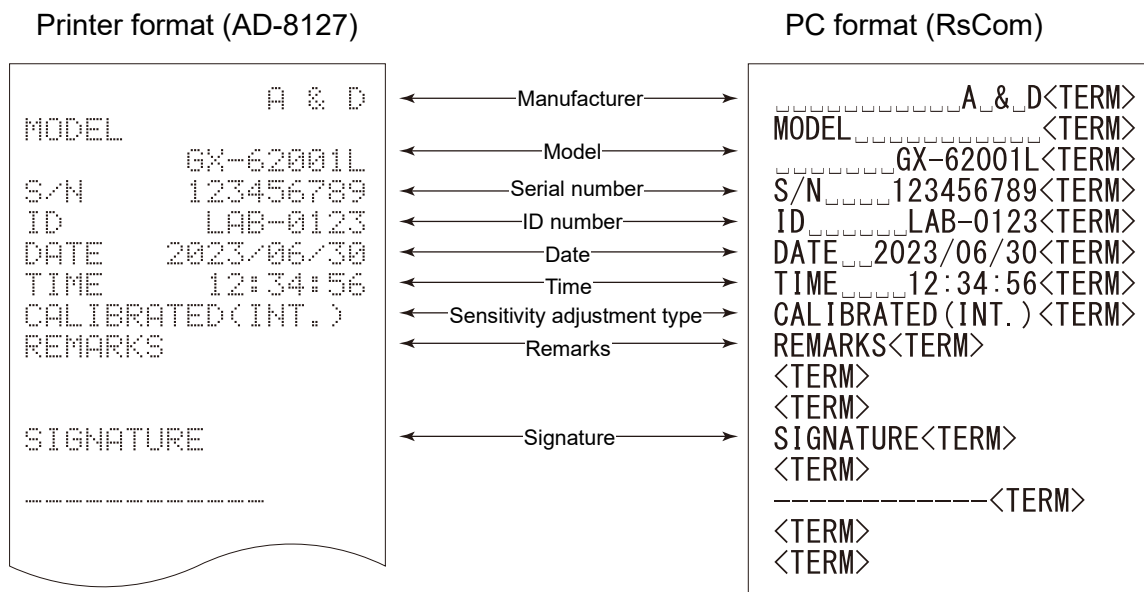

□ : Space, ASCII 20h

CR: Carriage return, ASCII 0Dh

<TERM> : Terminator, CR LF or CR

LF: Line feed, ASCII 0Ah

- Output the clock data of the external device “ *inF0 2* ”.

When outputting data such as that for GLP/GMP, setting the function table “ *inF0 2* ” enables use of the clock data of the external device such as a PC or printer instead of the clock data built into the balance. Use this function to unify clock data with the clock function of an external device.

Caution

- The function to output the clock data of external devices can be used with devices that have a clock function and can output the date and time in response to <ESC>D and <ESC>T. (e.g. AD-8127 compact printer, RsCom [WinCT])
- For sensitivity adjustment history storage of the data memory function, the clock data built into the balance is saved even when “ *inF0 2* ” is set.

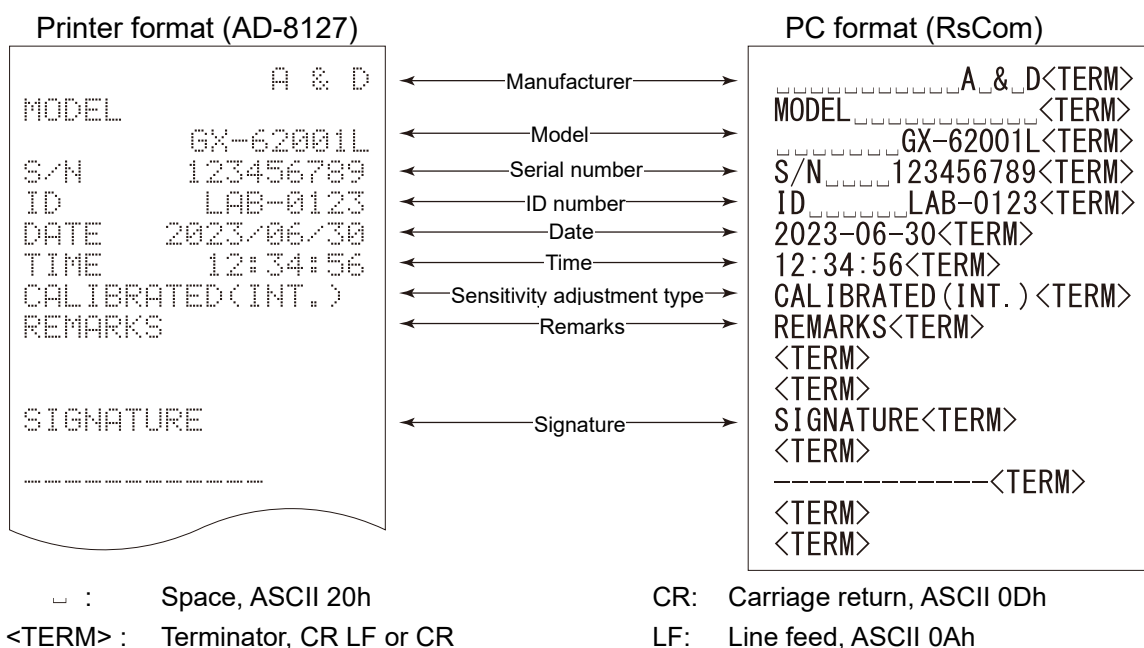

□ : Space, ASCII 20h

CR: Carriage return, ASCII 0Dh

<TERM> : Terminator, CR LF or CR

LF: Line feed, ASCII 0Ah

Examples of sensitivity adjustment report using an external weight

This is the GLP report when the sensitivity of the balance is adjusted using the external weight. When " mF0 / " is set.

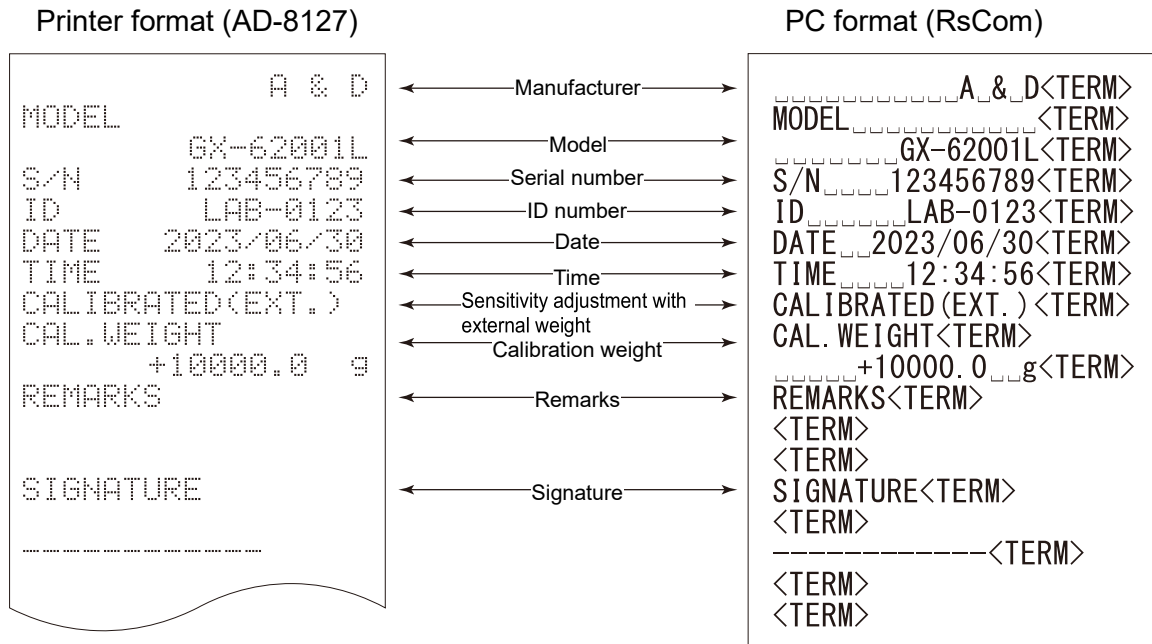

□ : Space, ASCII 20h
 <TERM> : Terminator, CR LF or CR

CR: Carriage return, ASCII 0Dh
 LF: Line feed, ASCII 0Ah

Calibration test using an external weight

This is the GLP report when checking the weighing accuracy of the balance with an external weight. (Adjustment is not performed)

When " mF0 / " is set:

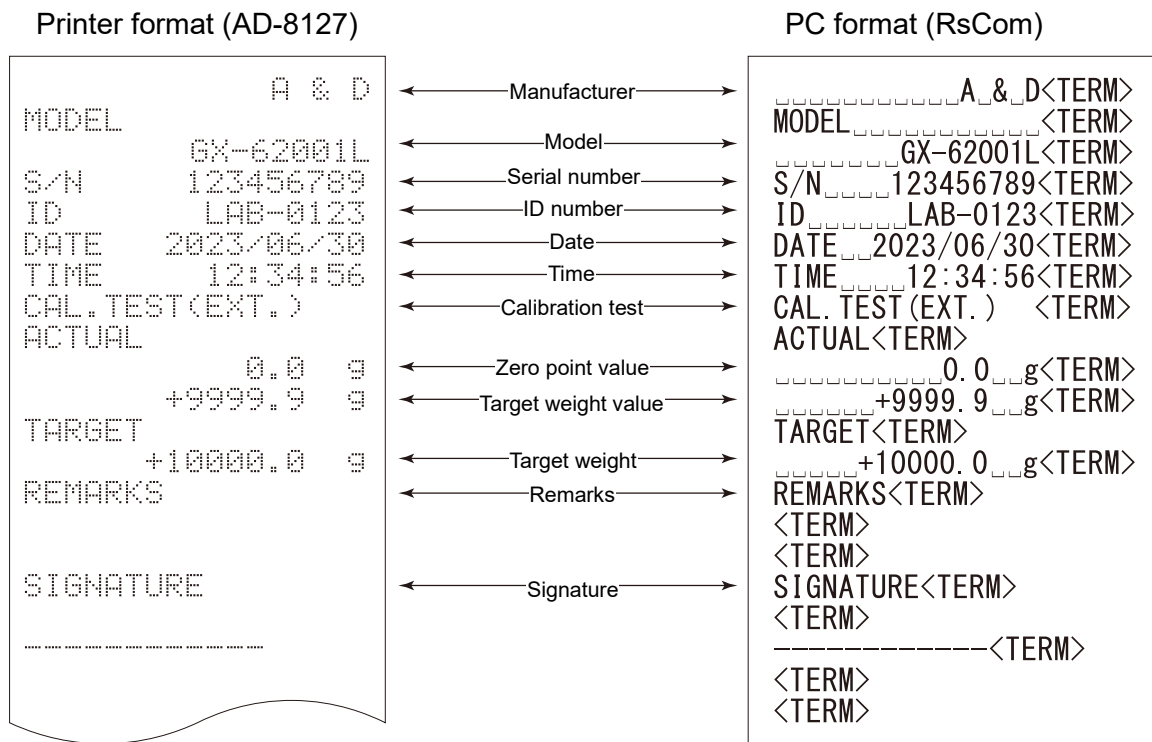

□ : Space, ASCII 20h
 <TERM> : Terminator, CR LF or CR

CR: Carriage return, ASCII 0Dh
 LF: Line feed, ASCII 0Ah

Title block and end block

Application / Operation

“Title block” and “End block” can be added before and after a series of weighing values for data management.

Pressing and holding the **PRINT** key for 2 seconds outputs "Title block" and "End block" alternately.

Note

- If the data memory function is used (when other than “**DATA 0**”), Title block and End block cannot be output.

Output method using the keys

1. With the weighing value displayed, pressing and holding the **PRINT** key for 2 seconds displays **Start** and outputs "Title block".
2. Output the weighing value. The output method depends on the setting of the data output mode.
3. Press and hold the **PRINT** key for 2 seconds until **RecEnd** is displayed to output "End block".

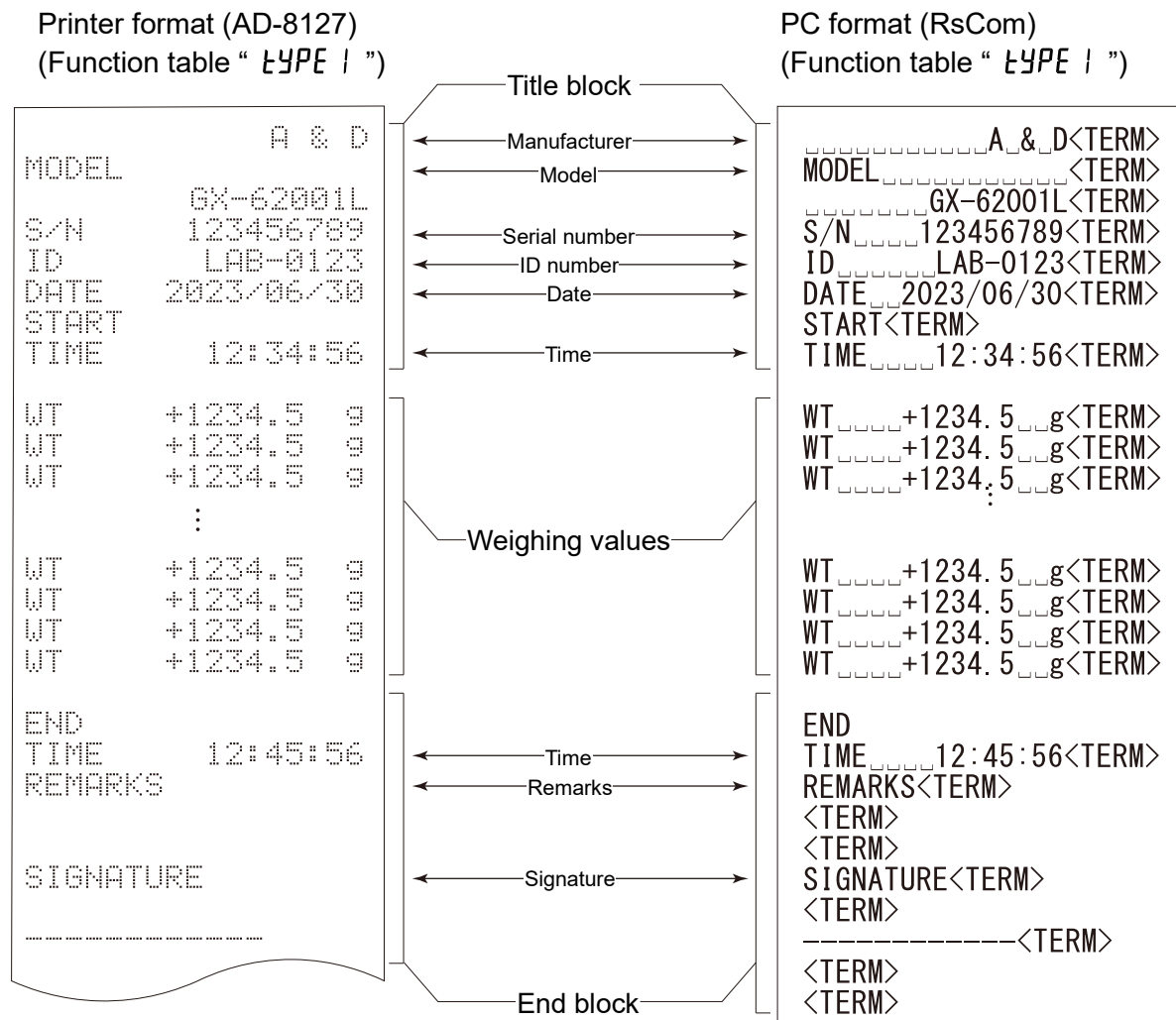

□ : Space, ASCII 20h
<TERM> : Terminator, CR LF or CR

CR: Carriage return, ASCII 0Dh
LF: Line feed, ASCII 0Ah

11. Data Memory

Data memory is a function to store in the balance unit weights for counting mode, weighing results, sensitivity adjustment results, etc., and afterward to perform data confirmation or batch output.

The following five types of data can be stored.

Unit weights (Counting mode)	Up to 50 sets
Weighing values	Up to 200 results
Sensitivity adjustment history Internal weight sensitivity adjustment report (GX-L series only) External weight sensitivity adjustment report External weight calibration test report	Latest 50 sets
Comparator settings Upper limit and lower limit only	Up to 20 sets
Tare values	Up to 20 sets

Caution

- Cannot be used together with the statistical calculation function, tare value output function, or minimum weight alert function.

11-1. Data memory for weighing data

Features

- Weighing results can be stored in the internal memory of the balance.
- The balance can store weighing results so that you can continue weighing work without a printer or a personal computer connected.
- The balance can store weighing results so that you can perform weighing work without occupying a printer or PC for a long time.
- Stored data can be displayed on the balance for data confirmation.
- Stored data can be output in batch (to a PC or optional printer). The output format and whether to add a data number, time/date, and ID number can be selected with the function table. Stored data can be output in batch (to a PC or optional printer). The output format and whether to add a data number, time/date, and ID number can be selected with the function table.
- The balance has a capacity to store up to 200 weighing results with timestamp.

Note For how to store unit weights, refer to "4-3. Counting mode (PCS)".

Storing the weighing results and sensitivity adjustment results

1. Set the "Data memory (dMEm)" in the function table to "Stores weighing data and sensitivity adjustment history (dMEm 2)". Refer to "9. Function Table" and the following "Enabling data memory function".
2. With "Time/Date output (S-Ed)" of the function table, set whether to add timestamp.

How to store the weighing results depends on the operation of "Data output mode (PrE)" of the function table. When PrE 3 (stream mode) is set, data may not be stored correctly.

Note The time and date settings can be changed after the weighing values are stored.

Enabling data memory function

1. Press and hold the **SAMPLE** key for 2 seconds to display **bASFnC**.
2. Press the **SAMPLE** key several times to display **dout**.
3. Press the **PRINT** key.
4. Press the **SAMPLE** key several times to display **dAtA**.
5. Press the **ZERO** key to display **dAtA Wt/ CAL**.
6. Press the **PRINT** key to store the setting.
7. Press the **CAL** key to return to weighing mode.

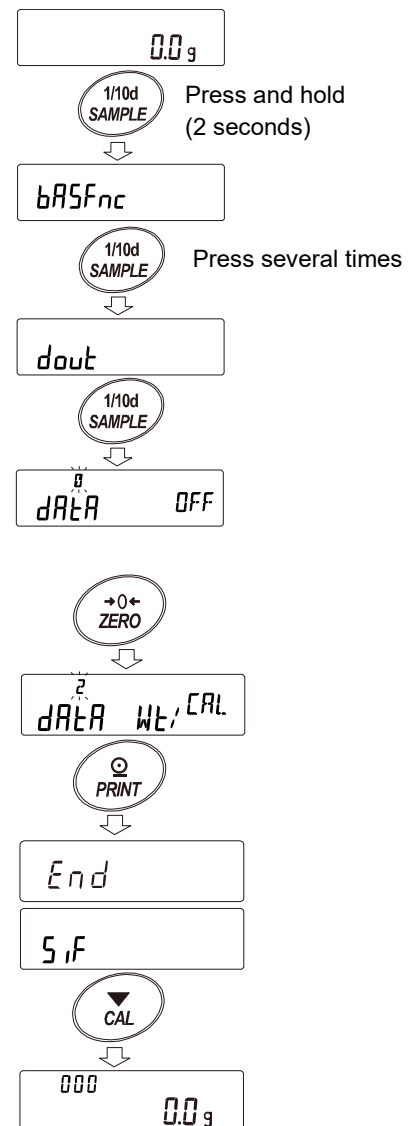

Display and symbol

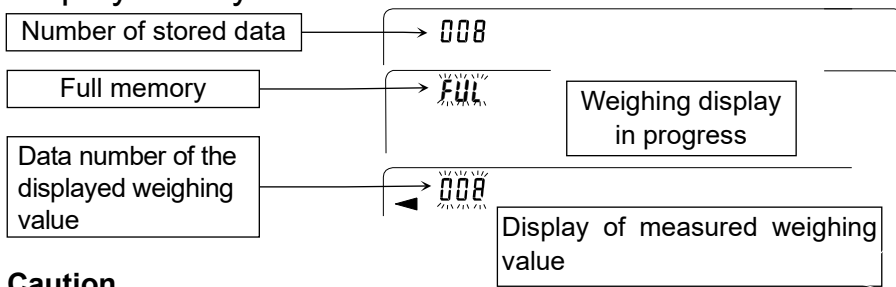

When the volume of weighing values stored reaches its maximum, **FUL** ↔ **dAt** blink in turn.

Caution

- ❑ When weighing data is being stored in memory, the data is output simultaneously using RS-232C or USB interface.
- ❑ " **FUL** " indicates that memory is full or the memory capacity has been reached. More data cannot be stored unless the stored data is deleted.
- ❑ When the interval output mode is operating, automatic sensitivity adjustment due to temperature change is not performed.
- ❑ The statistical calculation function cannot be used while the data memory function is being used.

Setting the function table

Parameter settings for each output mode are as follows:

Mode \ Item	Data output mode	Auto print polarity, difference	Data memory function	Interval time
Key mode	<i>Pr</i> t 0	Not used	<i>dAt</i> A 2	Not used
Auto print mode A	<i>Pr</i> t 1	<i>AP-A</i> 0 to 2	<i>dAt</i> A 2	
Auto print mode B	<i>Pr</i> t 2	<i>AP-b</i> 0 to 2	<i>dAt</i> A 2	
Key mode B (immediate)	<i>Pr</i> t 4	Not used	<i>dAt</i> A 2	
Key mode C (stable)	<i>Pr</i> t 5		<i>dAt</i> A 2	
Interval output mode	<i>Pr</i> t 6		<i>dAt</i> A 2	
Auto print mode C	<i>Pr</i> t 7		<i>dAt</i> A 2	Not used

Parameter settings for data number, ID number, Time/Date

Data number	No	<i>d-na</i> 0	Time/Date	No	<i>S-td</i> 0	Up to 200 sets can be stored.
	Yes	<i>d-na</i> 1		Time only	<i>S-td</i> 1	
ID number	No	<i>S-id</i> 0		Date only	<i>S-td</i> 2	
	Yes	<i>S-id</i> 1		Both	<i>S-td</i> 3	

Displaying the stored weighing results

Note

- Confirm that the "Data memory (dAtA)" parameter is set to "Stores the weighing data and sensitivity adjustment history (dAtA 2)".

1. Press and hold the **PRINT** key (for 2 seconds) to display **RECALL**.

2. Press the **PRINT** key to enter the memory recall mode.
-d- or **d-t** [types of weighing results] appears in the upper left of the display. Operate the following keys.

ZERO key Displays the next data set.

MODE key Displays the previous data set.

PRINT key Outputs the displayed data via RS-232C or USB.

CAL key Exits the memory recall mode.

3. Press the **CAL** key to return to weighing mode.

Note The time and date output settings can be changed after the weighing values are stored.

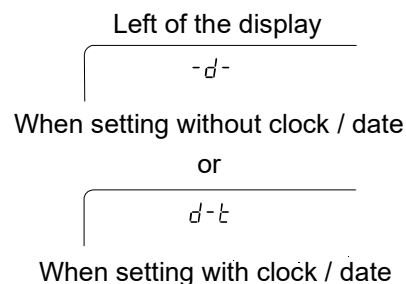

Outputting stored weighing results in batch

Caution

- In order to output in batch, "Serial interface (S, F)" of the function table must be configured. Refer to "9. Function Table" and "21. Connecting Peripheral Devices".

1. Press and hold the **PRINT** key for 2 seconds to display **RECALL**.

2. Press the **SAMPLE** key to display **out**.

3. Press the **PRINT** key to display **out No** with "No" blinking.

4. Press the **ZERO** key to display **out Go** with "Go" blinking.

5. Press the **PRINT** key to output the stored data all at once via RS-232C/USB.

6. The balance displays **CLEAR** when the output is completed. Press the **CAL** key to return to weighing mode.

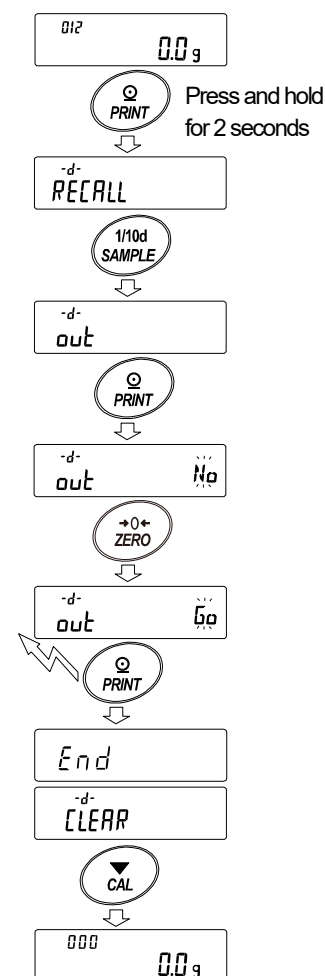

Deleting the stored weighing results in batch

1. Press and hold the **PRINT** key for 2 seconds to display **RECALL**.
2. Press the **SAMPLE** key several times to display **CLEAR**.
3. Press the **PRINT** key to display **CLEAR No** with "No" blinking.
4. Press the **ZERO** key to display **CLEAR Go** with "Go" blinking.
5. Press the **PRINT** key to delete all the stored data.
6. The balance displays **End** when the deletion is completed, then returns to weighing mode.

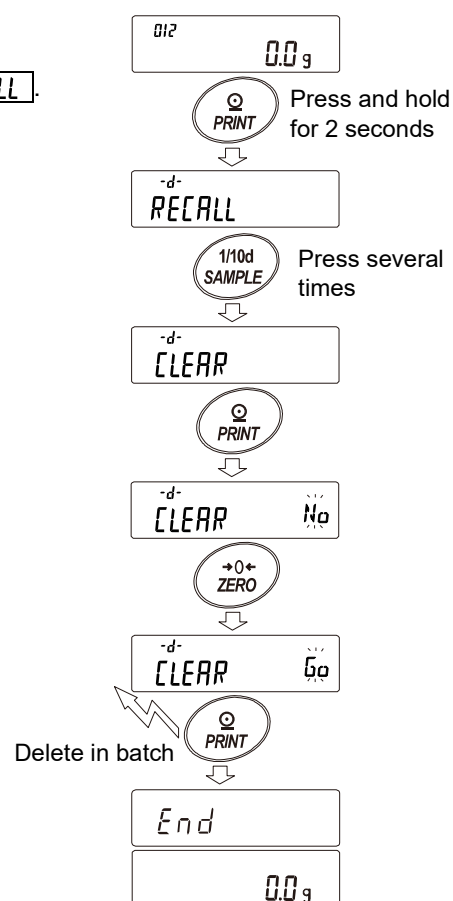

11-2. Data memory for sensitivity adjustment and calibration test

Features

- The results of sensitivity adjustment (with the internal weight/an external weight) results and calibration test results can be stored in the internal memory of the balance.
- The stored results can be output (to an optional printer or personal computer) in batch.
- The balance has a capacity to store up to 50 sensitivity adjustment /calibration test results.

Note When the memory capacity of up to 50 sets has been reached, **FULL** ↔ **CAL** indicators blink in turn.

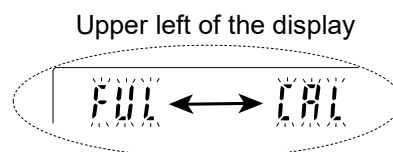

Storing the sensitivity adjustment and calibration test results

1. Set the "Data memory (**DATA**)" parameter to "Stores weighing data and sensitivity adjustment history (**DATA 2**)". Refer to "9. Function Table".
2. With the settings above, each time sensitivity adjustment or calibration test is performed, the data is stored automatically.

Outputting sensitivity adjustment history

- In weighing mode, press and hold the **CAL** key for 2 seconds. When **CAL H,5** is displayed, release your finger from the key. **out** appears. If there is no sensitivity adjustment history, **No dAtA** is displayed, then the display returns to weighing mode.
- Press the **PRINT** key to display **out No**.
- Switch **No** / **Go** with the **ZERO** key to display **out Go**.
- With **out Go** displayed, press the **PRINT** key to start output in batch. The output format is compliant with "10-3. GLP report".
- When output is completed, **End** is displayed, and then **CLEAR** appears.
- To delete saved histories all at once, proceed to following "[Deleting sensitivity adjustment history](#)". To return to the weighing value, press the **CAL** key.

Note If the **FUL** ↔ **CAL** indicators are blinking in turn with weighing display, 50 sets of data have been already stored in memory. If a new result is saved in this state, the oldest data will be overwritten. Delete some of the saved data.

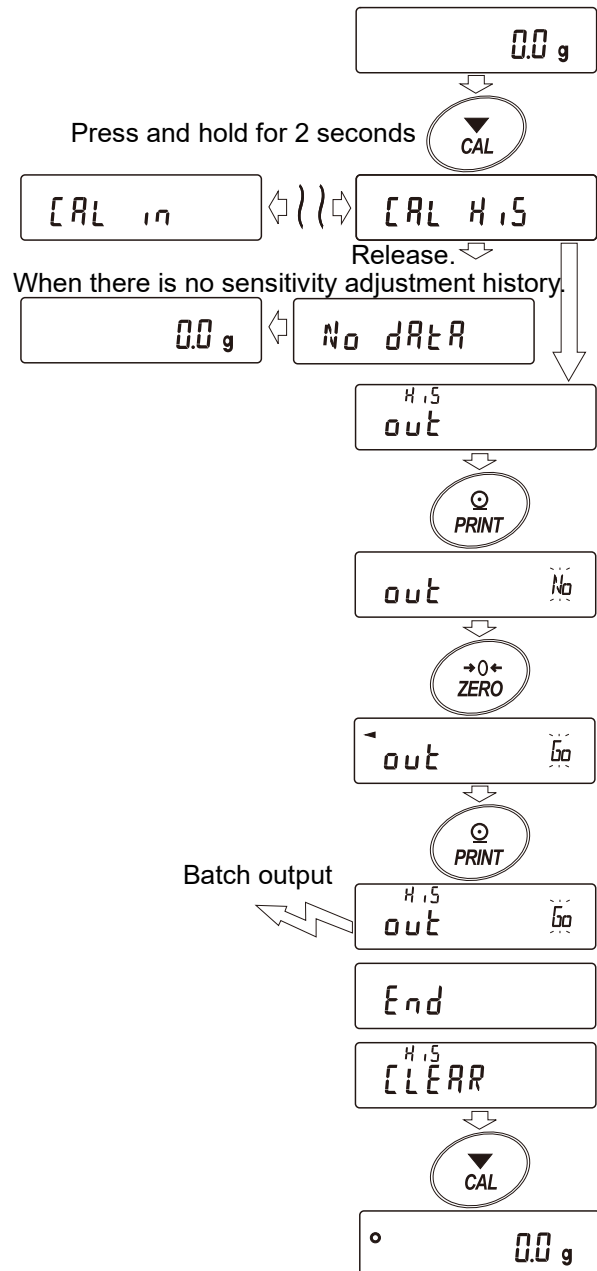

Deleting sensitivity adjustment history

1. Press and hold the **CAL** key for 2 seconds.
When **CAL H.5** is displayed, release the key.
out appears.
2. Press the **SAMPLE** key to display **CLEAR**.
3. Press the **PRINT** key to display **CLEAR No**.
4. Press the **ZERO** key to toggle between **No** / **Go** to display **CLEAR Go**.
5. With **CLEAR Go** displayed, press the **PRINT** key to start deleting all at once.
6. When deletion is completed, the balance displays **End** and returns to weighing mode.

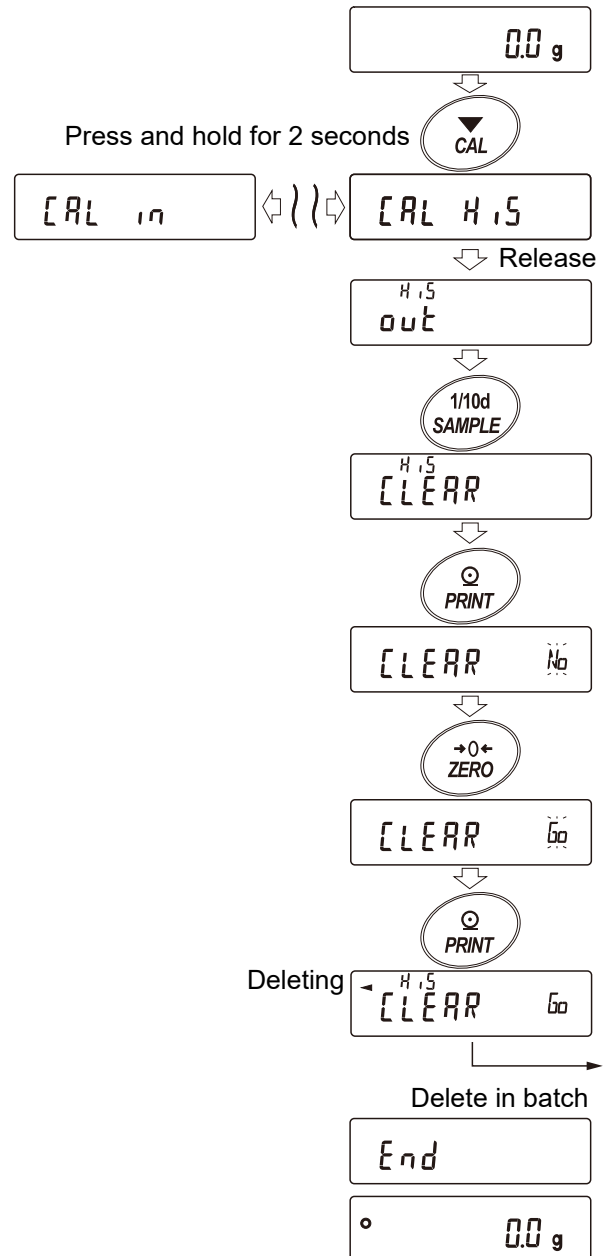

11-3. Data memory for “unit weight” in the counting mode

Features

- ❑ Up to 50 unit weights can be stored for “unit weight” in the counting mode.
P01 is the first unit weight data, and it is the standard memory in normal counting mode. 49 additional unit weights can be stored.
- ❑ The stored unit weight is stored in nonvolatile memory even if the power is removed.
- ❑ By reading the stored unit weight, the counting operation can be performed without registering the unit weight each time.
- ❑ The read unit weight can be changed in “Weighing input mode” (method of registering the unit weight by placing a specified number of samples) or “Digital input mode” (method of inputting the unit weight digitally).

(1) Registering unit weight data

To register (store) a new unit weight, first read the unit weight data to be changed. Then, the read data can be changed and registered (stored) in “Weighing input mode” or “Digital input mode”. The registration (changeable) range for unit weight data is *P01* to *P50*.

1. Set “Data memory (*dAtA*)” in the function table to “1”. (Refer to “9. Function Table”.)
2. Press the **MODE** key to select **PCS** (counting mode).

Caution

If not displayed, register the unit **PCS** in the function table.

3. Press the **PRINT** key for 2 seconds to enter confirmation mode.
The unit weight data (the unit weight number and blinking display of unit weight value) is read. The latest unit weight data selected or registered is displayed.

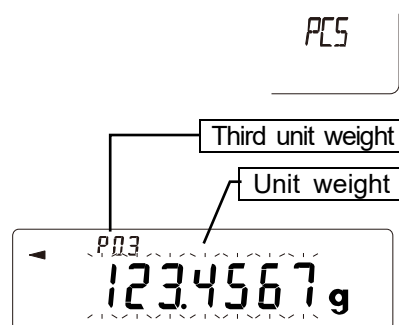

4. Use the following keys to select the unit weight number to use.
ZERO key Increases the unit weight number by one.
MODE key Decreases the unit weight number by one.

Changing (registering) the selected (read) unit weight data

- ❑ To change by weighing input, press the **SAMPLE** key to proceed to “Weighing input mode”.
- ❑ To change by digital input, press the **SAMPLE** key and hold down the **MODE** key to proceed to “Digital input mode”.

Caution

- ❑ ACAI cannot be applied to the read unit weight.

Note

- ❑ The unit weight can be read with the “UN:mm command. (mm: 01 to 50)
- ❑ The read unit weight can be output with the “?UW” command
- ❑ The unit weight can be changed with the “UW:” command.

Weighing input mode

Weighing input mode is a mode in which the specified number of samples are placed on the weighing pan and the unit weight is registered.

In weighing input mode, you can use ACAI after registering the unit weight. Refer to “4-3. Counting mode (PCS)”. Register the actual weight using the following keys.

Register the actual weight using the following keys.

ZERO key Sets the display to zero. **10 - pcs** → **10 0 pcs**

TARE key When a tare is placed, sets the display to zero. **10 - pcs** → **10 0 pcs**

SAMPLE key Changes the number of samples used for registration. **10 0 pcs** → **25 0 pcs**
→ ...

PRINT key Pressing the **PRINT** key when the samples are placed registers (stores) the unit weight in data memory, then returns to the same state as step 3. For details on how to register the unit weight, refer to “4-3. Counting mode (PCS)”.

CAL key Returns to the same state as step 3 in “(1) Registering unit weight data”.

MODE key To enter “digital input mode”, press and hold the **MODE** key for 2 seconds.

Digital input mode

Digital input mode is a mode in which the unit weight of a sample is input digitally (as a numerical value) when the unit weight of the sample (weight of one sample) is known in advance. In digital input mode, the digit to change blinks.

Caution

- In digital input mode, ACAI cannot be applied after registering the unit weight. Refer to “4-3. Counting mode (PCS)”.
- The last two digits of the readability can be registered. Any digits below that will be rounded down.

Perform digital input using the following keys.

- [SAMPLE]** key..... Changes the setting digit.
- [ZERO]** key Changes the setting value.
- [MODE]** key Changes the position of the decimal separator.
- [PRINT]** key..... Registers (stores) the unit weight in data memory and then returns to the same state as step 3.
- [CAL]** key Returns to the same state as step 3 in “(1) Registering unit weight data”.
- [MODE]** key To enter “weighing input mode”, press and hold the **[MODE]** key for 2 seconds.

Change the setting value Select the digit

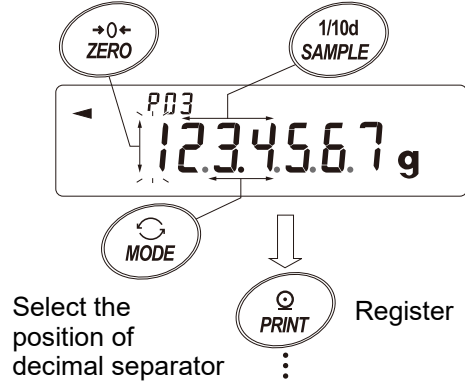

(2) Reading the unit weight data

1. Follow the steps 1, 2 and 3 of “(1) Registering unit weight data” to enter the confirmation mode.
2. Select the unit weight number to use with the following keys.
 - [ZERO]** key Increases the unit weight number by one.
 - [MODE]** key Decreases the unit weight number by one

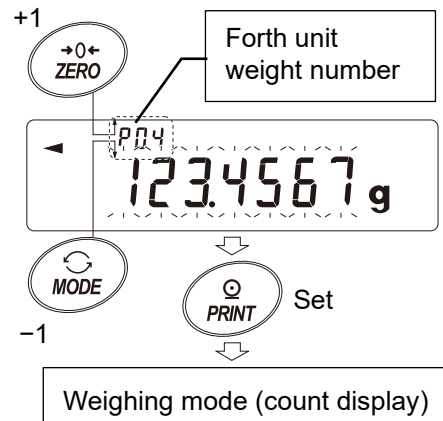

3. Press the **[PRINT]** key to set the unit weight to use. The balance returns to weighing mode (count display).

To return to weighing mode (count display) without changing the unit weight, press the **[CAL]** key.

Caution

- If the set value is less than the setting range, **[Error 2]** is displayed. For the minimum unit mass, refer to “23. Specifications”.

11-4. Data memory for comparator settings

Features

- The data memory function can store 20 sets of upper and lower limit values for the comparator mode.

Caution

- The reference value or tolerance value for the comparator mode cannot be stored in memory.
- By reading the stored upper / lower limit value, weighing can be performed without registering each time. The upper and lower limit values in memory can be recalled easily using the **MODE** key (quick selection mode).
- The upper and lower limit values in memory can be recalled and changed.
- The read upper / lower limit value can be changed in "Weighing input mode" (method of registering the value by placing a sample) or "Digital input mode" (method of inputting the value digitally).

(1) Storing the upper / lower limit value data

To register (store) a new upper/lower limit value for the comparator, first read the upper/lower limit data to be changed (C01 to C20). Then, the read data can be changed and registered (stored) in "Weighing input mode" or "Digital input mode".

Caution

While the data memory function is in use, unit selection using the **MODE** key is not available.

1. Press the **MODE** key to select a unit to be used for registration.
2. Set the "Data memory (dAtA)" parameter to "3" in the function table. Refer to "9. Function Table".
Press the **CAL** key to return to weighing mode.

3. Press and hold the **PRINT** key for 2 seconds to enter the upper and lower limit values confirmation mode. The comparator upper limit data (comparator number and upper limit weight (blinking)) is read. The upper limit value last selected is displayed.

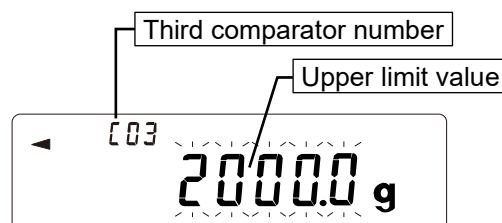

4. Select the comparator number to be used, using the following keys. (C01 to C20 can be changed.)
ZERO key Increases the comparator number by one.
MODE key Decreases the comparator number by one.

The key operation switches the number as follows: ... ⇔ C03 **HI** ⇔ C03 **LO** ⇔ C04 **HI** ⇔ C04 **LO** ⇔ ... The upper limit (HI) and lower limit (LO) switch alternately.
In 5 step comparison, the number changes as follows : ... ⇔ C03 **HI** blinking ⇔ C03 **HI** ⇔ C03 **LO** ⇔ C03 **LO** blinking ⇔ C04 **HI** blinking.

Changing (storing) the selected (read) upper / lower limit data

- To change in "Digital input mode", press the **SAMPLE** key to enter the mode.
- To change in "Weighing input mode", press the **SAMPLE** key, then press and hold the **MODE** key to enter the mode.

Note

- Using the "CN:mm" command, the upper and lower limit values can be recalled. (mm indicates a two-digit numerical value 01-20, which corresponds to C01 - C20.)

- The read upper limit value can be output with the “?HI” command, and the lower limit value can be output with the “?LO” command.
- The upper limit value can be changed with the "HI:" command, and the lower limit value can be changed with the "LO:" command.

Digital input mode

In the digital input mode, the upper and lower limit values are entered digitally using the keys. When in the digital input mode, the digit to be changed will blink.

Use the following keys to store upper and lower limit values.

- [SAMPLE]** key ... Selects the digit to be changed.
- [ZERO]** key Changes the value of the selected digit.
- [MODE]** key Changes the polarity.
- [PRINT]** key Stores the upper and lower limit values.
- [CAL]** key Returns to the same status as step 3 in “(1) Storing the upper / lower limit value data”.
- [MODE]** key Press and hold for 2 seconds to move to “Weighing input mode”.

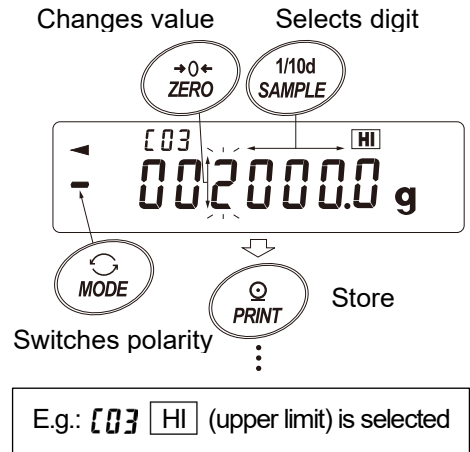

Weighing input mode

In the weighing input mode, a sample corresponding to the upper/lower limit is placed on the weighing pan to store the upper/lower limit value.

Note

- Pressing the **[CAL]** key will interrupt the operation and the balance will save the set values up to that point and return to the same status as step 3 in “(1) Storing the upper / lower limit value data”.
- To move to the digital input mode, press and hold the **[MODE]** key for 2 seconds.

When the balance enters the weighing input mode, **[HI]** on the display illuminates and the stored comparator number and the current weight value are displayed.

The figure on the right is an example of the display when **03** **[HI]** (upper limit) is selected.

For the second upper limit, **[HI]** blinks.

- Place a container on the weighing pan, if necessary. Press the **[ZERO]** key to set the display to zero.
- Place a sample corresponding to the upper limit value on the weighing pan or in the container.
- Press the **[PRINT]** key to store the upper limit value. Remove the sample from the weighing pan. The comparator upper limit is registered (stored) in the **03** data memory.

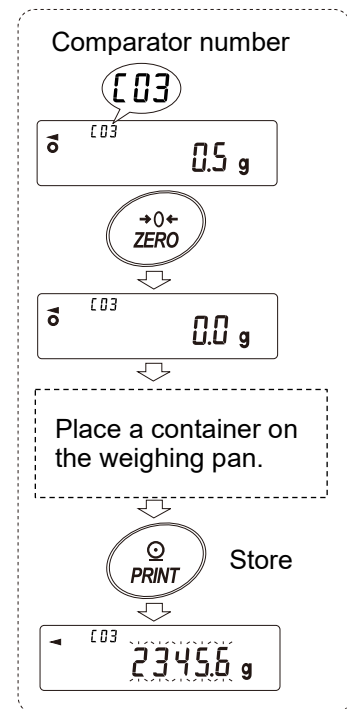

(2) Reading the upper / lower limit value data (Quick selection mode)

This is a simple way to read the comparator upper / lower limit value data stored in the memory. With this operation, the stored data can be quickly read and used.

Note

To register (store) the upper and lower limit values, refer to “(1) Storing the upper / lower limit value data”.

Caution

Confirm that the item "Data memory function (*dAtA*)" is set to "3" in the function table.

1. Press the **MODE** key to enter the quick selection mode.

When the balance enters the quick selection mode, comparator upper limit value blinks and comparator number is displayed. The last selected value is displayed.

2. Press the **MODE** key to select the value. The value changes as follows: **03** **HI** ⇒ **03** **LO** ⇒ **03** **HI** ⇒ **03** **LO** ⇒...

Pressing the **PRINT** key at the desired setting value (e.g., the setting value of **03** as shown in the figure on the right) sets the value and returns to weighing display. The comparator upper and lower limit values of **03** can be used for weighing.

Caution

Pressing the **CAL** key returns the balance to weighing mode without setting anything.

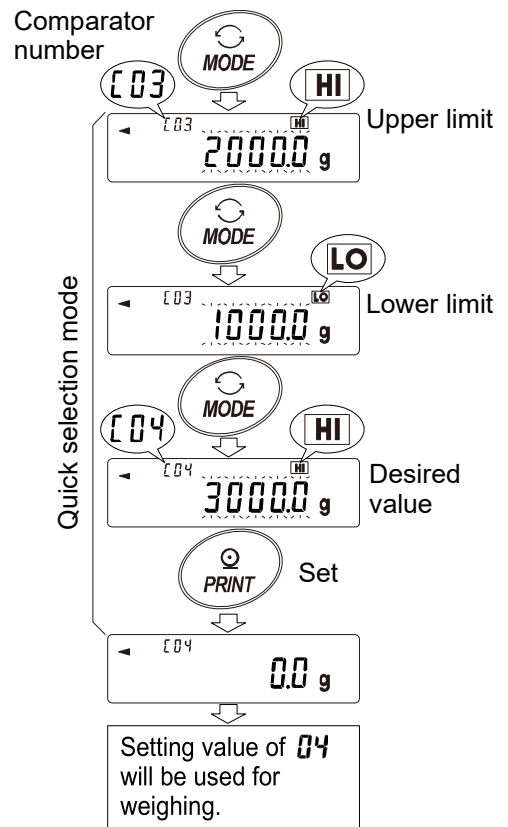

11-5. Data memory for tare value

Features

- The data memory function can store up to 20 sets of tare value for weighing.
- By reading the stored tare value, weighing can be performed without registering each time.
Can be recalled easily using the **MODE** key (quick selection mode).
- The tare value stored in the memory can be recalled and changed.
- Cannot be used in counting mode or percent mode.

Note

- The read tare value can be changed in "Weighing input mode" (method of registering the tare value by placing a container) or "Digital input mode" (method of inputting the tare value digitally).
- The "NET" mark lights up during tare operation.

(1) Storing tare value data

To register (store) a new tare value, first read the tare value data to be changed ($t01$ to $t20$). Then, the read data can be changed in "Weighing input mode" or "Digital input mode".

Caution

- When the **ZERO** key is pressed with nothing placed on the weighing pan, zero is displayed, The "NET" mark does not illuminate.
- "t--" appears when a tare operation is performed without using the tare value stored in memory.
- While the data memory function is in use, unit selection using the **MODE** key is not available.

1. Press the **MODE** key to select a unit to be used for storage.
2. Set the "Data memory ($dAtA$)" parameter to " 4 ". (Refer to "9. Function Table")
Press the **CAL** key to return to weighing mode.

3. Press and hold the **PRINT** key for 2 seconds to enter the tare value confirmation mode. Tare value data (tare value number and tare value (blinking)) is read out.

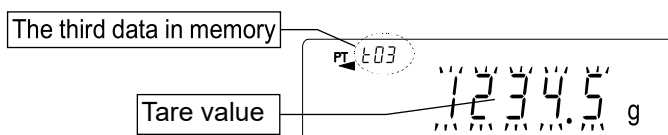

The tare value last selected or stored is displayed.

4. Select the tare number to be used, using the following keys.

- ZERO** key Increases the tare number by one.
- MODE** key Decreases the tare number by one.
- CAL** key Returns the balance to weighing mode without changing the data.

The changeable range is from $t01$ to $t20$.
The key operation switches the number as follows:
... ⇔ $t03$ ⇔ $t04$ ⇔ ... ⇔ $t20$ ⇔ $t01$ ⇔ ...

Changing the selected (read) tare value data

- To change in “Weighing input mode”, press the **SAMPLE** key to enter the mode.
- To change in “Digital input mode”, press the **SAMPLE** key, then press and hold the **MODE** key to enter the mode.

Note

- The tare value can be read by using the “PN:mm” command. “mm” ranges from 01 to 20, corresponding to $t01$ to $t20$.
- The read tare value can be output by using the “?PT” command
- The tare value can be changed by using the “PT:” command.

Weighing input mode

In the weighing input mode, a sample tare container is placed on the weighing pan to store the tare value.

Caution

Pressing the **CAL** key will interrupt the operation and the balance will return to the same state as step 3 in “(1) Storing the tare value data”.

To enter "Digital input mode", press and hold the **MODE** key.

1. When the balance enters the weighing input mode, the "PT" mark blinks and the tare value number and current weight value are displayed.
2. Press the **ZERO** key to set the display to zero.
3. Place the container on the weighing pan.
4. Press the **PRINT** key to store the tare value. The tare value is registered (stored) in the $t03$ data memory.

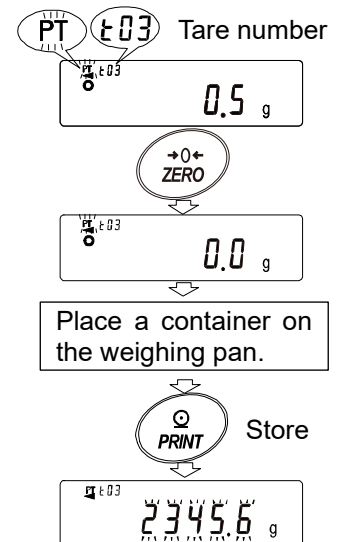

Digital input mode

In the digital input mode, the tare value (numerical value) is input digitally. When in the digital input mode, the digit to be changed will blink.

Use the following keys to store the value:

- SAMPLE** key..... Changes the setting digit.
- ZERO** key Changes the setting value.
- PRINT** key..... Registers (stores) the tare value in data memory.
- CAL** key..... Returns the balance to the same state as step 3 in “(1) Storing the tare value data”.
- MODE** key..... To enter “Weighing input mode”, press and hold the **MODE** key for 2 seconds.

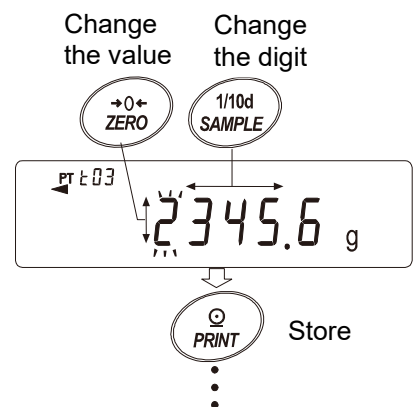

(2) Reading the tare value (Quick selection mode)

This is a simple way to read the tare value stored in the memory. With this operation, the stored data can be quickly read and used.

Note

To register (store) tare value data, refer to "(1) Storing the tare value data".

Caution

Confirm that the item "dRtR)" is set to "4" in the function table.

1. Press the **MODE** key to enter the quick selection mode.
2. When the balance enters the quick selection mode, the "PT" mark blinks and the tare value number and current weight value are displayed. The value last selected is displayed.
3. Press the **MODE** key to select the value. The value changes as follows: $t03 \Rightarrow t03 \Rightarrow t05 \Rightarrow \dots \Rightarrow t01 \Rightarrow t01 \Rightarrow$
4. Pressing the **PRINT** key at the desired setting value (e.g., the setting value of $t03$ as shown in the figure on the right) sets the value and displays weighing display. The set value of $t03$ can be used for weighing.

Caution

Pressing the **CAL** key returns the balance to weighing mode without setting anything.

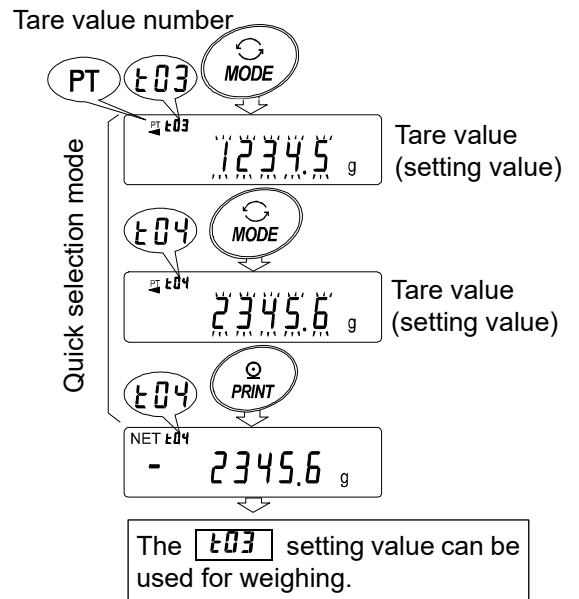

Canceling the tare value data

To cancel the tare value data, remove everything from the weighing pan and press the **ZERO** key.

The read tare value is canceled.

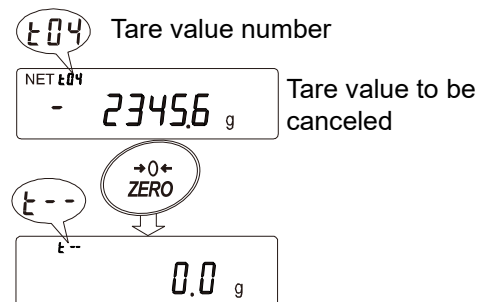

11-6. Data memory: Quick selection mode

The data memory has "quick selection mode" to quickly read the data stored in the data memory. The main features are as follows:

Features

- The setting values stored in the data memory can be easily read using only the **MODE** key.
- In this mode, two types of data can be read out: "tare value memory" and "comparator memory".

Caution

Unit selection using the **MODE** key is not possible while data memory is in use.

Only the data memory set (selected) in the function table can be read in this mode.

How to operate

1. Press the **MODE** key to enter the quick selection mode. When the balance enters the mode, the set value will blink. The latest value selected is displayed.
2. Press the **MODE** key to select the value. (Each press advances the value by one.)

When tare value data is set for data memory

The set value and tare value number are displayed. Pressing the **MODE** key changes the number as follows: ... **t03** ⇒ **t03** ⇒ **t05** ⇒ ... ⇒ **t01** ⇒ **t01** ⇒ ...

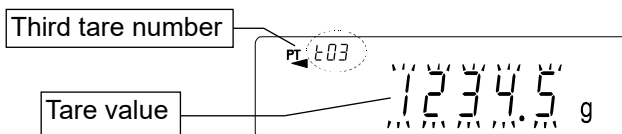

When comparator data is set for data memory

The set value and comparator number are displayed. Pressing the **MODE** key changes the number as follows:

... **003 HI** ⇒ **003 LO** ⇒ **003 HI** ⇒ **003 LO** ⇒ ... ⇒ **020 HI** ⇒ **020 LO** ⇒ **001 HI** ⇒ ...

The comparator upper limit value (**HI**) and lower limit value (**LO**) switch alternately.

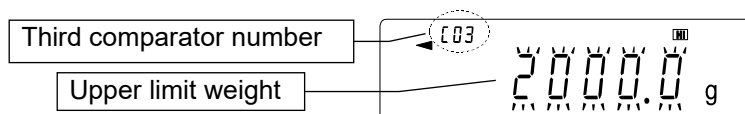

3. Press the **PRINT** key (or wait) at the desired set value to set the value and return to weighing mode. The read set value can be used for weighing.

Caution

Pressing the **CAL** returns the balance to weighing mode without setting anything.

11-7. Data memory: Selection/confirmation/storage mode

In “selection/confirmation/storage mode”, the setting values stored in the data memory can be read, checked or used, or the read values can be changed and registered. Unlike “quick selection mode”, the read set values can be changed. The following three types of data can be operated in “selection/confirmation/storage mode”.

- ❑ Unit weight memory data
- ❑ Tare value memory data
- ❑ Comparator memory data

Caution

- ❑ Only the data memory set (selected) in the function table can be read or changed in this mode.
- ❑ To operate other data memory that is not set (selected) in the function table, change the settings of the "Data Memory Function (dAtA)" in the function table. (Refer to “9. Function Table”)

How to operate

1. Press and hold the **PRINT** key for 2 seconds to enter the selection/confirmation mode and the set value blinks. The set value last selected is displayed.
2. Press the **ZERO** key (to increase the value by 1) or the **MODE** key (to decrease the value by 1) to select the set value.

When unit weight data is set for data memory

The set value and unit weight number are displayed. The set value changes by key operation as follows:

... P03 ⇄ P04 ⇄ P05 ⇄ ... ⇄ P50 ⇄ P01 ⇄ ...

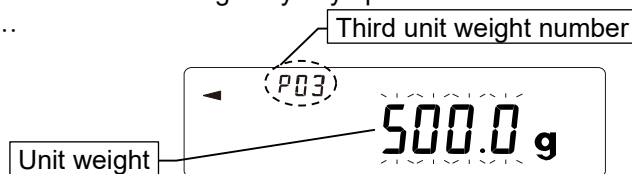

When tare value data is set for data memory

The set value and tare value number are displayed. The set value changes by key operation as follows:

... t03 ⇄ t03 ⇄ t05 ⇄ ... ⇄ t01 ⇄ t01 ⇄ ...

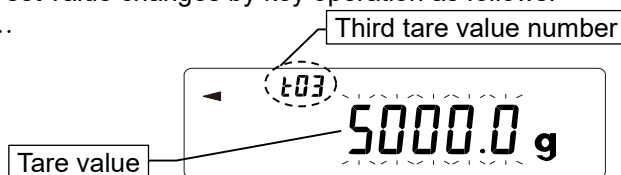

When comparator data is set for data memory

The set value and comparator number are displayed. The set value changes by key operation as follows:

... [03] [HI] ⇄ [03] [LO] ⇄ [03] [HI] ⇄ [03] [LO] ⇄ ... ⇄ [20] [HI] ⇄ [20] [LO] ⇄ [01] [HI] ⇄ ...

The comparator upper limit value ([HI]) and lower limit value ([LO]) switch alternately.

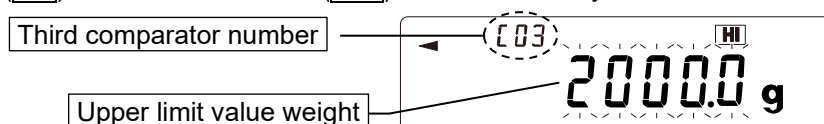

3. Select “Changing the set value” or “Using the set value for weighing”.

Using the selected (read) set value for weighing

Press the **PRINT** key at the desired set value to set the value and return to weighing mode.

Changing (storing) the selected (read) set value

Press the **SAMPLE** key to enter the storage mode. Two inputting modes are available for entering the setting value to be stored:

- Digital input mode (digital input of set values by key operation)
- Weighing input mode (input of set values by placing a sample)

Caution

- To switch the modes, press and hold the **MODE** key for 2 seconds.
- To cancel the operation and return to weighing mode without any change, press the **CAL** key.
- For details, refer to the description of each usage.

12. Statistical Calculation Mode

The statistical calculation mode statistically calculates the weight data, and displays or outputs the results. To use the statistical calculation mode, set the "Application function (APF)" parameter of "Application (AP Fnc)" to "2" in the function table, as described below. To return to the normal weighing mode (factory setting), set "Application mode (APF)" to "0".

Statistical items available are number of data, sum, maximum, minimum, range (maximum - minimum), average, standard deviation, coefficient of variation, and relative error. What statistical items to output can be selected from the four modes in "Statistical function mode output items (SEPF)" of Application Function (AP Fnc) in the function table.

- Incorrect data input can be canceled by key operation if it is immediately after the input.
- Turning the balance off will delete the statistical data.
- The standard deviation, coefficient of variation, and relative error are obtained by the equation below:

$$\text{Standard deviation} = \sqrt{\frac{N \cdot \sum(X_i)^2 - (\sum X_i)^2}{N \cdot (N-1)}} \text{ where } X_i \text{ is the } i\text{-th weight data, } N \text{ is number of data.}$$

$$\text{Coefficient of variation (CV)} = \frac{\text{Standard deviation}}{\text{Average}} \times 100 (\%)$$

$$\text{Relative error of maximum value (MAX\%)} = \frac{\text{Maximum value} - \text{Average}}{\text{Average}} \times 100 (\%)$$

$$\text{Relative error of minimum value (MIN\%)} = \frac{\text{Minimum value} - \text{Average}}{\text{Average}} \times 100 (\%)$$

Caution

- When there is data with a readability digit off, the calculation result is displayed with the readability digit off. (Readability digit is rounded off.)
- When the data memory function is in use, the statistical calculation function cannot be used.
- When registering the warning function of the minimum weight, the statistical calculation function cannot be used.
- If the total is more than the digits, it will not be displayed correctly.

12-1. How to use the statistical calculation: Preparation

Switching to the statistical function mode (Changing the function table)

1. Press and hold the **SAMPLE** key for 2 seconds to display **bRSFnC**.
2. Press the **SAMPLE** key several times to display **APFnC**.
3. Press the **PRINT** key to display **°APF Norm**.

Press the **ZERO** key several times to display

APF² Stat.

To select statistical items to output, proceed to step 5.

To store the statistical function mode settings, proceed to step 7.

To disable the statistical calculation mode, press the **ZERO** key to return to **°APF Norm**.

Selecting the statistical items to output

4. Press the **SAMPLE** key to display **°StatF Sum**.
5. Press the **ZERO** key to change to the desired parameter.
In the example, the number of data, sum, maximum, minimum, range (maximum - minimum) and average are selected as the output items.

Parameter	Contents
■ 0	Number of data, sum
1	Number of data, sum, maximum, minimum, range (maximum - minimum), average
2	Number of data, sum, maximum, minimum, range (maximum - minimum), average, standard deviation, coefficient of variation
3	Number of data, sum, maximum, minimum, range (maximum - minimum), average, standard deviation, coefficient of variation, relative error of maximum value, relative error of minimum value

6. Press the **PRINT** key to store the setting.
7. Press the **CAL** key to return to weighing mode.

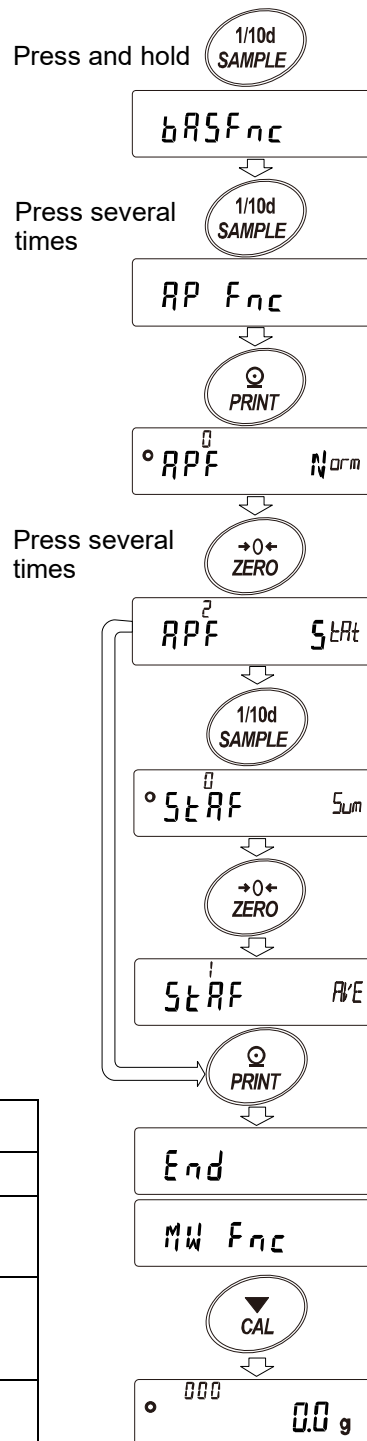

Selecting the unit

8. Press the **MODE** key to select the unit to be used for the statistical calculation mode. (In the example shown on the right, gram is selected.)

Note Selecting the unit using the **MODE** key is not available after the data is entered. In this case, clear the data as described in "[Clearing the statistical data](#)" and select the unit using the **MODE** key.

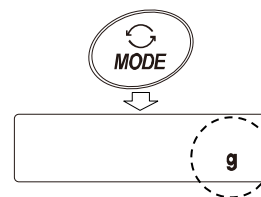

Note It is convenient to set the unit to be used in advance with "Unit (*Unit*)" in the function table if you want to enable the statistical unit function from the time the balance is turned on.

Entering data for statistical calculation

Use the following keys to operate the statistical calculation mode.

MODE key When the data is entered, changes the display contents (weighing value, statistical result and data operation) each time the key is pressed. When no data has been entered, selects the unit (mode).

SAMPLE key Turns the readability digit ON or OFF in weighing mode.

ZERO key Sets the display to zero in weighing mode.

PRINT key Outputs the data number and weight data and includes the weight data to statistical calculation in weighing mode. Output is not in the same data format as set in the function table in "[9-7. Weighing data format](#)" because of the data number added. Outputs the statistical results while the statistical results are displayed. Output is not in the same data format as set in the function table in "[9-7. Weighing data format](#)".

CAL key Returns to weighing mode after data operation and results are displayed.

1. Press the **ZERO** key to set the display to zero.
2. Place the sample on the weighing pan.
3. When the stabilization indicator turns on, press the **PRINT** key to add the data displayed to statistical calculation. The number of data on the upper left of the display increases by 1.
4. Repeat steps 1 to 3 for each weighing.

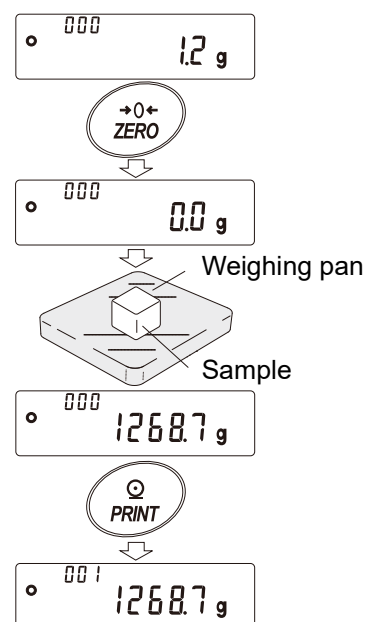

Displaying and outputting statistical results (more than one data set)

- Each time the **MODE** key is pressed, the display shows the statistical result set in “Statistical function mode output items (STAT)” followed by **CLEAR** and **CANCEL**.
Pressing the **SAMPLE** key displays the previous item.

Note

- When the number of data set is one, the coefficient of variation and relative error are displayed as **-----**.
- When the average is 0, the coefficient of variation and relative error are displayed as **-----**.
- Statistical items are indicated on the upper left of the display using the symbol.

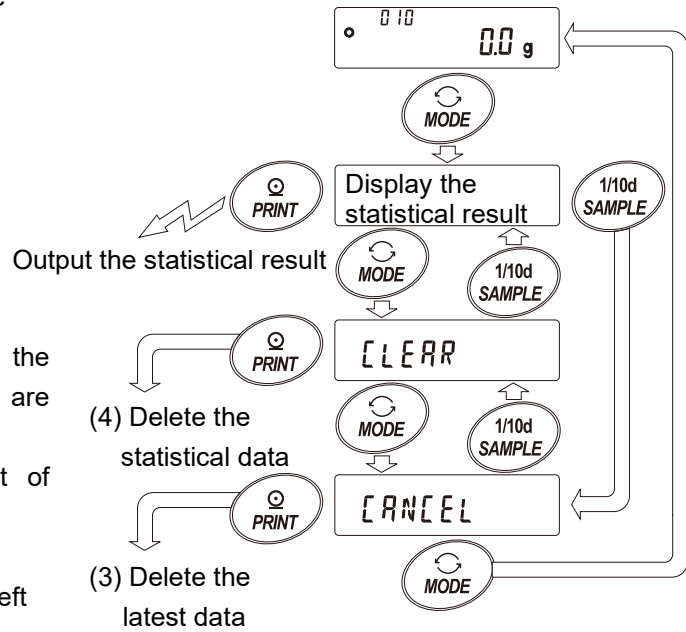

- When the statistical result is displayed, pressing the **PRINT** key outputs the statistical result.

Symbol	Statistical item
$\sum \bar{n}$	Sum
$\bar{n} \overline{R} \overline{H}$	Maximum
$\bar{n} \overline{m}$	Minimum
r	Range (maximum – minimum)
$\overline{R} \overline{U} \overline{E}$	Average
Sd	Standard deviation
Cv	Coefficient of variation
$\bar{n} \overline{R} \overline{H} \%$	Relative error of maximum value
$\bar{n} \overline{m} \%$	Relative error of minimum value

Output example

Output example (STAT)

N	10
SUM	1000.0g
MAX	105.0g
MIN	95.0g
R	10.0g
AVE	100.0g
SD	2.8g
CV	2.8%
MAX%	5.0%
MIN%	5.0%

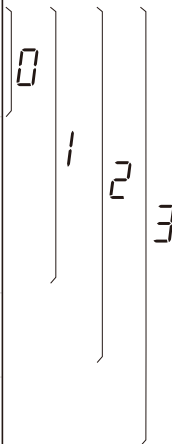

Deleting the latest data

When the wrong data is entered, it can be deleted and excluded from statistical calculation. Only the last entry will be deleted, and other previous data cannot be deleted.

1. In weighing mode, press the **MODE** key to display **CANCEL**.
2. Press the **PRINT** key to display **CANCEL No**.
3. Press the **ZERO** key to display **CANCEL 0.0**.
4. Press the **PRINT** key to delete the latest data and exclude it from statistical calculation. The number of data decreases by one when the balance returns to weighing mode.

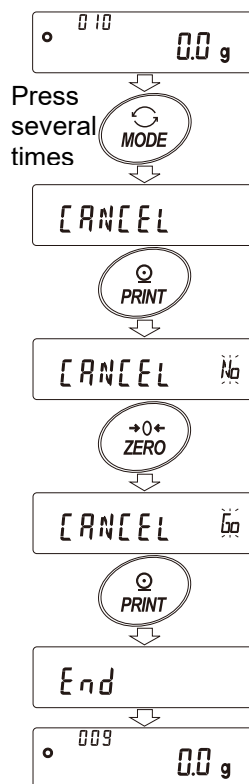

Clearing the statistical data

All the statistical data will be deleted and the number of data will be zero.

1. In weighing mode, press the **MODE** key several times to display **CLEAR**.

2. Press the **PRINT** key to display **CLEAR No**.

3. Press the **ZERO** key to display **CLEAR Go**.

4. Press the **PRINT** key to initialize the statistical data.
The data count becomes 0 (zero) when the balance returns to weighing mode.

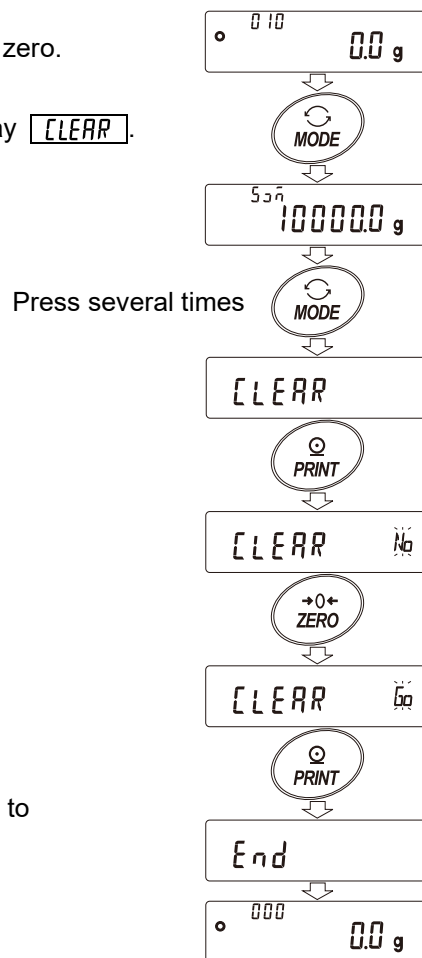

12-2. Statistical calculation mode (Example of use)

Here, as an example of use of the statistical calculation mode, mixing of formula ingredients such as chemicals is described. The mixing process is recorded using the balance and the printer.

In the example, the GX-62001L and the AD-8127 are connected using the RS-232C serial interface.

Changing the function table

- Changes
- To enable the statistical calculation mode
 - To enable “Zero after output”

Enabling the statistical calculation mode

- Enter the function table menu.
Press and hold the **SAMPLE** key for 2 seconds to display **bRSFnC**.
- Select the application function.
Press the **SAMPLE** key several times to display **HPFnC**, then press the **PRINT** key to display **°PPF Norm**.
- Change the application function parameter to “2” (Statistical calculation)
Press the **ZERO** key to display **PPF Stat**.
Press the **PRINT** key to confirm the change.
After **End** is displayed, **MWFnC** appears.

Enabling “Zero after output”

- Select “Zero after output”.
Press the **SAMPLE** key several times to display **dout**, then press the **PRINT** key to display **°Pr-t KEY**.

Press the **SAMPLE** key several times to display **°Pr-d OFF**.

- Enable “Zero after output”.
Press the **ZERO** key to display **Pr-d ON**.
Then, press the **PRINT** key to confirm the change.
After **End** is displayed, **SIF** appears.

Returning to weighing mode

- Press the **CAL** key to return to weighing mode.

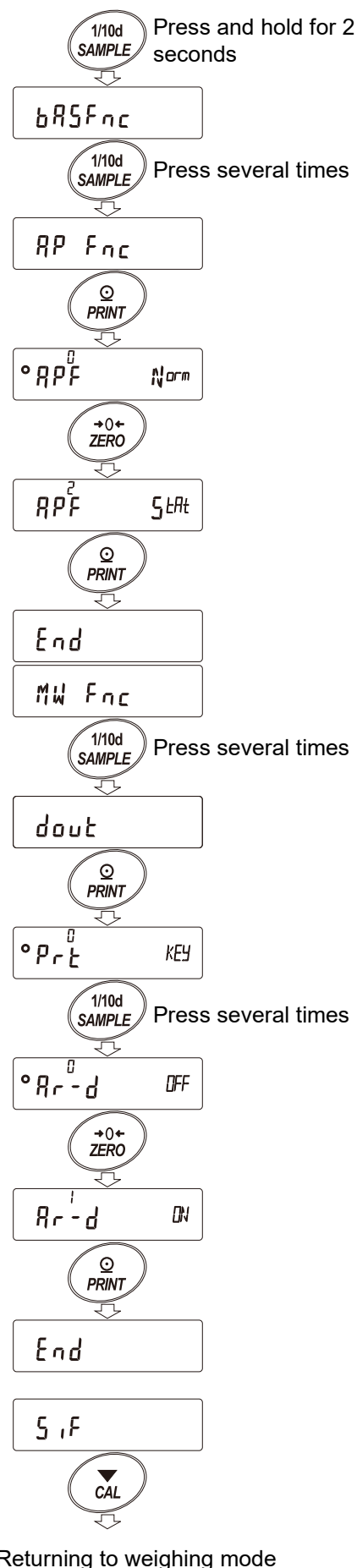

How to use the statistical calculation mode

1. Press the **ZERO** key to set the display to zero.
2. Place a container on the weighing pan, then press the **PRINT** key to store the value (registration of tare value)
The balance displays **0.0 g**
The data is output when the external output device is connected.
3. Weigh formula ingredient 1 and press the **PRINT** key. The balance displays **0.0 g**. (Storing the weight value of formula ingredient 1)
The data is output when the external output device is connected.
4. Weigh formula ingredient 2 and press the **PRINT** key. The balance displays **0.0 g**. (Storing the weight value of formula ingredient 2)
The data is output when the external output device is connected.

When there are more formula ingredients to be added, repeat step 4.

5. After mixing is completed, press the **MODE** key to display the statistical results.
6. Press the **PRINT** key to output the number of data saved including the tare value and the total weight.

Output example

No. 1		
WT,+00567.8	gTare value
No. 2		
WT,+01234.5	gFormula ingredient 1
No. 3		
WT,+01543.2	gFormula ingredient 2
N	3	
SUM	+3345.5	g
	Total weight

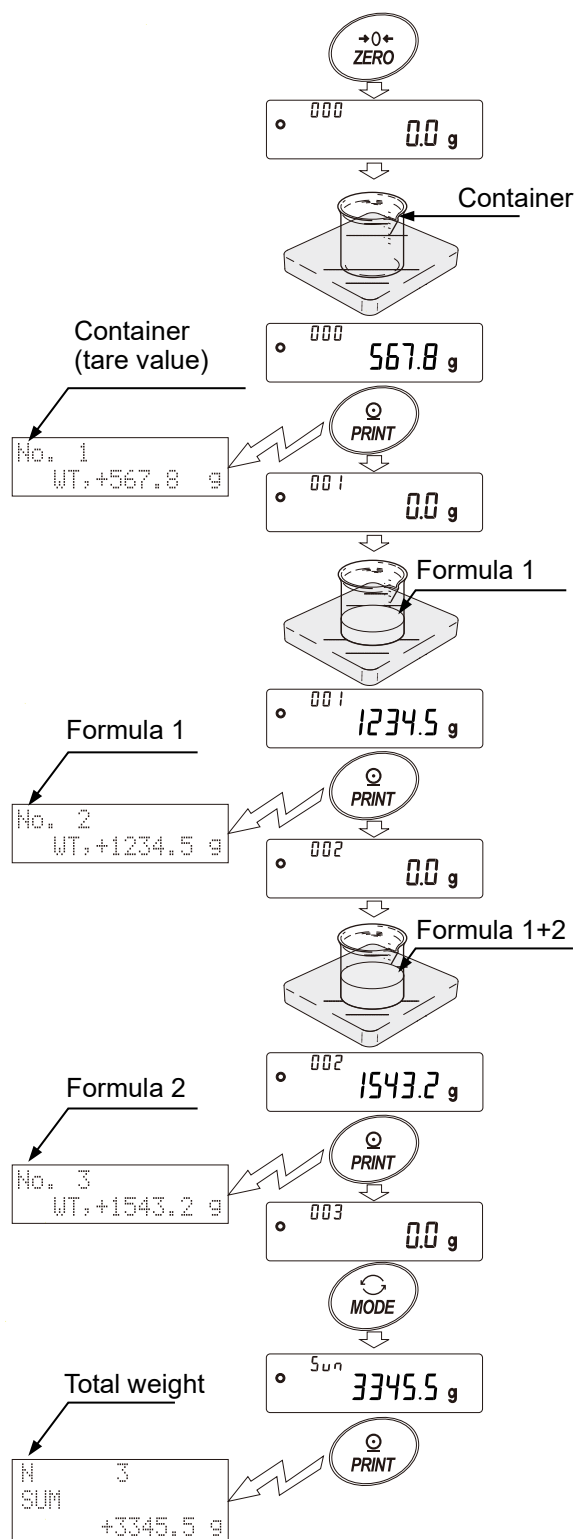

13. Flow Rate Measurement

The GX-L/GF-L series has a flow rate measurement mode to calculate the change in weighing values with time.

13-1. Overview

13-1-1. About flow rate display (FRD) function

- The balance calculates the flow rate from the weight change over time and indicates the flow rate value per unit time on its display.
- The flow rate can be calculated for both filling and discharging.
- The volume (mL) flow rate can be also calculated by setting the density of a measurement sample.

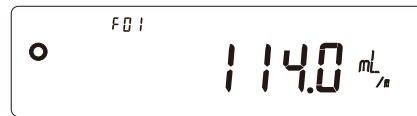

- The display switches between the weight value and the flow rate value by key operation, so the total value can be confirmed during filling or after filling.

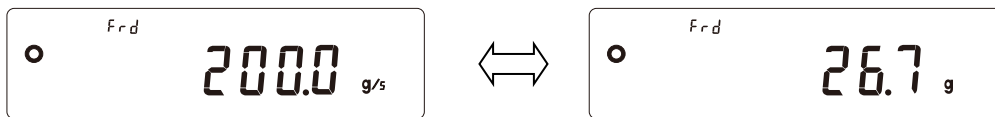

- By connecting the balance to a personal computer and using the WinCT-FRD software for Windows, the weight and flow rate values changing with time can be graphed in real-time and recorded on the PC.
- The WinCT-FRD software can be downloaded from our website: <http://www.aandd.jp/>

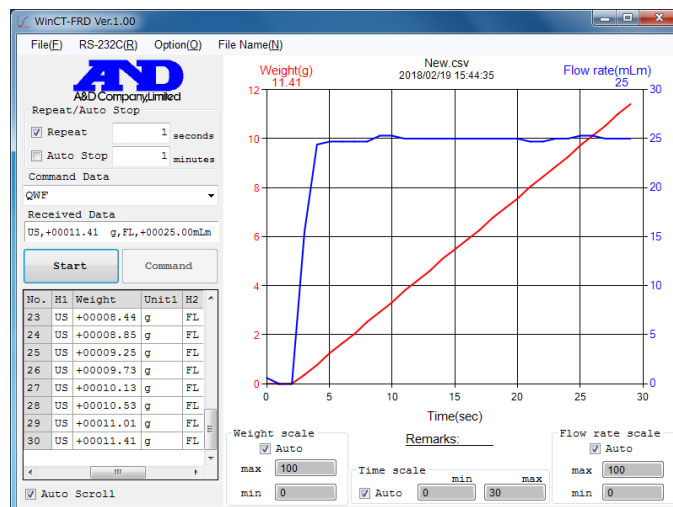

- Weighing and flow rate data can be simultaneously output to an external device.
It makes designing a device such as PLC easier when building dispensing systems and so on. In addition, it is possible to transmit a contact signal when a weight reaches the specified value by using the optional comparator output (GXL-04).

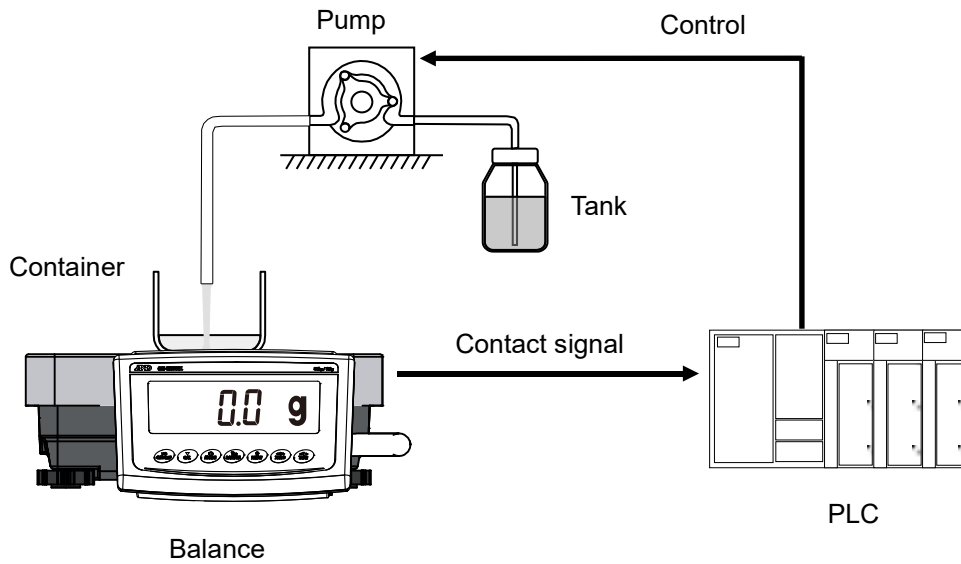

Caution

- The hold function cannot be used together.
- The tare value output function cannot be used together.

13-1-2. Flow rate calculation method

The flow rate is calculated by the following formula.

$$Q = \left| \frac{W - W'}{Ct} \right|$$

- Q: Flow rate
- Ct: Flow rate calculation time
- W: Current weight
- W': Weight before flow rate calculation time

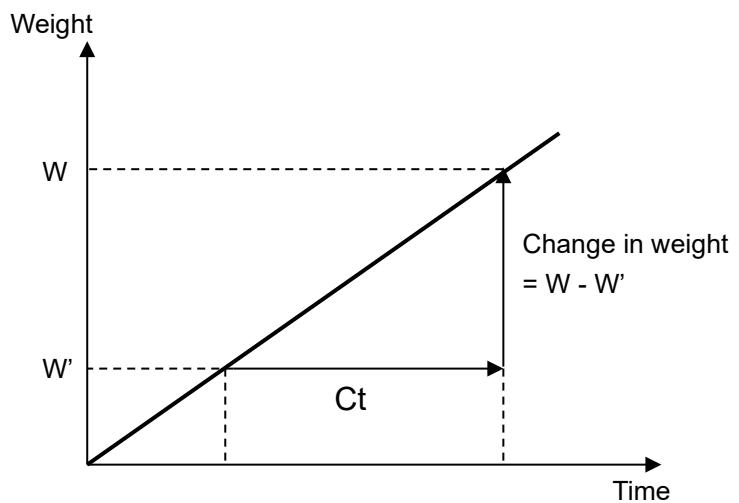

The FRD function stores the weighing data in the balance and calculates the flow rate.

- By turning off the power or pressing the **ZERO** key, the stored weighing data is initialized. After initializing the weighing data or switching to the flow rate measurement mode from the other mode, the flow rate value is displayed as "0" during the preset flow rate calculation time.
- A stable flow rate value cannot be calculated until the preset flow rate calculation time has elapsed since weighing started.
- The flow rate can be calculated in either for increasing weight (filling) or decreasing weight (discharging). Even in the case of decreasing weight, the flow rate is calculated as a positive value.

Note Variation in the calculated flow rate may change depending on the flow rate calculation time setting. Refer to "13-1-3. Examples of manual setting of flow rate calculation time (Ct)".

E.g.) When the flow rate calculation time is 1 minute.

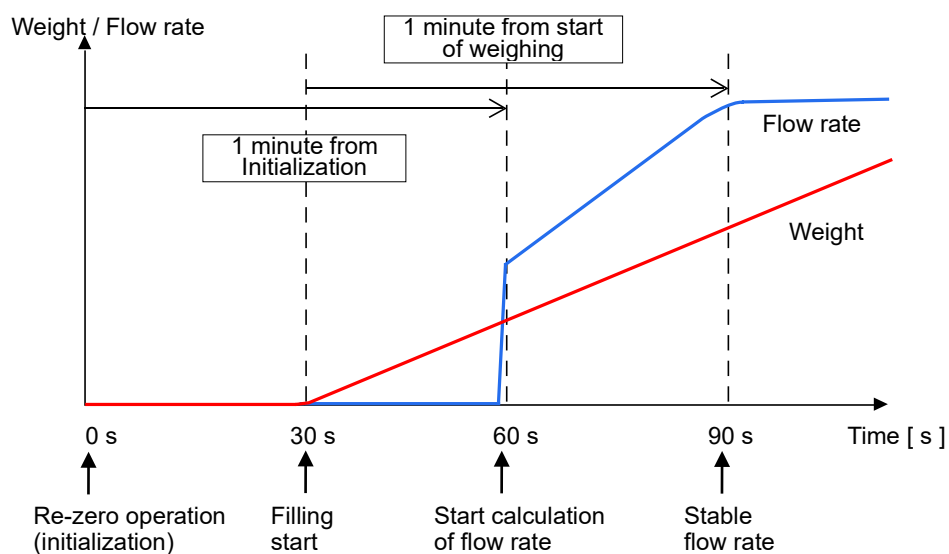

13-1-3. Examples of manual setting of flow rate calculation time (Ct)

The examples below show the affect of the flow rate calculation time setting on the flow rate value.

Inconstant flow rate

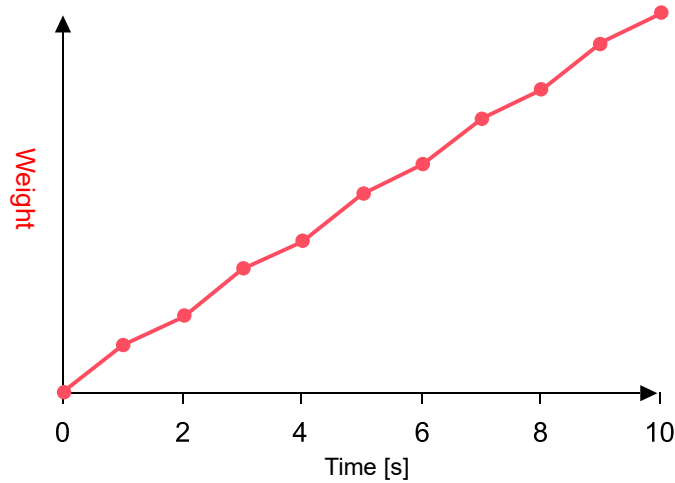

When the flow rate calculation time is 1 second:

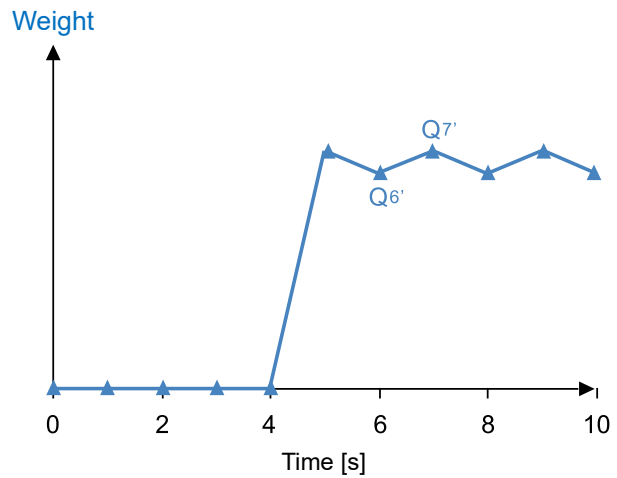
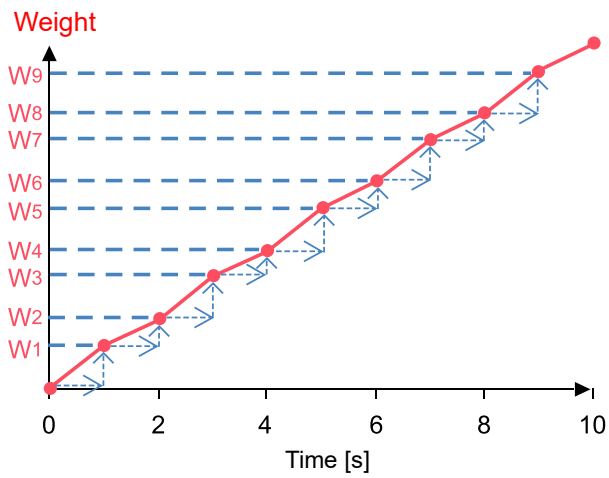

Flow rate $Q_6 = \frac{W_6 - W_5}{1}$

$Q_7 = \frac{W_7 - W_6}{1}$

In this example the 1 second change in weight is the flow rate value. Therefore, when the weighing value varies greatly, the flow rate value also fluctuates.

When the flow rate calculation time is 5 seconds:

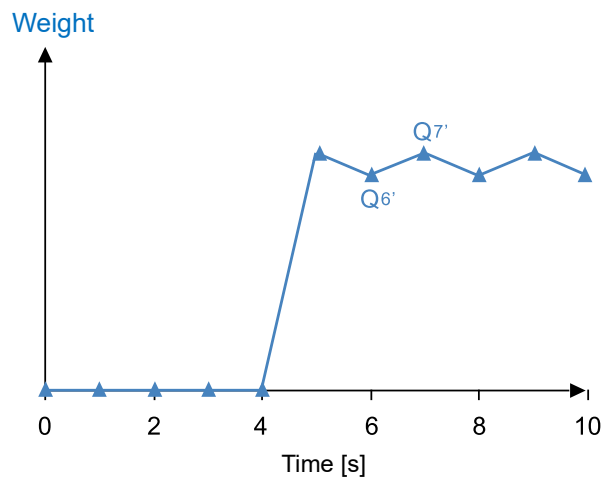
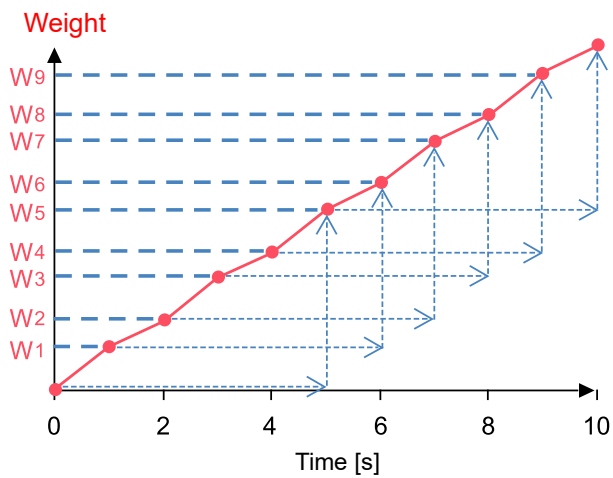

Flow rate $Q'_6 = \frac{W_6 - W_1}{5}$

$Q'_7 = \frac{W_7 - W_2}{5}$

The flow rate per second is calculated from the change in weighing value over 5 seconds.

Flow rate variation is lower compared with the 1 second flow rate calculation time.

* When the flow rate calculation time is set to 5 seconds, the flow rate is displayed as "□" for 5 seconds from the start of weighing.

13-2. How to use flow rate display (FRD) function

13-2-1. Switching to flow rate measurement mode (function table)

- When the weighing display is shown, press and hold the **SAMPLE** key for 2 seconds to display **bASFnC**.
- Press the **SAMPLE** key several times until **AP Fnc** appears.
- Press the **PRINT** key to display **APF Norm**.
- Press the **ZERO** key several times to display **APF Frd**.

To change the flow rate unit, proceed to step 5.

To store the current settings, proceed to step 10.

To cancel the flow rate function, press the **ZERO** key

several times to return to **APF Norm**.

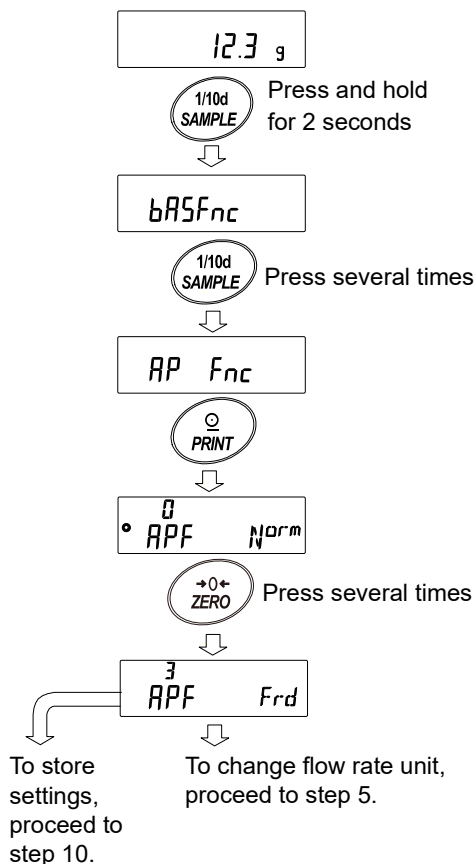

13-2-2. Changing flow rate units

By default, the flow rate unit is set to "g/s".

To change the flow rate unit, perform the following with **APF Frd** in "13-2-1. Switching to flow rate measurement mode (function table)" displayed.

- Press the **SAMPLE** key to display **Frd Unit g/s**.
- Press the **ZERO** key to change to the desired parameter.

Parameter	Description	
0	g / s (gram per second)	Mass
1	g / m (gram per minute)	
2	g / h (gram per hour)	
3	mL / s (milliliter per second)	Volume
4	mL / m (milliliter per minute)	
5	mL / h (milliliter per hour)	

■ Factory setting

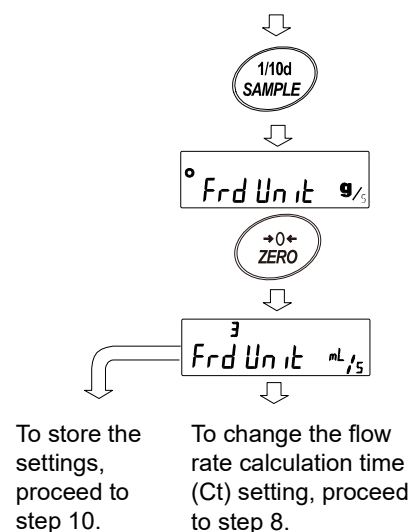

7. To change the flow rate calculation time (Ct) setting method, proceed to step 8.

To store the current settings, proceed to step 10.

If mL/s, mL/m, or mL/h is chosen, the density can be changed. The initial value is 1.0000g/cm³.

For details, refer to "13-2-4. Density input and settings".

13-2-3. Setting the flow rate calculation time (Ct)

Switching between manual/automatic settings

There are two ways to set the flow rate calculation time: automatically by the balance according to the flow rate value and manual selection of fixed values.

To switch between manual and automatic settings, perform the following operation. In the factory settings, the flow rate calculation time is set to Manual (Ct AUTO "OFF").

Proceed from step 8 below when Fr d Unit mL/s ("13-2-2. Changing flow rate units") is displayed.

8 Press the **SAMPLE** key to display Ct AUTO .

9 Press the **ZERO** key to switch ON/OFF.

10 Press the **PRINT** key to store.

11 Press the **CAL** key to return to weighing display.

If set to OFF, refer to "(1) Manual Setting" to set the flow calculation time.

If set to ON, refer to "(2) Automatic Setting" to set the flow rate calculation accuracy.

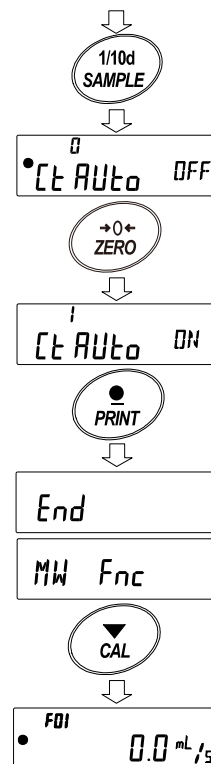

(1) Manual setting

When the manual setting is selected, the values shown in the table below can be set.

Flow rate calculation time (Ct)		
Second(s) [s]	Minute(s) [m]	Hour(s) [h]
1	1	1
2	2	/
5	5	
10	10	
20	20	
30	30	

Selecting the flow rate calculation time (Ct)

The flow rate calculation time can be changed by the following procedure.

1. When the weighing display is shown, press and hold the **MODE** key for 2 seconds to display ϵt 2 SEC.

2. Settings ranging from 1 second to 1 hour can be selected.

ZERO (+) key Changes the flow rate calculation time.

MODE (-) key Changes the flow rate calculation time.

PRINT key Stores the selected setting.
Proceeds to step 3.

CAL key Returns to weighing display or flow rate display without storing the set value.

3. When the flow rate unit is in grams (g/*) the weighing or flow rate display will appear.

When the flow rate unit is milliliters (mL/*), the density setting display will appear.

Refer to "13-2-4. Density input and settings".

Note In place of "*" (g/*, mL/*), the unit (s, m, or h) of set time is displayed.

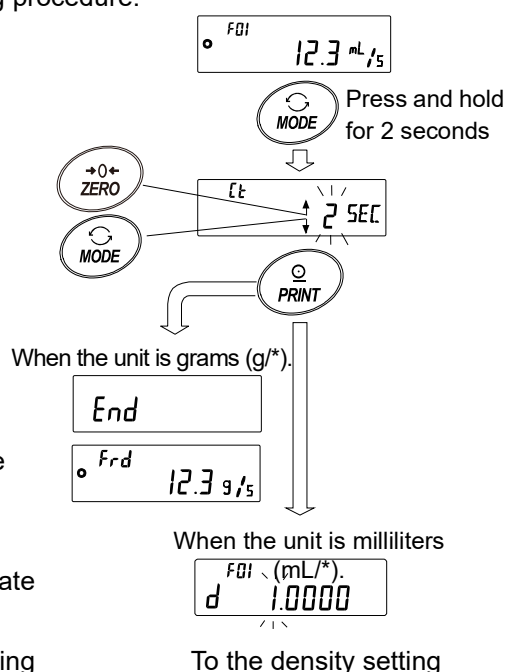

General settings

General standards of the flow rate value by model are as follows:

Model in use	Range of flow rate value (mL/m)
0.1 g model	1 to 5000
1 g model	10 to 5000

Note Depending on the type of sample to be measured, the above ranges may not apply.

The general standard settings of flow rate value and flow rate calculation time by model:
 The area marked in grey () in each table shows the standard settings of the flow rate calculation time for various flow rates (mL/m).

Note If the flow rate value does not stabilize with the following settings, set a longer flow rate calculation time.

When the 0.1 g model is used:

Flow rate (mL/m)	Priority to response ←				Ct setting			→ Priority to accuracy			
	1 second	2 seconds	5 seconds	10 seconds	20 seconds	30 seconds	1 minute	2 minutes	5 minutes	10 minutes	
1											
2											
5											
10											
20											
50											
100											
200											
500											
1000											
2000											
5000											

e.g.) To measure the flow rate of 2000 mL/m, set the flow rate calculation time to 1 second and 5 seconds.

When the 1 g model is used:

Flow rate (mL/m)	Priority to response ←				Ct setting			→ Priority to accuracy			
	1 second	2 seconds	5 seconds	10 seconds	20 seconds	30 seconds	1 minute	2 minutes	5 minutes	10 minutes	
10											
20											
50											
100											
200											
500											
1000											
2000											
5000											
10000											

e.g.) To measure the flow rate of 2000 mL/m, set the flow rate calculation time to 5 seconds and 30 seconds.

(2) Automatic setting

Flow rate measurement can be performed without having to manually select the flow rate calculation time (Ct) for the flow rate.

The flow rate calculation time will be determined between 1 second and 60 seconds according to the flow rate value being measured.

With automatic setting, after stored data is initialized the flow rate can be calculated in 1 second from the start of weighing.

Additionally, flow rate calculation accuracy can be selected from three levels: "Priority to accuracy (resolution 500)", "Standard setting (resolution 200)", and "Priority to response (resolution 50)".

Note If the flow rate value does not stabilize after 1 minute has elapsed from the start of weighing, set the accuracy setting to "Priority to accuracy (resolution 500)", or set " [t AUTO] " to " 0 " and set the flow rate calculation time manually to 2 minutes or longer.

Method of selecting flow rate calculation accuracy

The flow rate calculation accuracy can be changed by performing the following procedure.

1. When the weighing display is shown, press and hold the **MODE** key for 2 seconds to display **Fr RES**.

2. Press the **ZERO** key to change to the desired setting value.

Setting value	Description
0	Priority to accuracy (resolution 500)
1	Standard setting (resolution 200)
2	Priority to response (resolution 50)

■ Factory setting

3. Press the **PRINT** key to store the setting.

When the flow rate unit is grams (g/*), the weighing or flow rate display will appear.

When the flow rate unit is milliliters (mL/*), the density setting display will appear.

Refer to "13-2-4. Density input and settings".

Note In place of "*" (g/*, mL/*), the unit (s, m, or h) of set time is displayed.

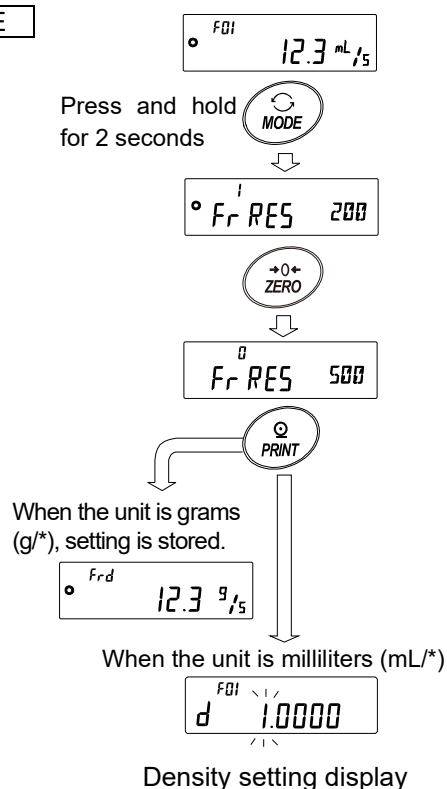

Flow Rate Display Update Timing

The display update timing is the interval at which the flow rate value displayed on the balance is updated. Output can be set at the desired timing.

(1) When the flow rate calculation time is set automatically.

The display update timing of the flow rate is 1 second or 2 seconds.

(2) When the flow rate calculation time is set manually.

The relationship between flow rate calculation time and flow rate update timing is as follows.

Flow rate calculation time (Ct)	Display update	Flow rate calculation time (Ct)	Display update	Flow rate calculation time (Ct)	Display update
1 second	1 second	30 seconds	1 second	20 minutes	10 seconds
2 seconds	1 second	1 minute	1 second	30 minutes	15 seconds
5 seconds	1 second	2 minutes	1 second	1 hour	30 seconds
10 seconds	1 second	5 minutes	3 seconds		
20 seconds	1 second	10 minutes	5 seconds		

13-2-4. Density input and settings

When the flow rate unit is set to "mL/s," "mL/m," or "mL/h" (function table Fr Unit is "3", "4", or "5"), density can be entered. Density input enables conversion of mass to volume and calculation of the flow rate value in mL.

Up to 10 densities can be stored in the density memory slots F01 to F10. Density can be set in advance for use with different measurement samples.

Density input

After setting the flow rate calculation time or flow rate calculation accuracy, it is possible to input the density.

The selected density memory slot can be changed. The initial value for each density memory slot is 1.0000 g/cm³.

- 1 When the weighing display is shown, press and hold the MODE key for 2 seconds, select the flow rate calculation time value or select the flow rate calculation accuracy, and press the PRINT key to enter.

- 2 Density setting display d 1.0000 is displayed.

- 3 The density can be changed with the following keys.
The setting range is from 0.0001 g/cm³ to 9.9999 g/cm³.

- ZERO (+) key Changes the value of the blinking digit.
- MODE (-) key Changes the value of the blinking digit.
- SAMPLE key Shifts the blinking digit.
- PRINT key Stores the set value and returns to the weighing display or flow rate display.
- CAL key Without storing the set value, returns to the weighing display or flow rate display.

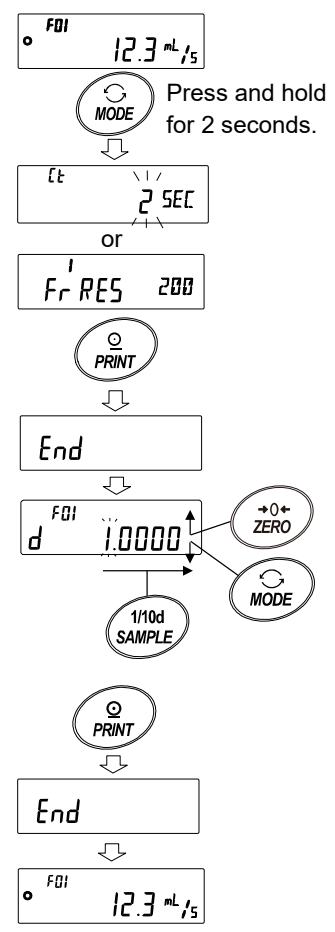

Selection of the density memory slot

Up to 10 densities can be registered when the flow rate unit is in milliliters (mL/*).

To register a new density, select unused density memory slot and then register according to the density input procedure.

- 1 When the weighing display is shown, press and hold the **PRINT** key for 2 seconds to display **d *.******.

The blinking **F**** shows the current density memory slot, and **d *.****** shows the registered density value.

- 2 The density memory slot can be changed with the following keys
The setting range is from F01 to F10.

ZERO (+) key Changes the density memory slot.

MODE (-) key Changes the density memory slot.

PRINT key Reads out the density stored in the selected density memory slot and returns to the weighing or flow rate display.

CAL key Returns to the weighing or flow rate display without reading the density stored in the selected density memory slot.

Note **F**** shows the selected density memory slot.

d *.**** shows the registered density value.

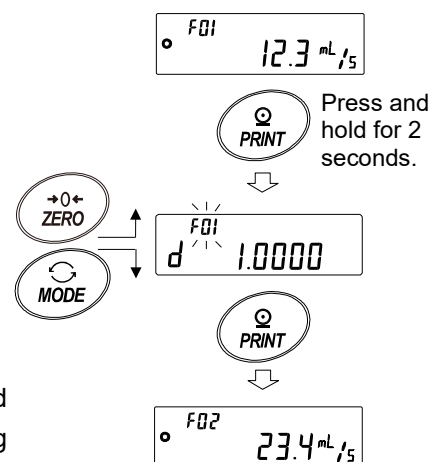

13-2-5. Switching displays

Switching between the flow rate display and weighing display

In flow rate measurement mode, **Frd** or **F**** is displayed and the unit is grams.

Pressing the **MODE** key toggles between the flow rate display and the weighing display.

By switching the display, both the weighing value and flow rate value can be checked.

Note **F**** shows the selected density memory slot.

E.g.: F01 to F10

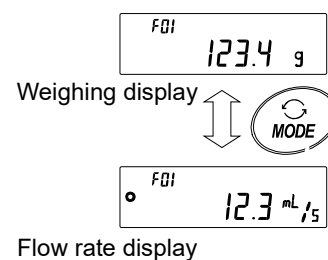

Readability digit display ON/OFF

Pressing the **SAMPLE** key toggles ON/OFF of the readability digit display.

By reducing the display one digit, the variation in flow rate values is reduced.

Note To reduce the variation in the flow rate values without turning off the digit display, change the flow rate calculation time setting.

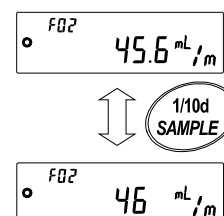

13-3. Example of use

13-3-1. Example of flow rate measurement with pump

1. Prepare the necessary equipment, such as pumps, sample fluids and containers. Confirm that the balance is in the flow rate measurement mode.

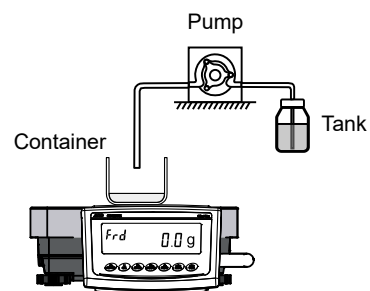

2. Press the **ZERO** key of the balance to set the weighing display to zero.

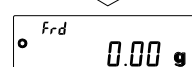

3. Turn on the pump and start measurement.

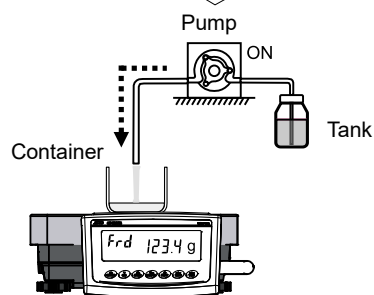

4. By switching the display using the **MODE** key, the flow rate value and the weighing value can be checked.

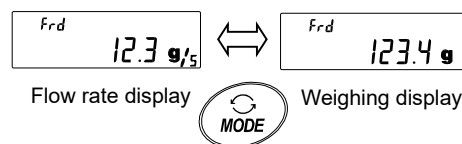

If the flow rate does not stabilize, turn off the readability digit display using the **SAMPLE** key or set a longer flow rate calculation time (Ct).

13-4. Using the comparator

When the Flow rate display (FRD) function is used with the comparator, either weighing value (in grams) or flow rate value can be chosen as a comparison target.

The setting can be changed with "Flow rate comparator [P-Frd]" of "Comparator [P Fnc]".

In the default factory settings, comparison by flow rate value is set.

If the optional GXL-04 is used, contact output of the comparison result can be performed.

For details about usage of the comparator functions, refer to "9-5. Comparator function".

13-4-1. Changing comparison target value

- 1 With the weighing display displayed, press and hold the **SAMPLE** key for 2 seconds to display **bASFnC**.
- 2 Press the **SAMPLE** key several times to display **[P Fnc]**.
- 3 Press the **PRINT** key to display **[P⁰ OFF]**.
- 4 Press the **SAMPLE** key several times to display **[P-Frd]**.
- 5 Press the **ZERO** key to switch **Frd** (comparison by flow rate value) to **WT** (comparison by weighing value).
- 6 Press the **PRINT** key to store.
(To cancel, press the **CAL** key.)
- 7 To return to the weighing display, press the **CAL** key.

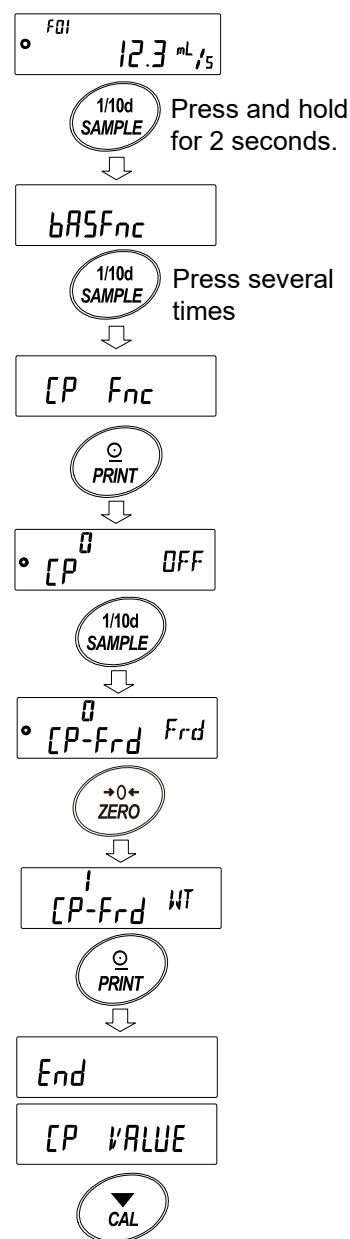

13-4-2. Example of using the comparator

Filling 100 g with the contact output of the GXL-04 and the pump.
 (When the weighing value reaches 100 g, HI contact output from the balance stops the pump.)

Note Confirm that the pump is equipped with a contact input.

Note Refer to the instruction manual of the pump for details on cable wiring for the GXL-04 and the pump.
 (Wire HI output of GXL-04 with the stop line of the pump.)

Set " [P] " to " 2 " in the function table " [P Fnc] ".

1. When the weighing display is shown, press and hold the SAMPLE key for 2 seconds to display bRSFnc.
2. Press the SAMPLE key several times to display [P Fnc].
3. Press the PRINT key to display [P⁰ OFF].
4. Press the ZERO key several times to display [P² ALL].
5. Press the PRINT key to store.
6. [P VALUE] (comparator threshold) is displayed.
 Press the PRINT key.

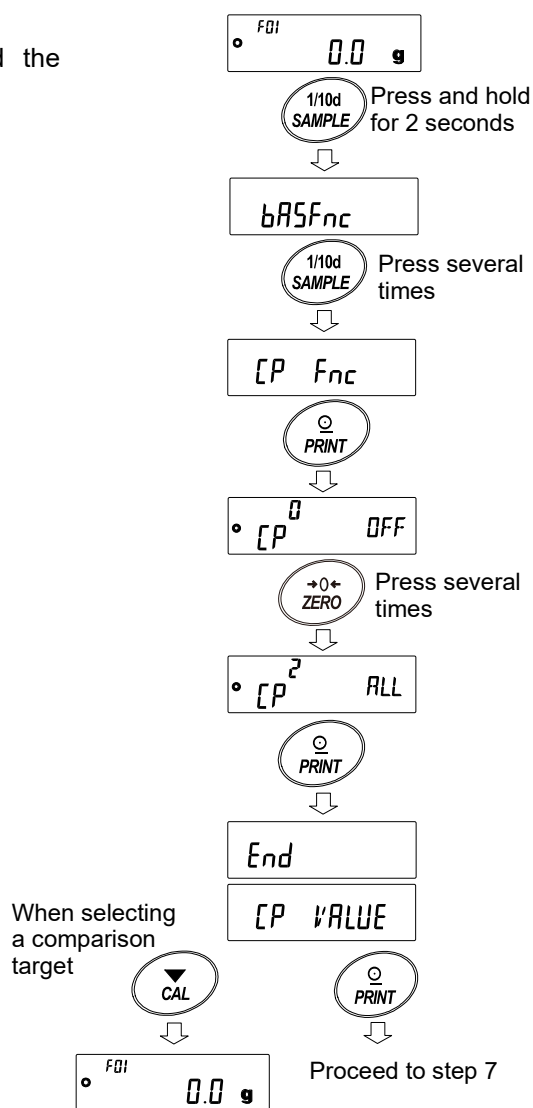

To select a new comparison target (weighing value/flow rate value), press the CAL key to return to the weighing display and follow the procedure in "13-4-1. Changing comparison target value".

Entering a HI value

7. When [CP Hi] is displayed, press the [PRINT] key.

8. The current value is displayed. (All lights on)

9. If the setting does not need to be changed, press the [PRINT] key or [CAL] key to proceed to step 11.

10. To change the setting value, press the [ZERO] key and perform registration with the following keys.

- [SAMPLE] key ... Shifts the blinking digit.
- [ZERO] key Changes the value of the blinking digit.
- [MODE] key Reverses the polarity.
- [PRINT] key Registers and proceeds to step 11.
- [CAL] key Cancels and proceeds to step 11.

e.g.: Set [CP Hi] to 100 g and press the [PRINT] key.

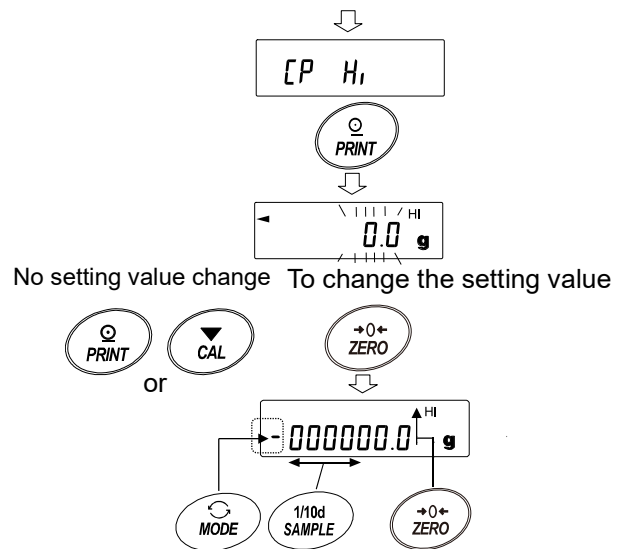

11. Press the [CAL] key twice to return to the weighing display.

12. Press the [ZERO] key on the balance to return the weighing value to zero. Turn on the pump and start measurement.

13. When 100 g is reached, the balance generates a contact output to stop the pump.

Note In this state, if entering the internal setting or turning off the display, the contact output will be off and the pump may start again. Please turn off the pump before performing the next procedure.

14. Depending on the settings of the balance and pump, the target value may be exceeded. In that case, it can be adjusted by setting a smaller value.

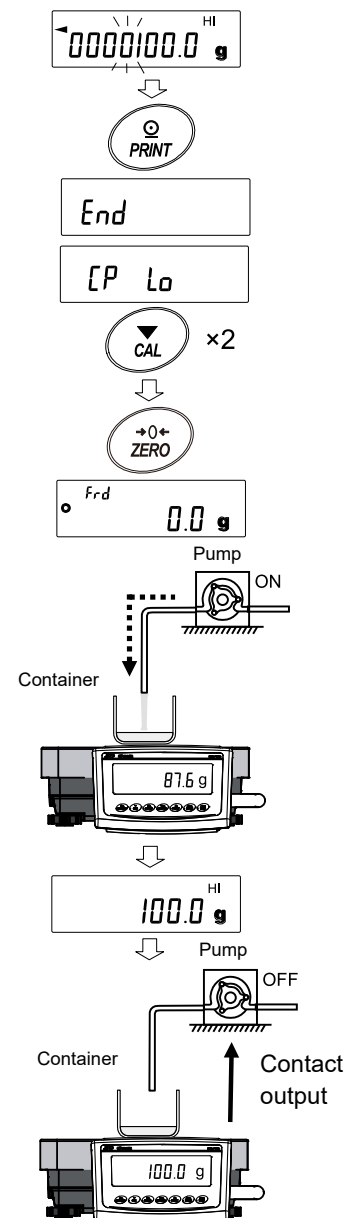

13-5. Using analog voltage output

Using the optional GXL-06 analog voltage output allows the flow rate value to be output as analog voltage.

With this option, FRD mode operates differently than the normal weighing mode.

- Only flow rate value can be output as analog voltage.
- "Analog output method (FR)" only supports two-digit output " 0 " or three-digit output " | ".
When net full scale output " 2 " or gross full scale " 3 " is selected, the output of analog voltage is always 0 V.

For details about the analog voltage output settings, refer to the instruction manual of the optional GXL-06 analog voltage output.

13-5-1. Example of using analog voltage output

Note

- ❑ Install the GXL-06 on the balance.
- ❑ Switch the slide switch on the option panel to select the voltage output range. (0 - 1 V or 0.2 - 1 V)
- ❑ Perform fine adjustment of the voltage output if necessary.

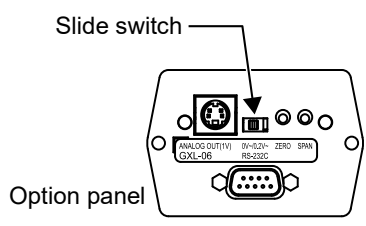

Changing the function table

In three-digit output mode, when the readability is set to display the second digit:

1. When the weighing display is shown, press and hold the **SAMPLE** key for 2 seconds to display the function table mode **bR5Fnc**.
2. Press the **SAMPLE** key several times to display **Rout**.
3. Press the **PRINT** key to display **Rn⁰ 2d**.
4. Press the **ZERO** key several times to change to three-digit mode **Rn¹ 3d**.
5. Press the **SAMPLE** key to display **SEL⁰ 1d**.
6. Press the **ZERO** key to change the readability setting to display the second digit **SEL¹ 2d**.
7. Press the **PRINT** key to store.
(To cancel, press the **CAL** key.)
8. Press the **CAL** key to return to weighing display.
9. When the flow rate value is 12.3 g/m, the voltage output is 0.123 V (0.2 - 1 V), 0.298 V (0.2 - 1 V).

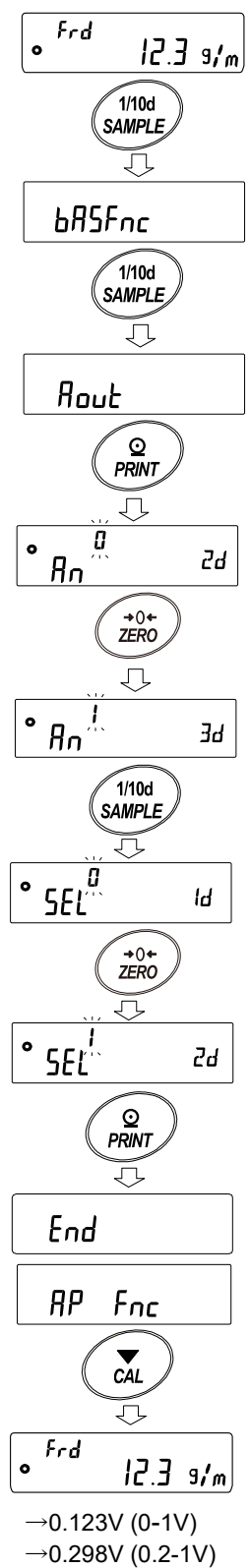

13-6. Commands

The specified commands sent from a PC to the balance can be used to request weighing data, operate the keys, change the settings values and so on. To send a command to the balance, add a terminator (<CR> <LF> or <CR> in the function table “ [rLF ”) to the command character string.

Commands to request weighing data and flow rate data

Command characters	Description/Example of response
Q	Immediately requests the weighing data displayed on the balance. Response example: <code>S T , + 0 0 0 0 0 0 0 . 9 _ _ g</code> or <code>F L , + 0 0 0 0 1 0 0 . 0 g / s</code>
QW	Immediately requests the weighing data. Response example: <code>S T , + 0 0 0 0 1 0 0 . 0 _ _ g</code>
QF	Immediately requests the flow rate data. Response example: <code>F L , + 0 0 0 0 1 0 0 . 0 g / s</code>
QWF	Requests the weighing data and flow rate data after stabilization. Response example: <code>U S , + 0 0 0 0 0 0 0 . 2 _ _ g , F L , + 0 0 0 0 0 0 0 . 1 g / s</code>

Note When the flow rate is excessive, the output may not be made correctly. In this case, please change the flow rate unit and reduce the number of digits.

└ Space,ASCII20h.

Commands to set the parameters (Enter the number to be set in place of *)

Command characters	Description/Example of command
CT:**s Note 1)	Changes the flow rate calculation time (Ct). E.g. 5 seconds ... <code>C T : 0 5 s</code> 30 minutes ... <code>C T : 3 0 m</code> 1 hour ... <code>C T : 0 1 h</code>
FN: **	Changes the density memory slot. Enter a number from 01 to 10 in place of **. E.g. Change the density memory slot to 05 <code>F N : 0 5</code>
FD: *.****	Sets the density value of the currently selected density memory slot. E.g. Set the density to 0.9969 g/cm ³ <code>F D : 0 . 9 9 6 9</code>
FD:○○;*.****	Sets the density value of a specified density memory slot. E.g. Set the density value of density memory slot 03 to 0.9971 g/cm ³ <code>F D : 0 3 ; 0 . 9 9 7 1</code>
FA: **	Sets the flow rate calculation accuracy for the automatic setting of the flow rate calculation time (Ct). E.g. Set the flow rate calculation accuracy to “Priority to response” <code>F A : 0 2</code>

Note 1) The numeric values that can be set with “**” of the “CT:**s” command are as follows:

01, 02, 05, 10, 20, 30

Commands to check the parameters

Command characters	Description/Example of response
?CT	Requests the flow rate calculation time (Ct). E.g.) <code>CT,10min</code> ... Flow rate calculation time (Ct) is 10 minutes.
?FN	Requests the currently selected density memory slot. E.g.) <code>FD,05</code> The density memory slot is 05.
?FD	Requests the density value stored in the currently selected density memory slot. E.g.) <code>FD,1.0000</code> The density is 1.0000 g/cm ³ .
?FD**	Requests the density value stored in density memory slot **. Enter the number from 01 to 10 in place of **. E.g.) <code>FD,05;1.0000</code> The density stored in density memory slot 05 is 1.0000 g/cm ³ .
?FA	Requests the flow rate calculation accuracy for the automatic setting of the flow rate calculation time (Ct). E.g.) <code>FA,01</code> The flow rate calculation accuracy is the standard setting.

The commands for the Flow Rate Display (FRD) function are described here.

For other commands with key operations, refer to [“21-7. Commands”](#).

14. Minimum Weight Alert Function

Minimum weight is the minimum sample weight required to perform correct quantitative analysis taking the measurement error of the balance used into account. If the sample amount is too small, the proportion of measurement error in the measured value increases, and the reliability of the analysis result thus may drop.

The minimum weight alert function makes it possible to judge immediately whether the sample amount meets the set minimum weight. This function can be used only with "g" mode. With this function, "MIN" displays at the top of the unit.

"MIN" displays blinking when the sample amount is less than the set minimum weight. When the sample amount exceeds the set minimum weight, "MIN" is hidden.

The minimum weight can be changed in the function table.

Note that when the set value is 0 g, the alert is not displayed even if the minimum weight alert function is enabled (MW-[P 1 or 2]). Also, the minimum weight cannot be set above the weighing capacity.

There are two types of alert displays:

"Excluding near zero"

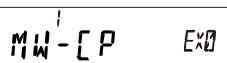

"Including near zero"

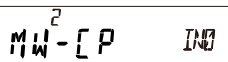

Near zero is within 0 g ±10 d.

Caution

- This function cannot be used together with the statistical calculation function and data memory function.

14-1. Minimum weight comparison

Setting procedure

1. Press and hold the **SAMPLE** key for 2 seconds to display **bRSFnC**.
2. Press the **SAMPLE** key several times to display **MWFnC**.
3. Press the **PRINT** key.
4. **MWFnC** appears. Press the **ZERO** key to switch the display form **MW⁰-[P OFF]** to **MW¹-[P EX0]** (excluding near zero) or **MW²-[P IN0]** (including near zero).
5. To change the minimum weight setting, proceed to step 6. To return to weighing mode without changing the minimum weight, press the **CAL** key.
6. Press the **SAMPLE** key to display **MW**.

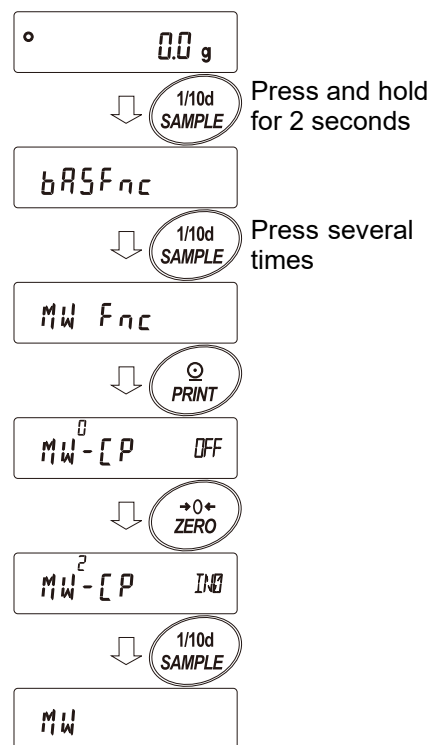

14-2. Input and output of minimum weight

14-2-1. Setting procedure using the function table

[Direct input of setting value]

Continue from step 6 of “14-1. Minimum weight comparison”.

7. With **MW** displayed, press the **PRINT** key.
8. With **KEY in** displayed, select either operation:
 - To set the minimum weight, press the **PRINT** key again to proceed to step 9.
 - To return to weighing mode without setting the minimum weight, press the **CAL** key twice.
9. Set the minimum weight using the following keys.
 - ZERO** (+) key..... Changes the value of the blinking digit.
 - MODE** (-) key..... Changes the value of the blinking digit.
 - SAMPLE** key..... Selects the digit to blink.
 - PRINT** key..... Stores the value and proceeds to the next item.

Note If “MW-[P]” is set to “0”, it will be automatically changed to 1 (excluding near zero) and the minimum weight comparison function will be enabled.

 - CAL** key Cancels the setting and proceeds to the next item.
10. Press the **CAL** key to return to weighing mode.

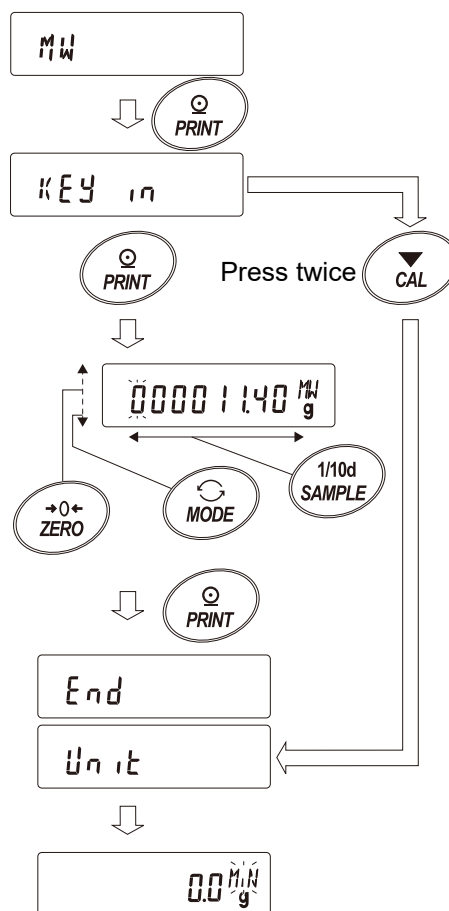

[Input using repeatability with an external weight]

Continue from step 6 of “14-1. Minimum weight comparison”.

7. With **MW** displayed, press the **PRINT** key to display **KEY in**.

8. Press the **SAMPLE** key to display **Ext MASS**.

9. Press the **PRINT** key. **StArT**, **READY**, and weighing display appear, and then **LoAD** is displayed requesting the first load for repeatability measurement.

10. Place an external weight on the weighing pan. The processing indicator (◀) lights up.

11. The processing indicator (◀) starts blinking when processing is stabilized. When it remains stable for 2 seconds, the span is displayed.

12. **REMoVE** displays blinking.

13. Remove the external weight. The processing indicator (◀) lights up.

14. The processing indicator (◀) starts blinking when processing is stabilized. When it remains stable for 2 seconds, zero is displayed.

15. **LoAD** is displayed requesting the second load for repeatability. After that, perform repeatability measurement up to the 10th time.

16. After the 10th span is displayed, **REMoVE** and **End** appear, and then **MW** ^{0.1%} **2320 g** is displayed showing the minimum weight display.

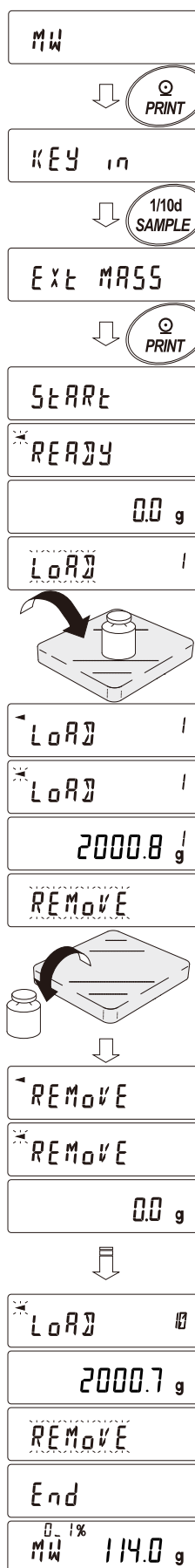

The processing indicator lights up when an external weight is placed.

The processing indicator starts blinking when processing is stabilized. When it remains stable for 2 seconds, the span is displayed.

The processing indicator lights up when the external weight is removed.

The processing indicator starts blinking when stabilized. If it remains stable for 2 seconds, zero is displayed.

Span for the 10th time is displayed.

Error messages

ξ g Load exceeding the capacity is applied.

$-\xi$ g Not enough load is applied.

Note The balance returns to repeatability measurement when the error is cleared.

$Error \ 1$ Weighing value unstable (for approx. 20 seconds) during repeatability measurement
Timeout. (After approx. 2 minutes of inactivity)

Note After $Error$ is displayed the balance will force end repeatability measurement and return to the function table.

17. The repeatability ($5\overline{7}$) and minimum weight (MW) can be selected and output.

When $MW \ 114.0 \ g$ is displayed, pressing the $SAMPLE$ key switches between the minimum weight (MW) and repeatability ($5\overline{7}$), and pressing the $MODE$ key switches the measurement tolerance.

[Example of minimum weight batch output]

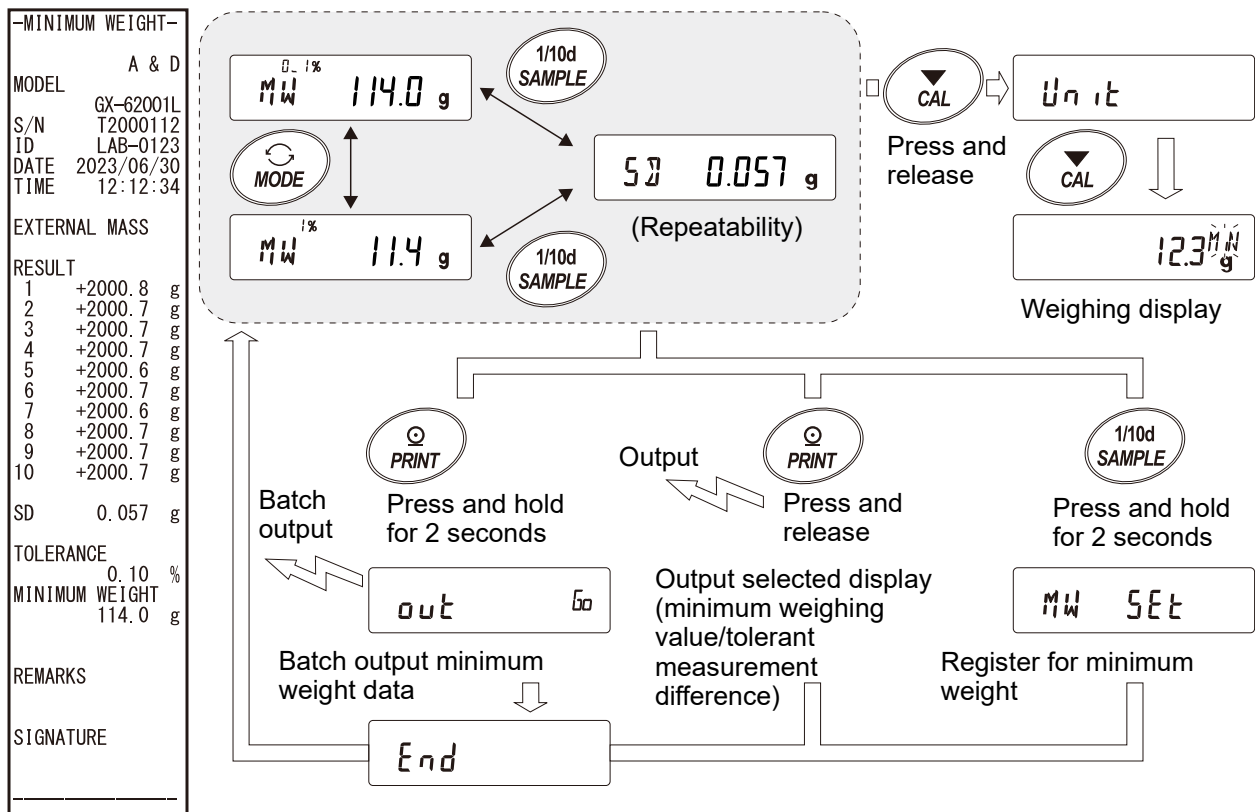

18. Press the $PRINT$ key to output the display selected in step 17 (repeatability " $5\overline{7}$ " / minimum weight " MW "). Press and hold the $PRINT$ key for 2 seconds to output data in batch.

19. When the output is completed, $MW \ 114.0 \ g$ appears.

20. Press and hold the $SAMPLE$ key for 2 seconds to store the minimum weight and return to $MW \ 114.0 \ g$.

Note The parameter is automatically set to " 1 " (excluding near zero) when " $MW-CP$ " is set to " 0 ", and the minimum weight comparison function is enabled.

21. Press the CAL key twice to start the minimum weight alert function in weighing mode.

14-2-2. Procedure to set in weighing mode

1. Press the **MODE** key in weighing mode.

When **MW 114.0^{KEY}g** is displayed, press the **PRINT** key.

2. **KEY in** appears.

After this, perform the minimum weight setting from step 8 of "[Direct input of setting value]" or step 8 of "[Input using repeatability with an external weight]" in "14-2-1. Setting procedure using the function table".

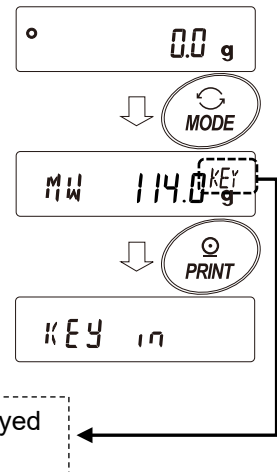

- KEY** Set value input
- Ext** Input using repeatability with an external weight
- ECL** Input with ECL (press and hold the **MODE** key).
Refer to "6-2. Self check function / automatic setting of minimum weight with ECL".

14-2-3. Procedure to output the settings in batch

The set minimum weight and repeatability result can be output in batch.

1. With **KEY in** or **Ext MASS** displayed, press and hold the **PRINT** key for 2 seconds.

2. Pressing the **ZERO** key toggles between "No" and "Go" of the **out** display. Select "Go" and press the **PRINT** key to output the settings in batch.

When the batch output is completed, **End** appears and then the display returns to **KEY in** or **Ext MASS**.

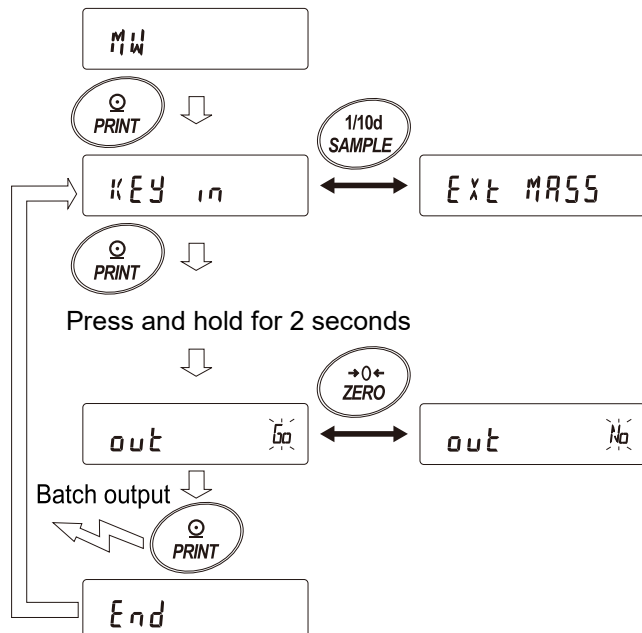

[The set minimum weight]

The output content depends on the minimum weight setting method.

Set with **KEY IN**

-MINIMUM WEIGHT-	
A & D	
MODEL	GX-62001L
S/N	T2000112
ID	LAB-0123
DATE	2023/06/30
TIME	12:12:34
KEY INPUT	
MINIMUM WEIGHT	114.0 g
REMARKS	
SIGNATURE	

Set with **Ext MASS**

-MINIMUM WEIGHT-	
A & D	
MODEL	GX-62001L
S/N	T2000112
ID	LAB-0123
DATE	2023/06/30
TIME	12:12:34
EXTERNAL MASS	
RESULT	
1	+2000.8 g
2	+2000.7 g
3	+2000.7 g
4	+2000.7 g
5	+2000.6 g
6	+2000.7 g
7	+2000.6 g
8	+2000.7 g
9	+2000.7 g
10	+2000.7 g
SD	0.057 g
TOLERANCE	
	0.10 %
MINIMUM WEIGHT	114.0 g
REMARKS	
SIGNATURE	

Set with ECL

-MINIMUM WEIGHT-	
A & D	
MODEL	GX-62001L
S/N	T2000112
ID	LAB-0123
DATE	2023/06/30
TIME	12:12:34
ECL	
RESULT	
1	+200.7 g
2	+200.6 g
3	+200.6 g
4	+200.6 g
5	+200.5 g
6	+200.6 g
7	+200.5 g
8	+200.6 g
9	+200.6 g
10	+200.6 g
SD	0.057 g
TOLERANCE	
	0.10 %
MINIMUM WEIGHT	114.0 g
REMARKS	
SIGNATURE	

14-3. Outputting data less than the minimum weight

Output of the data less than the minimum weight can be switched ON/OFF with the **Min out** setting of the function table.

Setting procedure

1. In weighing mode, press and hold the **SAMPLE** key for 2 seconds to display **bASFnC**.
2. Press the **SAMPLE** key several times to display **MW FnC** key, and then press the **PRINT** key.
3. Press the **SAMPLE** key several times until **Min out** is displayed.
4. Press the **ZERO** key to select either **Min out ON** (data output ON) or **Min out OFF** (data output OFF).
5. To proceed to the next item, press the **PRINT** key.
6. To return to weighing mode, press the **CAL** key.

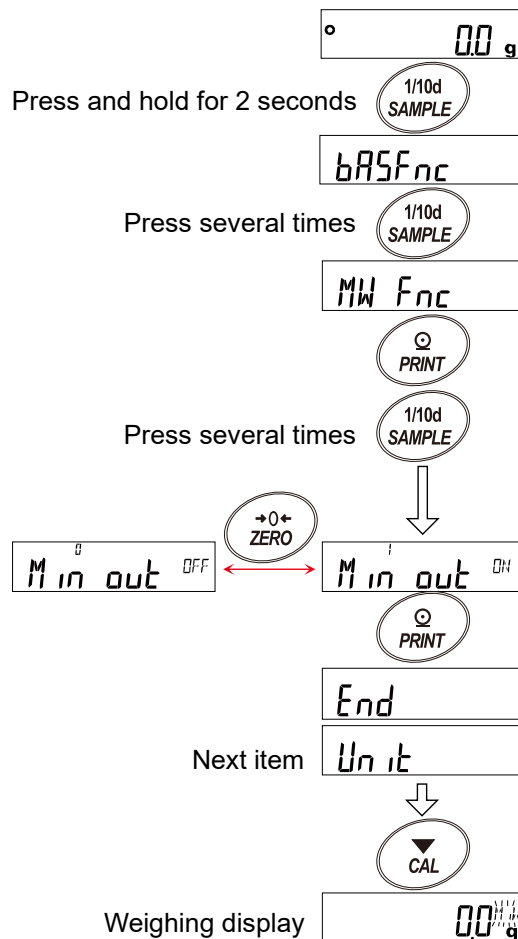

15. Density (Specific Gravity) Measurement

The balance has a density mode that calculates the density of a solid or liquid from the weight in air and the weight in liquid.

Caution

- The density mode is disabled by default. To use the density mode, the function table needs to be changed in order to enable the density mode " $d5$ ". Please refer to "9-9. Storing units".
- Readability of weighing value is fixed in density mode.

Density formula

1. Density of a solid:

The density can be obtained from the weight of the sample in air, the weight in liquid, and the density of the liquid.

$$\rho = \frac{A}{A-B} \times \rho_0$$

ρ : Density of sample A : Weight of sample in air
 ρ_0 : Density of liquid B : Weight of sample in liquid

2. Density of a liquid:

The density of a liquid can be obtained from the weight of the float in air, the weight of the float in a liquid, and the known volume of the float.

$$\rho = \frac{A-B}{V}$$

ρ : Density of sample A : Weight of float in air
 V : Density of float B : Weight of float in liquid

15-1. Preparing for measurement (Changing the function table)

Prior to measurement, change the function table as follows:

- Enabling the density mode:
The density mode is not enabled at the factory settings. Refer to "9-9. Storing units" to register the density mode ($d5$). The density mode can be selected as a unit using the **MODE** key.
- Selecting the sample:
Select either solid or liquid for the sample to be measured. (Function table $d5 Fnc, d5$)
- For solid density measurement, select a liquid density input method. (Function table $d5 Fnc, Ldin$)
There are two ways to set the density of the liquid: by entering the water temperature, and by directly entering the density. Select the input method using the following function table.
- To start measurement, switch the balance to weighing mode. Press the **MODE** key to switch to density mode display. For the measurement procedure, refer to "15-2. Measuring the density (specific gravity) of a solid (Function table $d5 \square$)" and "15-4. Measuring the density (specific gravity) of a liquid (Function table $d5 |$)".

Caution

- The following density function table ($d5 Fnc$) cannot be displayed unless the density mode is enabled. Make sure to perform registration of the density mode in the unit setting ($Unit$) of the function table first. When the density mode is enabled, " $d5 Fnc$ " is displayed after " $Unit$ ".

To change the function table, refer to "9. Function Table".

Class	Item	Parameter	Description
$d5 Fnc$ Density measurement function	$Ldin$ Liquid density input	■ \square	Water temperature ■ Factory setting
			Liquid density
	$d5$ Sample selection	■ \square	Solid density measurement ■ Factory setting
			Liquid density measurement

15-2. Measuring the density (specific gravity) of a solid (Function table $d5$ ρ)

Caution: If temperature of the liquid changes during measurement or when type of liquid is changed, reset the density of a liquid by "15-3. Inputting the density of a liquid" as necessary. In density display, the 3 digits after the decimal point are fixed. The readability cannot be changed with the **[SAMPLE]** key.

In density measurement, the density is fixed and displayed according to weight in air measurement and weight in liquid measurement. The relationship between each state and display is as follows.

Measurement procedure

- In weight in air measurement mode (g lights, $\rightarrow\leftarrow$ blinks), press the **[ZERO]** key to display zero with nothing on the weighing pan.
Place a sample on the weighing pan in air and wait for the display to stabilize. To output the sample weight, press the **[PRINT]** key. Next, press the **[SAMPLE]** key to confirm the weight in air and enter the weight in liquid measurement mode (g lights, \leftarrow lights).
- Transfer the sample from the weighing pan in air to the weighing pan in liquid and wait for the display to stabilize.
To output the sample weight, press the **[PRINT]** key. Next, press the **[SAMPLE]** key to confirm the weight in liquid and enter the density input mode (g turns off, \leftarrow lights).
- Input the density of the liquid.
Set the density by referring to "15-3. Inputting the density of a liquid". Next, press the **[PRINT]** key to enter the density mode. (g turns off, \leftarrow lights).
- To output the density, press the **[PRINT]** key.
To measure another sample, press the **[SAMPLE]** key and start with weight in air measurement mode. The density unit is " ρ ".
- If temperature of the liquid changes during measurement or when type of liquid is changed, reset the density of the liquid with "15-3. Inputting the density of a liquid" as necessary.
- Press the **[MODE]** key to enter other weighing mode.

15-1. Preparing for measurement (Changing the function table)

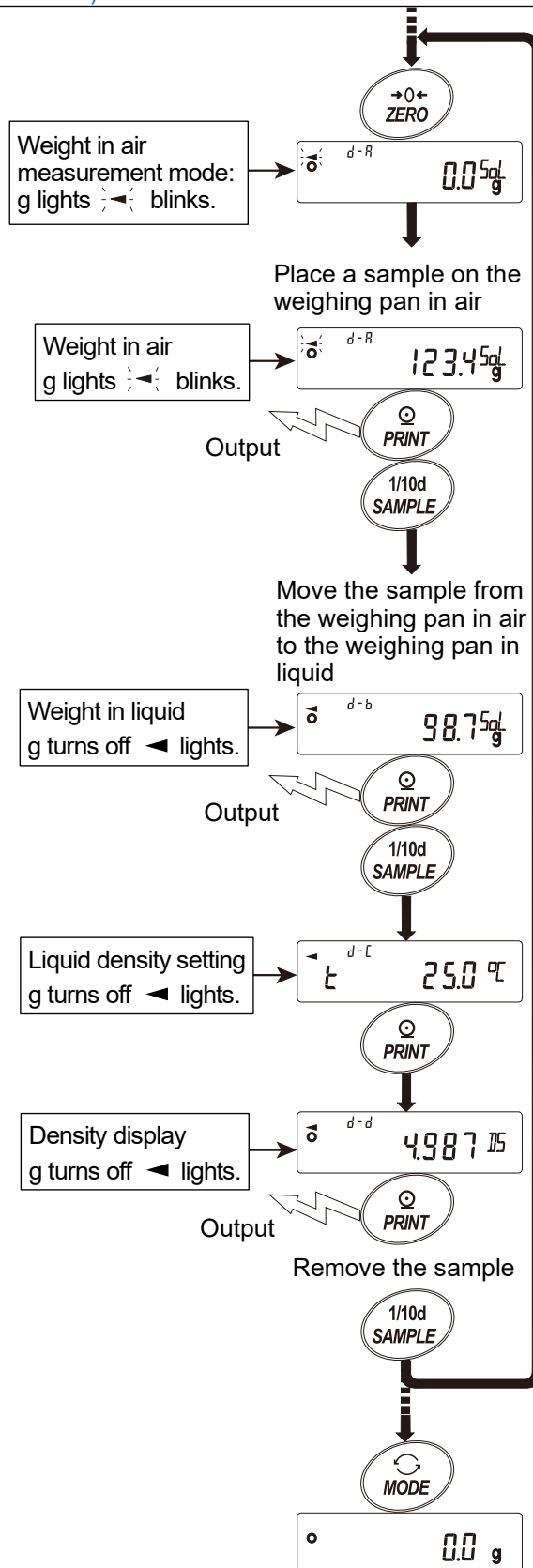

15-3. Inputting the density of a liquid

With the setting of "Liquid density input (Ld_{in})" in the function table, water temperature input mode or density input mode is selected as described below.

Water temperature input mode (Ld_{in} 0)

The currently set water temperature (unit: °C, factory setting: 25.0°C) is displayed.

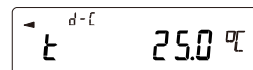

The set water temperature can be changed with the following keys. Set a value between 0.0°C to 99.9°C, with 0.1°C increments. Refer to the correspondence table of water temperature and density below.

ZERO (+) key..... Changes the value of the selected (blinking) digit. (0 appears next to 9.)

MODE (-) key..... Changes the value of the selected (blinking) digit. (9 appears next to 0.)

SAMPLE key..... Selects the digit to blink.

PRINT key..... Stores the set value and enters the density mode. (To step 5 on the previous page.)

CAL key..... Enters the density mode without storing the set value. (To step 5 on the previous page.)

Correspondence table of water temperature and density

°C	+0	+1	+2	+3	+4	+5	+6	+7	+8	+9
0	0.99984	0.99990	0.99994	0.99996	0.99997	0.99996	0.99994	0.99990	0.99985	0.99978
10	0.99970	0.99961	0.99949	0.99938	0.99924	0.99910	0.99894	0.99877	0.99860	0.99841
20	0.99820	0.99799	0.99777	0.99754	0.99730	0.99704	0.99678	0.99651	0.99623	0.99594
30	0.99565	0.99534	0.99503	0.99470	0.99437	0.99403	0.99368	0.99333	0.99297	0.99259
40	0.99222	0.99183	0.99144	0.99104	0.99063	0.99021	0.98979	0.98936	0.98893	0.98849

g/cm³

For "Density input mode" (Ld_{in} 1)

The currently set density (factory setting: 1.0000g/cm³) is displayed.

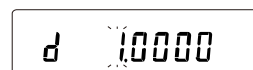

The set density can be changed with the following keys.

Set a value between 0.0000 and 1.9999 g/cm³.

If a value outside this range is input, **Error 2** is displayed and the display returns to the input display.

ZERO (+) key..... Sets the value of the selected (blinking) digit. (0 appears next to 9)

MODE (-) key..... Sets the value of the selected (blinking) digit. (9 appears next to 0)

SAMPLE key..... Selects the digit to blink.

PRINT key..... Stores the set value and enters the density mode. (To step 5 on the previous page)

CAL key..... Enters the density mode without storing the set value. (To step 5 on the previous page.)

15-4. Measuring the density (specific gravity) of a liquid (Function table $d5$)

In density display, the 3 digits after the decimal point are fixed. The readability cannot be changed with the **SAMPLE** key.

In density measurement, the density is fixed and displayed according to float weight in air measurement and float weight in liquid measurement.

The relationship between each state and display is as follows.

Measurement procedure

- In weight in air measurement mode (g lights, \leftarrow blinks), place nothing on the pan and press the **ZERO** key to display zero.
- Place the float and wait for the display to stabilize.
To output the float mass value, press the **PRINT** key.
Next, press the **SAMPLE** key to confirm the weight in air and enter weight in liquid measurement mode. (g lights, \leftarrow blinks)
- Put the liquid in the beaker and sink the float in order to measure the density.
At this time, adjust so that the float is about 10 mm below the liquid level.
- Wait for the display to stabilize. To output the sample mass value, press the **PRINT** key.
Next, press the **SAMPLE** key to confirm the weight in liquid and enter volume input mode. (g turns off, cm^3 lights, \leftarrow lights)
- Input the volume of the float.
Input the volume by referring to "15-5. Inputting the volume of the float".
Next, press the **PRINT** key to enter density display mode..
- To output the density, press the **PRINT** key.
To measure another sample, press the **SAMPLE** key and start from weight in air measurement mode. The density unit is " g/cm^3 ".
- Press the **MODE** key to enter weighing mode.

15-1. Preparing for measurement (Changing the function table)

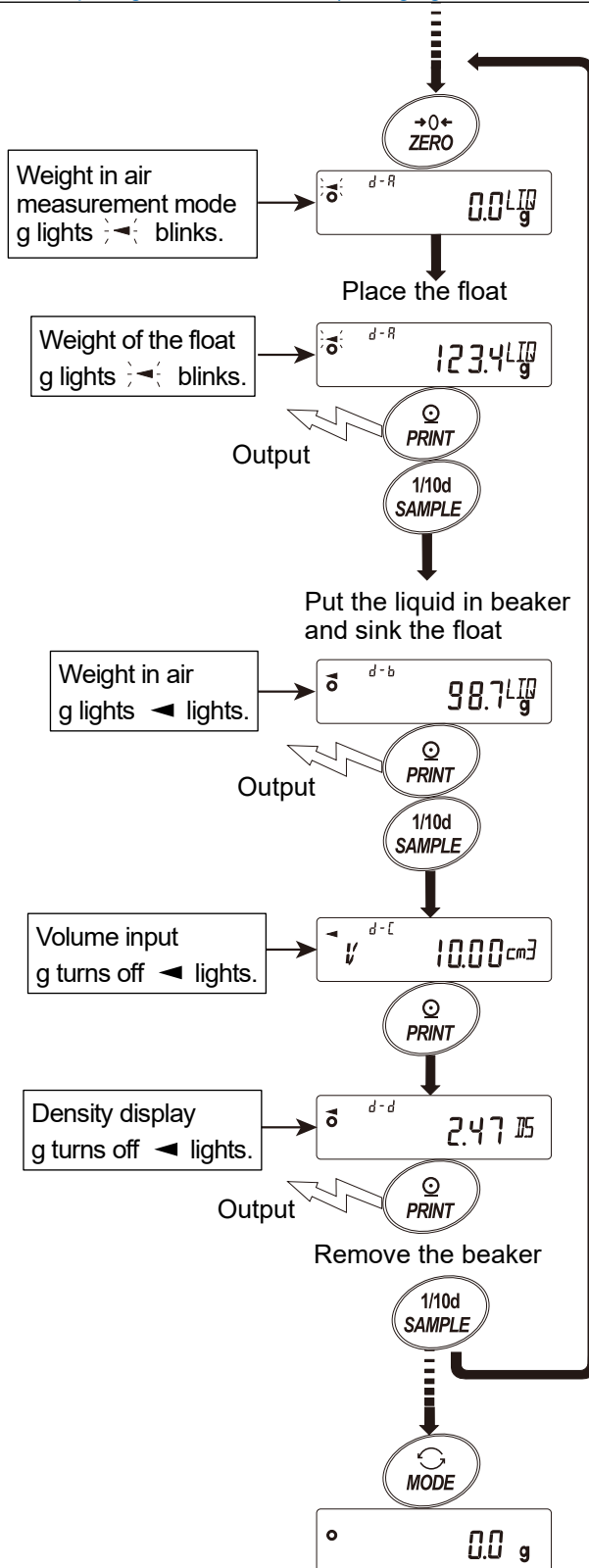

15-5. Inputting the volume of the float

The currently set volume of the float is displayed. (Factory setting is 10.00 cm³)

The set value can be changed with the following keys.

Set a value between 0.01 cm³ and 99.99 cm³ with 0.01 cm³ increments.

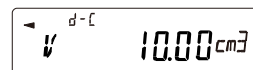

ZERO (+) key Changes the value of the selected (blinking) digit. (0 appears next to 9.)

MODE (-) key Changes the value of the selected (blinking) digit. (9 appears next to 0.)

SAMPLE key Selects the digit to blink.

PRINT key Stores the set value and enters the density display mode. (To step 5 on the previous page.)

CAL key Enters density display mode without storing the set value. (To step 5 on the previous page.)

16. Password Lock Function

The password lock function can restrict the use and functions of the balance. It is effective in preventing falsification of date and time settings or preventing changes in the function table by the user. The password is set with four digits/keys (**MODE**, **SAMPLE**, **PRINT**, **ZERO**) and four options ($4 \times 4 \times 4 \times 4 = 256$ combinations).

The password lock function is disabled by default. To enable/disable the password lock function and register a new password, change the settings in the function table.

The function can be set in three ways with the " *Lock* " setting of "Password lock function (*PASSwd*)" in the function table.

<i>Lock</i> 0	No password required
<i>Lock</i> 1	Password entry required at the start of weighing
<i>Lock</i> 2	Login with the Administrator's password required when changing settings

Lock 0 (No password required)

All functions of the balance can be used by anyone in weighing operation and settings can be changed. The password lock function is not used.

Lock 1 (Password entry required at the start of weighing)

Administrator (*ADMIN*) can limit users of the balance by setting individual passwords. (The password will be required to start weighing with the **ON:OFF** key.)

Unless the correct password is entered, the balance cannot enter weighing mode.

There are two login levels: Administrator (*ADMIN*) and User (*USER 01* to *10*).

Administrator (<i>ADMIN</i>)	All functions and settings are available.
	Passwords for 10 users can be set individually.
User (<i>USER 01</i> to <i>10</i>)	Initialization and setting changes are restricted (including clock).

Lock 2 (Login with the Administrator's password required when changing settings)

Anyone can perform weighing operations, but restrictions can be placed on initialization and setting changes (including the clock).

(Password entry using the **ON:OFF** key will not be required at the start of weighing.)

There are two login levels: Administrator (*ADMIN*) and Guest (*GUEST*).

Administrator (<i>ADMIN</i>)	All functions and settings are available.
Guest (<i>GUEST</i>)	Initialization and setting changes are restricted (including clock).

If you press and hold the **CAL** key and press the **ON:OFF** key to start weighing with the **ON:OFF** key when the display is off, password entry by the Administrator (*ADMIN*) will be required.

Restricted items according to login level

Login level	Weighing		
	Password input at the start of weighing	Sensitivity adjustment	Function setting *1
Administrator (<i>ADMIN</i>)	Required	Available	Available
User (<i>USER 01 ~ 10</i>)		Available *2	Not available
Guest (<i>GUEST</i>)	Not required		

*1 Response adjustment change, minimum weight setting, repeatability check using the internal weight, function selection and initialization, and function table (clock & calendar setting)

*2 The Administrator (*ADMIN*) can disable it by setting "Prohibit" in "8-1. [Function selection switch](#)".

16-1. Enabling password lock function

With "Password function (*PASSwd*)" set in the function table, the password function can be switched between "Disabled (*OFF*)", "Enabled (*ALL*)", and "Enabled (*Fnc*)".

1. In weighing mode, press and hold the **[SAMPLE]** key for 2 seconds to display **[bASFnC]**.
2. Press the **[SAMPLE]** key several times until **[PASSwd]** is displayed.
3. Press the **[PRINT]** key to display **LOCK OFF**.
(To cancel, press the **[CAL]** key.)
4. Press the **[ZERO]** key to display **LOCK ALL**.
(Press the **[ZERO]** key again to display **LOCK Fnc**.)
5. Press the **[PRINT]** key to display **SURE :YESNO**.
("No" is blinking while it is selected.)
6. Press the **[ZERO]** key to switch *YES / No*.
7. Display **SURE :YESNO**.
(*YES* is blinking while it is selected.)

When *YES* is selected, press the **[PRINT]** key to enable the password lock function.

(With "Lock 1" setting, you will be prompted to enter the password when the display turns on.)

8. **[PASS No]** is displayed. To register (change) a password, proceed to step 4 of "16-4. Registering (changing) password". To return to weighing mode without registering (changing) a password, press the **[CAL]** key twice.

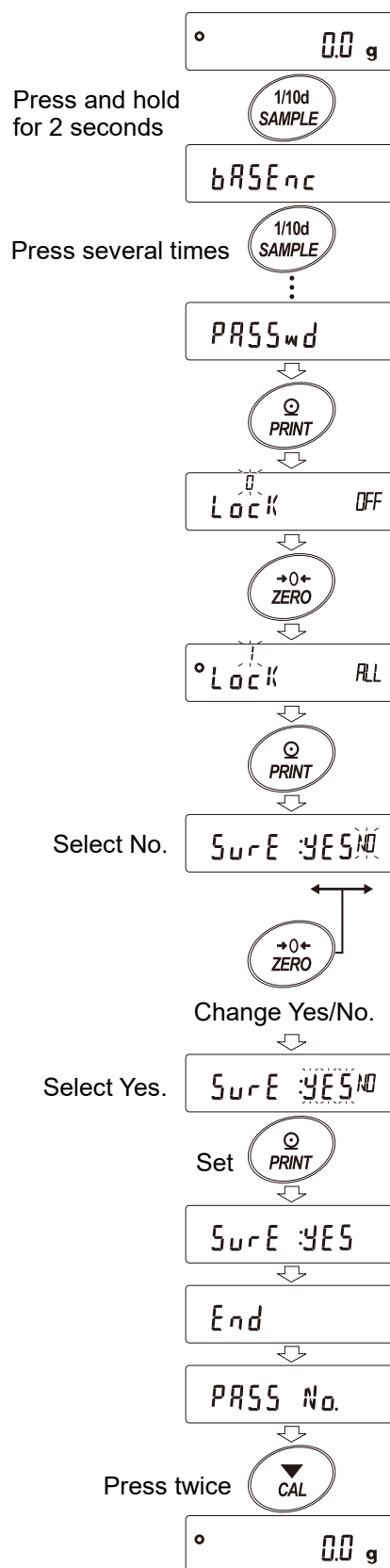

16-2. Entering a password at the start of weighing

Lock 1 (Password entry required at the start of weighing)

1. With the display turned off, press the **ON:OFF** key.
2. After **PASSword** is displayed, the password input display **---- PW** appears.
3. Enter a 4-digit password using the following keys. Note that the display will turn off after 10 minutes of inactivity.

MODE key Enters " M "
SAMPLE key Enters " 5 "
PRINT key Enters " P "
ZERO key Enters " 7 "
CAL key Back key

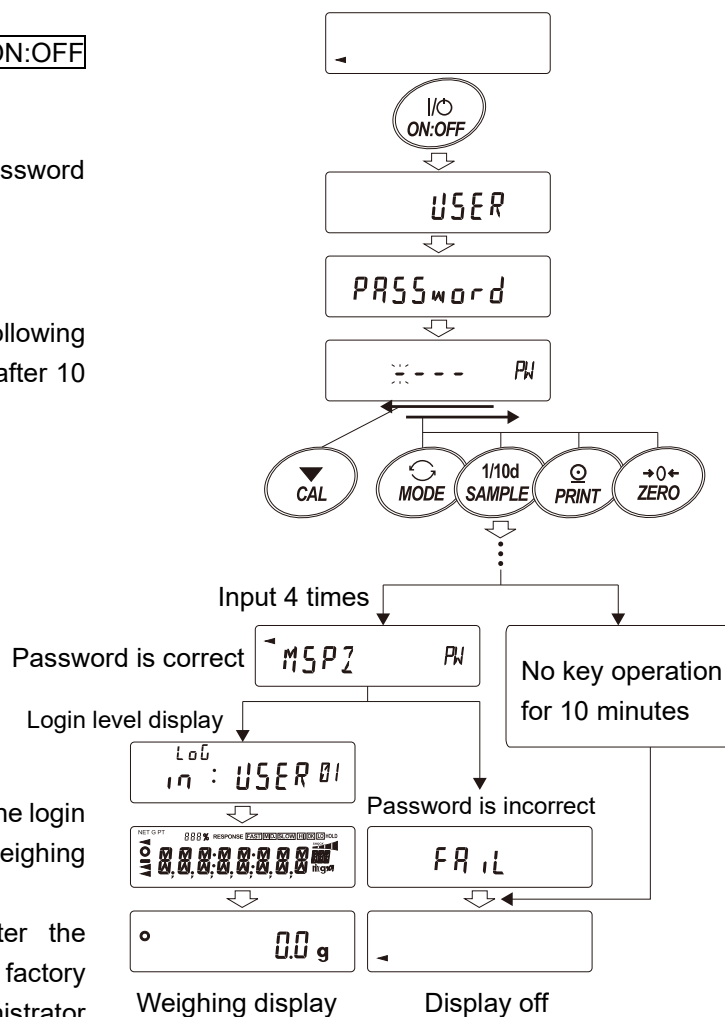

4. When the correct password is entered, the login level, all segments and indicators, and weighing display are displayed in order. To log in as the Administrator, enter the password of the Administrator. (The factory default password is set at the Administrator level, which is set by pressing the **ZERO** key four times [7777].) If the password is incorrect, **FAIL** is displayed and the buzzer sounds three times, and then the display turns off.

Lock 2 (Login with the password of the Administrator when changing the settings)

To log in as a guest (**GUEST**)

1. With the display turned off, press the **ON:OFF** key.
2. After **LOG IN : GUEST** appears, the display shifts to weighing display.

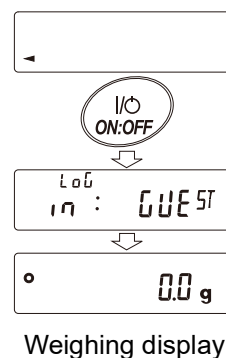

To login as the Administrator (ADMIN) (Lock 1 or 2)

1. With the display turned off, press the **ON:OFF** key while pressing and holding the **CAL** key.

2. Enter a 4-digit password using the following keys.

Note that the display will turn off after 10 minutes of inactivity.

- MODE** key Enter " M "
- SAMPLE** key Enter " 5 "
- PRINT** key Enter " P "
- ZERO** key Enter " 7 "
- CAL** key Back key

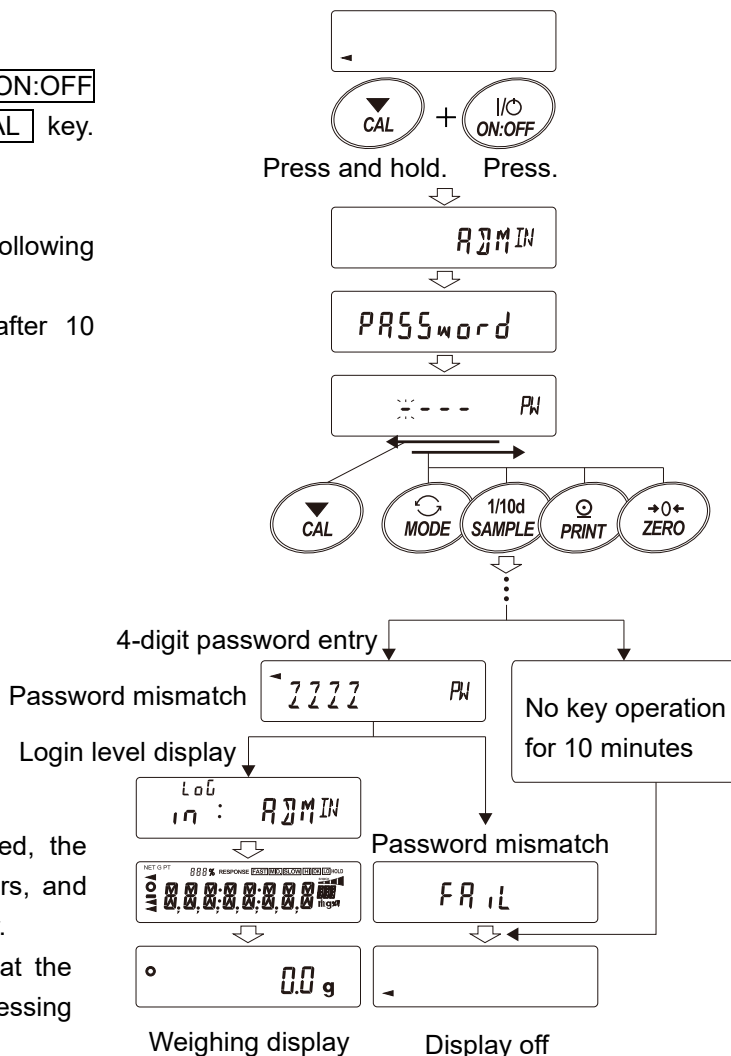

3. When the correct password is entered, the login level, all segments and indicators, and weighing display are displayed in order.

(The factory default password is set at the Administrator level, which is set by pressing the **ZERO** key four times **7777**.)

If the password is incorrect, **FAIL** is displayed and the buzzer sounds three times, and then the display turns off.

16-3. Logging out

1. You can log out by pressing the **ON:OFF** key to turn off the display.

With the " Lock 1 " setting, you will be prompted to enter the password again at the start of weighing when the display is turned off.

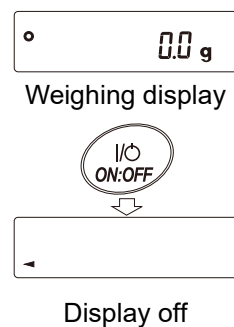

16-4. Registering (changing) password

The password can be changed with "Password (*PASS No.*)" of the function table.

1. In weighing mode, press and hold the **SAMPLE** key for 2 seconds to display **bRSEnc**.
2. Press the **SAMPLE** key several times until **PASSwd** appears.
3. Press the **PRINT** key to display **Lock**.
4. Press the **SAMPLE** key to display **PASS No.**.
5. Press the **PRINT** key to display the login level (**ADMIN**).
6. Press the **SAMPLE** key to select the login level (**ADMIN / USER 01 to 10**) that you want to change. If the login level has a registered password already, the stability indicator lights. (It is possible to change.)
7. Press the **PRINT** key to change the password. Refer to "16-5. Changing password".

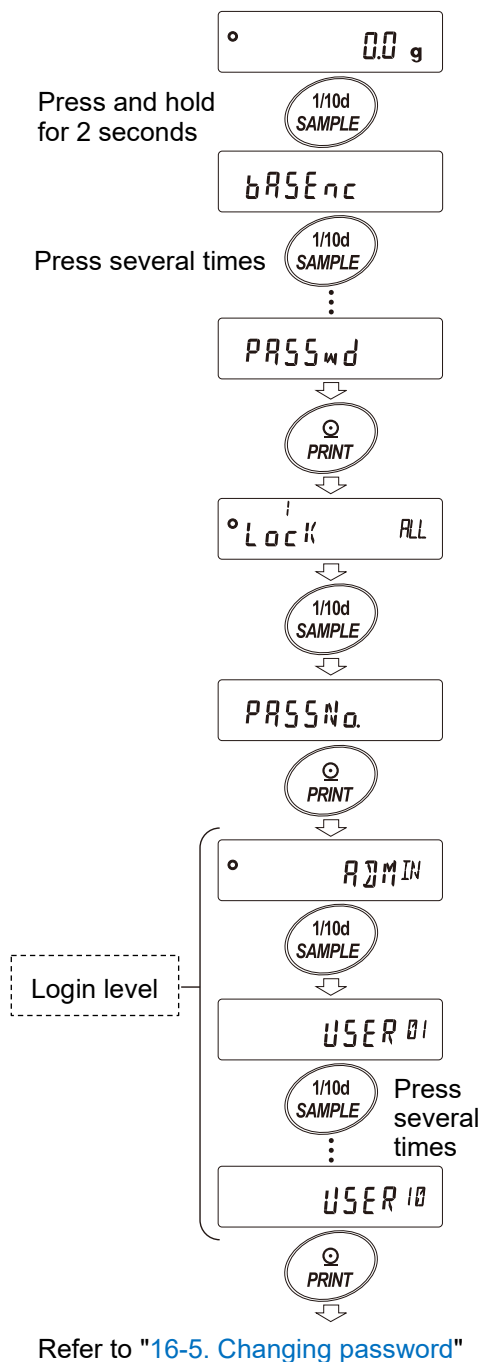

Caution

- You can log out by pressing the **ON:OFF** key to turn off the display.
- When setting "Lock 2", the password of the administrator (**ADMIN**) is required to login as the Administrator.
Password registration for "USER 01 to 10" is not necessary.

16-6. Deleting password (USER 01 to 10)

1. Refer to "16-5. Changing password" to select the user (USER 01 to 10) whose password you want to delete and display the password entry display.
2. When entering the password, press and hold the **CAL** key for 2 seconds to display **CLEAR** blinking.
3. Press the **PRINT** key to display **CLEAR No**.
4. Press the **ZERO** key to toggle between "Go" and "No".
5. With **CLEAR Go** displayed, press the **PRINT** key. **End** appears and the password is deleted.

Refer to "16-5. Changing password"

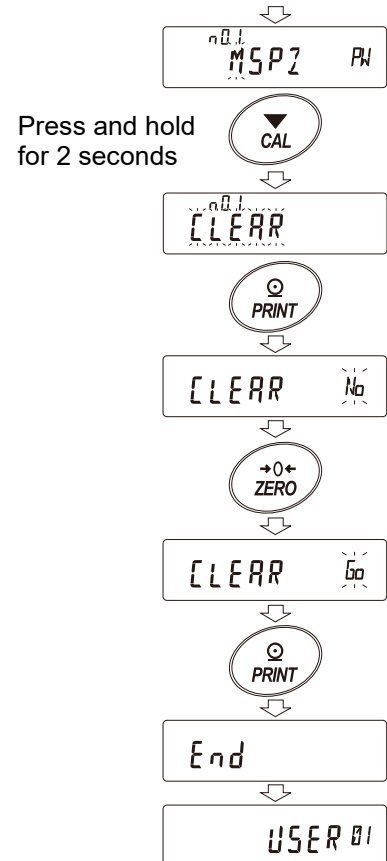

Caution

- The administrator password cannot be deleted. Refer to "16-4. Registering (changing) password" and "16-5. Changing password" to change it to an arbitrary password.

16-7. If password is lost or forgotten

If the password is lost or forgotten, the balance cannot be used.

To unlock the password, the balance must be sent to the manufacturer and repaired. Please ask your local A&D dealer for repair.

17. Repeatability Check Function (GX-L series only)

Repeatability is an index of variation in measured values when the same weight is repeatedly loaded and unloaded, and is usually expressed as the standard deviation (σ_{n-1}). The GX-L series has an internal weight.

With the repeatability check function, the balance obtains 10 measurement results using the internal weight and displays its standard deviation. It is possible to use this function with the installed balance in order to check the repeatability in the installation environment.

e.g.: "Standard deviation = 0.1 g" shows that the results of repeated measurements of the same sample fall within the range of ± 0.1 g with a frequency of about 68%.

In weighing mode, press and hold the **SAMPLE** key for 4 seconds. Release the key when **rEP tESE** is displayed.

- When **rEP tESE** is displayed, data collection starts automatically.

rEP blinks while data is being collected. To cancel it, press the **CAL** key. **CANCEL** appears and the balance returns to weighing mode.

- When data collection is completed, repeatability (standard deviation) is displayed.

- Press the **PRINT** key to output repeatability (standard deviation).

- Press the **CAL** key or **MODE** key to return to weighing mode.

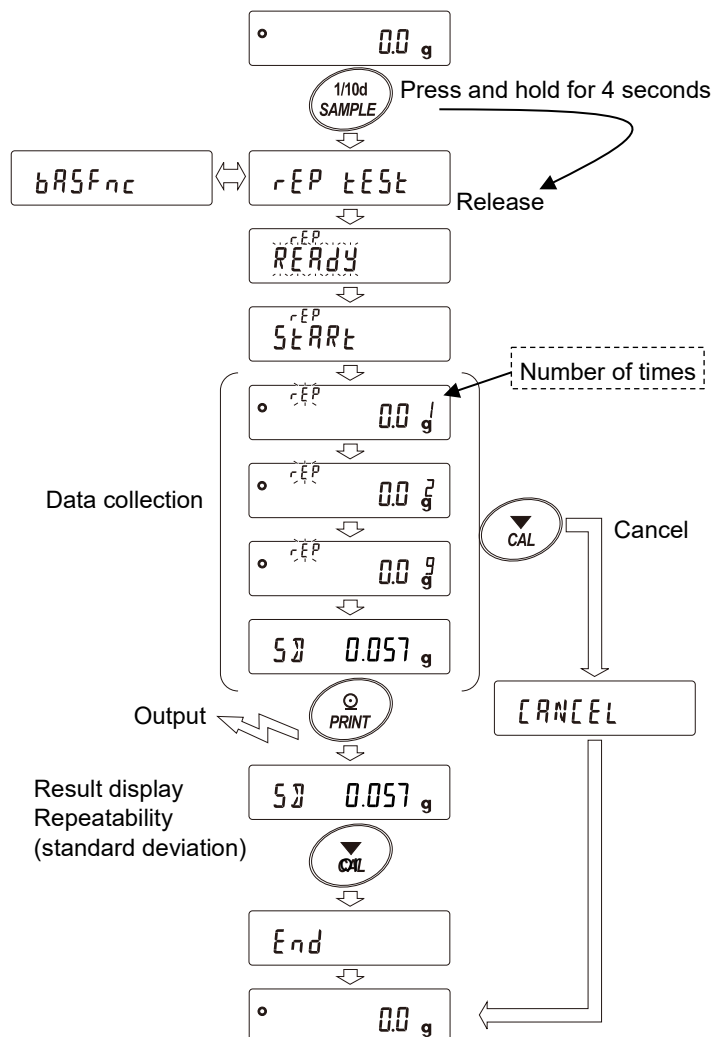

Caution

- With this function, the balance uses its internal weight (about 1 kg) in order to obtain results, which is different from the conditions for repeatability in "23. Specifications". Consider the result as a reference value.
- In order to measure correct data, do not apply vibration or drafts while collecting data.
- When the password lock function is used, this function is only available with a login as the Administrator (**ADMIN**).

18. Interface Specifications

18-1. RS-232C

Connector	D-Sub 9-pin (male)		
Transmission system	EIA RS-232C		
Transmission form	Asynchronous, two-way		
Data transmission rate	Approx. 5 times per second (5.21 Hz), approx. 10 times per second (10.42 Hz), approx. 20 times per second (20.83 Hz) (Linked with the function table " <i>bR5Fnc / 5Pd</i> ".)		
Signal format	Baud rate	600, 1200, 2400, 4800, 9600, 19200, 38400bps	
	Data bits	7 or 8 bits	
	Parity	EVEN or ODD	(Data bit length 7 bits)
		NONE	(Data bit length 8 bits)
	Stop bits	1 bit	
	Code	ASCII	

Format of 1 character (Data bit length 7 bits)

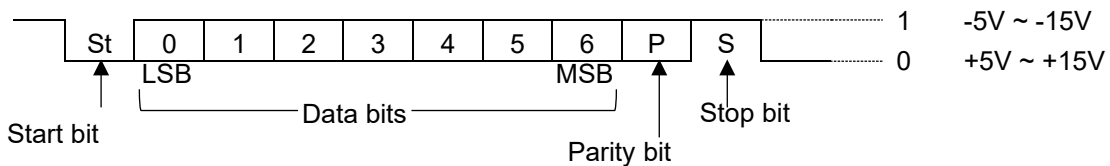

D-Sub 9, pin arrangement

Pin No.	Signal name	Direction	Meaning, remarks
1	-	-	N.C. (same potential with SG) *1
2	TXD	Output	Transmitted data
3	RXD	Input	Received data
4	-	-	N.C.
5	SG	-	Signal ground
6	DSR	Output	Data Set Ready
7	RTS	Input	Request to Send
8	CTS	Output	Clear to Send
9	-	Output	N.C. (12V Output) *1

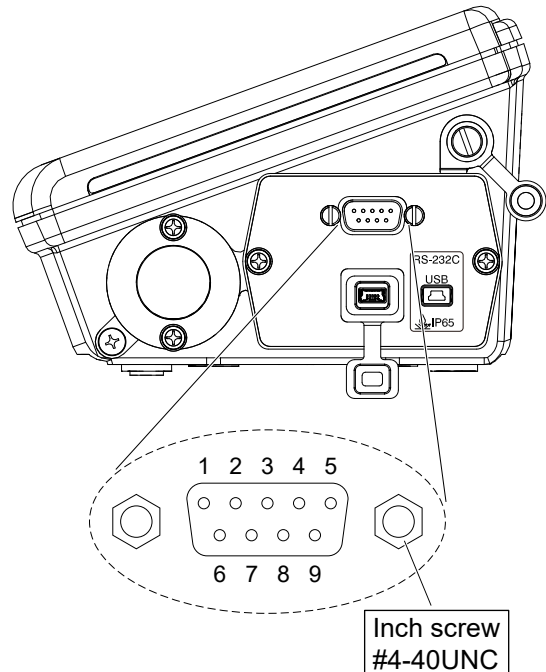

The signal name is the name of the DTE side except for TXD and RXD.
Connection diagram (when connecting to a PC)

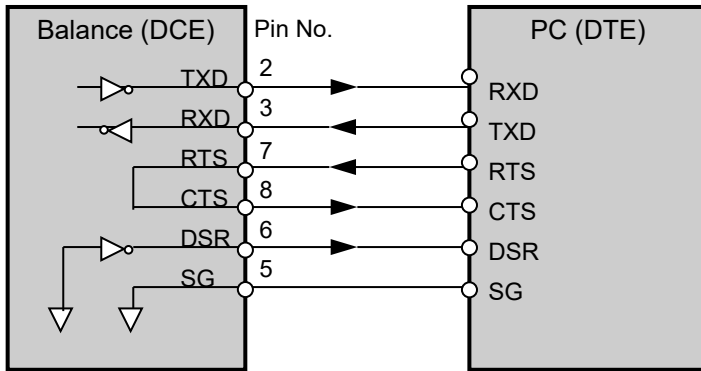

- *1 For use with some A&D products.
Do not connect the cables to other manufacturers' products such as a PC and PLC.
Using the wrong connection cable may damage the device. Be sure to check the compatible cable.

18-2. USB

Connector	Mini B (female)	
Standard	USB 2.0	
Device class	HID (Human interface device):	Quick USB
	CDC (Communication device class):	Virtual COM

Mini B, pin arrangement

Pin No.	Signal name	Direction	Meaning, remarks
1	VBUS	Input	Power
2	D-	-	Data transmission and reception
3	D+	-	Data transmission and reception
4	ID	-	N.C.
5	GND	-	Signal ground

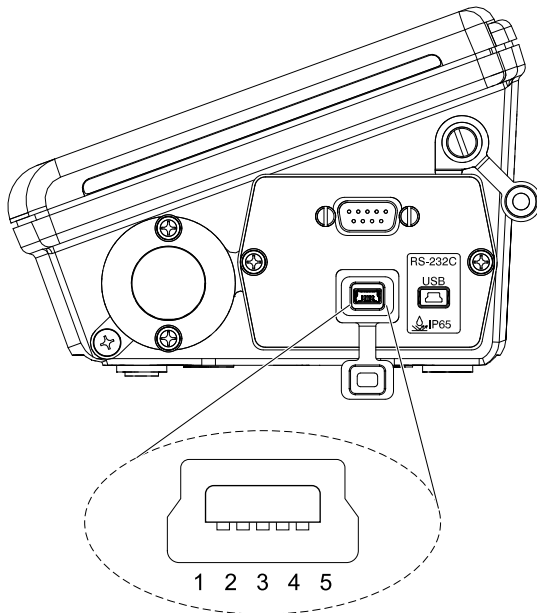

19. Maintenance

19-1. Treatment of the balance

The dustproof and drip-proof specifications of this product are waterproof for daily use, which allows the pan to be washed in water while installed.

Note that if the balance is submerged in water or used in such a way that water pressure is applied to the bottom of the balance body, water may enter the interior of the balance.

- ❑ When cleaning the balance, wipe it with a lint free cloth that is moistened with a little neutral detergent.
- ❑ Do not use organic solvents or chemical cleaning cloths to clean the balance.
- ❑ Do not disassemble the balance.
- ❑ When transporting the balance, use the packing material and box that the balance was contained at the time of purchase.
- ❑ Install the weighing pan on the main unit when washing the balance with water. For separate type models, attach the cable for connecting the main unit and display unit. Attach the terminal cover or a waterproof cable (AX-KO2737-500) to the RS-232C. Also close the AC adapter cap and USB terminal cap.
- ❑ When washing the balance with water, keep the weighing pan on it to prevent water from getting on the air-permeable filters.
- ❑ When washing with warm water, condensation may occur. Be careful not to allow water vapor to get inside.

CAUTION
For dustproof and drip-proof performance, install the weighing pan.

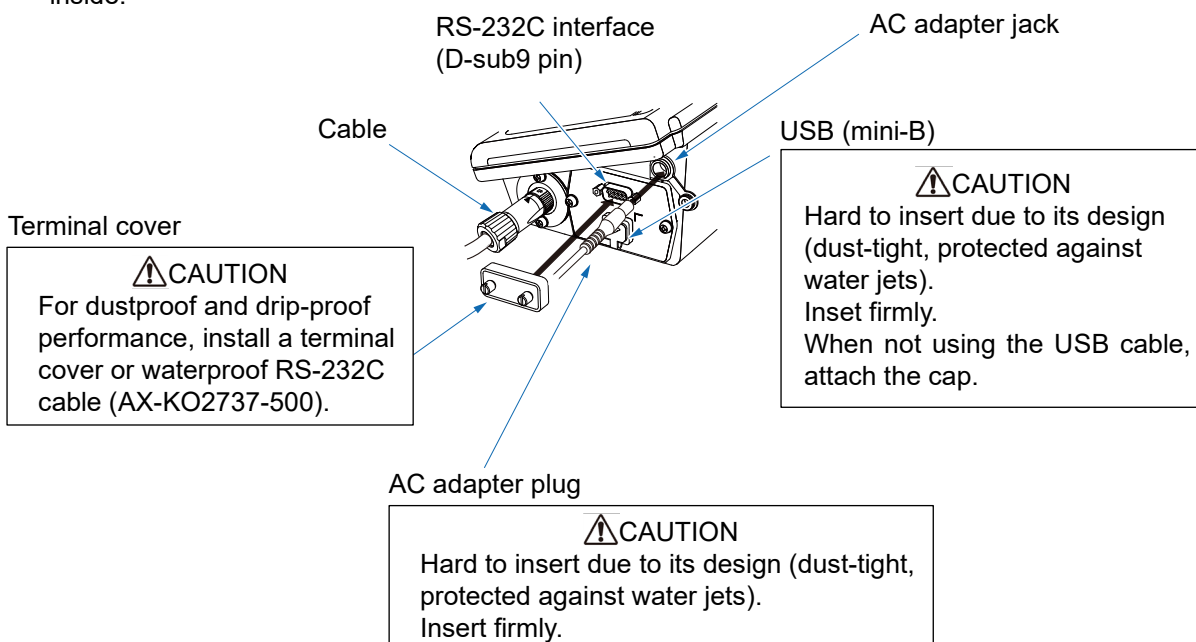
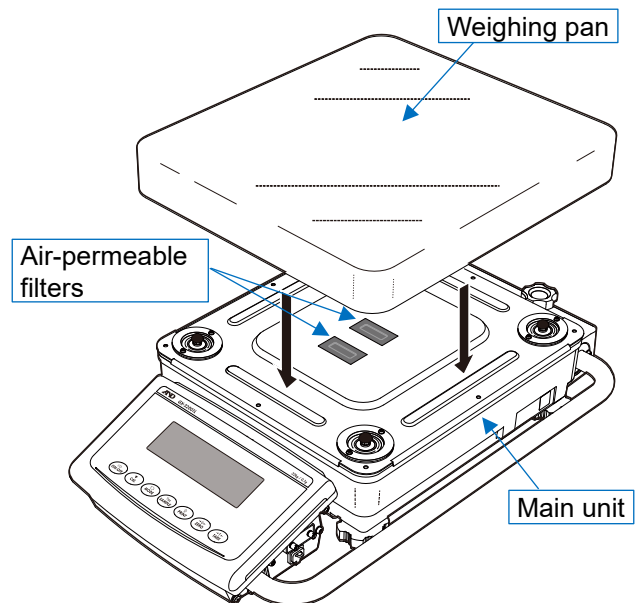

20. Troubleshooting

20-1. Checking the balance performance and environment

Since the balance is a precision instrument, in some cases it may not be able to measure correct values due to adverse effects of the measurement environment or measurement method.

If repeatability is poor when the sample is loaded and unloaded several times, or if the balance seems to be operating abnormally, check the following items. If the problem persists after checking each item, contact your local A&D dealer for repair.

"Frequently Asked Questions" and answers to them are also posted on our website (<https://www.aandd.jp>).

1. Checking that the balance works properly.

- Check the operation of the balance using the self check function. Refer to "6-2. Self check function / automatic setting of minimum weight with ECL".
A message will be displayed if there is a fatal failure.
- As a simpler test, check the repeatability with an external weight.
Be sure to place the weight in the center of the weighing pan.
- As a precise test, check the repeatability, linearity, weighing value, etc. with a weight of a known weight.

2. Check that the measurement environment and method are appropriate.

Check each item below.

Operating environment

- Is the weighing table solid enough?
- Is the balance level? For how to adjust the bubble spirit level, refer to "2-2. Precautions before use (Installation considerations and preparation)".
- Is the operating environment free from vibration and drafts?
- Is there any strong electrical or magnetic noise source such as a motor near the balance?

Weighing method

- Is the weighing pan set so that it does not touch other parts such as the breeze break and dust plate frame? (Is it installed correctly?)
- Do you always press the **ZERO** key or **TARE** key before placing your sample on the weighing pan?
- Do you place your sample in the center of the weighing pan?
- Did you perform a sensitivity adjustment before weighing? (GX-L only)
- Did you connect the balance to the power supply for at least 1 hour to warm up before weighing?





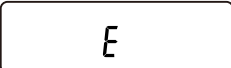
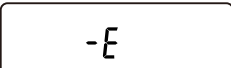
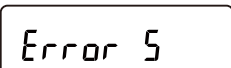
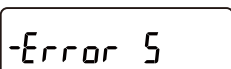
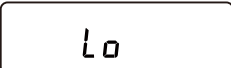
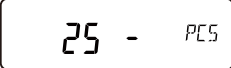
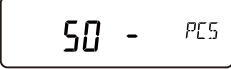
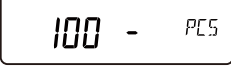
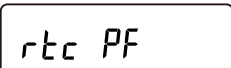
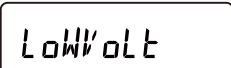

Sample and container

- Is the sample free from moisture absorption or evaporation due to the influence of ambient temperature and humidity?
- Is the temperature of the container of the sample acclimatized to the ambient temperature? Refer to "2-3. Precautions during use (for more accurate weighing)".
- Is the sample free of static electricity? Refer to "2-3. Precautions during use (for more accurate weighing)".
- Is the sample a magnetic material (iron, etc.)? Care must be taken when weighing magnetic materials. Refer to "2-3. Precautions during use (for more accurate weighing)".

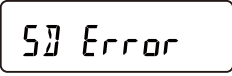
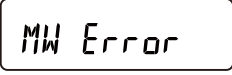
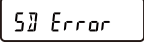
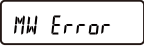
20-2. Error displays (error codes)

Display	Code	Description and possible countermeasure
Error 0		Internal error If this error continues to be displayed, please contact your local A&D dealer for repair.
Error 1	EC, E11	Stability error Weighing value is unstable and therefore the "zero display", "sensitivity adjustment", etc. cannot be executed. Check around the pan. Refer to "2-3. Precautions during use (for more accurate weighing)". Improve the environment of the installation location to prevent factors such as vibration, draft, and static electricity from influencing the balance. To clear the error and return to weighing display, press the CAL key
Error 2		Out of the setting range The value to be set exceeds the setting range. Set again within the setting range.
Error 3		Malfunction of the internal memory element of the balance If this error continues to be displayed, please contact your local A&D dealer for repair.
Error 6	EC, E16	Internal weight error (GX-L series only) Applying the internal weight does not yield a change in the mass value as specified. Confirm that there is nothing on the pan and perform the operation from the beginning. If there is no improvement, please contact your local A&D dealer for repair.
Error 7	EC, E17	Internal weight error (GX-L series only) The internal weight application mechanism does not function properly. Perform the operation from the beginning again. If there is no improvement, please contact your local A&D dealer for repair.
Error 8		Abnormality in the internal memory data of the balance If this error continues to be displayed, please contact your local A&D dealer for repair.
Error 9		Abnormality in the internal memory data of the balance If this error continues to be displayed, please contact your local A&D dealer for repair.
CAL E	EC, E20	Sensitivity adjustment weight error (Positive value) The sensitivity adjustment weight is too heavy. Check around the pan. Check the mass value of the weight. To return to the weighing mode, press the CAL key.
-CAL E	EC, E21	Sensitivity adjustment weight error (Negative value) The sensitivity adjustment weight is too light. Check around the pan. Check the mass value of the weight. To return to weighing mode, press the CAL key.

Display	Code	Description and possible countermeasure
		Overload error A sample beyond the balance weighing capacity has been placed on the pan. Remove the sample from the pan. If there is no improvement, please contact your local A&D dealer for repair.
		Weighing pan error The weighing value is too light. Check that the weighing pan is installed correctly. Set the weighing pan correctly. Adjust the sensitivity of the balance.
		Overload error A sample beyond the balance weighing capacity has been placed on the pan. Remove the sample from the pan. If there is no improvement, please contact your local A&D dealer for repair.
		Weighing pan error The weighing value is too light. Check that the weighing pan is installed correctly. Set the weighing pan correctly. If there is no improvement, please contact your local A&D dealer for repair.
		Sample weight error The sample is too light to be stored as a sample weight for the counting mode or percent mode. It cannot be used as a sample.
  		Unit weight error The sample unit weight for the counting mode is too light. Storing and using it for counting will cause a counting error. Add samples to reach the specified number and press the PRINT key. Pressing the PRINT key without adding samples will put the balance in the counting mode. But, for accurate counting, be sure to add samples.
		Clock battery error The clock backup battery has been depleted. Press any key and set the time and date. Even if the clock backup battery is depleted, the clock and calendar function works normally as long as the balance is powered with the AC adapter. Please contact your local A&D dealer for repair if this error appears frequently.
		Power supply voltage fault The voltage supplied from the AC adapter is abnormal. Please check if the problem is the AC adapter supplied with the balance.

Display	Code	Description and possible countermeasure
 		<p>ECL repeatability error With the self-check function, the standard deviation (SD) of repeatability with electronically controlled load (ECL) exceeded 50 d*1. Review the installation environment of the balance.</p> <ul style="list-style-type: none"> <input type="checkbox"/>  Repeatability error <input type="checkbox"/>  Minimum weight (reference value) error Refer to "6-2. Self check function / automatic setting of minimum weight with ECL".
 ↑ Blinking (alternately) ↓ 		<p>Full memory The number of stored weighing values has reached the upper limit. To store new weighing values, it is necessary to delete data. Refer to "11. Data Memory".</p>
 ↑ Blinking (alternately) ↓ 		<p>Full memory The number of stored sensitivity adjustment/calibration test histories has reached 50. When new histories are added, older histories will be deleted. Refer to "11. Data Memory".</p>
		<p>Level check Check the bubble spirit level on the main unit of the balance. Adjust the level so that the bubble is inside the center circle of the bubble spirit level. Alternatively, press any key other than the  key to cancel the display.</p>
	EC, E00	<p>Communications error A protocol error occurred in communications. Check the format, baud rate, etc.</p>
	EC, E01	<p>Undefined command error An undefined command was found. Check the transmitted command.</p>

*1 "d" (readability digit) is the unit of readability.

E.g. If the readability is 0.1 g, 1 d is 0.1 g. (50 d is 5.0 g)

Display	Code	Description and possible countermeasure
	EC, E02	<p>Not ready</p> <p>The received command cannot be executed.</p> <p>E.g.: Q command was received when not in weighing mode.</p> <p>E.g.: Q command was received while re-zeroing.</p> <p>Adjust the delay time to transmit a command.</p>
	EC, E03	<p>Timeout error</p> <p>With the timeout parameter set to $\overset{1}{\text{°E-UP}} \text{ 1SEC}$, there was a wait time of approximately 1 second or more while receiving command characters. Check the communication.</p>
	EC, E04	<p>Character length error</p> <p>The number of characters in the received command has exceeded the limit. Check the command to transmit.</p>
	EC, E06	<p>Format error</p> <p>The description of the received command is incorrect.</p> <p>E.g.: The number of digits of numerical values is incorrect.</p> <p>E.g.: There are alphabet characters among the numerical values</p> <p>Check the transmitted command.</p>
	EC, E07	<p>Parameter setting error</p> <p>The value of the received command has exceeded the allowed value.</p> <p>Check the setting range of the numerical value of the command.</p>
	Other errors	<p>If the errors described above cannot be released or other errors are displayed, please contact your local A&D dealer.</p>

20-3. Other display



This is the automatic sensitivity adjustment notice (the ◀ mark blinking). If the balance is not used for several minutes with this mark blinking, the balance automatically performs sensitivity adjustment using the internal weight. (The blinking period depends on the operating environment.)

Tip Although it is possible to continue using the balance even while this mark is blinking, use after sensitivity adjustment is completed is advisable in order to maintain the weighing accuracy.

20-4. Asking for repair

If the balance needs service or repair, please contact your local A&D dealer. The balance is a precision instrument. Use much care when handling the balance and observe the following when transporting the balance.

- Use the original packing material for transportation.
- Remove the weighing pan and pan support from the main unit when transporting the balance.

21. Connecting Peripheral Devices

It is possible to connect the balance to peripheral devices, PCs, PLCs, etc. by using the RS-232C connector and the USB mini B connector which are provided as standard with the balance.

21-1. Cables needed to connect to peripheral devices

Connection cables for peripheral devices and interfaces are as follows.

Connection cables for peripheral interface

Name	Model	Communication interface	Connection cables		Note
			Standard / Option Model	Model	
Multi-functional compact printer	AD-8127	RS-232C	[Standard] RS-232C cable included with the printer.	AX-K02741-100	*1
Remote display	AD-8920A	RS-232C	Communication cable included with remote display or remote controller.	AX-K03412-100	*2
Remote controller	AD-8922A			AX-K02466-200	*2
Extension controller for weighing lines	AD-8923-BCD		[Option]	AX-K02466-200	
	AD-8923-CC				
PLC		[Option]		*3	
PC		RS-232C	[Option]		*4
		USB	[Standard] USB cable included with the balance.	AX-K05465-180	

Note

- *1 When using the AD-8529PR-W (Bluetooth® converter) sold separately, the RS-232C cable included with the printer is not used.
- *2 There is also a 5m / 10m cable sold separately.
- *3 Check the interface specifications of the GX-L / GF-L and the PLC used and prepare a compatible cable.
- *4 The balance can be connected to a PC using AX-USB-9P, AD-8529PC-W, AD-1688, and AD-8527.
The connection cable included with these products can be used for data transfer.

21-2. About data output method

Change the function of the balance to make the operation method that which is suitable for use with the balance. Refer to “9. Function Table” for details of the function.

- 1) The weighing data output method using the RS-232C / USB interface can be specified in the “Data output mode (*Prt*)”.

. Data output mode

Class	Item	Parameter	Description
<i>dout</i>	<i>Prt</i> Data output mode	0	Key mode Outputs if stable when <input type="button" value="PRINT"/> key is pressed.
		1	Auto print mode A Automatically outputs after stabilization (zero is the reference).
		2	Auto print mode B Automatically outputs after stabilization (based on previous stable value).
		3	Stream mode Continuously outputs
		4	Key mode B Immediately outputs regardless of being stable or unstable when <input type="button" value="PRINT"/> key is pressed.
		5	Key mode C When <input type="button" value="PRINT"/> key is pressed, outputs immediately if stable, outputs after stabilization if unstable.
		6	Interval mode Starts output with <input type="button" value="PRINT"/> key, outputs at time of setting.
		7	Auto print mode C Outputs data when stable beyond the range of <i>RP-P</i> and <i>RP-b</i> from the zero point and the weighing value is stable with an <input type="button" value="OK"/> result.

- 2) Precautions when connecting multiple peripheral devices at the same time.

Peripheral devices such as the remote display, remote controller, and extension controller for weighing lines shown in the table display the weighing value in real time. So, the balance is normally operated in a continuous output mode (stream mode).

On the other hand, if the balance is set to stream mode, it may be difficult to use when connecting a peripheral device such as a printer, PLC, and PC. In order to connect peripheral devices operated in stream mode and another at the same time, the function table “ *ModE* ” enabling RS-232C to operate exceptionally according to the connected peripheral device is provided.

Function table “ *ModE* ”

Class	Item	Parameter	Description	Data output mode	
				Data output mode	Data format
<i>SIF</i>	<i>ModE</i> Devices connected to standard RS-232C	0	PC, PLC, etc.	Follow <i>dout Prt</i> setting	Follow <i>SIF TYPE</i> setting
		1	Printer	Follow <i>dout Prt</i> setting	Follow <i>SIF TYPE</i> setting (A&D standard, DP only selectable)
		2	Remote display, etc.	Regardless of <i>dout Prt</i> , enter stream mode	Regardless of <i>SIF TYPE</i> output with A&D standard format *1

- *1 Only the weighing value is output continuously. Date, time (*Prt / S-td*), ID number (*Prt / S-id*) are not added, and data output interval (*PUSE*) auto feed (*RL-F*), GLP output (*INFa*) functions cannot be used.

21-3. Specific examples when connecting multiple peripheral devices at the same time

[1] Connecting to a printer and PC

Example of use) Outputs the weighing value to the printer and imports the weighing value at the same time.

Example of simultaneous connection settings [1] "Printer and PC"

Connection method		Function compatible with connection interface / connected device			
Interface	Connected device	Class	Item	Parameter	Contents
(Common setting)		<i>dout</i>	<i>Prt</i>	0-6	Select the data output mode suitable for the usage / settings of the printer / PC *1
RS-232C	Printer	<i>SIF</i>	<i>ModE</i>	1	Select the data output format suitable for the settings / usage of the printer (A&D standard format, DP format)
			<i>TYPE</i>	0,1	
USB	PC	<i>USB</i>	<i>U-TP</i>	0-4	Select an output format that is easy for your PC to handle.

*1 The data output mode is common to the printer and PC.

Dedicated printer for balances is the AD8127 compact printer.

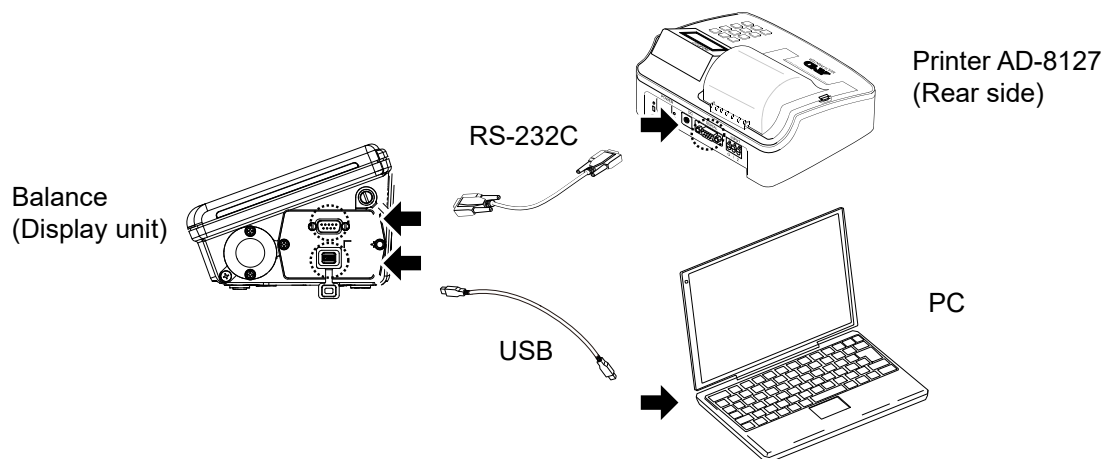
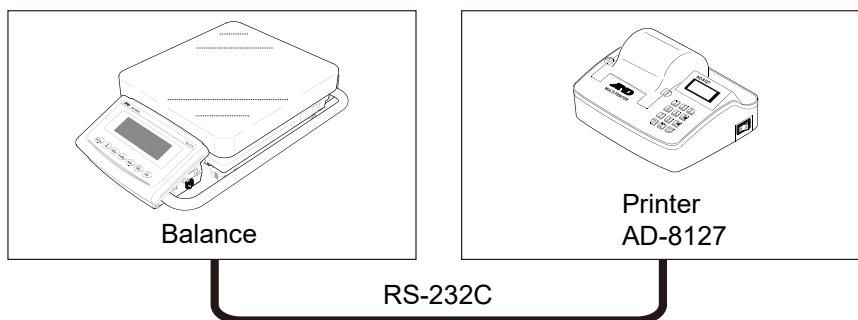

If only the balance is connected to the PC, it can also be connected using a USB cable or RS-232C cable.

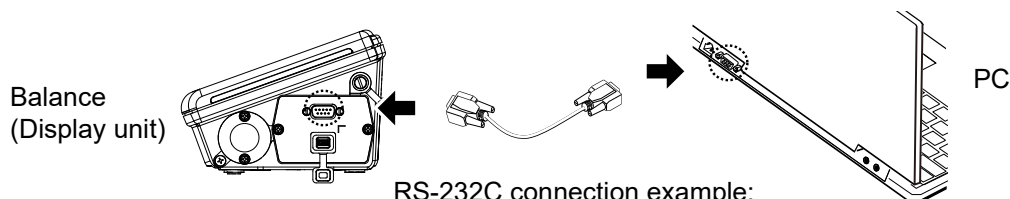

RS-232C connection example:
If the PC does not have an RS-232C interface (COM port),
a USB converter (AXUSB-9P) can be used.

[2] Connection between printer and remote display

Example of use) Print the weighing value on the printer while displaying the measured value on the remote display.

Example of simultaneous connection settings [2]” Printer and external display, etc.”

Connection method		Function compatible with connection interface / connected device			
Interface	Connected device	Class	Item	Parameter	Contents
RS-232C	Printer	<i>dout</i>	<i>Prt</i>	0-6	Select the data output mode suitable for the settings / usage of the printer
		<i>Sif</i>	<i>ModE</i>	1	Select the data output format suitable for the settings / usage of the printer (A&D standard format, DP format)
	<i>TYPE</i>		0,1		
USB	[None]				

Connect a remote display dedicated to the balance when checking the weighing value or performing key operations at a distance from the balance.

Dedicated remote displays for balances are the AD-8920A external display (display only) and AD-8922A remote controller.

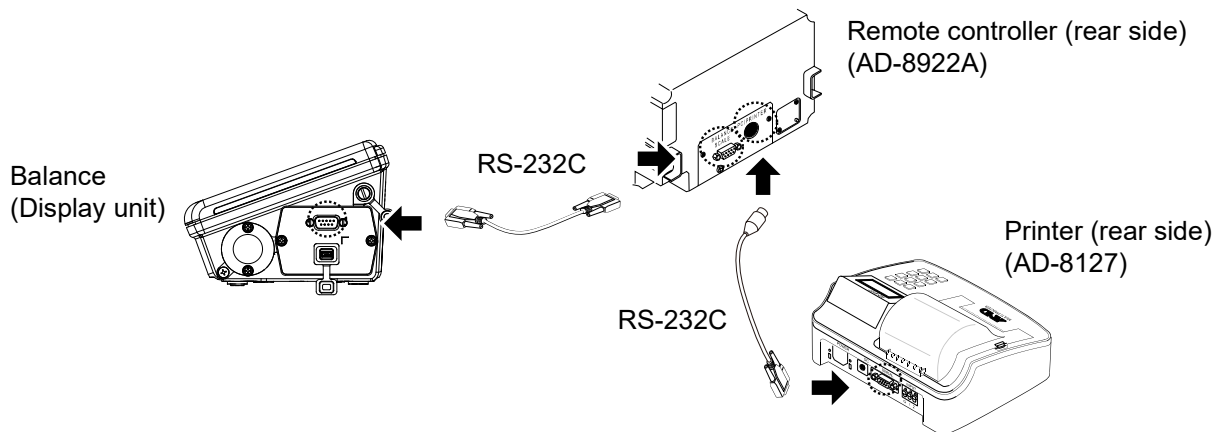
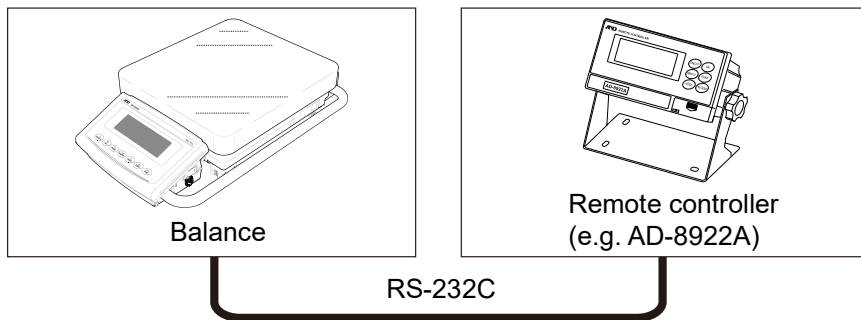

[3] Connection between a remote display and PC

Example of use) Logging the weighing value on the PC while displaying the weighing value on the remote display.

Example of simultaneous connection settings [3] [External display and PC]

Connection method		Function compatible with connection interface / connected device			
Interface	Connected device	Class	Item	Parameter	Contents
RS-232C	Remote display	<i>Sif</i>	<i>ModE</i>	2	Weighing values are continuously output to the remote display in A&D standard format.
USB	PC	<i>dout</i>	<i>Prt</i>	0-6	Select data output mode suitable for PC logging method.
		<i>U5b</i>	<i>U-tP</i>	0-4	Select an output format that is easy for your PC to handle.

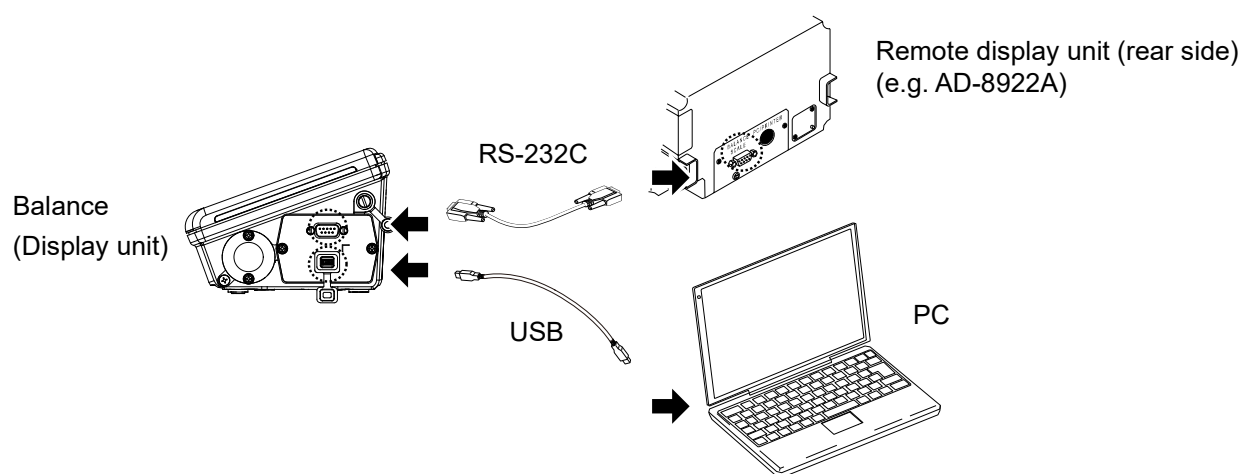

21-4. Printing weighing values to the printer

The following shows examples of the balance's function and printer settings corresponding to the type of printer used and the printing method such as weighing value.

21-4-1. AD-8127 multi-functional compact printer

1) When printing only weighing value

Balance common settings when printing only weighing values on the AD-8127

Class	Item	Parameter	Contents
S, F	MODE	1	Printer connection
	TYPE	0	A&D standard format

Settings when printing only weighing values on the AD-8127

Weighing value printing method	Settings of the balance		Settings of AD-8127	
	dout / Prt	Contents	PRN .MODE	Contents
Print the weighing value when the [PRINT] key on the balance is pressed.	0	Key mode (when stable)	EXT.KEY	External key printing mode
	4	Key mode B (immediately) *1		
	5	Key mode C (after stabilization)		
Automatically print the weighing value when the weighing value changes.	1	Auto print mode A (zero reference)		
	2	Auto print mode B (previous stabilization reference)		
	7	Auto print mode C (when comparator is OK)		
Print the weighing value at regular intervals.	6	Interval mode *1		
Print the weighing value when the printer's [PRINT] key is pressed.	3	Stream mode *1	MANUAL	Manual printing mode
Print the weighing value in chart format.	3	Stream mode *1	CHART	Chart printing mode

*1 Unstable data is also output.

When setting the AD-8127 to a mode other than dump printing mode and also printing unstable data, change the function of the AD-8127 to "Setting to print unstable data (US PRN/PRINT)"

2) When adding date/time or ID number, etc. to the weighing value with the clock function of the balance.

Common settings for the balance when printing with information in addition to the weighing value added to the AD-8127

Class	Item	Parameter	Contents
5,F	Mode	1	Printer connection
	TYPE	1	DP format

Common settings for the balance when printing with information in addition to the weighing value added to the AD-8127

Weighing value printing method	Function of the balance		AD-8127 Function	
	dout / Prt	Contents	PRN .MODE	Contents
Print the weighing value when the PRINT key on the balance is pressed.	0	Key mode (when stable)	DUMP	Dump printing mode
	4	Key mode B (immediately) *1		
	5	Key mode C (after stabilization)		
Automatically print the weighing value when the weighing value changes.	1	Auto print mode A (zero reference)		
	2	Auto print mode B (previous stabilization reference)		
	7	Auto print mode C (when comparator is OK)		
Print the weighing value at regular intervals.	6	Interval mode *1		

Printing with printer keys and chart format printing are not possible.

3) When outputting information other than weighing values

When printing calibration / calibration test maintenance records (GLP output), or when the balance outputs statistical calculation results calculated on the balance, change the printer to dump printing mode.

AD-8127 settings when printing information other than weighing values on the AD-8127.

AD-8127 Function	
PRN .MODE	Contents / usage
DUMP	Dump printing mode

Switching the print mode (PRN MODE) of the AD-8127

When pressing and holding the [ENT_{SAVE}] key on the printer, it is possible to switch between EXT.KEY (external key mode) and DUMP (dump printing mode) without entering the AD-8127 function table.

This is useful when temporarily switching the AD-8127 to dump printing mode for GLP output, etc.

21-5. Connecting to a PC

21-5-1. Quick USB mode

Quick USB mode is a function used to connect the balance with the PC using a USB cable to directly input the output data of the balance into PC software such as Excel or Word. Windows XP or later is supported.

Since the balance uses a standard Windows driver (HID), no installation of a special driver is necessary and communication is possible just by connecting the balance to a PC.

Caution

- ❑ Quick USB is a one-way communication from the balance to the PC. It is not possible to send control commands from the PC to the balance.
- ❑ Turn off the PC's screen saver and stand-by modes.
- ❑ Do not use quick USB when the output mode of the balance is set to stream mode.
As stream mode continuously outputs weighing data to the PC from the balance, irregular operation may occur on the PC.
- ❑ Refer to "[22. Checking the software version of the balance](#)" for how to confirm the software version of the balance.

About the output format for USB

- ❑ When using USB, select the output format in the function table (*U-tP*).

Function table	Output format	Output example															
<i>U-tP</i> 0	A&D standard format	S	T	,	+	0	0	1	2	3	4	.	5	g	CR	LF	
<i>U-tP</i> 1	NU format	1	2	3	4	.	5	CR	LF								
<i>U-tP</i> 2	CSV format	S	T	,	+	0	0	1	2	3	4	.	5	,	g	CR	LF
<i>U-tP</i> 3	TAB format	S	T	TAB	+	0	0	1	2	3	4	.	5	TAB	g	CR	LF
<i>U-tP</i> 4	NU2 format	1	2	3	4	.	5	CR	LF								

␣: Space, CR: ASCII code 0Dh, LF: ASCII code 0Ah, TAB: ASCII code 09h

Refer to "[9-7. Weighing data format](#)" for details of output format.

Operating instructions (when sending weighing data using the balance's **PRINT** key)

1. Set *UFnC* 0 (Quick USB) in the function table.
2. Connect the balance to a PC with the supplied USB cable.
3. When connecting for the first time, the PC will automatically start installing the driver.
4. Start up PC software (Excel, etc.) for transmitting the weighing data.
5. Set the keyboard input mode to half-width. It is not entered correctly in full-pitch setting.
6. Move the cursor to the place you want to input the weighing data.
7. When you press the **PRINT** key on the balance, weighing data will be transmitted from the balance and input at the location of the cursor.
8. Disconnect the USB cable when finished.

21-5-2. Virtual COM mode

Virtual COM mode is a function used to connect the balance with the supplied USB cable and create a COM port on the PC side for bi-directional communication.

Windows 7 or later is supported. Except for Windows 10, when using for the first time, you need to install a special driver on the PC.

For details on how to install the driver, please refer to "How to install the Virtual COM mode driver" for the GX-A / GF-A series USB interface on our website (<http://www.aandd.jp>)

When selecting a COM port with Win CT data communication software, the same data communication as RS-232C will be available.

With Virtual COM mode, no settings for baud rate, data bits, parity and stop bits are necessary.

Caution

- It may take time to install the Virtual COM mode driver for the first time.

About the function table

- When using Virtual COM mode, please set the balance's function table " *UFnc* " to bi-directional USB virtual COM.

21-5-3. RS-232C

The RS-232C interface of the balance is the DCE (Data Communication Equipment) that can be connected to a PC. The RS-232C cable used for connection is the straight type. If there is no RS-232C connector on the PC, please connect in USB Virtual COM mode.

21-5-4. WinCT data transmission software (USB Virtual COM mode or RS-232C)

When a PC is connected through a USB connection in virtual COM mode or with a RS-232C cable, weighing data can be easily received by the PC with the use of the WinCT data communication software for Windows. WinCT can be downloaded from our website (<https://www.aandd.jp>). Please refer to "Setup manual" and "Operation manual" for WinCT on our website (<https://www.aandd.jp>) for installation and setup.

There are 3 applications in WinCT: RsCom, RsKey, and RsWeight.

RsCom

- You can control the balance by sending a command to it.
- Received data can be displayed and saved as a text file (.txt).
- By executing the software multiple times, you can communicate with multiple balances.
- It can be executed simultaneously with other applications. (Does not exclusively occupy the PC)
- GLP output data can also be received from the balance.

RsKey

- Weighing data from the balance can be input directly into another applications.
- If input by keyboard (e.g. with Word or Excel) is possible, the type of application does not matter.
- GLP output data from the balance can also be input.
- The PC can be made into an external display for the balance through the use of the test display function.

RsWeight

- Received data can be graphed in real time.
- Parameters of received data such as maximum value, minimum value, average value, standard deviation, coefficient of variation, etc. can be calculated and displayed.

21-6. Windows communication tools for parameter setting (“WinCT-ParamSet”)

- ❑ This software, “Windows Communication Tools for Parameter Setting” (“WinCT- ParamSet”), can change the internal settings of GX-L/GF-L series balances on a PC. RS-232C is used for communication with a PC. Prepare an appropriate cable to connect the PC to the balance. (e.g.: Serial / USB converter AX-USB-9P) WinCT-ParamSet can be downloaded from the "Software" page of A&D website (<https://www.aandd.jp>).
- ❑ To install and setup WinCT-ParamSet, download the software from "DOWNLOAD WINCT-PARAMSET" on A&D website and refer to:
"WinCT-ParamSet_Set_Up_JP_Ver.1.00.pdf" and "WinCT -ParamSet_Instruction_Manual_JP_Ver.1.00.pdf".
- ❑ The ID number and internal settings data can be read from the balance and changed all at once.
- ❑ The settings can be saved in CSV file format.
- ❑ The saved CSV file can be read and the settings written to the balance.

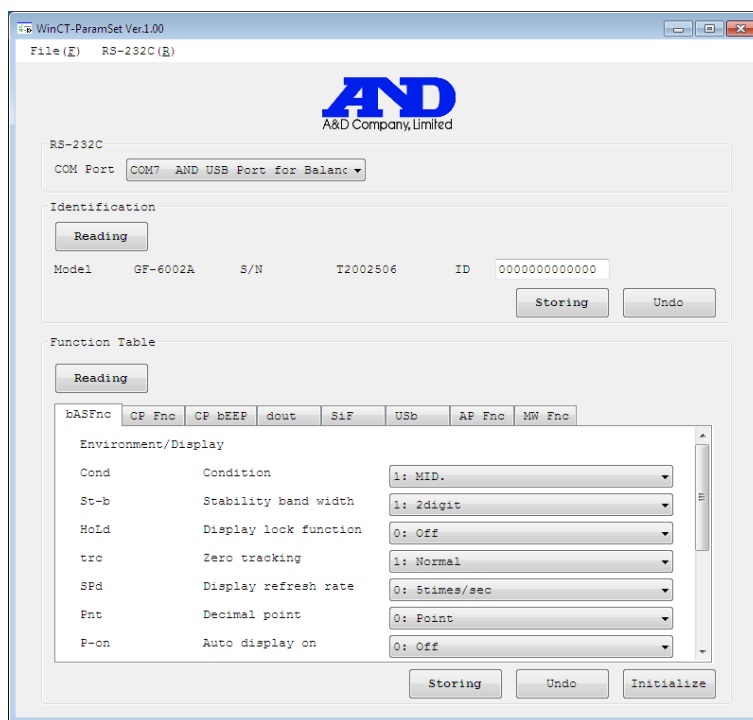

Caution

- ❑ Except for the ID settings, settings that require numerical input (e.g.: unit mass setting for piece counting) cannot be set with this software. Use the keys on the balance to set.
- ❑ This software cannot be used when the password lock function of the balance is enabled. Also, it cannot be used to change from disabled to enabled. Use the keys on the balance to set the password lock function.
- ❑ When writing the settings from a saved CSV file, the software version of the balance described in the CSV file must match the software version of the balance it will be written to.

21-7. Commands

By sending a specified command from a PC or a PLC to the balance, you can control the balance such as by requesting weighing data, manipulating various keys and changing the setting value. Add a terminator (<CR> <LF> or <CR>) to the command string by setting serial interface item τLF when you send a command to the balance.

21-7-1. Control commands

Commands to query weighing data

Command string	Function
Q	Requests the weighing data immediately.
RW	Requests the weighing data immediately.
SI	Requests the weighing data immediately.
S	Requests the weighing data when stabilized.
<ESC>P	Requests the weighing data when stabilized.
SIR	Requests the weighing data continuously. (Stream output)
C	Cancels the S, <ESC>P, or SIR command.

- The Q, RW and SI commands behave the same.
- The S and <ESC>P commands behave the same.
- <ESC> : Escape code, ASCII : 1Bh code

Key control commands

Command string	Function
P	<input type="button" value="ON:OFF"/> key
ON	Turns the display on.
OFF	Turns the display off.
CAL	<input type="button" value="CAL"/> key <ul style="list-style-type: none"> · Sensitivity adjustment with the internal weight (GX-L series) · Sensitivity adjustment with an external weight (GX-L series)
EXC	Sensitivity adjustment with the external weight (GX-L series)
U	<input type="button" value="MODE"/> key
SMP	<input type="button" value="SAMPLE"/> key
PRT	<input type="button" value="PRINT"/> key
Z	<input type="button" value="ZERO"/> key · The Z and ZR commands have the same behavior.
ZR	
T	<input type="button" value="TARE"/> key · The T and TR commands have the same behavior.
TR	
R	*1 RE-ZERO (Semi-automatic zero-point setting) *1 <ul style="list-style-type: none"> · The R and RZ commands have the same behavior.
RZ	

- *1 If it is within the zero range, the zero point is updated. If it is beyond the zero range, tare subtraction is performed.

Commands for presetting the tare value

Command string	Function
PT:****,* g	<p>Sets the tare value.</p> <p>The unit added is the unit that is output in the A&D standard format (3 characters).</p> <p>For the counting or percent mode, gram is used.</p> <p>In the case of setting the preset tare value to 1234.6 g, the input will be <u>PT:1234.6</u> g.</p> <p>Values exceeding the weighing capacity cannot be set. Negative values cannot be used.</p>
?PT	<p>Requests the tare value.</p> <p>Outputs the tare value set by the PT command.</p>

Command to control piece count

Command string	Function
UW:****,* g	<p>Sets the unit mass value (weight of 1 piece)</p> <p>The unit added is the unit that is output in the A&D standard format (3 characters).</p> <p>In the case of setting the unit mass value to 1.2 g, the input will be <u>UW:1.2</u> g.</p> <p>Values exceeding the weighing capacity cannot be set. Negative values cannot be used.</p>
?UW	Requests the unit mass value.

Commands to control the comparator function

Command string	Function
HI:****,* g	<p>Sets the upper limit value.</p> <p>Sets the second upper limit value.</p> <p>Sets the lower limit value.</p> <p>Sets the second lower limit value.</p> <p>The unit added is the unit that is output in the A&D standard format (3 characters).</p> <p>In the case of setting the upper limit value to 567.9 g, the input will be <u>HI:567.9</u> g.</p> <p>Values exceeding the weighing capacity cannot be set.</p>
HH:****,* g	
LO:****,* g	
LL:****,* g	
?HI	
?HH	Requests the second upper limit value.
?LO	Requests the lower limit value.
?LL	Requests the second lower limit value.

- To use a comparator command, set the function as follows:

Function $[P \text{ in } 0]$ (Sets upper and lower limits. Digital input) or

$[P \text{ in } 1]$ (Sets upper and lower limits. Weighing input)

Command to control the data memory function (*DATA I*)

UN:mm	<p>Changes the unit mass registration number.</p> <p>Enter a number between 01 and 50 for mm.</p>
?UN	Requests the currently selected unit mass registration number.

Command to control the data memory function (*DATA 2*)

Command string	Function
?MA	Outputs all data in memory.
?MQnnn	Outputs weighing data with the data number nnn. Input a value from 001 to 200 into nnn.
?MX	Outputs the number of weighing data in memory.
MD:nnn	Deletes weighing data with the data number nnn. Input a value from 001 to 200 into nnn.
MCL	Deletes all data in memory.

Command to control the data memory function (*DATA 3*)

CN:mm	Loads the remembered comparator. Input a value from 01 to 20 into mm.
?CN	Requests the currently selected comparator registration number.

Command to control the data memory function (*DATA 4*)

PN:mm	Loads the remembered tare value. Input a value from 01 to 20 into mm.
?PN	Requests the currently selected tare registration number.

Commands for setting time and date

Command string	Function
TM:**:**:**	Sets time. In the case of setting time to 12 h 34 min 56 sec, the input will be <u>TM:12:34:56</u> . Do not set non-existing time values.
DT:**/**/**	Sets date. In the case of setting date to June 30, 2023, the input will be <u>DT:23/06/30</u> . Do not set non-existing date values.
?TM	Requests time setting.
?DT	Requests date setting.

Commands to request other data

Command string	Function
?T	Requests the tare weight value. The tare value set by T, TR command is output.
?ID	Requests ID number.
?SN	Requests serial number.
?TN	Requests device name.
?SA	Outputs impact data all at once.

21-7-2. The <AK> code and error codes

When the function *ErEd I* (AK, error code on) is set, the balance always responds to reception of all commands sent from a PC or a PLC. Communication reliability is improved by checking the responding code.

When the function *ErEd I* (AK, error code on) is set, the balance responds with the following.

- When sending a command requesting various data to the balance, if the balance cannot transmit the requested data, it sends an error code (EC, Exx). If the balance can output the requested data, the requested data will be sent.
- When sending a controlling command to the balance, if the balance cannot execute the command, it sends an error code (EC, Exx). If the balance can execute the command, it sends the <AK> code.
<AK> code is the ASCII 06h code.
- The commands below are processed by the balance, so it will send the <AK> command not only when a command is received, but also at the end of processing. If the process does not end normally, the balance sends an error code (EC, Exx), in which case the error is canceled with the CAL command.

ON command	Display on
P command	Display on / off (However, only when already on)
Z, ZR commands	ZERO key
T, TR commands	Tare the balance
R, RZ commands	RE-ZERO (Semi-automatic zero-point setting) *1
CAL command	Sensitivity adjustment with the internal weight (GX-L series) Sensitivity adjustment with an external weight (GX-L series)
EXC command	Sensitivity adjustment with an external weight (GX-L series)

*1 If it is within the zero range, the zero point is updated. If it is beyond the zero range, tare subtraction is performed.

21-7-3. Command usage examples

In this example, the function *Er[d] 1* (AK, error code on) is set in order to output the <AK> code. <AK> code is the ASCII 06h code.

Example of the ON command (Display on)

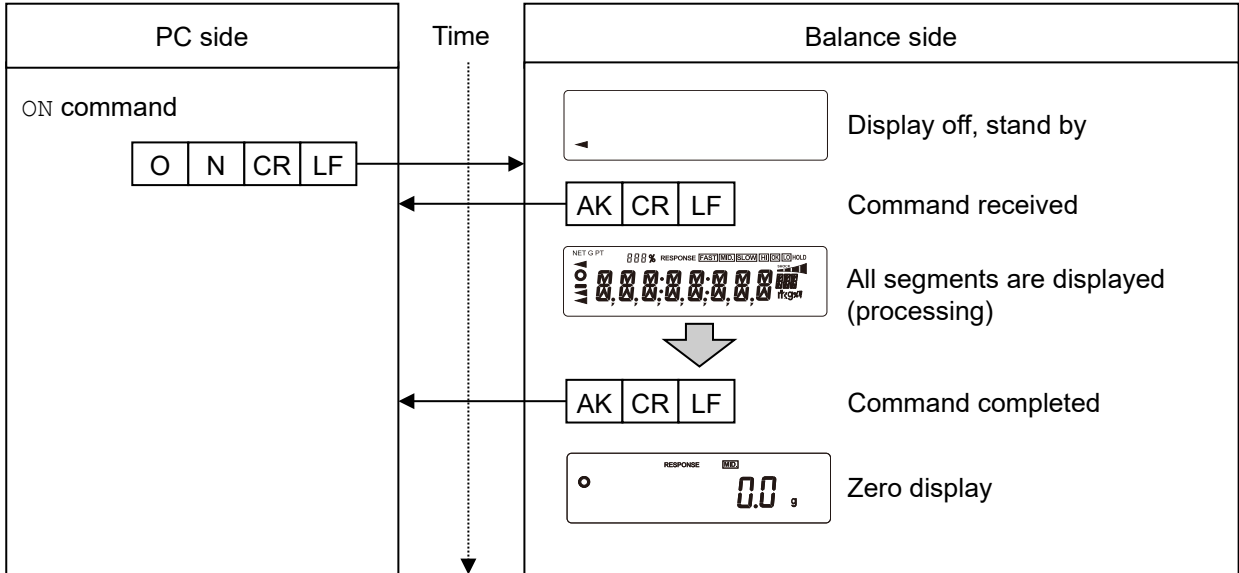

Example of the R command (Re-zero)

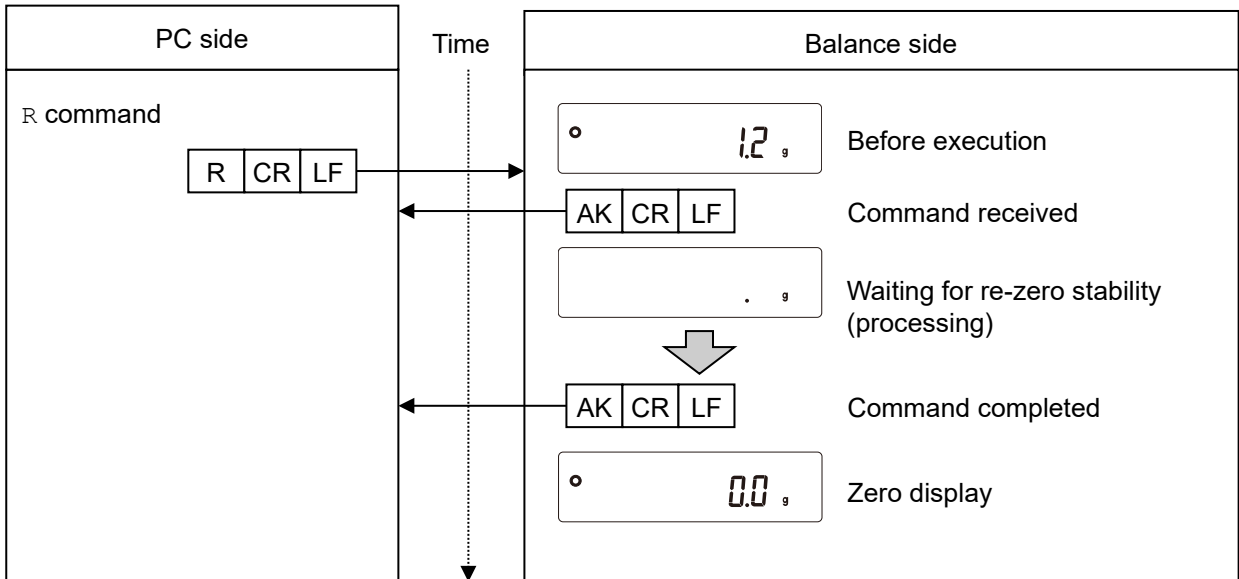

Example of the CAL command (GX-L Series: sensitivity adjustment with the internal weight)

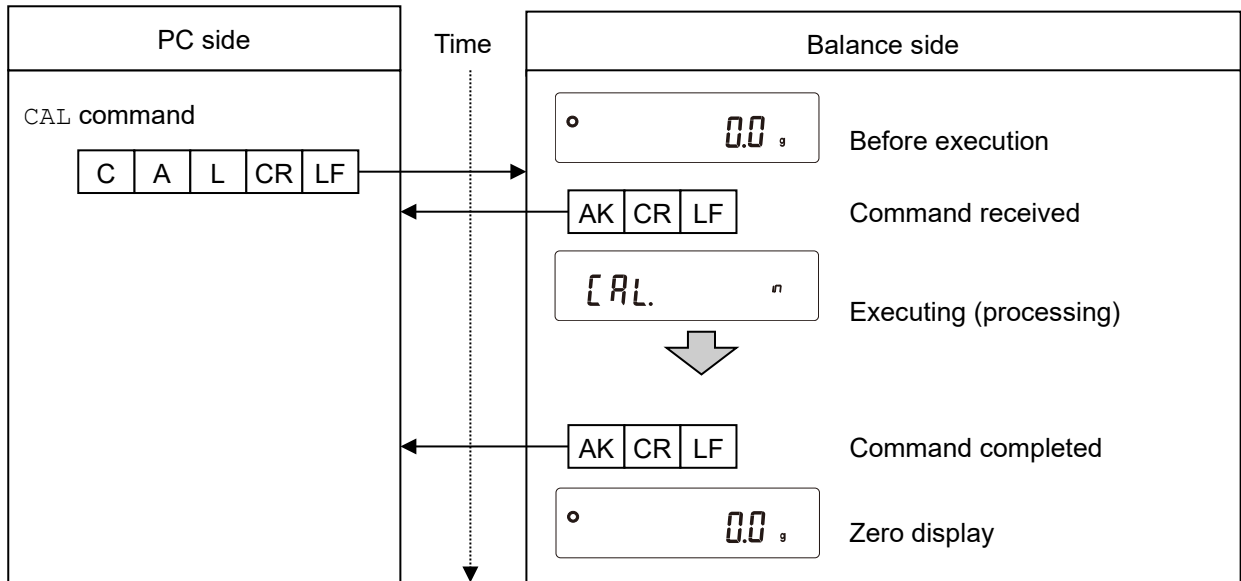

□ For an example of the CAL command of the GF-L series, refer to the EXC command example.

Example of error code output of the R command (Re-zero)

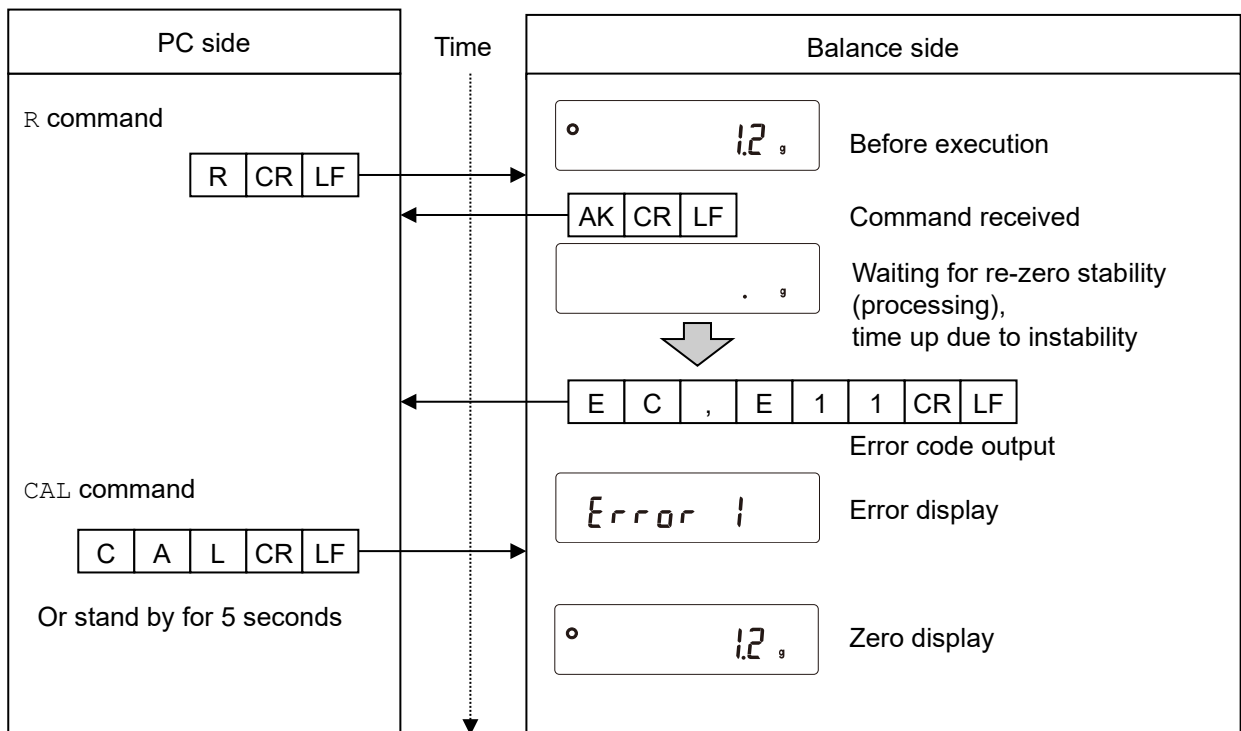

Example of the EXC command (Sensitivity adjustment with an external weight)

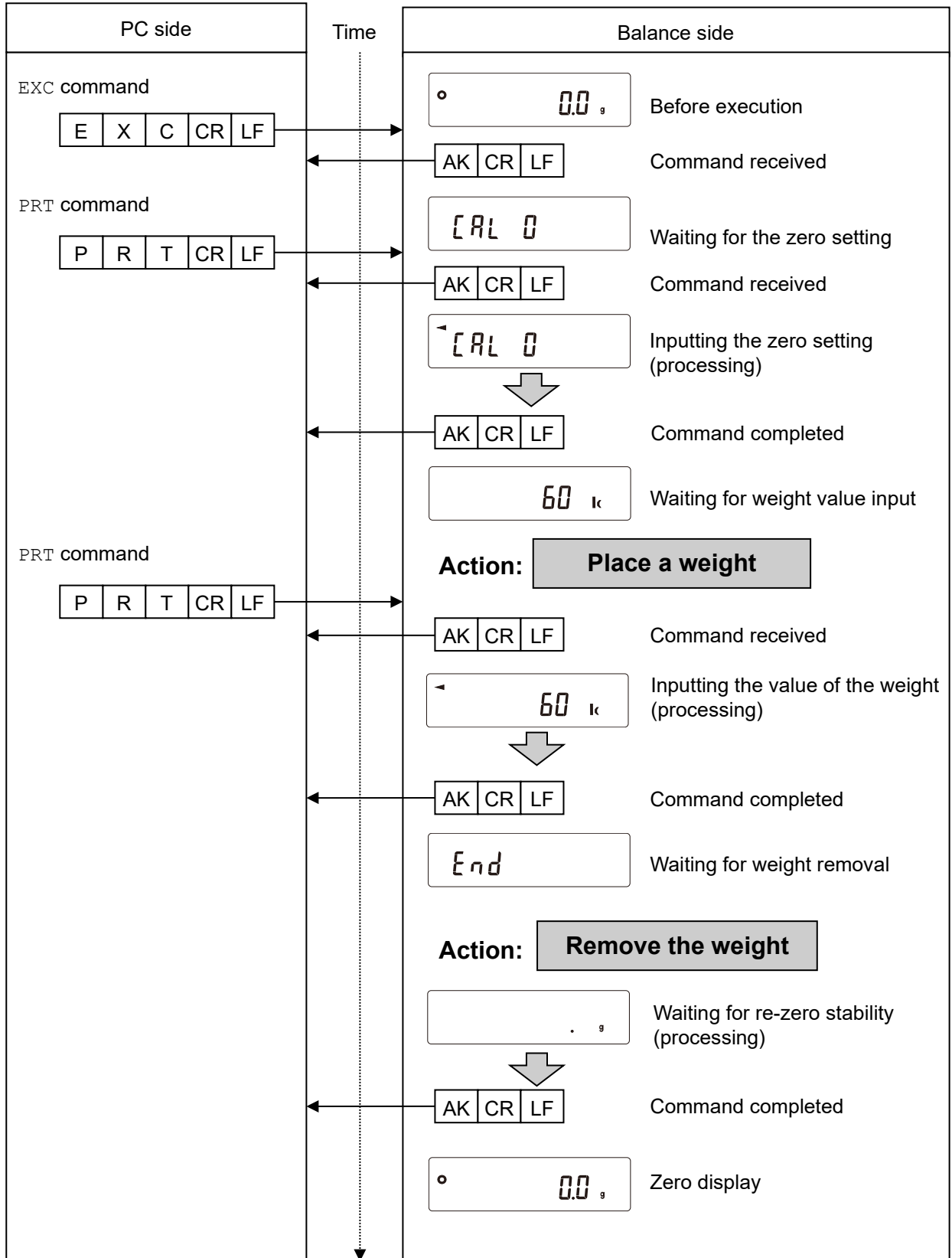

Example of weighing with a container

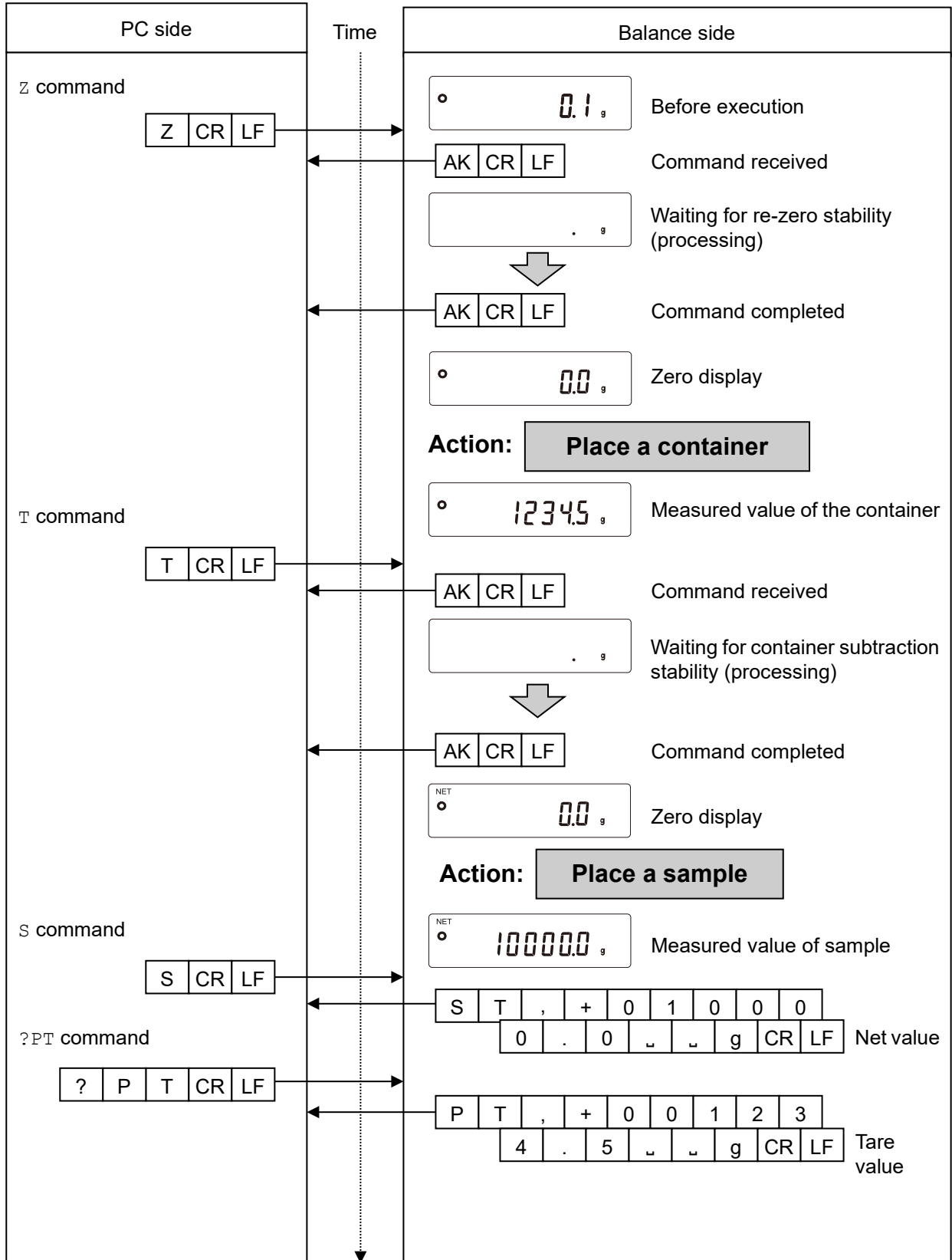

Example of setting a negative target value and filling with a sample until the display becomes zero

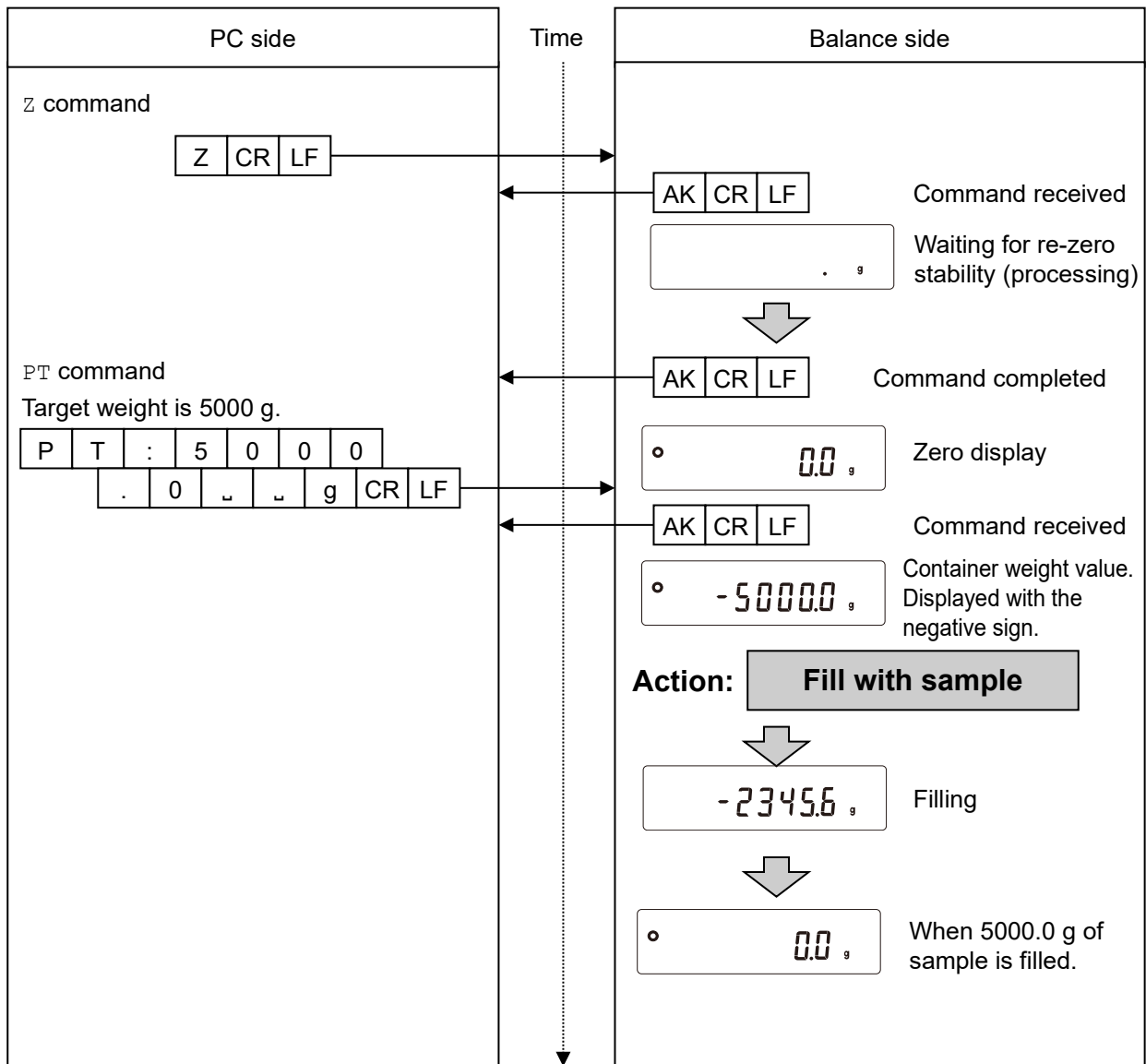

21-8. The UFC function

By using the Universal Flex Coms (UFC) function, it is possible to arbitrarily output contents of your choice when outputting the weighing data. You can also output a character string when printing a barcode with a label printer or the like.

In order to use the UFC function, it must be set to function *UFC 1* (UFC function on).

21-8-1. UFC program commands

To select the output format to use, send the program command from the PC and store it in the balance. The stored output format is saved even when the balance is turned off.

How to create program commands

- The maximum number of characters for a program command is 512.
- First, add the *PF* command.
- Program commands are combined in comma-delimited or space-separated form, but they can be omitted to reduce the number of characters. However, the comma after the *PF* command cannot be omitted.
- The maximum output characters per line by UFC is 416 characters.

List of program commands

In the output examples, " " indicates a space.

Command	Content	Output example
<i>PF</i> ,	UFC command header It is appended to the beginning of the program command.	
<i>\$MN</i>	Manufacturer name	_ _ _ _ _ A _ & _ D
<i>\$TY</i>	Model name	_ _ _ G X - 6 2 0 0 1 L
<i>\$SN</i>	Serial number	_ _ _ _ T 1 2 3 4 5 6 7
<i>\$ID</i>	ID number	S A M P L E - 1 2 3 4 - 5
<i>\$DT</i>	Date	2 0 2 3 / 0 4 / 2 3
<i>\$TM</i>	Time of Day	1 2 : 3 4 : 5 6
<i>\$WT</i>	Weight data	_ _ _ _ + 1 2 3 4 . 5 _ _ g
<i>\$GR</i>	Gross data (total amount)	_ _ _ _ + 1 2 3 4 . 5 _ _ g
<i>\$NT</i>	Net data (net)	_ _ _ _ _ + 2 3 4 . 5 _ _ g
<i>\$TR</i>	Tare data (tare)	_ _ _ _ + 1 0 0 0 . 0 _ _ g
<i>\$PC</i>	Number data	_ _ _ _ _ + 1 2 3 4 _ P C
<i>\$UW</i>	Single data	_ _ _ _ _ + 0 . 1 _ _ g
<i>\$CP</i>	Comparator result	H I
<i>\$CM</i>	Comma	,
<i>\$SP</i>	Space	_
<i>\$CR</i>	<CR>	
<i>\$LF</i>	<LF>	

- Enclose any ASCII code string in single quotation marks. The character strings that can be output are alphanumeric characters and symbols.

The single quotation mark itself is represented by two single quotation marks.

E.g. To output the character string: "A'BC'D": 'A"BC"D'

- To output the ASCII control code, enter "# + 2 hexadecimal characters".

E.g. To output <EOT> (04h): #04

- Spaces (\$SP), <CR > (\$CR), and <LF> (\$LF) can be repeated with numbers by adding " * + numbers (up to 2 characters)" after the command.

E.g. To output 12 spaces: \$SP*12

To output 9 <CR>'s: \$CR*9

- When sending a program command of two or more lines, adding "& " at the end of one line the balance will judge the next line as the continuation of the program command. (Only RS-232C)

- The balance sends an error code if there is a problem after receiving a program command and sends an <AK> code if there is no problem. <AK> code is ASCII 06h code.

- The UFC setting tool WinCT-UFC is available for inputting program commands. WinCT-UFC can be downloaded from A&D website (<https://www.aandd.jp>).

21-8-2. Examples of creating UFC program commands

Output example 1

```
NET
      +2000.0 g
TARE
      +345.6 g
GROSS
      +2345.6 g
```

Content

- PF, command, character string "NET", line break
- Space × 5, net data, line break
- Character string "TARE", line break
- Space × 6, tare data, line break
- Character string "GROSS", line break
- Space × 5, gross data

Example of program command

```
PF, 'NET', $CR, $LF, &
$SP*5, $NT, $CR, $LF, &
'TARE', $CR, $LF, &
$SP*6, $TR, $CR, $LF, &
'GROSS', $CR, $LF, &
$SP*5, $GR, $CR, $LF
└──────────┘
Terminator
```

Output example 2

```
2023/04/23 12:34:56
SAMPLE      ABC-123
WEIGHT     +3456.7 g
```

Content

- PF, command, date, time, line break
- Character string "SAMPLE ABC-123", line break
- Character string "WEIGHT ", weight data

Example of program command

```
PF, $DT, $TM, $CR, $LF, &
'SAMPLE      ABC-123', $CR, $LF, &
'WEIGHT     ', $WT, $CR, $LF
└──────────┘
Terminator
```

Caution

- The terminator transmission in UFC format is not sent automatically. Add a terminator code at the end of the character data as necessary.

21-9. Key lock function

Key switches of the balance can be locked by sending a specified command to the balance. This is effective for controlling the balance only from an external device such as a PC.

- ❑ Even if key switches are locked, operations related to key control commands are available. (For key control commands, refer to section "21-7. Commands".)
- ❑ Key lock status can be checked by sending a command for confirmation to the balance.
- ❑ Key lock is maintained until either the balance receives key unlock command or the power is turned off by unplugging the AC adapter.

21-9-1. Locking all key switches

All the key switches can be disabled by sending the `KL` command to the balance as follows.

Command string	Function
?KL	Requests all key lock statuses. KL,000 All key switches unlocked. KL,001 All key switches locked.
KL:***	KL:000 Unlock all key switches. KL:001 Lock all key switches. 000 or 001 should be input for ***.

21-9-2. Locking specified key switches

By assigning a numerical value for ***** of a LK command, specific key switches can be disabled. The numerical value for ***** is the total of the decimal numbers converted from the bit value assigned for each key switch as shown below.

bit	Decimal number	Key switch
0	1	ON:OFF
1	2	CAL
2	4	MODE
3	8	SAMPLE
4	16	PRINT
5	32	ZERO
6	64	TARE

Example 1: When locking all the switches except for PRINT.

1. Add all the decimal numbers corresponding to keys to lock.
 $1 (\text{ON:OFF}) + 2 (\text{CAL}) + 4 (\text{MODE}) + 8 (\text{SAMPLE}) + 32 (\text{ZERO}) + 64 (\text{TARE}) = 111$
2. Send the numeral value sum with a LK command to the balance. LK:00111

Example 2: Unlock all key switches.

1. Since there is no key switch to lock, 0 is sent to the balance with LK:. LK:00000

Command string	Function
?LK	Requests status for a specified key lock. Example 1) When all the key switches except for PRINT are locked. LK:00111 Example 2) When none of the switches are locked. LK:00000
LK:*****	Numerical value from 00000 to 00127 should be in *****. Example) When locking all the key switches except for PRINT. LK:00111

22. Checking the software version of the balance

Specifications of the balance may differ depending on the software version that you use.

To confirm the software version, follow the steps shown below.

1. Unplug the AC adapter of the balance and then plug it in again.

2. P- *.*.* is displayed.

In place of *.*.* , the software version is displayed.

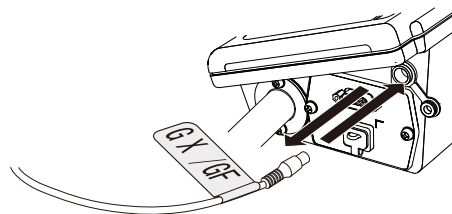

P-1000

23. Specifications

23-1. Common specifications

Internal weight		Installed in GX-L series models
Clock function		Available
Operating temperature and humidity range		5°C to 40°C, 85%RH or lower (no condensation)
Display refresh rate		5 times/second, 10 times/second, or 20 times/second
Units of measure		g (gram), kg (kilogram), pcs (counting mode), % (percent mode), oz (ounce), lb (pound), lb oz (pound/ounce), ozt (troy ounce), ct (metric carat), mom (momme), dwt (pennyweight), tl (tael), tol (tola), mes (messghal), DS (density mode), and user-programmable unit
Counting mode	Number of samples	5, 10, 25, 50, or 100 pieces
Percent mode	Readability	0.01%, 0.1%, 1% (Automatically changed by 100% mass)
Communication interface		USB and RS-232C
Power (AC adapter)		AC adapter Confirm that the adapter type is correct for the local voltage and power receptacle type. Power consumption: Approx. 30 VA (supplied to the AC adapter)
Dustproof and drip-proof rating		IP65

23-2. Individual specifications

GX-L Series

(Internal adjustment type)	GX-12001L	GX-22001L	GX-32001L GX-32001LS	GX-32001LD GX-32001LDS	GX-42001L
Weighing capacity	12 kg	22 kg	32 kg	32 kg	42 kg
Maximum display	12.0084 kg	22.0084 kg	32.0084 kg	32.008 kg / 6.2009 kg *3	42.0080 kg
Readability	0.1 g			1 g / 0.1 g	0.5 g
Repeatability (Standard deviation)	0.1 g			0.5 g / 0.1 g	0.5 g
Linearity	±0.2 g			±1 g / ±0.2 g	±1 g
Stabilization time (when set to FAST under a good environment)	Approx. 1.5 seconds				
Sensitivity drift (when automatic sensitivity adjustment is not used, at 10°C to 30°C)	±3 ppm/°C			±5 ppm/°C	±5 ppm/°C
Accuracy right after sensitivity adjustment using the internal weight. *1	±1.0 g		±1.5 g		
Counting mode	Minimum unit mass	0.1 g		1 g	0.5 g
Percent mode	Minimum 100% mass	10 g		100 g	50 g
External sensitivity adjustment weights	5 kg, 10 kg	5 kg, 10 kg, 20 kg	5 kg, 10 kg, 20kg, 30kg		10 kg, 20 kg, 30 kg, 40 kg
Weighing pan	384 × 344 mm				
External dimensions	372(W) × 615(D) × 130(H) mm (GX-LS (base unit): 344(W) × 442(D) × 130(H) mm *2)				
Net weight	Approx. 17 kg				

*1 Accuracy right after sensitivity adjustment using the internal weight in good ambient conditions (within the temperature range of 10°C to 30°C with no abrupt changes in temperature or humidity, no vibration, no drafts, no effect by magnetic fields or static electricity).

The internal weight may change in mass due to the operating environment, aging, and other factors. It is advisable to perform regular maintenance and sensitivity adjustment using an external weight.

*2 The dimensions of the display unit for separate type models (GX-32001LS / 32001LDS / 62001LS / 62000LS / 102000LS) are 260(W) × 164(D) × 202(H) mm.

The length of the cable for separate type models (GX-32001LS / 32001LDS / 62001LS / 62000LS / 102000LS) is 3 m.

*3 Weighing with precision range is possible even with a heavy tare placed on the pan. (Smart range function)

GX-L Series

(Internal adjustment type)		GX-62001L GX-62001LS	GX-62000L GX-62000LS	GX-102000L GX-102000LS
Weighing capacity		62 kg		102 kg
Maximum display		62.0084 kg	62.084 kg	102.084 kg
Readability		0.1 g	1 g	
Repeatability (Standard deviation)		0.2 g	0.7 g	1 g
Linearity		±0.5 g	±1 g	±2 g
Stabilization time (when set to FAST under a good environment)		Approx. 1.5 seconds		
Sensitivity drift (when automatic sensitivity adjustment is not used, at 10°C to 30°C)		±6 ppm/°C		
Accuracy right after sensitivity adjustment using the internal weight. *1		±3 g	±5 g	±10 g
Counting mode	Minimum unit mass	0.1 g	1 g	
Percent mode	Minimum 100% mass	10 g	100 g	
External sensitivity adjustment weights		10 kg, 20 kg, 30 kg, 40 kg, 50 kg, 60 kg	10 kg, 20 kg, 30 kg, 40 kg, 50 kg, 60 kg	10 kg, 20 kg, 40 kg, 50 kg, 60 kg, 80 kg, 100 kg
Weighing pan		384 × 344 mm		386 × 346 mm
External dimensions		372(W) × 615(D) × 130(H) mm (GX-LS (base unit): 344(W) × 442(D) × 130(H) mm *2)		373(W) × 615(D) × 130(H) mm (GX-LS (base unit): 346(W) × 443(D) × 130(H) mm*2)
Net weight		Approx. 17 kg		Approx. 18 kg

*1 Accuracy right after sensitivity adjustment using the internal weight in good ambient conditions (within the temperature range of 10°C to 30°C with no abrupt changes in temperature or humidity, no vibration, no drafts, no effect by magnetic fields or static electricity).

The internal weight may change in mass due to the operating environment, aging, and other factors. It is advisable to perform regular maintenance and sensitivity adjustment using an external weight.

*2 The dimensions of the display unit for separate type models (GX-32001LS / 32001LDS / 62001LS / 62000LS / 102000LS) are 260(W) x 164(D) x 202(H) mm.

The length of the cable for separate type models (GX-32001LS / 32001LDS / 62001LS / 62000LS / 102000LS) is 3 m.

GF-L Series

(External adjustment type)	GF-12001L	GF-22001L	GF-32001L	GF-62000L
Weighing capacity	12 kg	22 kg	32 kg	62 kg
Maximum display	12.0084 kg	22.0084 kg	32.0084 kg	62.084 kg
Readability	0.1 g			1 g
Repeatability (Standard deviation)	0.1 g			0.7 g
Linearity	±0.2 g			±1 g
Stabilization time (when set to FAST under a good environment)	Approx. 1.5 seconds			
Sensitivity drift (when automatic sensitivity adjustment is not used, at 10°C to 30°C)	±3 ppm/°C			±6 ppm/°C
Counting mode	Minimum unit mass	0.1 g		1 g
Percent mode	Minimum 100% mass	10 g		100 g
External sensitivity adjustment weights	5kg, 10kg	5 kg, 10 kg, 20 kg	5 kg, 10 kg, 20kg, 30kg	10 kg, 20 kg, 30 kg, 40 kg, 50 kg, 60 kg
Weighing pan	384 X 344 mm			
External dimensions	372(W) x 615(D) x 130(H) mm			
Net weight	Approx. 15 kg			

24. External Dimensions

(1) Swing-arm type

GX-12001L / 22001L / 32001L / 32001LD / 42001L / 62001L / 62000L / 102000L

GF-12001L / 22001L / 32001L / 62000L

※() for GX-102000L

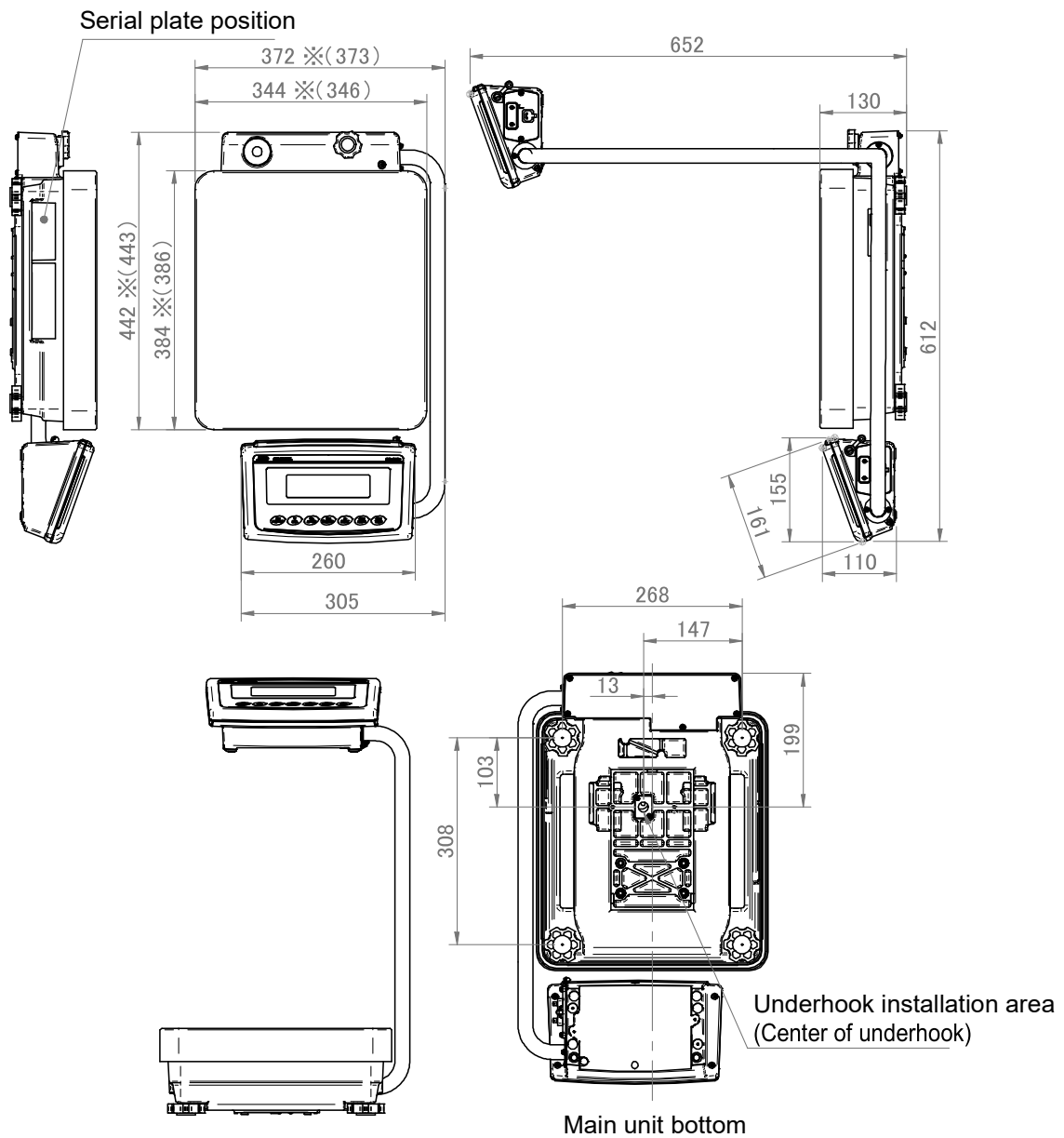

Unit: mm

(2) Separate type

GX-32001LS / 32001LDS / 62001LS / 62000LS / 102000LS

※() for GX-102000LS

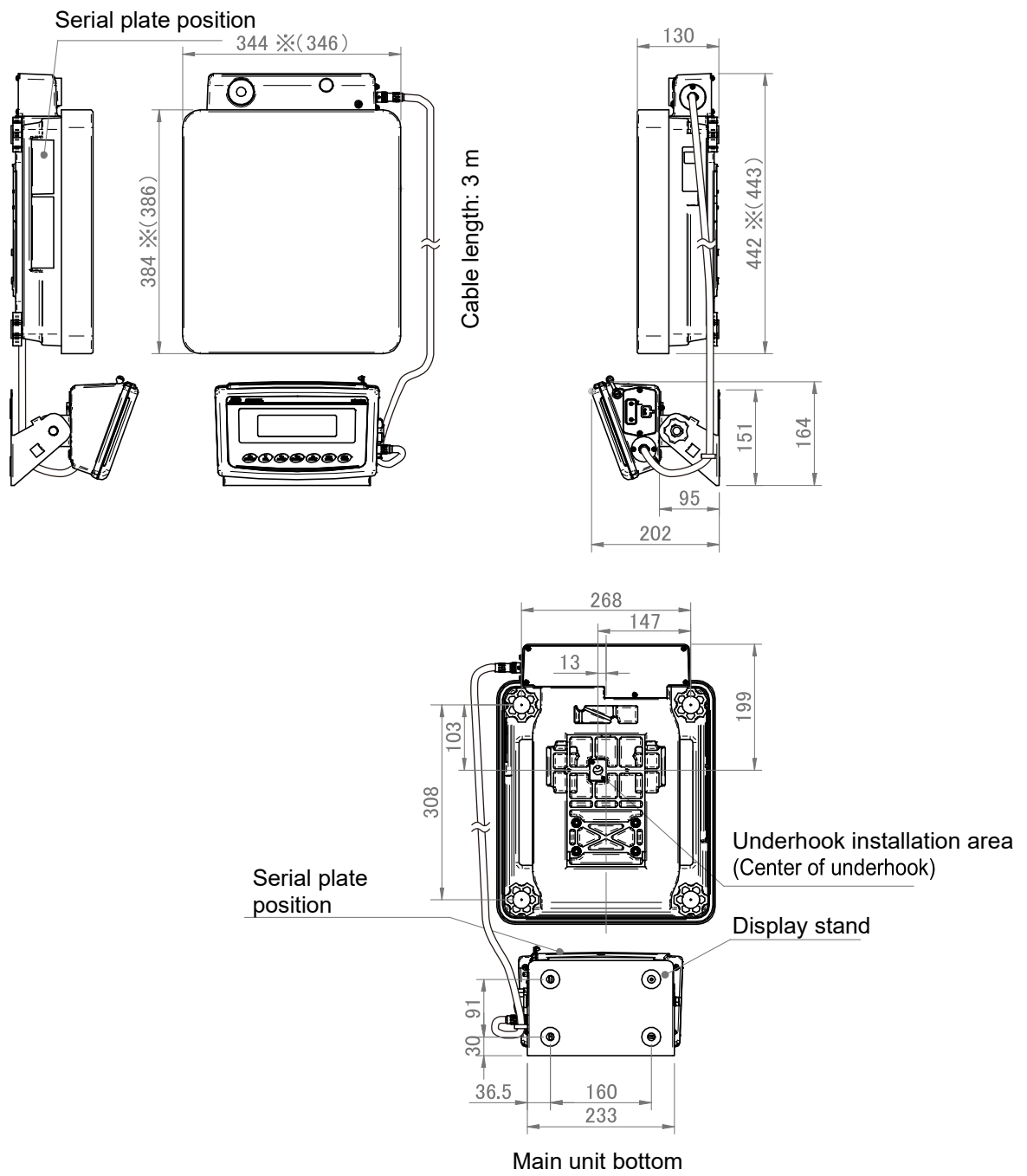

Unit: mm

25. Options and Accessories

25-1. Options

Caution

Only one of GXL-04, GXL-06, GXL-08, GXL-27, or the standard (RS-232C and USB) interfaces can be used. The GX-L/GF-L series are not IP65 with GXL-04, GXL-06 or GXL-08.

Name		Description
GXL-04	Comparator output	<ul style="list-style-type: none"> <input type="checkbox"/> Equipped with comparator relay output and buzzer (miniDIN 8pin), "RS-232C interface", and external control input terminals that can perform the "RE-ZERO" and "PRINT" operations. <input type="checkbox"/> Can compare the weighing value and preset threshold values and output the result to the contact output. <input type="checkbox"/> Equipped with six contact outputs: "HH", "HI", "OK", "LO", "LL" of the comparison output and "READY" output to indicate the status of the balance. <input type="checkbox"/> Can sound a buzzer according to the comparison result. <input type="checkbox"/> The optional footswitches (AX-SW137-PRINT and AXSW137-REZERO) can be used for the external contact input terminals that can operate the "RE-ZERO" and "PRINT".
GXL-06	Analog voltage output	<ul style="list-style-type: none"> <input type="checkbox"/> Can output analog voltage in the following modes: "mode where the specified digits of the weighing value are converted to voltage" and "mode where weighing value is converted to voltage in range between gross zero or net zero and full scale". <input type="checkbox"/> The voltage output range can be selected using the "0V /0.2V " switch on the panel. It can be selected "0 to 1V" range and "0.2V to 1V" range. The factory setting is "0 to 1V" range.
GXL-07	Extension cable for separate type models, 5 m	<ul style="list-style-type: none"> <input type="checkbox"/> Used to replace the standard 3 m cable.

Name		Description
GXL-08	Ethernet (TCP/IP) interface	<ul style="list-style-type: none"> ❑ Can connect the balance to a LAN (Ethernet) and perform bi-directional communication with a PC on the LAN. ❑ Windows Data Communication Software for LAN Connection "WinCT-Plus" can be downloaded from A&D website. <ul style="list-style-type: none"> ➤ Enables data acquisition from multiple weighing instruments with a single PC via LAN connection. ➤ Weighing instruments can be controlled by sending commands from the PC. ➤ Data acquisition (e.g.) Data is transmitted to the PC by pressing the PRINT key on the balance. ➤ Recorded data can be formatted in Microsoft Excel. (Microsoft Excel must be pre-installed.)
GXL-27	Bluetooth® interface	<ul style="list-style-type: none"> ❑ Weighing values can be input to a PC, tablet, or smartphone equipped with Bluetooth®. (HID function) ❑ The AD8541-PC dongle for PC connection enables wireless command communication with a PC.
GP-12	Animal weighing bowl	<ul style="list-style-type: none"> ❑ Used for weighing small animals. ❑ Placing the animal weighing bowl reduces the weighing capacity by about 4 kg.
GP-16	AD-8127 printer support	<ul style="list-style-type: none"> ❑ The printer support used to install the AD-8127 to the balance.
GP-20 / 21	Underhook	<ul style="list-style-type: none"> ❑ For underhook weighing. ❑ For measuring density and weighing magnetic materials.
AX-GXL-31	Display clear cover, 5 pieces	<ul style="list-style-type: none"> ❑ Standard accessory display clear cover.

25-2. Accessories (sold separately)

Name		Description
AD-8127	Multi-functional compact printer	<ul style="list-style-type: none"> <input type="checkbox"/> Small dot impact printer that connects with the balance via the RS-232C interface. <input type="checkbox"/> Various functions such as clock and calendar function, statistical function, interval print function, graphic print function, etc. are provided.
AD-8920A	Remote display	<ul style="list-style-type: none"> <input type="checkbox"/> Weighing values can be read remotely from the balance by connecting via the RS-232C interface.
AD-8922A	Remote controller	<ul style="list-style-type: none"> <input type="checkbox"/> The balance can be remotely operated by connecting via the RS-232C interface. <input type="checkbox"/> Optional analog and comparator outputs can be installed.
AD-1683A	Static eliminator (Ionizer)	<ul style="list-style-type: none"> <input type="checkbox"/> Static eliminator that prevents error which can be caused when weighing samples are electrically charged. <input type="checkbox"/> Its direct-current system and plentiful ion content enable weighing without breeze, which is ideally suited for precisely measuring powder and such. <input type="checkbox"/> Equipped with a non-contact switch, it operates only when static elimination is required.
AD-1684A	Electrostatic field meter	<ul style="list-style-type: none"> <input type="checkbox"/> An indicator that measures how much the weighing sample and tare, or the balance's peripheral devices such as breeze break (e.g. automatic weighing line) are electrically charged and shows the result. When electric charge is observed, it can be eliminated with AD-1683 (Ionizer).
AX-KO2737-500	Waterproof RS-232C cable (5 m D-Sub 9-pin female - female)	<ul style="list-style-type: none"> <input type="checkbox"/> Length: 5 m. D-Sub 9-pin to 9-pin <input type="checkbox"/> Only the 9-pin on the balance side is a waterproof type.
AX-KO7695-500	Waterproof RS-232C cable (5 m D-Sub 9-pin female - male)	<ul style="list-style-type: none"> <input type="checkbox"/> Length: 5 m. D-Sub 9-pin to 9-pin <input type="checkbox"/> Only the 9-pin on the balance side is a waterproof type.
AX-KO5465-180	USB cable (A - mini B type. 1.8 m)	<ul style="list-style-type: none"> <input type="checkbox"/> Length: 1.8 m. A - mini B type <input type="checkbox"/> Standard accessory
AX-USB-9P	Serial/USB converter with cable (Cable length: approx. 80 cm) External type	<ul style="list-style-type: none"> <input type="checkbox"/> Adds a COM port to a PC. <input type="checkbox"/> Enables bi-directional communication between the PC and the balance when a USB driver is installed. <input type="checkbox"/> Serial communication software such as "WinCT" can be used via USB connection on a PC without COM ports.

Name		Description
AD-1687	Weighing environment logger	<ul style="list-style-type: none"> ❑ A data logger equipped with 4 sensors for temperature, humidity, barometric pressure and vibration that can measure and store environmental data. When connected to the RS-232C interface of a balance, the AD-1687 can store environmental data along with weighing data. Data can be saved even in environments where a PC cannot be brought in. ❑ The stored data can be read via a PC's USB port. As the AD-1687 is recognized as a USB flash drive, special software is not required to read the data.
AD-1688	Weighing data logger	<ul style="list-style-type: none"> ❑ AD-1688 connected to the RS-232C interface of a balance can store the data that the balance outputs. Weighing data can be saved even in environments where a PC cannot be brought in. ❑ The stored data can be read via a PC's USB port. As the AD-1688 is recognized as a USB flash drive, special software is not required to read the data.
AD-8526	Serial/Ethernet (TCP/IP) converter	<ul style="list-style-type: none"> ❑ This converter can be used to connect the RS-232C interface of the balance to the Ethernet (LAN) port of a computer. This allows management of the balance weighing data with a computer connected to a network. Data communication software "WinCT-Plus" is included.
AD-8527	Quick USB adapter	<ul style="list-style-type: none"> ❑ No battery or driver software required. Weighing data transmission to a PC is done in real time. Data can be transmitted directly to an application such as Excel and Word. Compliant with IP65.
AD-1682	Rechargeable battery unit	<ul style="list-style-type: none"> ❑ Allows use of the balance in a place where AC power source is not available. This unit can be recharged and used repeatedly.

THIS PAGE INTENTIONALLY LEFT BLANK.



A&D Company, Limited

3-23-14 Higashi-Ikebukuro, Toshima-ku, Tokyo 170-0013, JAPAN
Telephone: [81] (3) 5391-6132 Fax: [81] (3) 5391-1566

A&D ENGINEERING, INC.

47747 Warm Springs Blvd, Fremont, California 94539, U.S.A.
Tel: [1] (800) 726-3364 Weighing Support:[1] (888) 726-5931 Inspection Support:[1] (855) 332-8815

A&D INSTRUMENTS LIMITED

Unit 24/26 Blacklands Way, Abingdon Business Park, Abingdon, Oxfordshire OX14 1DY United Kingdom
Telephone: [44] (1235) 550420 Fax: [44] (1235) 550485

A&D AUSTRALASIA PTY LTD

32 Dew Street, Thebarton, South Australia 5031, AUSTRALIA
Telephone: [61] (8) 8301-8100 Fax: [61] (8) 8352-7409

A&D KOREA Limited

한국에이.엔.디(주)
서울특별시 영등포구 국제금융로6길33(여의도동) 맨하탄빌딩 817 우편 번호 07331
(817, Manhattan Bldg., 33. Gukjegeumyung-ro 6-gil, Yeongdeungpo-gu, Seoul, 07331 Korea)
전화: [82] (2) 780-4101 팩스: [82] (2) 782-4264

OOO A&D RUS

ООО "ЭЙ энд ДИ РУС"

Почтовый адрес:121357, Российская Федерация, г.Москва, ул. Верейская, дом 17
Юридический адрес: 117545, Российская Федерация, г. Москва, ул. Дорожная, д.3, корп.6, комн. 86
(121357, Russian Federation, Moscow, Vereyskaya Street 17)
тел.: [7] (495) 937-33-44 факс: [7] (495) 937-55-66

A&D Instruments India Private Limited

ऐ&डी इन्स्ट्र्यूमेन्ट्स इण्डिया प्रा० लिमिटेड

D-48, उद्योग विहार , फेस -5, गुडगांव - 122016, हरियाणा , भारत
(D-48, Udyog Vihar, Phase-V, Gurgaon - 122016, Haryana, India)
फोन : [91] (124) 4715555 फैक्स : [91] (124) 4715599

A&D SCIENTECH TAIWAN LIMITED.

A&D台灣分公司 艾安得股份有限公司

台湾台北市中正區青島東路5號4樓
(4F No.5 Ching Tao East Road, Taipei Taiwan R.O.C.)
Tel : [886](02) 2322-4722 Fax : [886](02) 2392-1794

A&D INSTRUMENTS (THAILAND) LIMITED

บริษัท เอ แอนด์ ดี อินสตรูमेंท์ (ไทยแลนด์) จำกัด

168/16 หมู่ที่ 1 ตำบลรังสิต อำเภอธัญบุรี จังหวัดปทุมธานี 12110 ประเทศไทย
(168/16 Moo 1, Rangsit, Thanyaburi, Pathumthani 12110 Thailand)
Tel : [66] 20038911