

EJ Series

Compact Balance

型番EJ20 / 型番EJ200 / 型番EJ300 / 型番EJ400 / 型番EJ600
型番EJ500 / 型番EJ2000 / 型番EJ3000 / 型番EJ4000 / 型番EJ6000



INSTRUCTION MANUAL

AND

A&D Company, Limited

This manual and Marks

All safety messages are identified by the following, "WARNING" or "CAUTION", of ANSI Z535.4 (American National Standard Institute: Product Safety Signs and Labels). The meanings are as follows:

 WARNING	A potentially hazardous situation which, if not avoided, could result in death or serious injury.
 CAUTION	A potentially hazardous situation which, if not avoided, may result in minor or moderate injury.



This is a hazard alert mark.

Note This manual is subject to change without notice at any time to improve the product. No part of this manual may be photocopied, reproduced, or translated into another language without the prior written consent of the A&D Company.

Product specifications are subject to change without any obligation on the part of the manufacture.

Compliance with FCC rules

Please note that this equipment generates, uses and can radiate radio frequency energy. This equipment has been tested and has been found to comply with the limits of a Class A computing device pursuant to Subpart J of Part 15 of FCC rules. These rules are designed to provide reasonable protection against interference when this equipment is operated in a commercial environment. If this unit is operated in a residential area it might cause some interference and under these circumstances the user would be required to take, at his own expense, whatever measures are necessary to eliminate the interference. (FCC = Federal Communications Commission in the U.S.A.)

Copyright©2009 A&D Company, Limited

CONTENTS

1. INTRODUCTION	3
2. UNPACKING	3
3. PART NAMES AND FUNCTIONS	4
4. SETTING UP	5
4-1. Setting up your balance	5
4-2. Power source	5
4-3. Breeze break	6
4-4. Storage	6
5. OPERATION	7
5-1. Turn the power ON and OFF	7
5-2. LCD backlight	7
5-3. Units	8
5-4. Selecting a weighing unit	9
5-5. Basic operation	9
5-6. Counting mode (pcs)	10
5-7. Percent mode (%)	11
6. COMPARATOR	12
6-1. Setting example	12
7. CALIBRATION	14
7-1. Calibration using a weight	14
7-2. Gravity acceleration correction	16
8. FUNCTIONS	17
8-1. Key operation	17
8-2. Entering the function setting mode	17
8-3. Setting example	18
8-4. Storing weighing units	19
8-5. Function list	20
9. OPTIONS	22
9-1. EJ-02 USB Interface	22
9-2. EJ-03 RS-232C serial interface	22
9-3. EJ-07 / EJ-08 Underhook	26
9-4. EJ-11 Breeze break	26
9-5. EJ-12 Carrying case	26
9-6. EJ-13 Density Determination Kit	27
10. ID NUMBER AND GLP	30
10-1. Setting the ID number	30
10-2. Output example	31
10-3. Calibration test using a weight	32

11. MAINTENANCE	34
11-1. Notes on maintenance	34
11-2. Error codes	34
12. SPECIFICATIONS	36
12-1. EJ series	36
12-2. Other weighing units	37
12-3. Options	38
12-4. Dimensions	38
GRAVITY ACCELERATION MAP	39

1. INTRODUCTION

This manual describes how this balance works and how to get the most out of it in terms of performance.

EJ series balances have the following features:

- ❑ The EJ series are high-resolution type electronic balances having a display resolution of 1/12,000 ~ 1/60,000.
- ❑ The balance has a counting function, % function and a comparator function.
- ❑ The backlight LCD will help with use in a dimly lighted place.
- ❑ The balance can be operated with an AC adapter, or 4 x “AA” size dry-cell batteries for cordless operation.
- ❑ The optional RS-232C serial interface can be connected with a printer or personal computer, and Good Laboratory Practice (GLP) data can be obtained.
- ❑ The optional USB interface is available to connect with a personal computer easily.

2. UNPACKING

When unpacking, check whether all of the following items are included:

Weighing pan

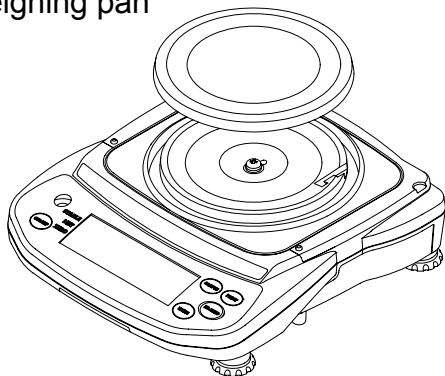

Main unit

EJ-120 / EJ-200 / EJ-300
EJ-410 / EJ-610

Weighing pan

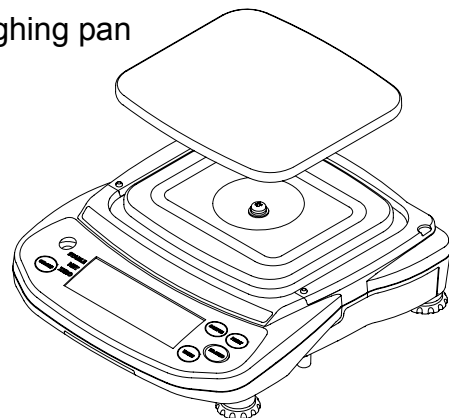

Main unit

EJ-1500 / EJ-2000 / EJ-3000
EJ-4100 / EJ-6100

AC adapter

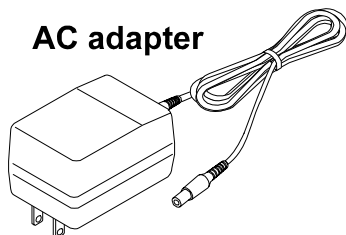





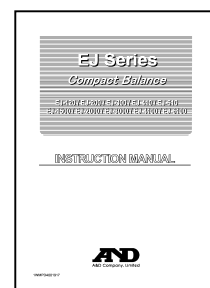

Please confirm that the AC adapter type is correct for your local voltage and receptacle type.

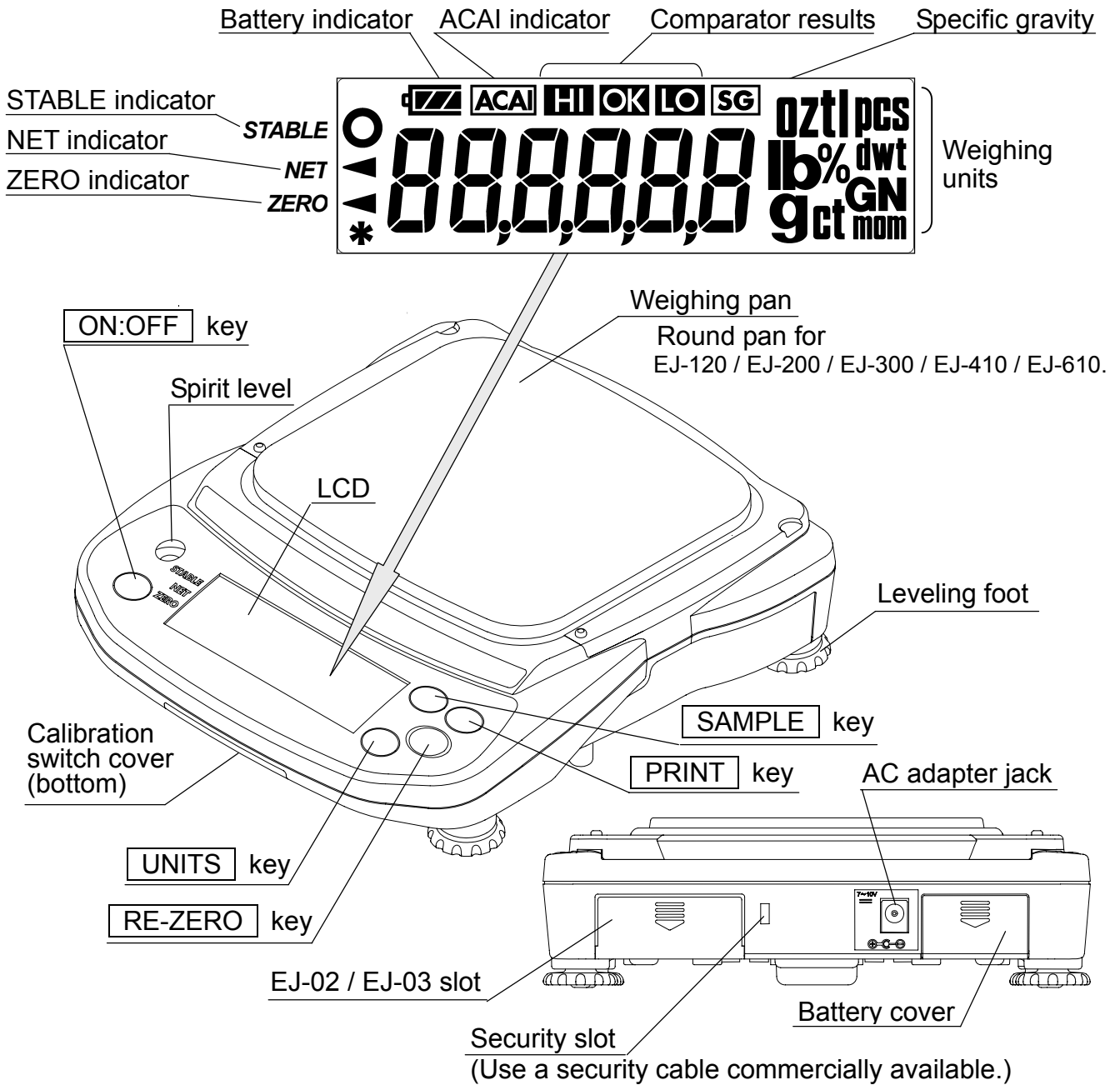
Instruction Manual



3. PART NAMES AND FUNCTIONS

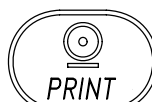

 <p>ON:OFF</p>	Turns the power on or off.	 <p>RE-ZERO</p>	Clears the display to zero (combined zero and tare).
 <p>SAMPLE</p>	<p>Held down to enter the function setting mode.</p> <p>pcs mode: Enters the sample unit weight storing mode.</p> <p>% mode: Enters the 100% weight storing mode.</p>	 <p>PRINT</p>	<p>Outputs the weight value to printer.</p> <p>Stores a unit weight, 100% weight or other setting values to the balance.</p>
		 <p>UNITS</p>	Switches the weighing units.

4. SETTING UP

4-1. Setting up your balance

1. Place the weighing pan on the main unit as shown in “2. UNPACKING”.
2. Adjust the level of the balance using the leveling feet. Use the spirit level to confirm. The bubble should be in the center of the circle.
3. Calibrate your balance before use. (See “7. CALIBRATION”)

Balance location

To measure correctly, to keep the balance in good condition, and to prevent hazards, observe the following:

- Do not install the balance in locations that are subject to excessive dust, breezes, vibration, large temperature fluctuations, condensation, or that may have magnetic fields.
- Do not install the balance on a surface that is soft or that may cause the balance level to shift.
- Do not install the balance in direct sunshine.
- Do not install the balance near heaters or air conditioners.
- Do not use an unstable AC power source.
- Do not install the balance in a place where combustible or corrosive gases may exist.
- Allow the balance to reach equilibrium with the ambient temperature before use.
- Switch the power ON at least half an hour before use so that the balance can warm up.
- When the balance is installed for the first time, or the balance has been moved, carry out calibration as described in “7. CALIBRATION”

4-2. Power source

For the power source, the AC adapter or 4 x “AA” size dry-cell batteries can be used.

When using the AC adapter

Use a stable power source. To use the AC adapter, insert the AC adapter plug into the AC adapter jack on the rear side of the EJ.

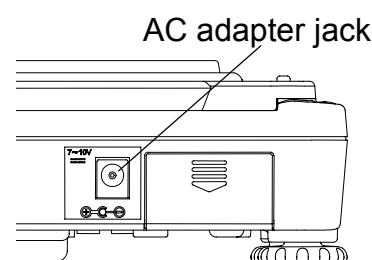

When using the dry-cell batteries

Prepare 4 x AA size (LR6 / R6P) dry cell batteries. The batteries are not included in the product,

CAUTION

- Take great care of the polarity of batteries. The polarity marks are shown in the battery box.
- Replace used batteries with four new ones when “Lb0” is displayed.
- Do not mix used and new batteries. Do not mix the battery type. It may cause damage to the batteries and the balance.
- The battery life depends on the ambient temperature, how to use and so on.

- Remove batteries when the balance is not to be used for a long time. They may leak and cause damage to the balance.
- Damage due to battery leakage is not covered by the warranty.

Installing batteries

1. Turn off the balance and disconnect the AC adapter if used.
2. Slide the battery cover off.
3. Push the battery box up to unhook and pull it out.
4. Insert new four batteries (LR6 / R6P / AA size) into the battery box, taking extreme care of the polarities.
5. Push the battery box into the balance as before.
6. Attach the battery cover.

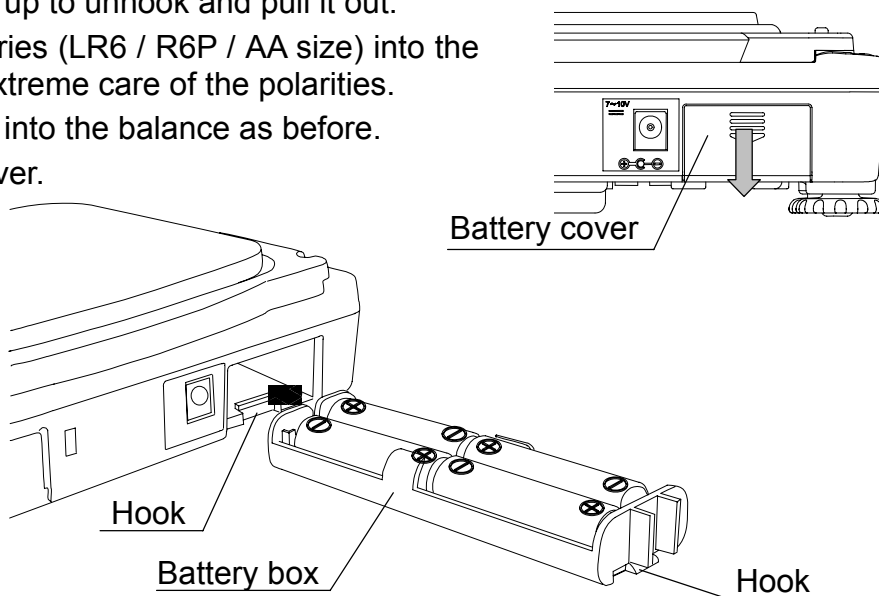

- Battery indicator turns on when the balance is operated by the batteries. It will change as the battery voltage decreases.



4-3. Breeze break

The optional breeze break is available. See "9-4. EJ-11 Breeze break".

4-4. Storage

The EJ series balance can stack on top of another when not in use.

- Do not stack more than 3 units.

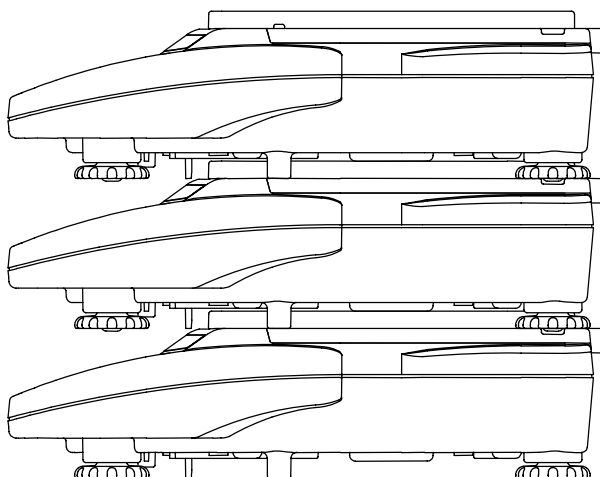

5. OPERATION

5-1. Turn the power ON and OFF

1. Press the ON:OFF key to turn the power ON.



All of the symbols are displayed as shown above.
(About units: Only the units available will be displayed.)

The display turns off except for a weighing unit and the decimal point.
The balance waits for the weighing data to become stable, and zero will be displayed with the ZERO indicator (power-on zero).

The range for power-on zero is within $\pm 10\%$ of the weighing capacity around the calibrated zero point.
If the power is switched ON while there is a load beyond this range, the balance will be tared to zero and the NET indicator and the ZERO indicator turn on.

2. Press the ON:OFF key again, and the power will be switched OFF.

Auto-power off function

It is possible to have the power automatically switched OFF, if zero is displayed for approximately 5 minutes. See "8-5. Function list" and set the function "POFF".

5-2. LCD backlight

The LCD backlight will turn on when the weight value changes more than 4d (4 x min. display division) or any key operation is done. When the weight data becomes and stays stable for some moment, the backlight will automatically turn off. There is also a setting that the backlight is always on or off. For details, see the function setting "LEUP" of "Function list".

5-3. Units

The most common unit of weight used around the world is the gram, but there is often a need to shift to alternative units specific to the country where the balance is used or to select modes such as counting or percent.

The units and the order they appear in the display are as follows:

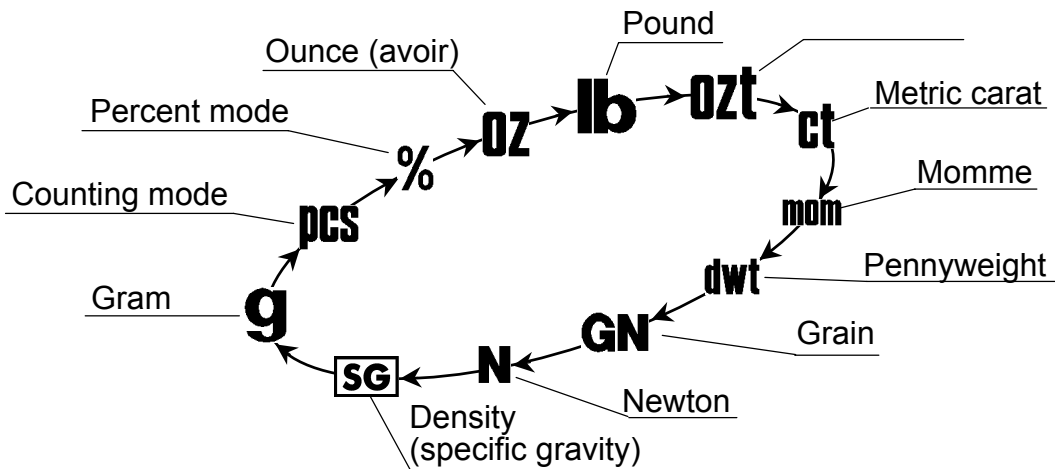

Among the units, those available for the user have been set at the factory before shipping.

The unit can be selected in the function setting mode. The order of the units available is the same as above.

□ Note

It is possible to store only the units that will be actually used from the units available. It is also possible to specify the display unit that will be shown first when the power is switched ON. For details, see “8-4. Storing weighing units”.

Conversion table

Units	Name	Conversion to gram
oz	Ounce (avoir)	28.349523125 g
lb	Pound (UK)	453.59237 g
ozt	Troy ounce	31.1034768 g
ct	Metric carat	0.2 g
mom	momme	3.75 g
dwt	Pennyweight	1.55517384 g
GN	Grain (UK)	0.06479891 g
t	tola	11.6638038 g
tl	tael (Hong Kong general, Singapore)	37.7994 g
tl	tael (Hong Kong jewelry)	37.4290 g
tl	tael (Taiwan)	37.5 g

- “Newton” is the value calculated by “(g value) x (9.80665 m/s²) / 1000”.
- The unit “t (tola)” and three kinds of “tl (tael)” are for special versions only. One of them can be selected and installed at the factory.

5-4. Selecting a weighing unit

Press the **UNITS** key to select a unit.

The following sections are a description of the three common units: g (gram mode), pcs (counting mode), and % (percent mode).



Each pressing switches the units available in the order described on the previous page.

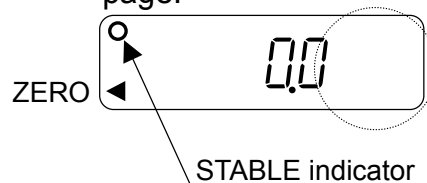

5-5. Basic operation

1. Select a weighing unit.
2. When the display does not show zero, press the **RE-ZERO** key to set the display to zero.
3. When using a tare (container), place the container on the weighing pan, and press the **RE-ZERO** key to subtract the tare weight.
4. Place the object to be weighed on the pan or in the container.
Wait for the STABLE indicator to be displayed and read the value.
5. Remove the object from the pan.

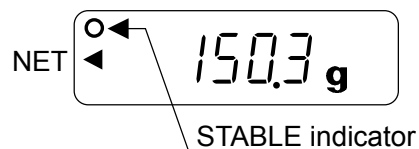
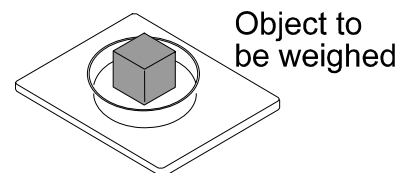
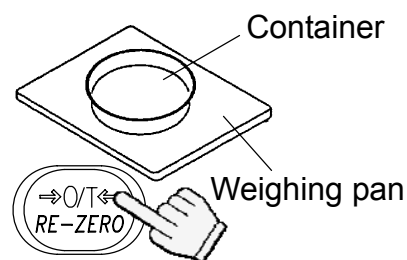

□ The **RE-ZERO key will zero the balance if the weight is within $\pm 2\%$ of the weighing capacity around the power-on zero point. The **ZERO** indicator ◀ turns on. When the weight exceeds $+2\%$ of the weighing capacity, it will be subtracted to zero as a tare weight. In this case the **ZERO** and **NET** marks turn on.**

⚠ Precautions during operation

- Make sure that the STABLE indicator is on whenever reading or storing a value.
- Do not press the keys with a sharp object such as a pencil.
- Do not apply a shock or a load to the pan that is beyond the weighing capacity.
- Keep the balance free from foreign objects such as dust or liquid.
- Calibrate the balance periodically to keep weighing accuracy. (See "7. CALIBRATION".)

5-6. Counting mode (pcs)

Weighs the sample pieces and calculate its unit weight. Using the sample unit weight, the scale counts the number of parts or items.

☐ As for the minimum unit weight acceptable, see the function setting “ U_{in} ”.

Selecting the counting mode

1. Press the **UNITS** key to select **pcs**.

(**pcs** :pieces)

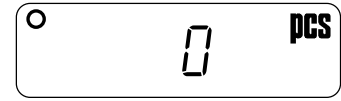

Storing the sample unit

2. Press the **SAMPLE** key to enter the sample unit weight storing mode.

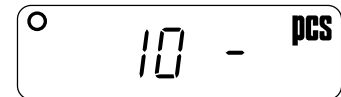
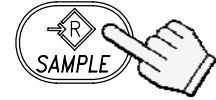

3. To select the number of samples, press the **SAMPLE** key. It may be set to 5, 10, 25, 50, or 100.

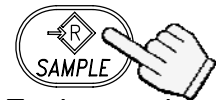

Each pressing switches the number of samples.



4. Place a tare container on the weighing pan, and press the **RE-ZERO** key. Confirm that the right side of the number of samples shows zero.

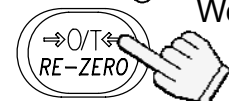
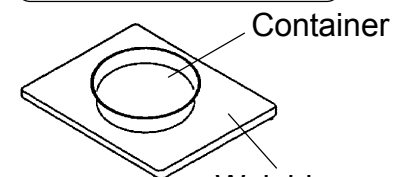

Confirm the display

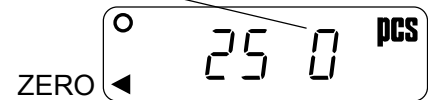

5. Place the number of samples specified on the pan. In this example, 25 pieces.

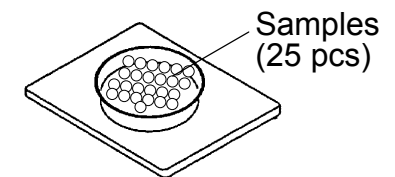

6. Press the **PRINT** key to calculate and store the unit weight. Remove the sample. The balance is set to count objects with this unit weight.



To store

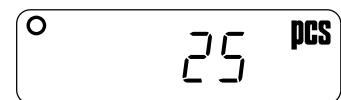

Counting the objects

7. Place the objects to be counted on the pan.

Counting mode using the ACAI function

ACAI™ (Automatic Counting Accuracy Improvement) is a function that improves the accuracy of the unit weight by increasing the number of samples as the counting process proceeds.

8. If a few more samples are added, the ACAI indicator is displayed. (To prevent an error, add three or more. The ACAI indicator will not be displayed if overloaded.)

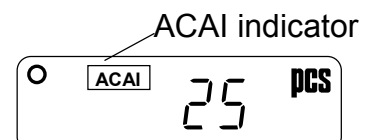

9. The balance re-calculates the unit weight while the ACAI indicator is blinking. Do not touch the balance or samples on the pan until the ACAI indicator turns off.
10. Counting accuracy is improved when the ACAI indicator turns off. Each time the above operation is performed, a more accurate unit weight will be obtained. There is no definite upper limit of ACAI range for the number of samples exceeding 100. Try to add the similar number of samples as displayed.

5-7. Percent mode (%)

Displays the weighing value in percentage compared to the reference (100%) weight.

Selecting the percent mode

1. Press the **UNITS** key to select %. (%:percent)

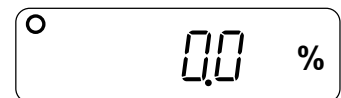

Storing the reference (100%) weight

2. Press the **SAMPLE** key to enter the reference weight storing mode.

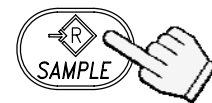

3. Press the **RE-ZERO** key to display 100 0%.

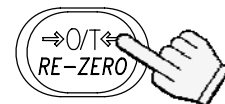

4. Place the sample to be set as the reference weight on the pan.

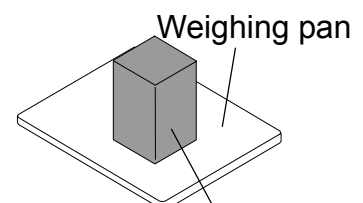

Sample corresponding to the 100% weight

5. Press the **PRINT** key to store the reference weight. Remove the sample.

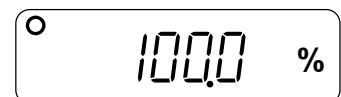

Reading the percentage

6. Place the object to be compared to the reference weight on the pan. The displayed percentage is based on 100% of the reference weight.

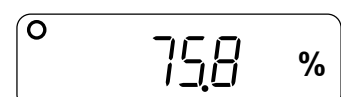
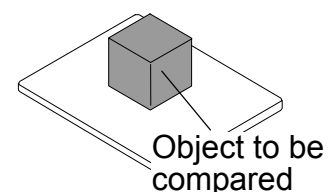

6. COMPARATOR

The results of the comparison are indicated by HI, OK or LO on the display.
The comparison is as follows:

$$LO < \text{Lower limit value} \leq OK \leq \text{Upper limit value} < HI$$

Operating conditions (see the function setting "[P]"):

- No comparison (comparator function disabled).
- Compares all data.
- Compares all stable data.
- Compares plus data except those near zero (plus data greater than +4d).
- Compares stable plus data except those near zero (stable plus data greater than +4d).
- Compares all data except those near zero (all data greater than +4d or less than -4d).
- Compares stable data except those near zero (stable data greater than +4d or less than -4d).

d = the smallest display division. e.g.: 4d = four display divisions

The upper limit and lower limit numerical values are common to each of the weighing, counting and percent mode. The example for EJ-120/200/300/410/610 is as follows.

Upper limit value "001010": "10.10g" "1010pcs" "101.0%"
Lower limit value "000990": "9.90g" "990pcs" "99.0%"

6-1. Setting example

This example will be "Compares plus data except those near zero".

Selecting a comparison mode

1. Press and hold the **SAMPLE** key to display **Func**.
(If the comparison mode is already set, press the **SAMPLE** key to go to "Entering the upper and lower limit values".)
2. Press the **PRINT** key, then the balance displays **PoFF X**.
3. Press the **SAMPLE** key several times to display **CP X**.
4. Press the **RE-ZERO** key several times to display **CP 3**.
5. Press the **PRINT** key to store the settings.
CP Hi appears after **End**.

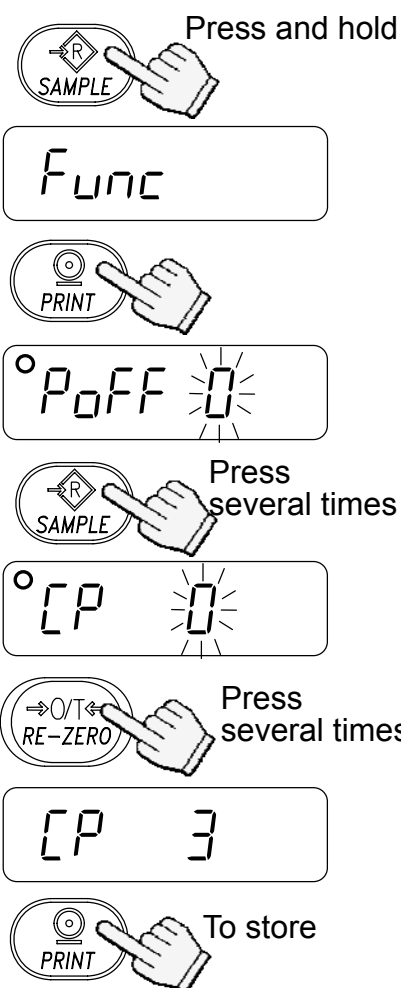

Entering the upper and lower limit values

6. With **[P H_i]** displayed, press the **[PRINT]** key. Enter the upper limit value using the following keys.

[SAMPLE] key To select the digit blinking to change.

[RE-ZERO] key To set the value of the digit selected. Hold down the key to switch the sign “+” and “-”. (“**N**” designates a negative value.)

[PRINT] key To store the value and proceed to the next step.

[UNITS] key To cancel the value and proceed to the next step.

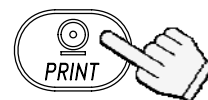
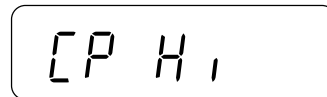

Set using the relevant keys



7. With **[P L_o]** displayed, press the **[PRINT]** key. Enter the lower limit value using the following keys.

[SAMPLE] key To select the digit blinking to change.

[RE-ZERO] key To set the value of the digit selected. Hold down the key to switch the sign “+” and “-” (see step 6).

[PRINT] key To store the value and proceed to the next step.

[UNITS] key To cancel the value and proceed to the next step.

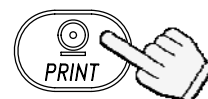
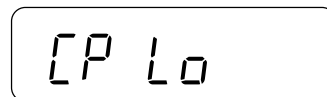

Set using the relevant keys

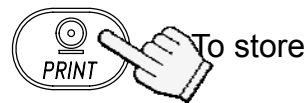
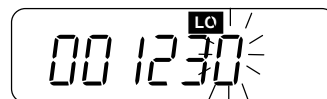

8. Press the **[PRINT]** key. **Unit** appears after **End**.

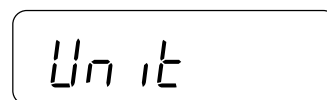
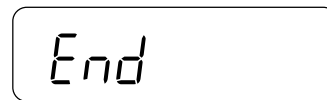

9. Press the **[UNITS]** key to return to the weighing mode.



Returns to the weighing mode

7. CALIBRATION

This function adjusts the balance for accurate weighing.
Perform a calibration in the following cases.

- When the balance is first used.
- When the balance has been moved.
- For regular calibration.

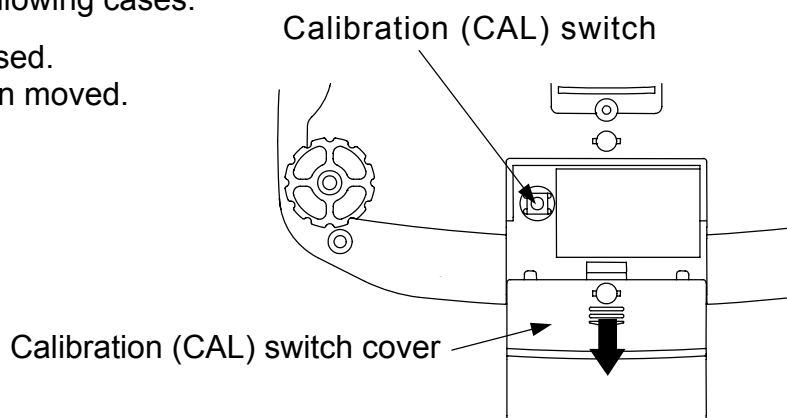

7-1. Calibration using a weight

- Prepare the calibration weight (sold separately) in advance.

1. Warm up the balance for at least half an hour with nothing on the pan.

2. Press and hold the calibration (CAL) switch until CAL appears, and release the switch.

3. The balance displays CAL 0.

To change the calibration weight value, proceed to step 4.

To use the calibration weight value in the balance memory, proceed to step 5.

4. Press the SAMPLE key. The display shows the calibration weight value in “gram” that is stored in the balance. Use the following keys to change the value.

SAMPLE key To select the digit blinking to change.

RE-ZERO key To set the value of the digit selected.

PRINT key To store the value and return to step 3.

UNITS key To cancel the value and return to step 3.

 Press and hold the CAL switch.

CAL

Release the CAL switch.



CAL 0

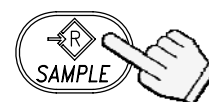

0.60000g

Set the weight using the relevant keys.

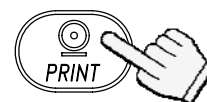

CAL 0

5. At step 3, pressing the **PRINT** key to weigh the zero-point value. Do not touch the pan during weighing.

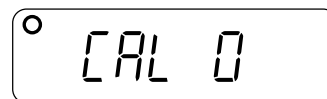
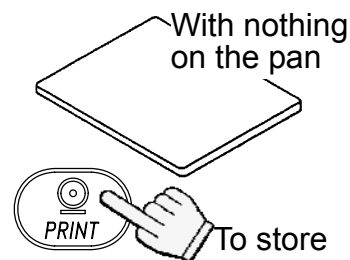

6. Place the calibration weight with the same value as displayed on the pan. Press the **PRINT** key to weigh it. Do not touch the pan during weighing.

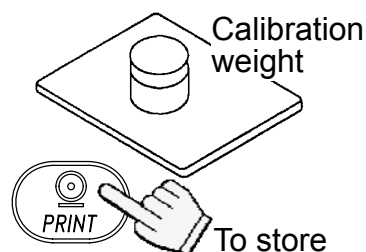

7. **End** appears. Remove the weight from the pan. When the GLP output (function setting "info 1" or "info 2") is selected, **GLP** is displayed. The calibration report is output and **End** appears again. Press the CAL switch or **UNITS** key to return to the weighing mode.

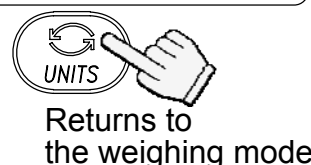
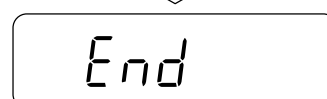
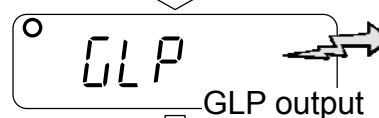
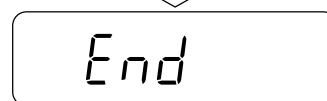

Note

The value set in step 4 is stored in memory even after the power is switched off.

If the balance is to be moved to other places, set the gravity acceleration value of the area where the calibration using a weight is to be done, and calibrate the balance according to the procedure above. See the next section to set the value.

7-2. Gravity acceleration correction

When the balance is first used or has been moved to a different place, it should be calibrated using a calibration weight.

But if the calibration weight cannot be prepared, the gravity acceleration correction will compensate the balance. Change the gravity acceleration value of the balance to the value of the area where the balance will be used. See the gravity acceleration map appended to the end of this manual.

□ Note

Gravity acceleration correction is not required when the balance is calibrated using a calibration weight at the place where the balance is to be used.

1. Press and hold the calibration (CAL) switch until CAL appears, and release the switch.
2. The balance displays CAL 0.
3. Press the RE-ZERO key.
The display shows the gravity acceleration value stored in the balance.
Use the following keys to change the value.

SAMPLE key	To select the digit blinking to change.
RE-ZERO key	To set the value of the digit selected.
PRINT key	To store the value and return to step 2.
UNITS key	To cancel the value and return to step 2.
4. After setting the value, press the PRINT key.
CAL 0 is displayed again.
5. If it is necessary to calibrate the balance using a calibration weight, go to step 4 of 7-1.
To finish the setting, press UNITS key.
6. End appears and the balance returns to the weighing mode.



Press and hold the CAL switch.

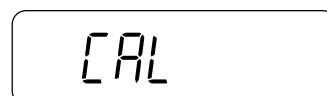

Release the CAL switch.

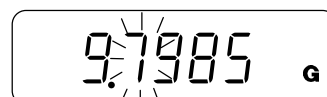
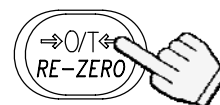
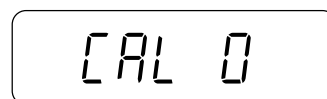

Set the value using the relevant keys.

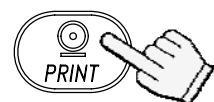

To store

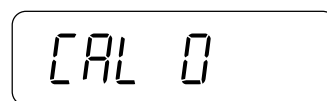

Returns to the weighing mode

8. FUNCTIONS

8-1. Key operation

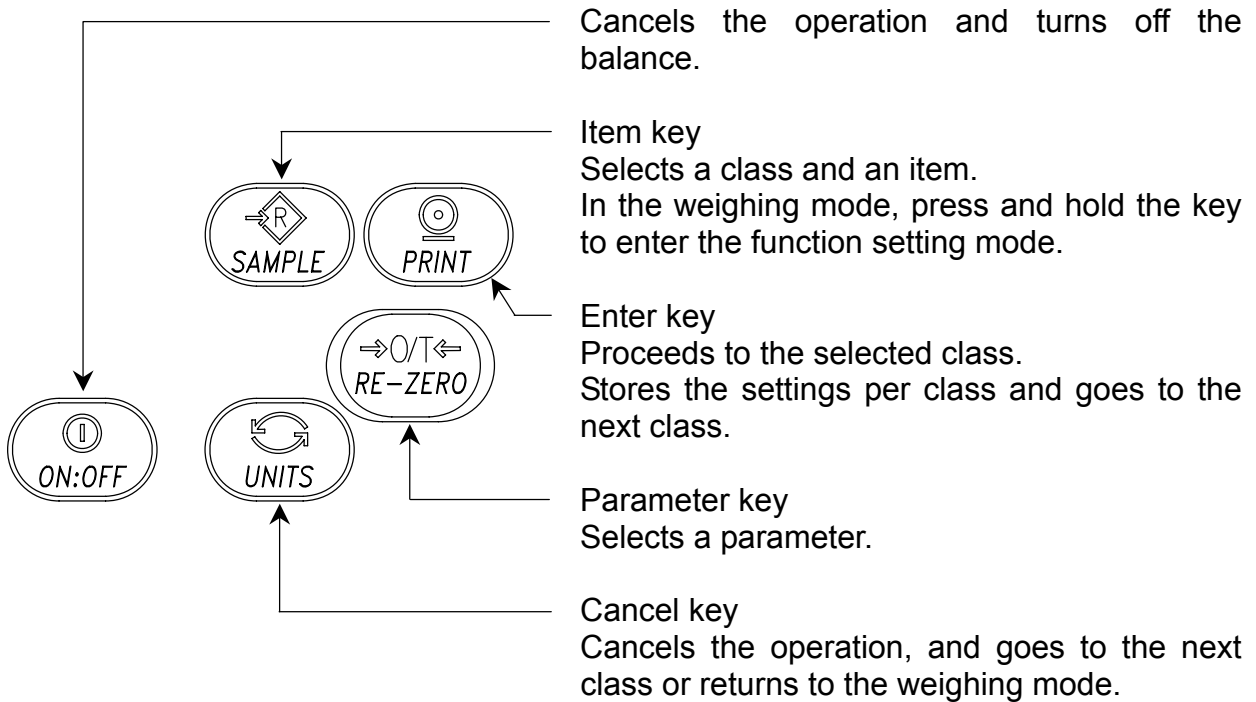

8-2. Entering the function setting mode

In the weighing mode, press and hold the **SAMPLE** key to enter the function setting mode and display **Func**. Each time the **SAMPLE** key is pressed, the class appears one after another.

Once the class is selected, the set items are available for selection. (See "Function list".)

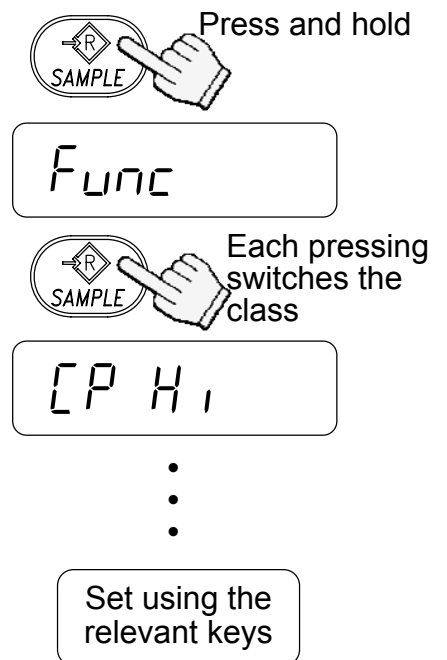

8-3. Setting example

To set auto power-off function to “Enabled”, and the ACAI function to “Disabled”.

1. Press and hold the **SAMPLE** key to display **Func**.

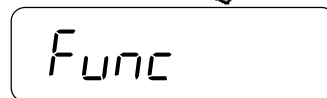

2. Press the **PRINT** key. The balance displays **PoFF 0**.

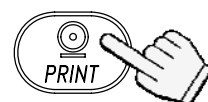

3. Press the **RE-ZERO** key to display **PoFF 1**.

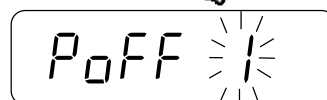
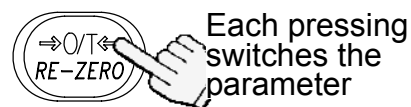

4. Press the **SAMPLE** key several times to display **ACA, 1**.

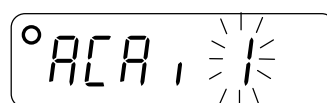

5. Press the **RE-ZERO** key to select **ACA, 0**.

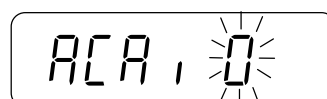

6. Press the **PRINT** key to store the parameters. **CPH, 1** appears after **End**.

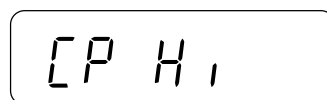
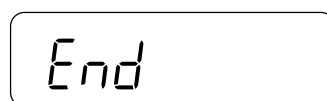
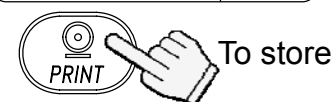

7. Press the **UNITS** key to return to the weighing mode.

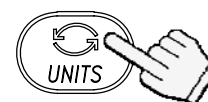

Returns to the weighing mode

8-4. Storing weighing units

It is possible to store the weighing units that will be actually used from the units available. For the units available, see "5-3. Units".

Select and store the weighing units as described below:

1. Press and hold the **SAMPLE** key to display **Func**.

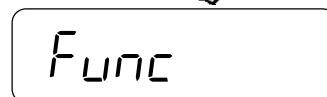

2. Press the **SAMPLE** key several times to display **Unit**.

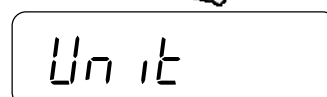

3. Press the **PRINT** key.

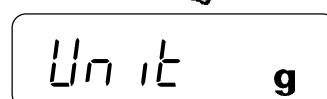
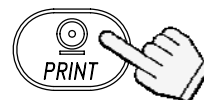

4. Press the **SAMPLE** key to display a weighing unit to be stored.

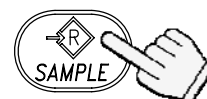

Each pressing switches the units available in the order described on 5-3.

5. Press the **RE-ZERO** key to select the weighing unit. The selected weighing unit is shown with the STABLE indicator.

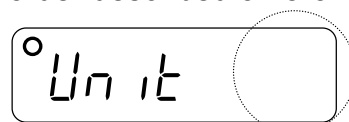

- At this stage, the weighing unit is not stored in memory.



6. Repeat steps 4. and 5. to store all weighing units to be used.

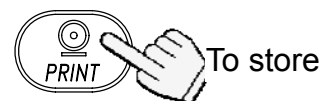

7. Press the **PRINT** key to store the selected weighing units in memory.

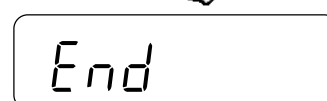

id appears after **End**.



8. Press the **UNITS** key to return to the weighing mode.



Returns to the weighing mode

Note

When the balance is switched on, it starts with the unit that was stored first at step 5.

8-5. Function list

Class	Item	Parameter	Description		
<i>Func</i>	<i>PoFF</i> Auto power-off	◆ 0	Auto power-off disabled	Automatically power off	
		1	Auto power-off enabled		
	<i>Cond</i> Response	0		Fast / sensitive	Software filtering
		1			
		◆ 2			
		3			
		4		Slow / stable	
	<i>St-b</i> Stability band width	0	Stable when within $\pm 0.5d/0.5s$	Conditions to turn on the STABLE indicator	
		◆ 1	Stable when within $\pm 1d/0.5s$		
		2	Stable when within $\pm 2d/0.5s$		
	<i>trc</i> Zero tracking	0	Disabled	Tracking zero shift	
		◆ 1	Enabled		
	<i>Pnt</i> Decimal point	◆ 0	Point (.)	Decimal separator	
		1	Comma (,)		
	<i>CP</i> Comparator mode	◆ 0	Comparator disabled	Conditions to compare. d = the minimum display division	
		1	Compares all data		
		2	Compares all stable data		
		3	Compares plus data $> +4d$		
		4	Compare stable plus data $> +4d$		
		5	Compares data $> +4d$ or $< -4d$		
	<i>Prt</i> Data output mode	0	Command and stream modes	Auto-print A: + data Auto-print B: +/- data	
		◆ 1	Command and PRINT key		
		2	Command, PRINT key and auto-print A		
		3	Command, PRINT key and auto-print B		
		4	Command mode only		
	<i>PUSE</i> Data output pause	◆ 0	No pause (general equipment)	Interval between continuous data	
		1	1.6 seconds (for AD-8121)		
	<i>inFo</i> GLP output	◆ 0	No output	GLP output format	
		1	AD-8121 format (*)		
		2	General format		
<i>bPS</i> Baud rate	◆ 0	2400 bps			
	1	4800 bps			
	2	9600 bps			
	3	1200 bps			
<i>btPr</i> Data and parity	◆ 0	7 bits, even parity			
	1	7 bits, odd parity			
	2	8 bits, non parity			

◆ Factory setting

(*) When the AD-8121 format is selected, the interval between data is 1.6 seconds regardless of the setting "PUSE".

Class	Item	Parameter	Description	
<i>F_{unc}</i>	<i>ACAI</i> ACAI function	0	ACAI disabled	If "0" is set, no additional samples required.
		◆ 1	ACAI enabled	
	<i>Min</i> Minimum unit weight	◆ 0	1 d	d = the minimum display division
		1	1/10 d	
		2	total sample weight ≥ 5d (**)	
	<i>S_{PL}</i> Sample number	◆ 0	10 pcs	The number of samples shown first when entered into the unit weight storing mode
		1	25 pcs	
		2	50 pcs	
		3	100 pcs	
		4	5 pcs	
	<i>L_{in}</i> Liquid density input	◆ 0	Water temperature	The way to input liquid density.
		1	Liquid density	
	<i>LEUP</i> LCD Backlight control	0	Always off	To control how the LCD backlight turns off. Weight change or key operation will turn the backlight on.
		1	Turns off after 5 seconds	
		2	Turns off after 10 seconds	
		◆ 3	Turns off after 30 seconds	
		4	Turns off after 60 seconds	
	5	Always on		
<i>CPH₁</i>	Comparator upper limit		Setting the upper limit value	See
<i>CPL₀</i>	Comparator lower limit		Setting the lower limit value	"6. COMPARATOR"
<i>Unit</i>	Weighing units to be displayed		Sets to display units	See "8-4. Storing weighing units"
<i>ID</i>	ID number for GLP output		Sets the ID number	See "10. ID NUMBER AND GLP"

◆ Factory setting

(**) Even if the weight display is "5d", the sample weight may not be accepted. This is because the weight display data is rounded off internally.

9. OPTIONS

The following options are available for the EJ series:

- EJ-02 USB interface
- EJ-03 RS-232C serial interface
- EJ-07 Underhook for EJ-3000 / EJ-4100 / EJ-6100
- EJ-08 Underhook for EJ-1500 / EJ-2000
- EJ-11 Breeze break
- EJ-12 Carrying case
- EJ-13 Density Determination Kit for EJ-120 / EJ-200 / EJ-300 / EJ-410 / EJ-610

9-1. EJ-02 USB Interface

❑ EJ-02 cannot be used together with EJ-03.

- The EJ-02 is installed to the same slot as EJ-03 and see “9-2. EJ-03 RS-232C serial interface”.
- The EJ-02 will be used to transmit the weight data (numerical value only) uni-directionally to a personal computer via USB.
- The EJ-02 can transmit the weight data (numerical value only) directly to other application software such as Microsoft Excel, Word, memo pad, and so on.
- The driver is not necessary to install.
- The EJ-02 cannot be used for bidirectional communication.

9-2. EJ-03 RS-232C serial interface

This interface allows the EJ series to be connected with a multifunction printer or a personal computer.

❑ EJ-03 cannot be used together with EJ-02.

- The RS-232C interface has the following four modes.

Stream mode	Outputs data continuously.
Key mode	Outputs data by pressing the PRINT key.
Auto-print mode	Outputs data which meets the conditions of auto-print.
Command mode	Controls the balance using commands from a computer.
- Set the parameters of the data format ($bP\zeta$ and $b\zeta P_r$) and data output mode ($P_r\zeta$), as necessary.
- Use a D-sub 9 pin cable (straight type) to connect with a computer.
Optional cable: AX-KO2466-200 D-Sub 9 pin / 9 pin cable with 2 m long.

EJ-03 Installation

1. Turn off the balance and disconnect the AC adapter if used.
2. Remove the cover of the option slot on the rear by pressing and lowering it down.
3. Connect the connector in the slot to the EJ-03 unit and insert it into the slot.

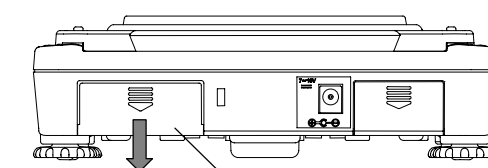

Press and lower down the cover.

Option slot for EJ-02 / EJ-03

- Secure the EJ-02 with the screws supplied with the EJ-03.

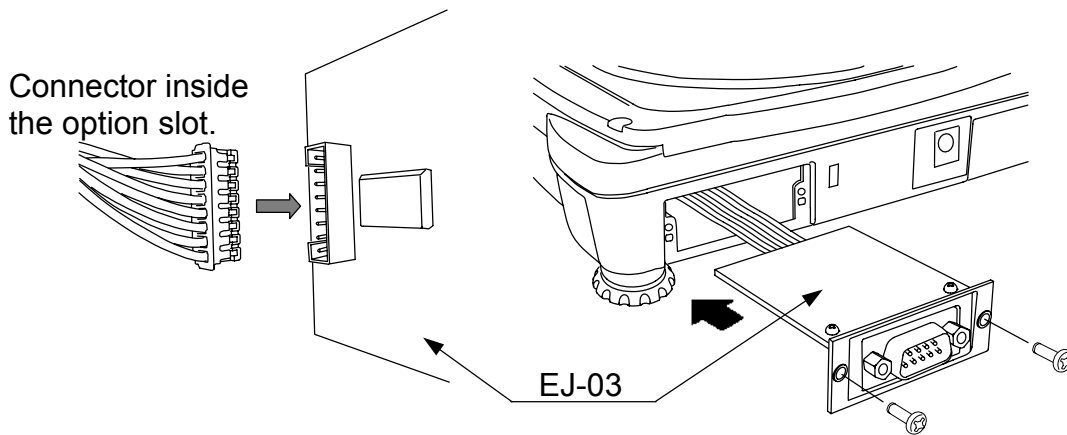

Interface specifications

Transmission system	EIA RS-232C
Transmission form	Asynchronous, bi-directional, half-duplex
Data format	Baud rate: 1200, 2400, 4800, 9600 bps
	Data: 7 bits + parity 1bit (even or odd) or 8 bits (non-parity)
	Start bit: 1 bit
	Stop bit: 1 bit
	Code: ASCII
	Terminator: C_{RLF} (C_R : 0Dh, L_F : 0Ah)

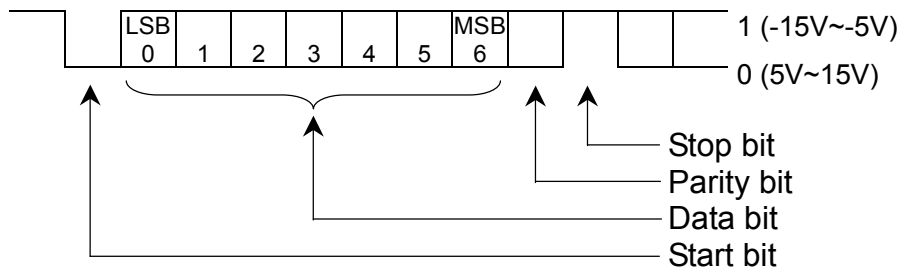

Pin connections

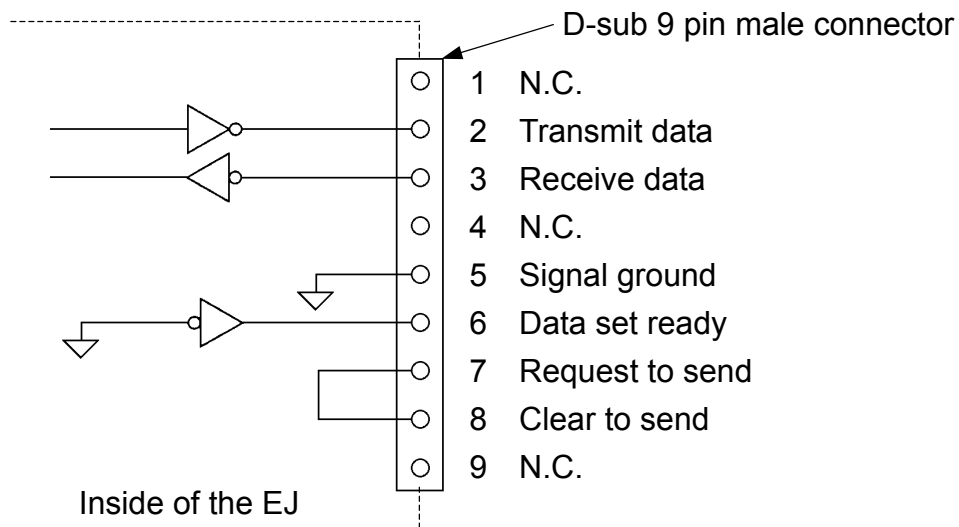

The interface is designated as DCE (Data Communication Equipment).

Data format

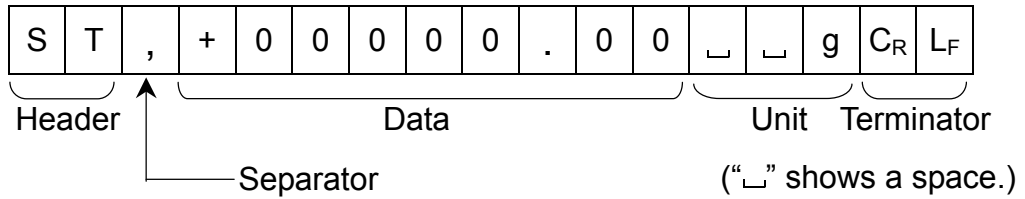

- ❑ There are four types of headers:
 - ST : Stable weighing data (including % data)
 - QT : Stable counting data
 - US : Unstable weighing data (including count and %)
 - OL : Out of weighing range (Over)

- ❑ The data is normally 9 digits including a decimal point and a sign.

- ❑ There are 14 types of units:
 - _ _ g : Weighing data “gram”
 - _ P C : Counting data “pcs”
 - _ _ % : Percentage data “%”
 - _ o z : Weighing data “decimal ounce”
 - _ l b : Weighing data “decimal pound”
 - o z t : Weighing data “troy ounce”
 - _ c t : Weighing data “carat”
 - mom : Weighing data “momme”
 - d w t : Weighing data “penny weight”
 - _GN : Weighing data “grain”
 - _ _ N : Force data “Newton”
 - _ t l : Weighing data “tael”
 - _ _ t : Weighing data “tola”
 - _DS : Calculated density (specific gravity) value

- ❑ The terminator is always C_RL_F.

- ❑ Example of output data:

Weighing data “gram”	S T , + 0 0 1 2 3 4 . 5 _ _ g C _R L _F
Counting data	Q T , + 0 0 0 1 2 3 4 5 _ P C C _R L _F
Percentage data	S T , + 0 0 0 1 2 3 . 4 _ _ % C _R L _F
Out of range “gram” (+)	O L , + 9 9 9 9 9 9 . 9 _ _ g C _R L _F
Out of range “pcs” (-)	O L , - 9 9 9 9 9 9 . 9 _ P C C _R L _F

Data output mode

- ❑ Stream mode

Set the function “Prt 0”.

The balance outputs the current display data. The data-update rate is approximately 10 times per second. This rate is the same as the display-update.

The balance does not output data while it is in the setting mode.

Key mode

Set the function "Print 1, 2 or 3".

When the key is pressed while the weighing data is stable (the STABLE indicator is on), the balance transmits the data. When the data is transmitted, the display will blink one time.

Auto-print mode A

Set the function "Print 2".

The balance transmits the weighing data when the display is stable (the STABLE indicator is on) and the data is greater than +4d.

The next output can be obtained after the display returns below +4d.

Auto-print mode B

Set the function "Print 3".

The balance transmits the weighing data when the display is stable (the STABLE indicator is on) and the data is greater than +4d or less than -4d.

The next output can be obtained after the display returns between -4d and +4d.

Command mode

In the command mode, the balance is controlled by commands that come from the personal computer and so on.

Command list

- Command to request the current weighing data.

Command

Reply

- Command to zero or tare the balance (same as the key).

Command

Reply

- Command to change the weighing units (same as the key).

Command

Reply

9-3. EJ-07 / EJ-08 Underhook

By attaching the underhook to the bottom of the balance, large objects that are difficult to load on the weighing pan can be weighed, and the density (specific gravity) of objects may be measured. Refer to the "9-6. EJ-13 Density Determination Kit" for the information about the density measurement.

- ❑ **EJ-07 is for use with the EJ-3000 / EJ-4100 / EJ-6100.**
- ❑ **EJ-08 is for use with the EJ-1500 / EJ-2000.**
- ❑ **The calibration with a weight being hung on the hook is required for an accurate weighing.**

EJ-07 / EJ-08 Installation

Open the cap on the bottom of the balance, and screw the underhook into the mounting hole.

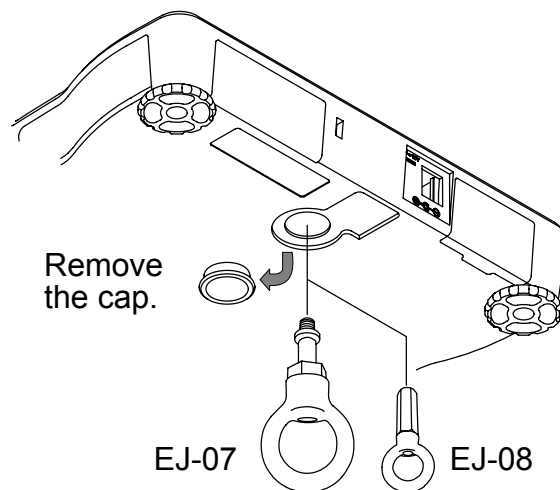
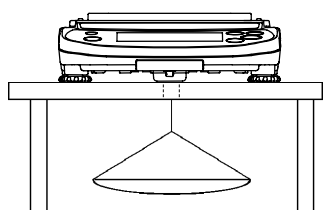

Caution

- ❑ **Do not apply excessive force to the underhook.**
- ❑ **When not in use, remove the underhook and attach the cap to prevent dust from getting into the balance.**

9-4. EJ-11 Breeze break

EJ-11 will be used mainly for min. display 0.01 g models. But all of EJ series can use this option unit.

- ❑ Remove the fixing frame out.
- ❑ Attach the breeze break frame instead of the fixing frame.
- ❑ Attach the breeze break to the balance.

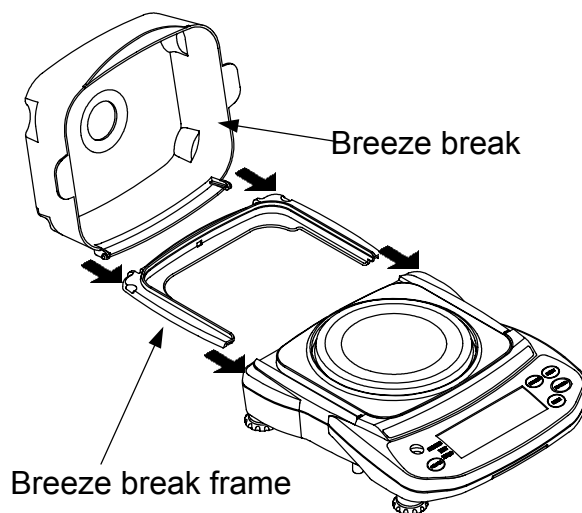
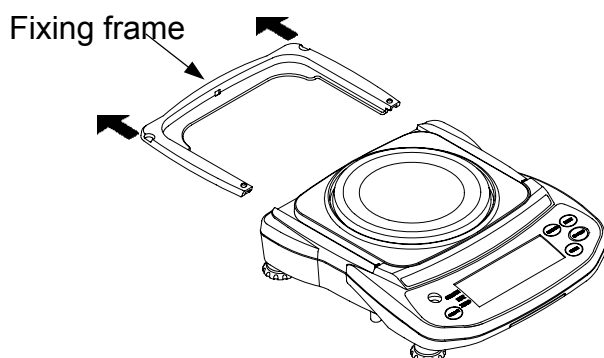

9-5. EJ-12 Carrying case

EJ-12 is available for the convenience of carrying the balance by hand. However, note that because these balances are precision equipment, they will not be able to withstand excessive shock, such as being dropped.

9-6. EJ-13 Density Determination Kit

Using this option and calculation program, the balance can determine the density (specific gravity) of a sample.

EJ-13 Installation

- ❑ Push the fixing frame out, and remove the weighing pan.
- ❑ Attach the beaker stand to the balance and fit the pan stand to the pan support of the balance.

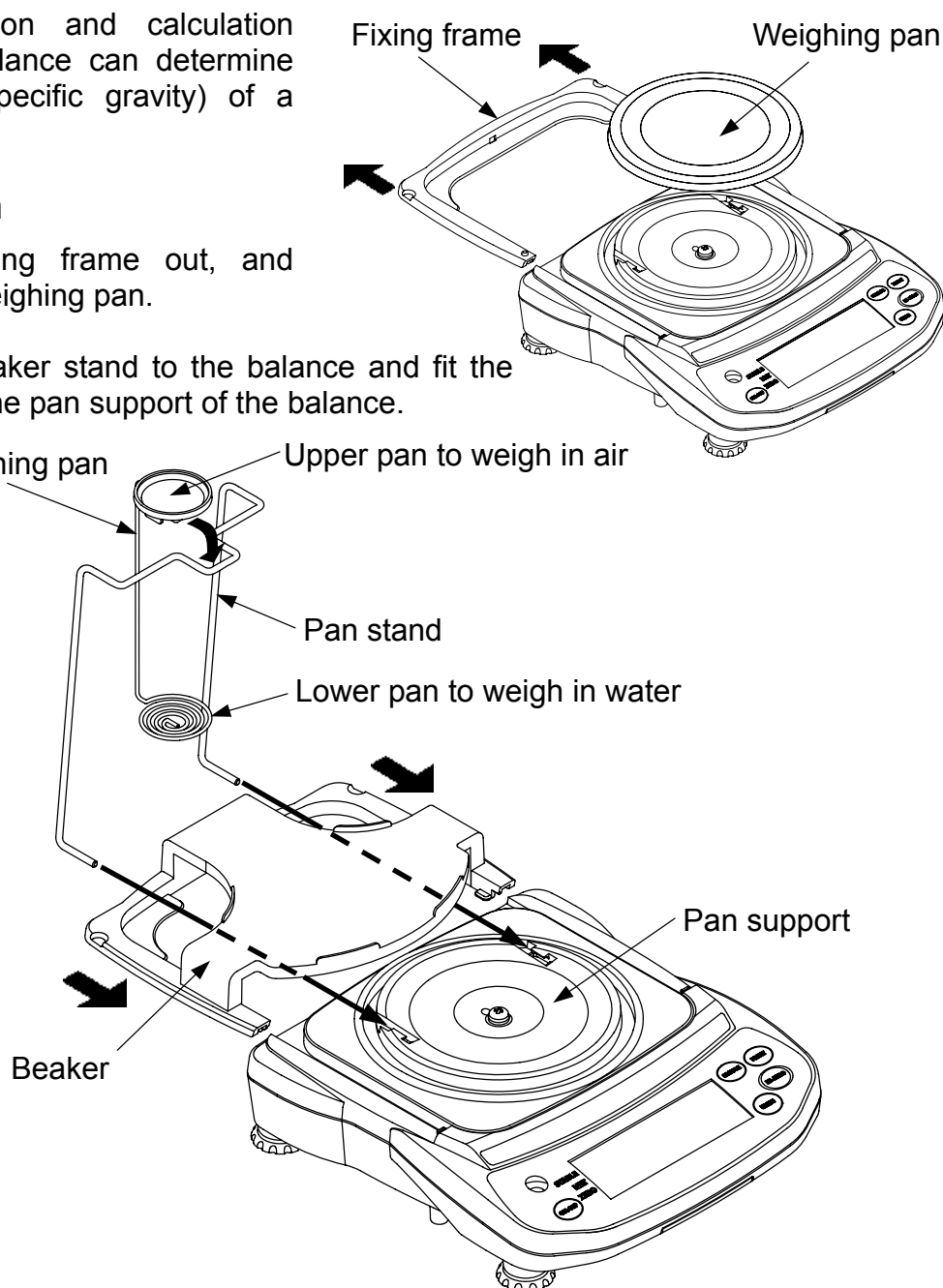

- ❑ Place a beaker filled with water on the beaker stand and place the sample weighing pan on top of the pan stand.

Density (specific gravity) measurement

- ❑ The density of a liquid can be changed and there are two ways of setting. One is to set the water temperature and the other is to set density value directly.
- ❑ The factory setting for density of a liquid is 25 °C as water temperature (the density value $\rho = 0.99704 \text{ (g/cm}^3\text{)}$ is used to calculate).
- ❑ The density (specific gravity) is calculated by the following formula.

$$S = \frac{A}{A-B} \times \rho$$

S: Density (specific gravity) of a sample
A: Weight in air
B: Weight in liquid
 ρ : Density of liquid (water)

- ❑ The result is shown with two decimal places.

Change the function table

Selecting a way to set the density of a liquid

Select the liquid density input method from the function table below. The function table is available only when the density measurement mode is selected.

Class	Item	Parameter	Description
Func	Ld in Liquid density input	♦ 0	Water temperature
		1	Liquid density

The way to input liquid density.

♦ Factory setting

Setting the density of a liquid

1. Press the **UNITS** key to select **SG**.

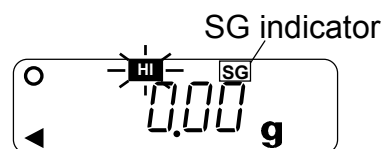

2. Press and hold the **UNITS** key to display liquid density input mode.

Ld in = 0: Water temperature
This shows 25 °C.

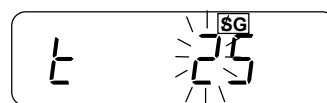

Ld in = 1: Liquid density
This shows $\rho = 1.0000$ (g/cm³).



3. Using the **RE-ZERO** (to increment the value) and **SAMPLE** key (to shift the selected digit), set the value and press the **PRINT** key to store.

To cancel the setting procedure and return to the density measuring mode, press the **UNITS** key. The input value is not stored.

The relation between the water temperature and density is shown below.

°C	+0	+1	+2	+3	+4	+5	+6	+7	+8	+9
0	0.99984	0.99990	0.99994	0.99996	0.99997	0.99996	0.99994	0.99990	0.99985	0.99978
10	0.99970	0.99961	0.99949	0.99938	0.99924	0.99910	0.99894	0.99877	0.99860	0.99841
20	0.99820	0.99799	0.99777	0.99754	0.99730	0.99704	0.99678	0.99651	0.99623	0.99594
30	0.99565	0.99534	0.99503	0.99470	0.99437	0.99403	0.99368	0.99333	0.99297	0.99259
40	0.99222	0.99183	0.99144	0.99104	0.99063	0.99021	0.98979	0.98936	0.98893	0.98849
50	0.98804	0.98758	0.98712	0.98665	0.98618	0.98570	0.98521	0.98471	0.98422	0.98371
60	0.98320	0.98268	0.98216	0.98163	0.98110	0.98055	0.98001	0.97946	0.97890	0.97834
70	0.97777	0.97720	0.97662	0.97603	0.97544	0.97485	0.97425	0.97364	0.97303	0.97242
80	0.97180	0.97117	0.97054	0.96991	0.96927	0.96862	0.96797	0.96731	0.96665	0.96600
90	0.96532	0.96465	0.96397	0.96328	0.96259	0.96190	0.96120	0.96050	0.95979	0.95906

Example of density measurement

Selecting the SG measurement mode

1. Press the **UNITS** key to select **SG**.
(The weight unit is "g".)

Measuring weight in air. SG indicator



The weighing unit is "g".

The display shows that **HI** blinks and the balance is measuring weight in air.

When the display does not show zero, press the **RE-ZERO** key to set the display to zero.

- Place a sample on the upper pan.
- Wait for the STABLE indicator to be displayed and press the **SAMPLE** key to store the weight in air.

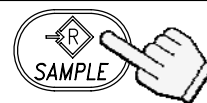

Measuring weight in water.

- The display shows that **LO** blinks and the balance starts to measure weight in water.



- Place the sample on the lower pan in water.

- Adjust the amount of water so that the sample is about 10 mm below water surface.

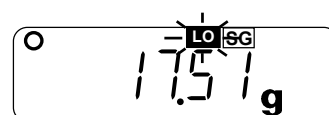

- Wait for the STABLE indicator to be displayed and press the **SAMPLE** key. Then the balance reads the weight in water and shows the density (specific gravity) of the sample.

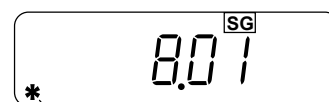
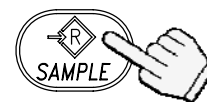

* The display shows the density.

- To continue the specific gravity measurement, press the **SAMPLE** key again. To exit this measurement, press the **UNITS** key.

To weigh in air.

To weigh in water.

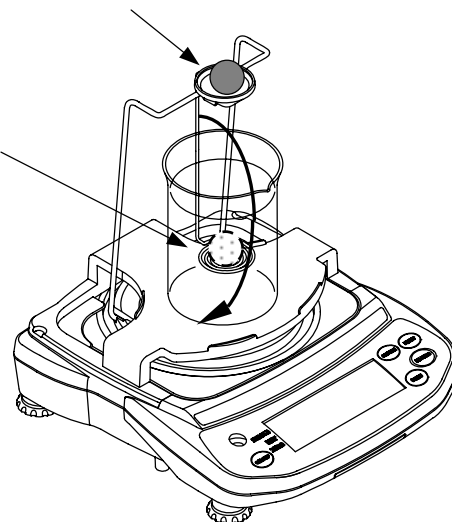

10. ID NUMBER AND GLP

- ❑ The ID number is used to identify the balance when Good Laboratory Practice (GLP) is used.
- ❑ The ID number is held in memory even if power to the balance is switched off.
- ❑ The following GLP data is transmitted to a printer or a computer using the optional RS-232C interface.
 - The result of calibration (“Calibration report”)
 - The result of calibration test (“Calibration test report”)
 - The “Title block” and “End block” for GLP data
- ❑ The GLP output format includes the balance manufacturer name, model number, serial number, ID number and space for signature.
- ❑ When used with the AD-8121B, the date and time can be printed (GLP output format *inF₀ = 1*).

10-1. Setting the ID number

1. Press and hold the **SAMPLE** key to display `Func`.

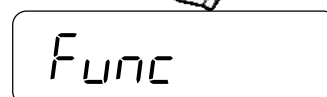

2. Press the **SAMPLE** key several times to display `id`.

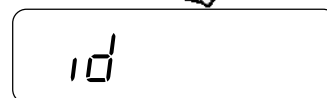

3. Press the **PRINT** key. Enter the ID number using the following keys.

SAMPLE key To select the digit blinking to change.

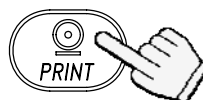

RE-ZERO key To set the character of the digit selected. See the table below for the “display character set”.



PRINT key To store the value and proceed to the next step.

Set using the relevant keys

UNITS key To cancel the value and proceed to the next step.

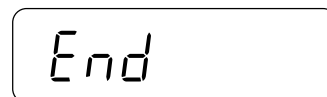

4. When the above operation has completed, `Func` appears after `End`.

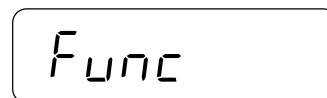

5. Press the **UNITS** key to return to the weighing mode.



Returns to the weighing mode

Display character set

0	1	2	3	4	5	6	7	8	9	-	□	A	B	C	D	E	F	G	H	I	J	K	L	M	N	O	P	Q	R	S	T	U	V	W	X	Y	Z
0	1	2	3	4	5	6	7	8	9	-	□	A	b	c	d	E	F	G	H	,	u	v	L	n	o	P	q	r	S	t	U	u	v	W	X	Y	Z

“□” : Space

10-2. Output example

- ❑ To print the GLP report, set the function “*Info 1*” and use MODE 3 of the printer AD-8121B.
- ❑ To output the GLP report to a personal computer, set the function “*Info 2*”.

Data format for “calibration report”

Perform calibration using a weight. Then the balance will output a calibration report. See “7-1. Calibration using a weight” about the calibration.

AD-8121 format “*Info 1*”

```

      A & D
MODEL  EJ-300
S/N    1234567
ID     ABCDEF
DATE   09/03/21
02:53:21 PM
CALIBRATED(EXT.)
CAL.WEIGHT
      +300.00 g
SIGNATURE
-----
  
```

← Manufacturer →
 ← Model →
 ← Serial number →
 ← ID number →
 ← Date →
 ← Time →
 ← Calibration executed →
 ← Calibration weight →
 ← Signature →

General format “*Info 2*”

```

_____A_&_D<CRLF>
MODEL_____EJ-300<CRLF>
S/N_____1234567<CRLF>
ID_____ABCDEF<CRLF>
DATE<CRLF>
<CRLF>
TIME<CRLF>
<CRLF>
CALIBRATED (EXT. )<CRLF>
CAL. WEIGHT<CRLF>
_____+300.00__g<CRLF>
SIGNATURE<CRLF>
<CRLF>
<CRLF>
-----<CRLF>
<CRLF>
<CRLF>
  
```

Data format for “calibration test report”

Perform calibration test using a weight. Then the balance will output a calibration test report. See “10-3. Calibration test using a weight” about the calibration test.

AD-8121 format “*Info 1*”

```

      A & D
MODEL  EJ-300
S/N    1234567
ID     ABCDEF
DATE   09/03/21
03:15:40 PM
CALIBRATED(EXT.)
ACTUAL
      0.00 g
      +299.99 g
TARGET
      +300.00 g
SIGNATURE
-----
  
```

← Manufacturer →
 ← Model →
 ← Serial number →
 ← ID number →
 ← Date →
 ← Time →
 ← Calibration test →
 ← Zero value →
 ← Weight value →
 ← Target weight value →
 ← Signature →

General format “*Info 2*”

```

_____A_&_D<CRLF>
MODEL_____EJ-300<CRLF>
S/N_____1234567<CRLF>
ID_____ABCDEF<CRLF>
DATE<CRLF>
<CRLF>
TIME<CRLF>
<CRLF>
CAL. TEST (EXT. )<CRLF>
ACTUAL<CRLF>
_____0.00__g<CRLF>
_____+299.99__g<CRLF>
TARGET<CRLF>
_____+300.00__g<CRLF>
SIGNATURE<CRLF>
<CRLF>
<CRLF>
-----<CRLF>
<CRLF>
<CRLF>
  
```

_ :Space, ASCII 20h
 CR :Carriage return, ASCII 0Dh
 LF :Line feed, ASCII 04Ah

“Title block” and “End block”

- ❑ When a weight value is recorded as the GLP data, “Title block” and “End block” are added at a group of weight values in the GLP report.
 - ❑ To output the GLP report to the printer AD-8121B , use MODE 3 of it.
1. With the weight data displayed, press and hold the **PRINT** key until **Start** is displayed. Then, the balance outputs the “Title block”.
 2. The balance can output the weighing data by pressing the **PRINT** key or selecting the auto-print mode.
 3. Press and hold the **PRINT** key until **RecEnd** is displayed. Then, the balance outputs the “End block” and shows **End**.
 4. Press the **UNITS** key to return to the normal weighing mode.

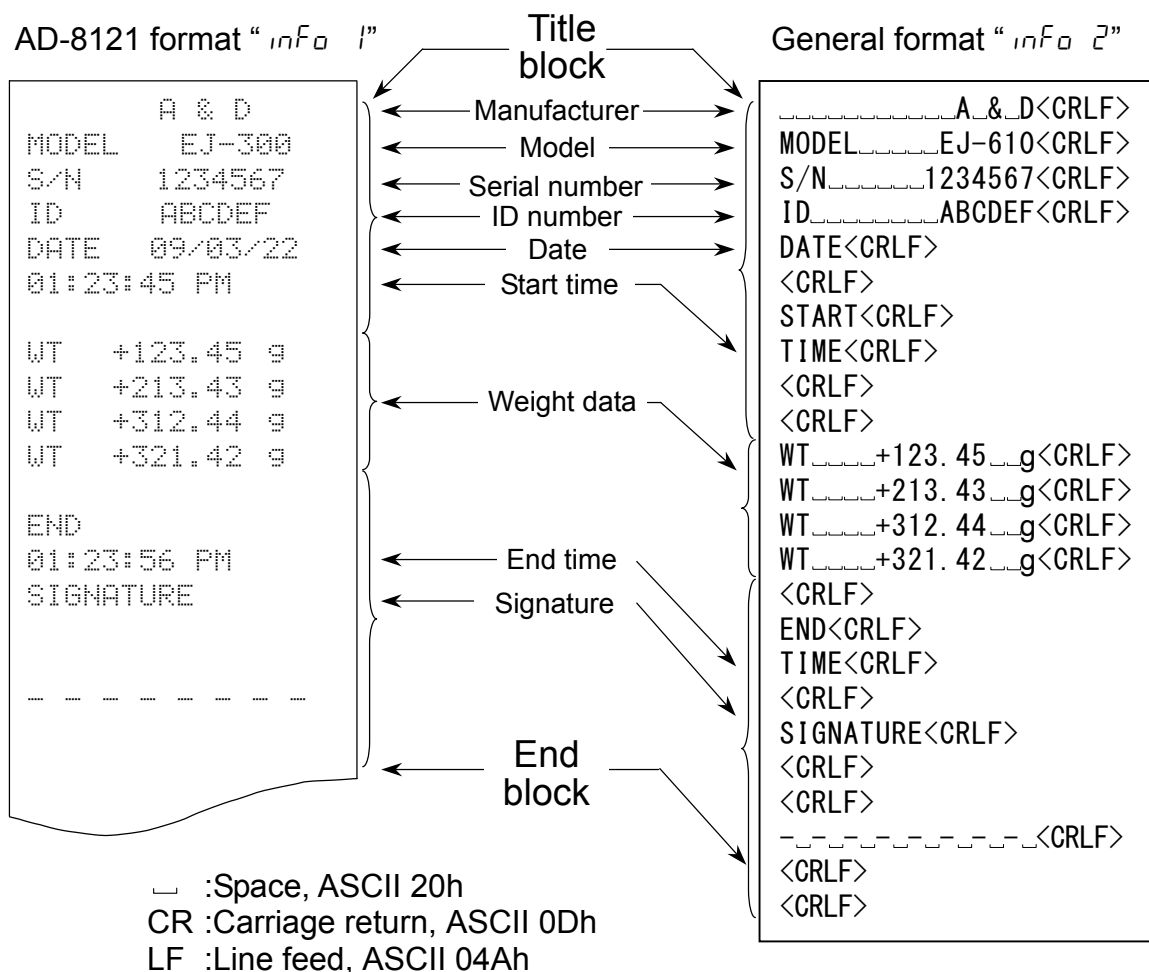

10-3. Calibration test using a weight

- ❑ Calibration test is to confirm the weighing accuracy using a weight and output the results as GLP report.
- ❑ Set the function setting “Info 1” or “Info 2” to perform the calibration test.
- ❑ Calibration test does not perform actual calibration but is only to test.

1. Press and hold the calibration (CAL) switch.
CC appears after **CAL**. Release the switch when **CC** is displayed.

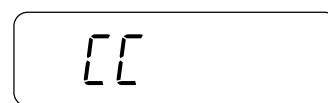

Release the CAL switch.

(Pressing and holding the **SAMPLE** and **PRINT** keys will also display **CC**.)



2. [[0 is displayed.

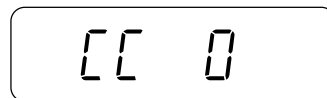

3. If necessary to change the weight value to check, press the SAMPLE key and change the weight value using the following keys.

SAMPLE key To select the digit blinking to change.

RE-ZERO key To set the value of the digit selected.

PRINT key To store the value and return to step 2.

4. At step 2, press the PRINT key. The zero point is weighed and the weighed value is displayed for a few seconds.

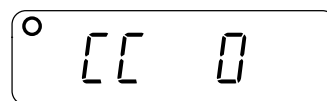
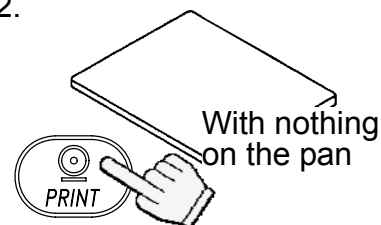

The weighed data is shown with "g".

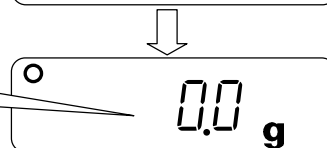

5. Place the displayed weight on the pan and press the PRINT key to weigh it. The weighed value is displayed for a few seconds.

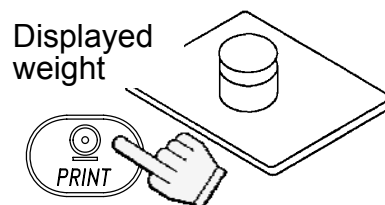

The weighed data is shown with "g".

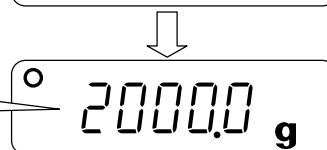

6. End appears.

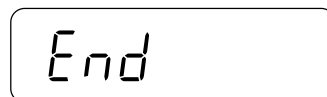

7. GLP is displayed and calibration test report is output.

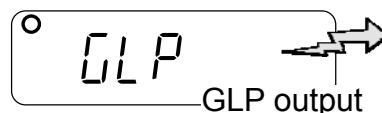

8. End appears again. Remove the weight and press the MODE key to return to the weighing mode.

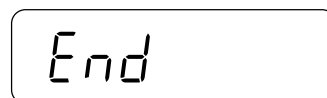

Returns to the weighing mode

11. MAINTENANCE

11-1. Notes on maintenance

- ❑ Do not disassemble the balance. Contact your local A&D dealer if your balance needs service or repair.
- ❑ Please use the original package for transportation.
- ❑ Do not use organic solvents to clean the balance. Use a warm lint free cloth dampened with a mild detergent.
- ❑ To clean around the pan support, refer to the drawings below.

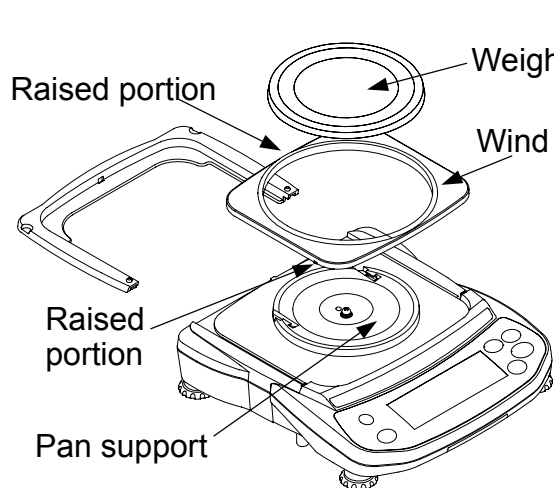

EJ-120 / EJ-200 / EJ-300
EJ-410 / EJ-610

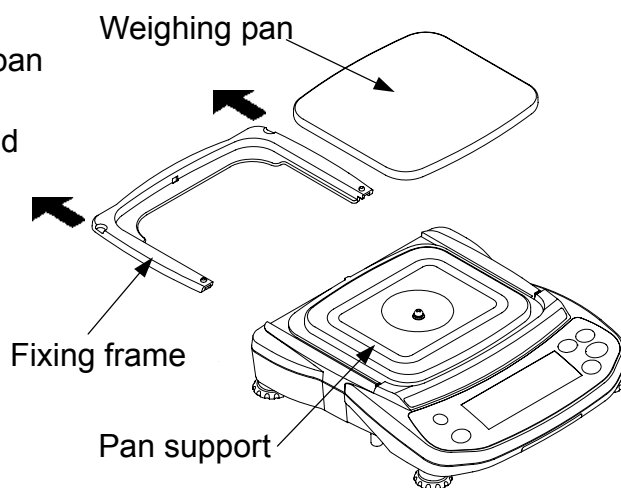

EJ-1500 / EJ-2000 / EJ-3000
EJ-4100 / EJ-6100

11-2. Error codes

Overload error

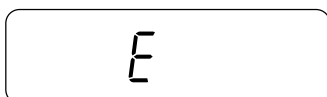

Warning to indicate that an object beyond the balance capacity has been placed on the pan. Remove the object from the pan.

Range over notice

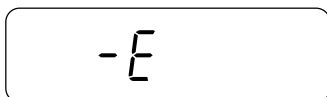

This will be shown if the weight sensor receives strong force upward. Check if there is anything sandwiched around the weighing pan. There is a possibility that the weight sensor itself may have a failure.

Unit weight error

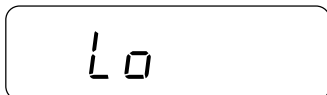

The sample weight is too light to set the unit weight in the counting mode or 100% reference weight in the % mode.

Sample quantity notice

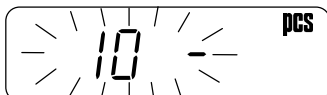

When sample weight is light and the counting error could become large, the balance will request you to use larger number of samples. Place the displayed number of samples on the pan and press the **PRINT** key to store

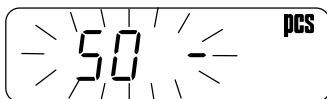

the unit weight.

Note: Pressing the **PRINT** key without adding samples may reduce counting accuracy.

Starting from the 100 samples, **100 -** may be displayed when the sample weight is light.

This is for your notice and press the **PRINT** key without adding any samples.

When “**ACR, 0**” (ACAI disabled) or “**U_n in 2**” is set, this notice is not shown.

CAL errors

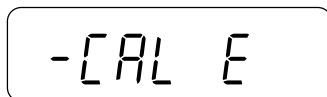
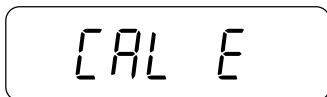

Warning to indicate that calibration has been canceled because the calibration weight is too heavy.

Warning to indicate that calibration has been canceled because the calibration weight is too light.

Check the weighing pan and the calibration weight.

To return to the weighing mode, press the **UNITS** key.

Battery error

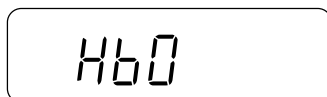
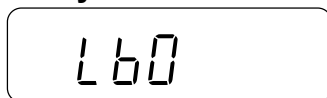

Warning to show that the batteries are exhausted. Replace them with new one or use the AC adapter.

Warning to show that the battery voltage is too high. Check the battery.

AC adapter error

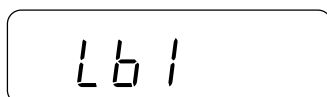
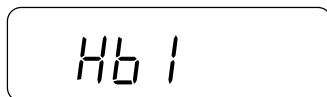

Warning to show that the output voltage of an AC adapter is too high. Check if the AC adapter is correct.

Warning to show that the output voltage of an AC adapter is too low. Check if the AC adapter is correct.

Stability error



Warning to indicate that the weight value is not stable and the balance cannot display it. Prevent vibration and drafts. Press the **UNITS** key to return to the weighing mode.

If you cannot cancel an error or other errors occurred, request service from the store where you purchased the balance or from your local A&D dealer.

12. SPECIFICATIONS

12-1. EJ series

MODEL	EJ-120	EJ-200	EJ-300	EJ-410	EJ-610
Weight capacity	120 g	210 g	310 g	410 g	610 g
Min. display "d"	0.01 g	0.01 g	0.01 g	0.01 g	0.01 g
Repeatability (Std. deviation)	0.01 g	0.01 g	0.01 g	0.01 g	0.01 g
Linearity	±0.01 g	±0.01 g	±0.02 g	±0.02 g	±0.02 g
Sensitivity drift	±20 ppm / °C (10°C~30°C / 50°F~86°F)				
No. of samples	5, 10, 25, 50 or 100 pieces				
Max. count *	12,000 pcs	21,000 pcs	31,000 pcs	41,000 pcs	61,000 pcs
Min. unit weight *	0.01 g				
Min. % display	0.1 %				
Min. 100 % weight	1 g				
Display	7 segment LCD display with backlight (Character height 16 mm)				
Display update	10 time per second				
Operating temp.	-10°C~40°C / 14°F~104°F, less than 85% R.H. (non-condensing)				
Power supply	AC adapter or 4 x "AA" size dry-cell batteries				
Battery operation	Approximately 70 hours (backlight off, alkaline batteries)				
Weighing pan size	110 mm ø				
Weight	Approximately 850 g				
Calibration weight (factory setting)	100 g	200 g	300 g	400 g	600 g

* In case of "Unit in g" (factory setting)

MODEL	EJ-1500	EJ-2000	EJ-3000	EJ-4100	EJ-6100
Weight capacity	1500 g	2100 g	3100 g	4100 g	6100 g
Min. display "d"	0.1 g	0.1 g	0.1 g	0.1 g	0.1 g
Repeatability (Std. deviation)	0.1 g	0.1 g	0.1 g	0.1 g	0.1 g
Linearity	±0.1 g	±0.1 g	±0.2 g	±0.2 g	±0.2 g
Sensitivity drift	±20 ppm / °C (10°C~30°C / 50°F~86°F)				
No. of samples	5, 10, 25, 50 or 100 pieces				
Max. count *	15,000 pcs	21,000 pcs	31,000 pcs	41,000 pcs	61,000 pcs
Min. unit weight *	0.1 g				
Min. % display	0.1 %				
Min. 100 % weight	10 g				
Display	7 segment LCD display with backlight (Character height 16 mm)				
Display update	10 time per second				
Operating temp.	-10°C~40°C / 14°F~104°F, less than 85% R.H. (non-condensing)				
Power supply	AC adapter or 4 x "AA" size dry-cell batteries				
Battery operation	Approximately 70 hours (backlight off, alkaline batteries)				
Weighing pan size	127 mm x 140 mm				
Weight	Approximately 970 g				
Calibration weight (factory setting)	1500 g	2000 g	3000 g	4000 g	6000 g

* In case of "Unit in g" (factory setting)

12-2. Other weighing units

MODEL		EJ-120	EJ-200	EJ-300	EJ-410	EJ-610
oz.	Capacity	4.233	7.408	10.935	14.462	21.517
	Min. display	0.001	0.001	0.001	0.001	0.001
lb	Capacity	0.2646	0.4630	0.6834	0.9039	1.3448
	Min. display	0.0001	0.0001	0.0001	0.0001	0.0001
ozt	Capacity	3.858	6.752	9.967	13.182	19.612
	Min. display	0.001	0.001	0.001	0.001	0.001
ct	Capacity	600.00	1050.00	1550.00	2050.00	3050.00
	Min. display	0.05	0.05	0.05	0.05	0.05
mom	Capacity	32.000	56.000	82.665	109.335	162.665
	Min. display	0.005	0.005	0.005	0.005	0.005
dwt	Capacity	77.16	135.03	199.33	263.64	392.24
	Min. display	0.01	0.01	0.01	0.01	0.01
GN	Capacity	1851.8	3240.8	4784.0	6327.2	9413.8
	Min. display	0.2	0.2	0.2	0.2	0.2
tola	Capacity	10.288	18.004	26.578	35.151	52.299
	Min. display	0.001	0.001	0.001	0.001	0.001
tl (HG)**	Capacity	3.1745	5.5555	8.2010	10.8465	16.1380
	Min. display	0.0005	0.0005	0.0005	0.0005	0.0005
tl (HJ)**	Capacity	3.2060	5.6105	8.2825	10.9540	16.2975
	Min. display	0.0005	0.0005	0.0005	0.0005	0.0005
tl (T)**	Capacity	3.2000	5.6000	8.2665	10.9335	16.2665
	Min. display	0.0005	0.0005	0.0005	0.0005	0.0005

MODEL		EJ-1500	EJ-2000	EJ-3000	EJ-4100	EJ-6100
oz.	Capacity	52.91	74.08	109.35	144.62	215.17
	Min. display	0.01	0.01	0.01	0.01	0.01
lb	Capacity	3.307	4.630	6.834	9.039	13.448
	Min. display	0.001	0.001	0.001	0.001	0.001
ozt	Capacity	48.23	67.52	99.67	131.82	196.12
	Min. display	0.01	0.01	0.01	0.01	0.01
mom	Capacity	400.00	560.00	826.65	1093.35	1626.65
	Min. display	0.05	0.05	0.05	0.05	0.05
dwt	Capacity	964.5	1350.3	1993.3	2636.4	3922.4
	Min. display	0.1	0.1	0.1	0.1	0.1
GN	Capacity	23148	32408	47840	63272	94138
	Min. display	2	2	2	2	2
tola**	Capacity	128.60	180.04	265.78	351.51	522.99
	Min. display	0.01	0.01	0.01	0.01	0.01
tl (HG)**	Capacity	39.685	55.555	82.010	108.465	161.380
	Min. display	0.005	0.005	0.005	0.005	0.005
tl (HJ)**	Capacity	40.075	56.105	82.825	109.540	162.975
	Min. display	0.005	0.005	0.005	0.005	0.005
tl (T)**	Capacity	40.000	56.000	82.665	109.335	162.665
	Min. display	0.001	0.005	0.005	0.005	0.005

****The unit "tola" and three kinds of "tl" are for special versions only and one of them will be available.**

tl (HG): Hong Kong General / Singapore tael

tl (HJ): Hong Kong Jewelry tael

tl (T): Taiwan tael

12-3. Options

EJ-02	USB interface
EJ-03	RS-232C interface
EJ-07	Underhook for EJ-3000 / EJ-4100 / EJ-6100
EJ-08	Underhook for EJ-1500 / EJ-2000
EJ-11	Breeze break
EJ-12	Carrying case
EJ-13	Density Determination Kit for EJ-120 / EJ-200 / EJ-300 / EJ-410 / EJ-610

12-4. Dimensions

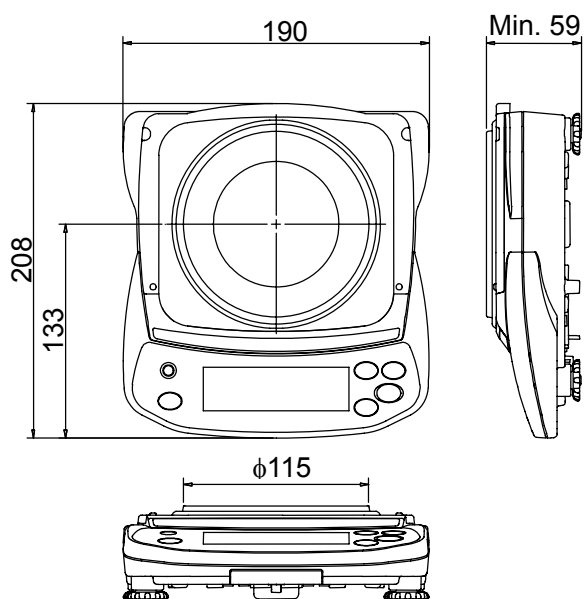

EJ-120 / EJ-200 / EJ-300
EJ-410 / EJ-610

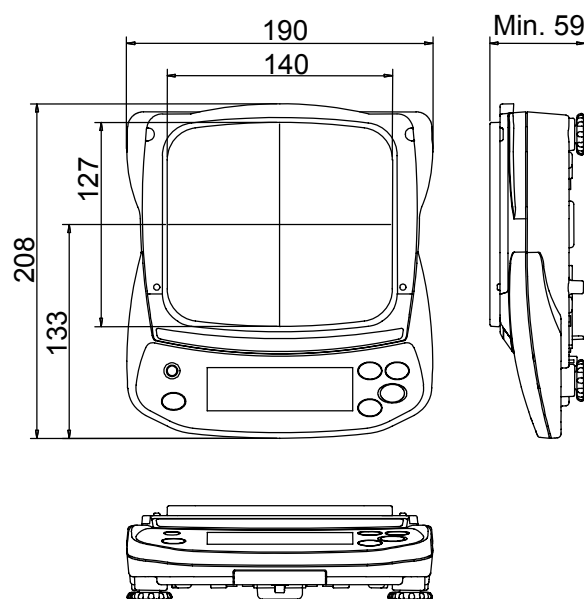

EJ-1500 / EJ-2000 / EJ-3000
EJ-4100 / EJ-6100

Unit: mm

GRAVITY ACCELERATION MAP

Values of gravity at various locations

Amsterdam	9.813 m/s ²	Manila	9.784 m/s ²
Athens	9.807 m/s ²	Melbourne	9.800 m/s ²
Auckland NZ	9.799 m/s ²	Mexico City	9.779 m/s ²
Bangkok	9.783 m/s ²	Milan	9.806 m/s ²
Birmingham	9.813 m/s ²	New York	9.802 m/s ²
Brussels	9.811 m/s ²	Oslo	9.819 m/s ²
Buenos Aires	9.797 m/s ²	Ottawa	9.806 m/s ²
Calcutta	9.788 m/s ²	Paris	9.809 m/s ²
Cape Town	9.796 m/s ²	Rio de Janeiro	9.788 m/s ²
Chicago	9.803 m/s ²	Rome	9.803 m/s ²
Copenhagen	9.815 m/s ²	San Francisco	9.800 m/s ²
Cyprus	9.797 m/s ²	Singapore	9.781 m/s ²
Djakarta	9.781 m/s ²	Stockholm	9.818 m/s ²
Frankfurt	9.810 m/s ²	Sydney	9.797 m/s ²
Glasgow	9.816 m/s ²	Taichung	9.789 m/s ²
Havana	9.788 m/s ²	Taiwan	9.788 m/s ²
Helsinki	9.819 m/s ²	Taipei	9.790 m/s ²
Kuwait	9.793 m/s ²	Tokyo	9.798 m/s ²
Lisbon	9.801 m/s ²	Vancouver, BC	9.809 m/s ²
London (Greenwich)	9.812 m/s ²	Washington DC	9.801 m/s ²
Los Angeles	9.796 m/s ²	Wellington NZ	9.803 m/s ²
Madrid	9.800 m/s ²	Zurich	9.807 m/s ²

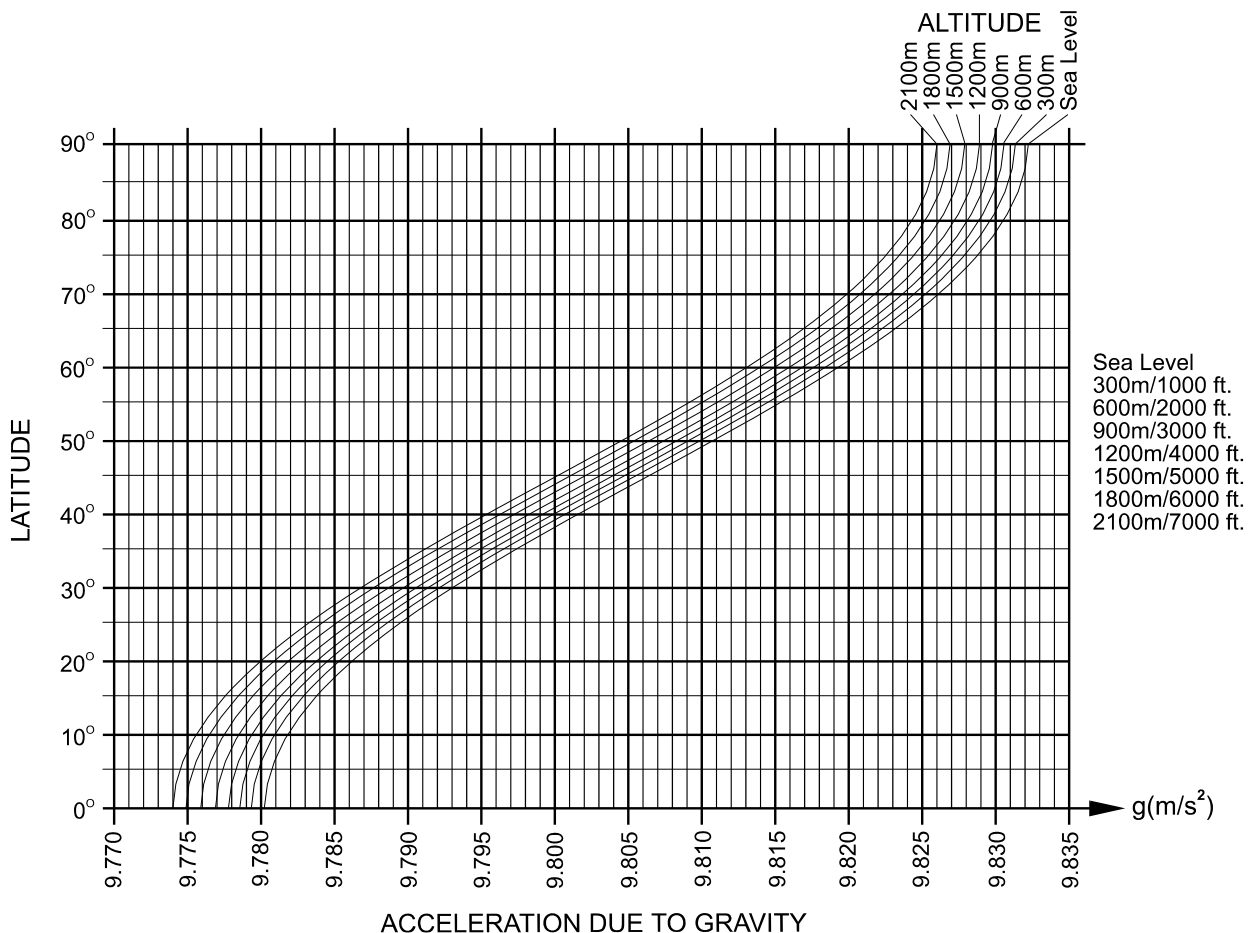

World map

