

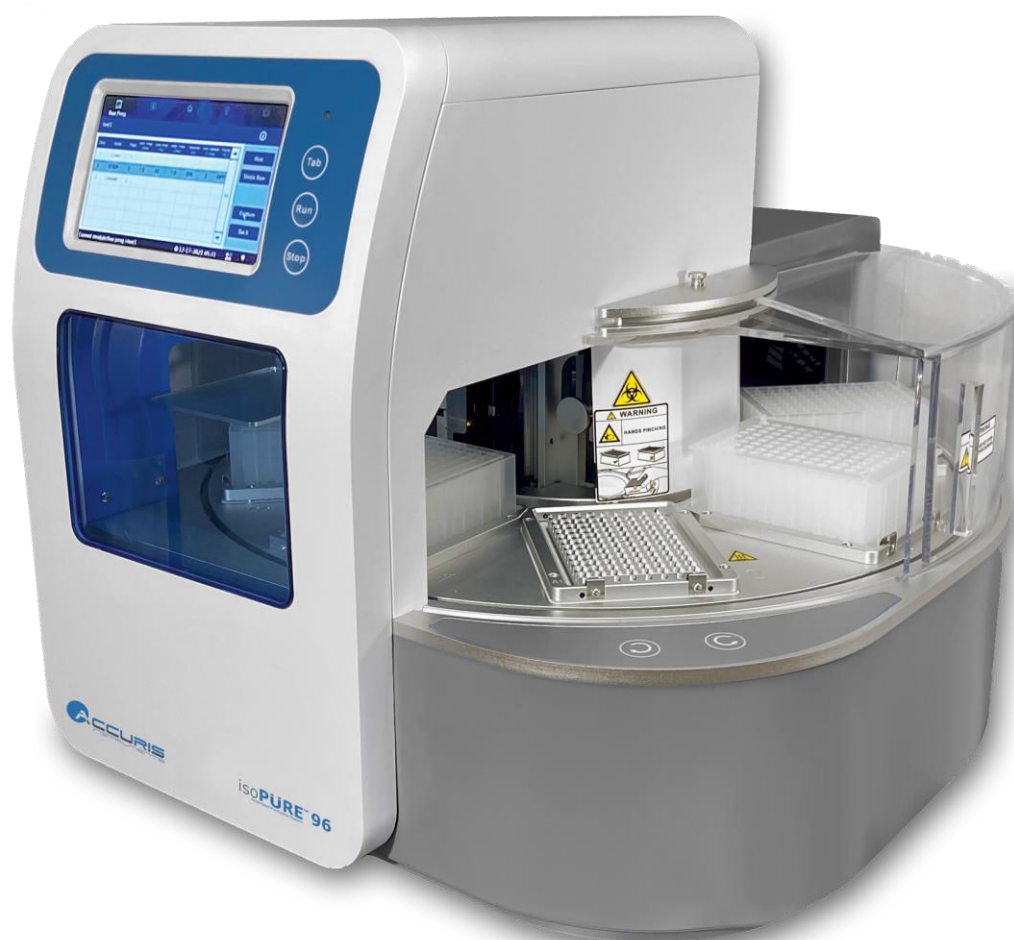
# Operation Manual

## V1.0

# isoPURE™ 96

Automated Purification System

## AP1096





Thank you for purchasing the IsoPure™ 96 Automated Purification System. This user manual details the instrument's features, specifications, as well as complete operating instructions; please read it carefully before operation. Keep this user manual for later use.

**Important:**

**Please keep the box and packaging material for this instrument. If service is required, the box will be needed to ship the instrument to our Service Department.**

**Initial Inspection**

Please inspect the instrument as well as all included accessories when you first open the packaging. If you find anything damaged or missing, please contact Benchmark Scientific or your local distributor immediately.

**BENCHMARK SCIENTIFIC / ACCURIS INSTRUMENTS**

PO Box 709

Edison, NJ 08818

USA

Phone: 908-769-5555

Website: [www.benchmarkscientific.com](http://www.benchmarkscientific.com) / [www accuris-usa.com](http://www accuris-usa.com)

Email: [info@benchmarkscientific.com](mailto:info@benchmarkscientific.com) / [info@accuris-usa.com](mailto:info@accuris-usa.com)

# Safety Warnings and Guidelines

## 1. Important information for safe use

Users should understand how to use this instrument before operating. Please read this manual carefully prior to operation.



Any improper operation may cause injury. Please read this manual carefully and operate safely according to the guidelines.

## 2. Operation and Maintenance

The operation and maintenance of the instrument should comply with the basic guidelines and warnings below. Incorrect operation or maintenance will have detrimental effects on the life, performance, and safety features of the instrument.



The instrument is a normal indoor instrument which conforms to class I of the GB 4793.1 standard.



This instrument is designed for use in a laboratory environment. The device must be operated by skilled laboratory personnel with appropriate training.



To prevent injury or voiding the warranty, the operator should not attempt to repair the instrument without explicit guidance from Accuris Instruments. If service is required, please contact Accuris Instruments or your local distributor for repair.



Before powering on, confirm that the voltage used meets the electrical requirements of the instrument as stated on the rating plate. If the electric cord is damaged, replace it with the same type of cord. Hold the socket firmly before pulling the plug from an outlet. Do not pull the electric cord.



The temperature of the heating block can be high; please do not touch it while it is in use to prevent injury.



The instrument should be installed in an environment of standard room temperature, low dust, low humidity, and away from direct sunlight, electromagnetic interference, and heat sources. Do not block the vents on the instrument.



Always power off the instrument when you are finished using it. Unplug the power cord and cover the instrument with a cloth or plastic sheet to prevent excessive dust from entering the housing.



Pull the connector plug from the electrical outlet immediately and contact the vendor in the event of:

- Liquid entering the housing.
- Abnormal operation: such as any abnormal sound or smell.
- The instrument is dropped or there is any damage to the housing.
- Any malfunction.

### **3. Maintenance**

The instrument should be cleaned regularly using a soft cloth dampened with a small amount of alcohol.

### **4. Transportation and storage requirements**

Ambient temperature: 10°C ~ 35°C

Relative humidity: ≤ 70%

Atmosphere pressure range: 500 ~ 1060hpa

Place in a well-ventilated room, away from corrosive gas.

# Table of Contents

<b>Chapter 1 Introduction</b> .....	1
1. Key Features.....	1
<b>Chapter 2 Specifications</b> .....	2
1. Required Installation Environment.....	2
2. Specifications .....	2
<b>Chapter 3 Instrument Overview</b> .....	3
1. Structure.....	3
2. Control Panel .....	4
<b>Chapter 4 Instrument Setup</b> .....	5
1. Preparation Before Use .....	5
2. Plate & Tip Comb Installation.....	6
<b>Chapter 5 Programming &amp; Operation</b> .....	7
1. Instrument Startup .....	7
2. Run Protocol Interface .....	7
3. Manage Protocol Interface.....	10
4. Settings Interface .....	14
5. UV Sterilization Interface .....	16
6. Help Interface.....	16
<b>Chapter 6 Troubleshooting</b> .....	17

# Chapter 1 Introduction

The IsoPure™ 96 is an automated purification system for DNA/RNA, proteins, and cells. It can bind, transfer and release magnetic beads by using moveable magnetic rods. Users can extract 1~96 samples simultaneously with appropriate magnetic bead kits and reagents available from many suppliers. The IsoPure™ series can be used with samples from animal/plant tissue, blood, and body fluids.

## 1. Key Features

- User-Friendly Input & Operation - Touch screen, 3 operation shortcut keys, included mouse.
- High Throughput – Process up to 96 samples at a time
- Internal LED Lighting for visualization
- Open software system – Editable protocols with storage for up to 100 protocols.
- Heating function – 2 heating blocks with adjustable heating parameters.
- UV Sterilization function (3W UVC bulb) to reduce risk of cross-contamination.
- Safe and reliable - Fully automated with disposable consumables.
- Fast extraction - 10 ~ 60min depending on protocol & optimization.

# Chapter 2 Specifications

## 1. Required Installation Environment:

Environmental Temperature: 10°C~35°C

Relative Humidity: ≤ 70%

Input Voltage: AC 100~240V, 50Hz/60Hz

## 2. Specifications

<b>Model</b>	<b>IsoPure™ 96</b>
<b>Display</b>	7.0-inch touch screen
<b>Purification Method</b>	Magnetic Bead-Based Purification
<b>Sample volume</b>	50μL – 1000μL
<b>Throughput</b>	Up to 96 samples using deep-well plates
<b>Stability</b>	CV ≤ 5%
<b>Extraction Time</b>	10 ~ 60 minutes
<b>Lysis &amp; Elution Temperature</b>	Ambient +5°C – 120°C
<b>Temperature Accuracy</b>	± 1°C
<b>Programming Control</b>	Touch screen to create and edit protocols
<b>Program Storage</b>	Store up to 100 programs in internal memory
<b>Communication Ports</b>	USB for mouse, flash drive, and PC connection
<b>Data Transfer</b>	USB flash drive
<b>Consumables</b>	Standard 96 deep well plates & tip combs
<b>UV Sterilization</b>	UV Lamp (3W UVC, 253.7 λ)
<b>Magnetic Bead Recovery</b>	> 95%
<b>Internal Lighting</b>	LED lamp
<b>Dimensions</b>	55 cm x 62cm x 48cm / 21.7in x 24.4in x 18.9in
<b>Weight</b>	54 kg / 119 lbs



# Chapter 3 Instrument Overview

## 1. Structure

### Front

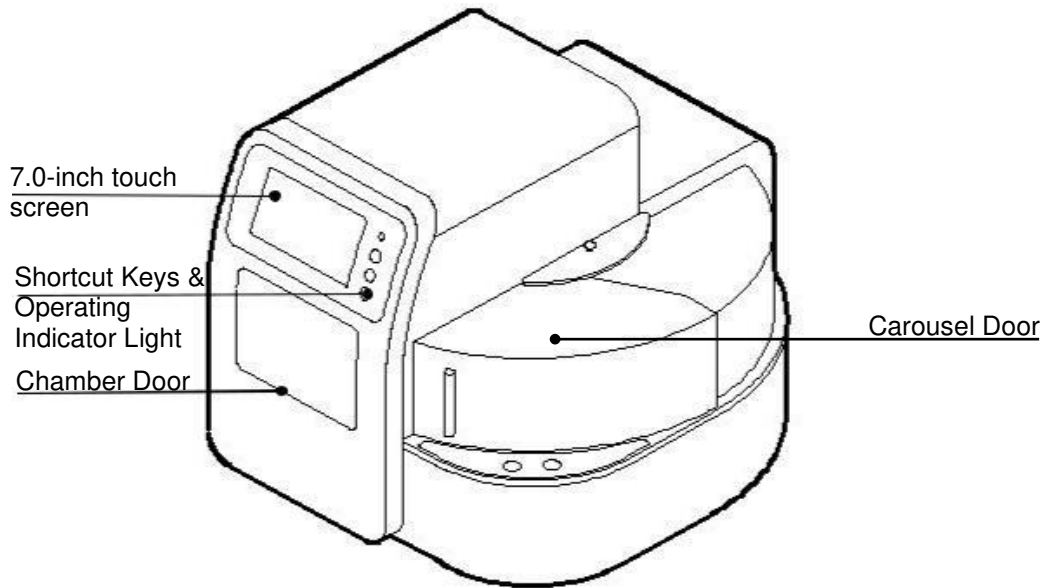


Fig. 1 Front

### Back

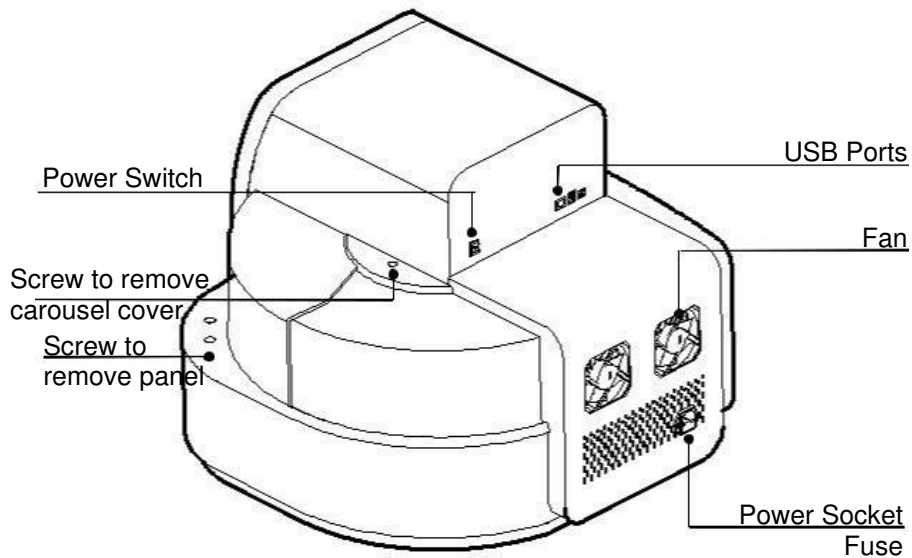


Fig. 2 Back

Side

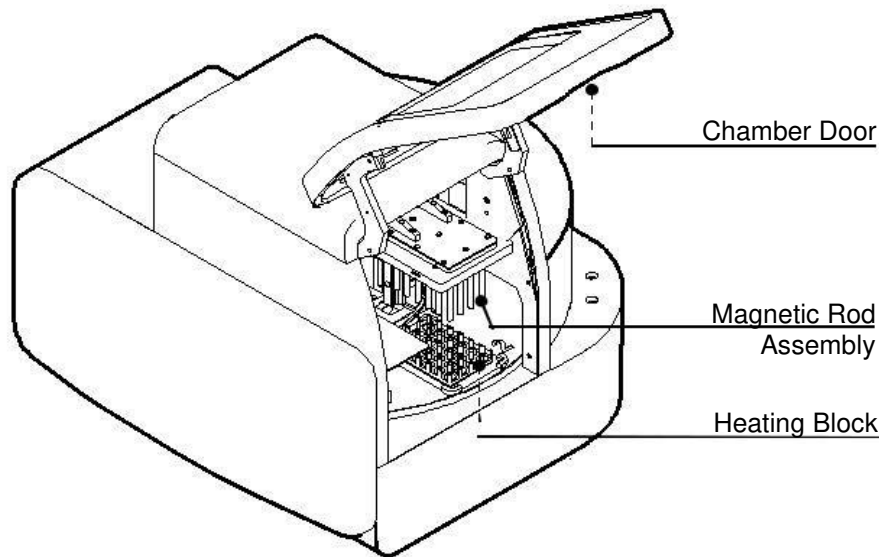


Fig. 3 Side

## 2. Control Panel

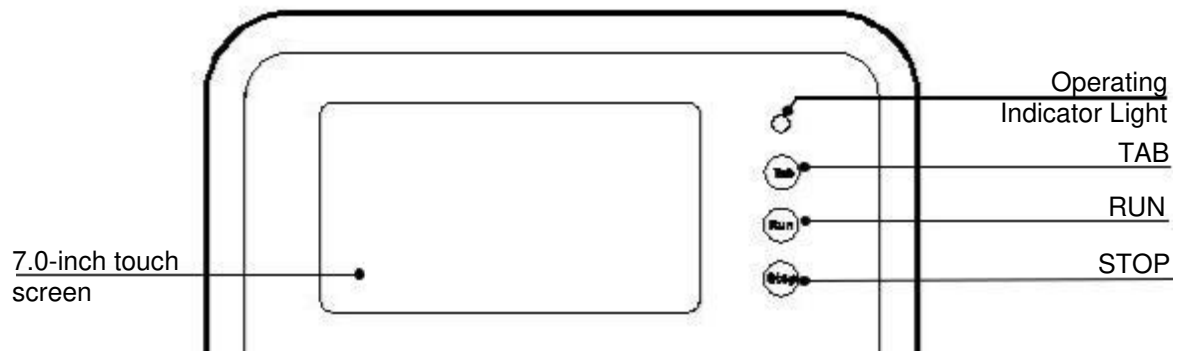


Fig. 4 Control Panel

**Touch screen:** For programming and operation (mouse also can be connected for operational control).

**TAB:** Switch between protocols.

**RUN:** Start the protocol.

**STOP:** Stop the operation

# Chapter 4 Instrument Setup

## 1. Preparation Before Use

### Remove transport packaging

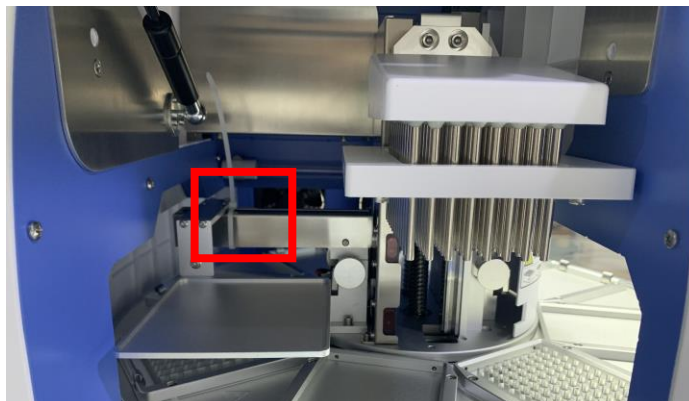
Carefully take the instrument out of the shipping carton and remove the tape from the carousel door.



Open the carousel door and remove the red retaining screw.



Open the chamber door and use scissors to cut the zip tie.

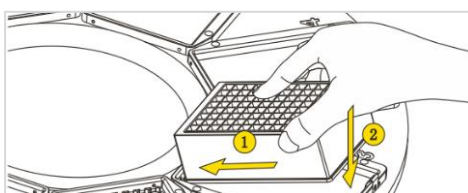


**Note: Remove the packing materials with caution. Use caution to not bend or damage the magnetic rods.**

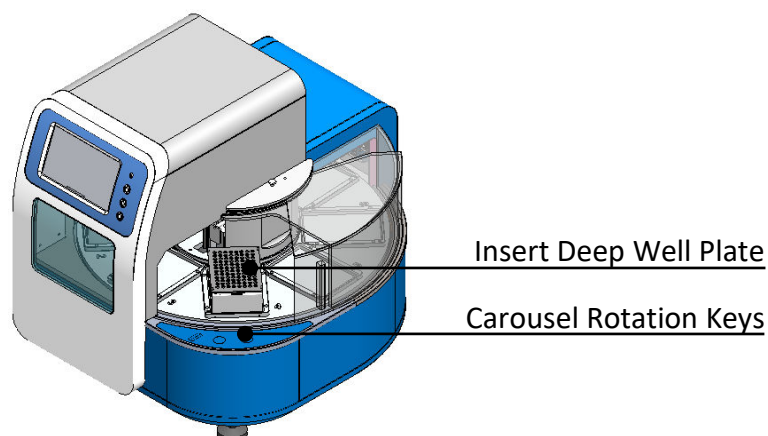
**Connect the power using the included power cord** (acceptable input voltage: AC100-240V). Power the instrument on with the power switch.

## 2. Plate & Tip Comb Installation

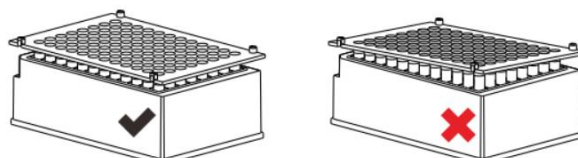
Open the carousel door and use the carousel rotation keys to move the carousel so plates can be inserted into their correct positions. Insert plates into their positions on the carousel and make sure they are properly seated. Insert the plates at an angle so the leading edge fits into position first, then press down so the plate is flat and fully locked into place. Incorrect plate insertion will cause a malfunction.



Tip combs are placed into an empty plate, and the “Load” step of a protocol is set to pick up the combs from this position. The instrument will automatically pick up the tip combs from the set plate position when a protocol starts.



**Note: The tip combs must be properly into of the 96 deep well plate so they sit flat or it may damage the instrument.**



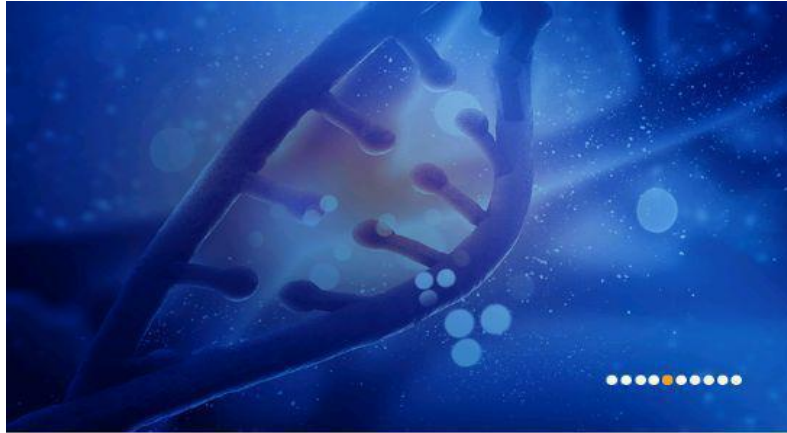
It is recommended to use 96 Deep Well Plates and Tip Combs, available from Accuris Instruments.

Catalog No.	Description
AP1096-DWP	96 Deep Well Plates for IsoPure™ 96
AP1096-TC	Tip Combs for IsoPure™96

# Chapter 5 Programming & Operation

## 1. Instrument Startup

Before powering on the IsoPure™ 96, make sure the chamber and carousel door are closed. The following screen image will appear during the start-up.



**Fig. 5 Startup Interface**

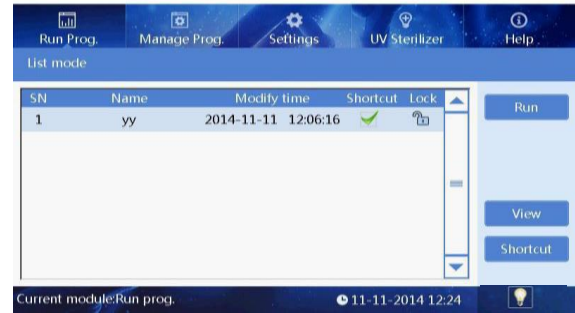
After start-up, the instrument will enter the “Run Prog.” interface.

## 2. Run Protocol Interface

This interface is divided into two modes: **Shortcut Mode** and **List Mode**.



**Fig. 6 Shortcut Mode**



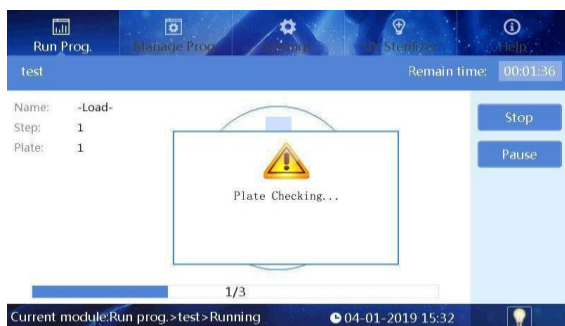
**Fig. 7 List Mode**

Highlighting a protocol from the list and pressing the “Shortcut” button will add the program to the “Shortcut” page. Up to 8 protocols can be selected at once.

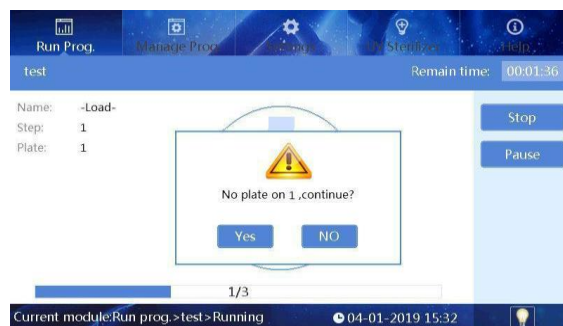
“SN” (Script Number), “Name”, “Date Modified”, “Shortcut”, and “Lock” are non-editable options in this interface.

## Running a protocol

In either **Shortcut Mode** or **List Mode**, highlight a protocol and press “Run” to start it. The instrument will perform a self-check to ensure all plate positions that require plates are filled (**Fig. 8**). If no plate is found on its respective position on the carousel, the program will prompt to confirm whether the following steps can continue (**Fig. 9**)

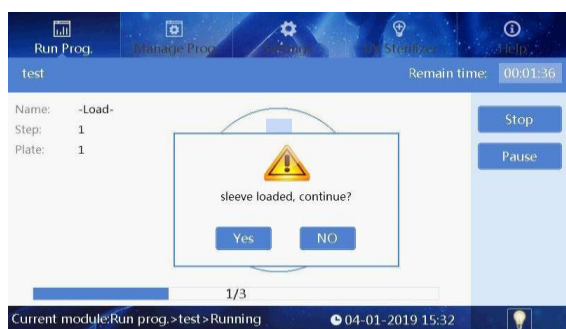


**Fig. 8 Instrument Self-Check**

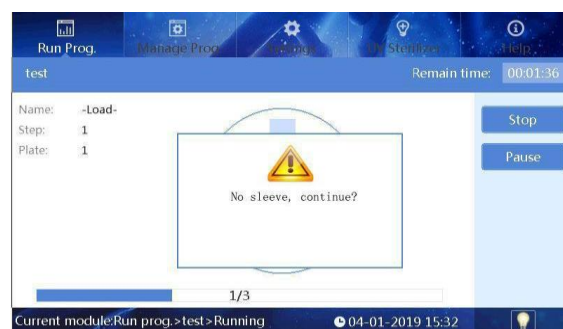


**Fig. 9 No Plate Detected**

After performing a self-check, the instrument will automatically load the tip combs onto the tip comb holder. If the tip combs have already been loaded, the "Tip combs preloaded, continue?" prompt will display (**Fig. 10**). If no tip comb is detected after attempting to load the tip comb, "No tip comb detected, continue?" will appear (**Fig. 11**).



**Fig. 10 Tip Comb Loaded Prior to Run**



**Fig. 11 No Tip Comb Detected**

After the tip comb installation, the protocol will begin (**Fig. 12**).



**Fig. 12 Protocol Start**

While a protocol is running, the “Stop” button can be used to end the run, or the “Pause” button can be used to pause the run at its current step. The graphic display of the carousel and plates (**Fig. 12**) indicates the current plate in use, highlighted in blue. The red corner marks on plate 1 indicate that the instrument is currently using the plate or has already finished using the plate. The blue corner mark on plate 2 indicates the plate position of the next step. One corner mark indicates that the protocol involves a plate for only one step. Two corner marks indicate that the protocol involves a plate for two different steps.

After the completion of a protocol, the No. 8 plate position will automatically be moved to the carousel cover door for easy access and removal of eluted samples.


### Preview Protocols

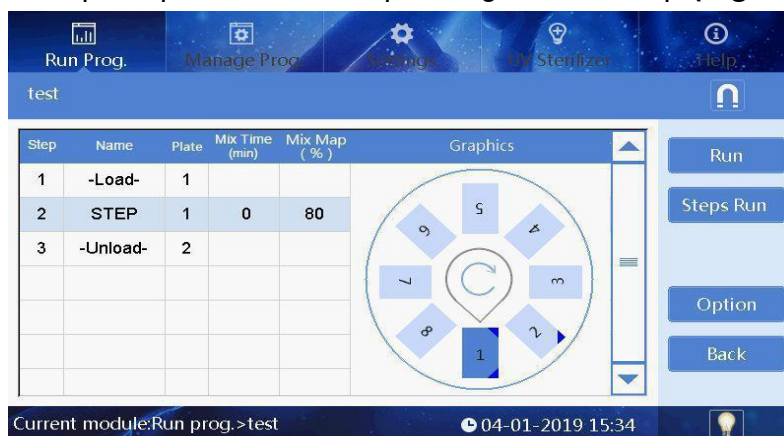
In the **List View** or **Shortcut View**, select a protocol and press the “View” button to view the steps/parameters of the protocol (**Fig. 13**).



Step	Name	Plate	Mix Time (min)	Mix Map (%)	Wait Time (min)	Volume (µl)	Mix Speed (1-10)	Temp (°C)
1	-Load-	1						
2	STEP	3	1.5	80	1.0	200	5	OFF
3	STEP	5	0	80	1.0	200	5	OFF
4	-Unload-	2						


**Fig. 13 View Protocol Steps/Parameters**

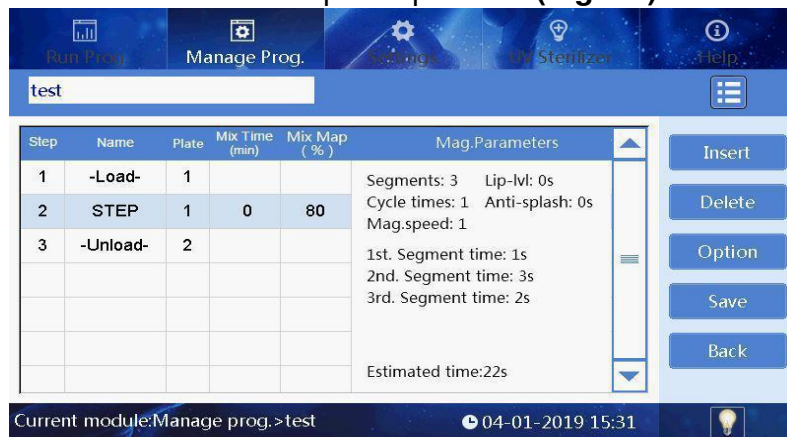
Press the  icon in the upper right corner to switch to the graphic display. This display highlights the plate positions corresponding to each step (**Fig. 14**).



Step	Name	Plate	Mix Time (min)	Mix Map (%)	Graphics
1	-Load-	1			
2	STEP	1	0	80	
3	-Unload-	2			

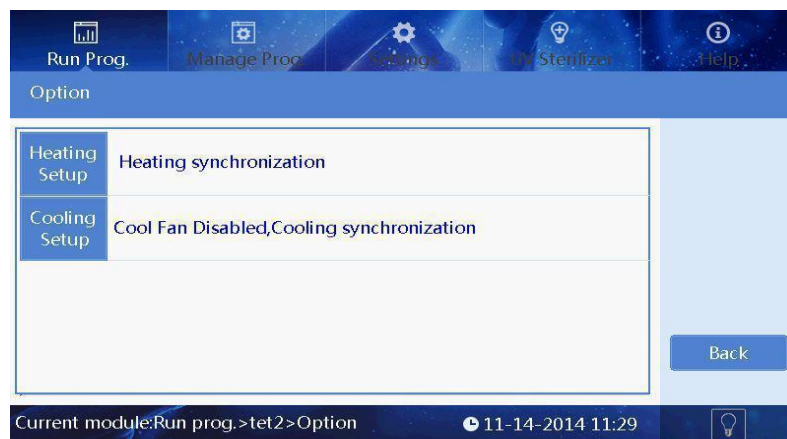
**Fig. 14 Graphic Display**

Press the  icon to view the magnetization parameters. This display highlights magnetization parameters for each step of a protocol (**Fig. 15**).



**Fig. 15 Magnetization Parameters**

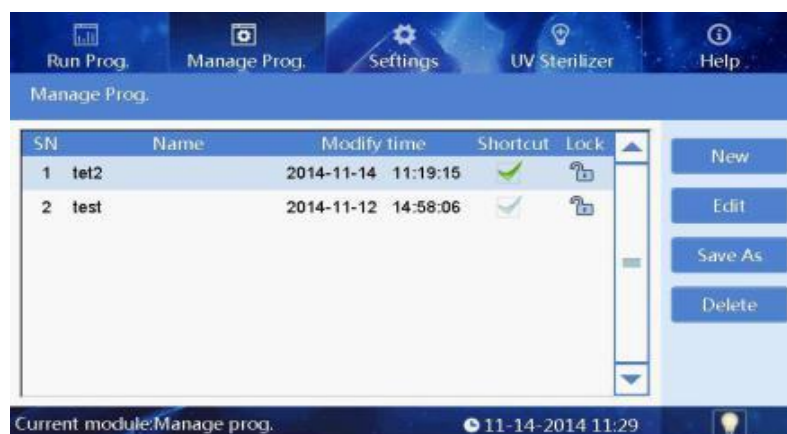
Click on the “Option” button (**Fig. 16**). This interface allows for the adjustment of heating and cooling parameters.



**Fig. 16 Option Settings**

### 3. Manage Protocol Interface

Users can manage all protocols in the “Manage Prot.” interface. This interface allows for locking and unlocking protocols. Click the lock icon to lock and unlock protocols. Protocols cannot be edited, saved, or deleted if locked.



**Fig. 17 Manage Protocol Interface**



## New/Edit Interface

Click the “New” button in the “Manage Prot.” interface to create a new protocol. Click the “Edit” button to edit any step of the currently highlighted protocol.

Both the “New” and “Edit” interfaces will display 5 buttons: “Insert”, “Delete”, “Option”, “Save” and “Back”.

**Insert:** Add a new step with default parameters below the currently highlighted step (**Fig. 18**).

**Delete:** Delete the selected step.

**Option:** Configure advanced settings for heating and cooling

**Save:** Save the program file. A valid program name is necessary.



**Fig. 18 Insert a New Step**



**Fig. 19 Set Step Parameters**

When programming each step, the following parameters can be set:

**Name:** Set a name for the step

**Plate:** Select plate position for the selected step

**Mix time:** The mixing time for selected plate (also considered “Dry Time”)

**Mix Amp:** Mixing amplitude 1 to 100%. The mixing amplitude is calculated in relation to the volume entered

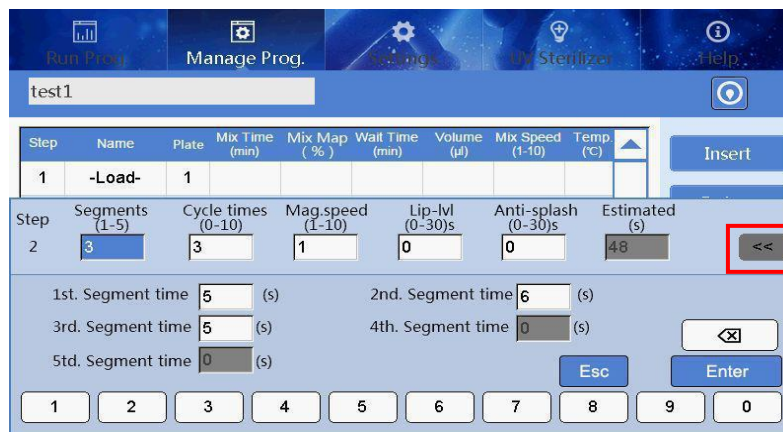
**Wait time:** Wait time before next step (also considered “dry time”: beads are held above the sample plate.

**Volume:** Enter the volume of sample liquid.

**Mix speed:** Mixing speed of magnetic tip combs. 10 levels (1-10). The higher the value is, the faster the mixing speed will be.

**Temp.:** Set the temperature of the heating blocks (only plate position 2 and 8).

Click the “ >> ” icon on the right side while a step is highlighted to enter the magnetization parameters (**Fig. 20**).



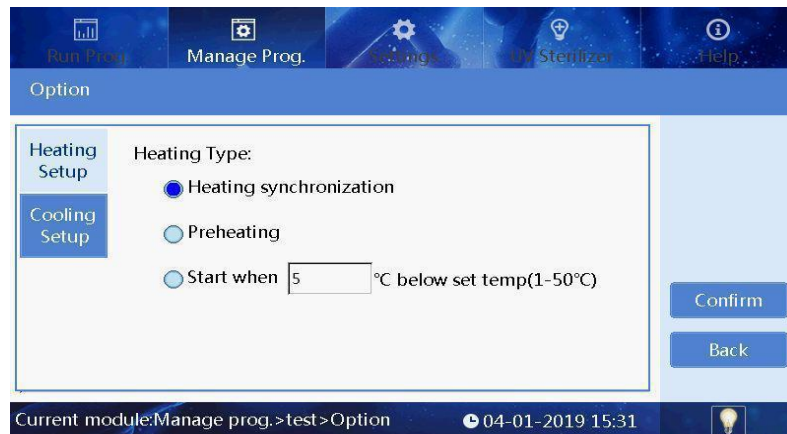
**Fig. 20 Enter Magnetization Parameter Settings**

### Magnetization Parameters:

- **Segments:** To maximize the collection of magnetic beads after mixing, up to 5 vertical segment positions can be selected. If “Segments” is set to 0, the other magnetization settings cannot be adjusted.
- **Segment time:** Independent magnetic binding time of each segment position.
- **Cycle times:** Repeat the full cycle of the set segments’ parameters up to 10 times.
- **Mag.speed:** Speed of magnetic rod & comb movement when the magnetic rod is under the liquid level. 1 is the slowest while 10 the fastest.
- **Lip-lvl:** The pause time when magnetic rods are close to liquid surface level (after bead collection) to prevent loss of beads due to breaking the surface tension.
- **Anti-splash:** The pause time after magnetic rods have moved above the liquid surface level (after having collected the magnetic beads) to prevent drip cross contamination of samples.
- **Estimated:** The estimated total time for the magnetic binding process can be viewed when setting protocol parameters.

## Options Setting

In the New/Edit interface, click “Option” to enter the option interface (**Fig. 21**). This interface allows for setting heating and cooling parameters to optimize the purification process. The set parameters in the option interface are applied to the whole program.



**Fig. 21 Option Interface**

**Confirm:** Save all settings and exit.

**Back:** Return to previous tab without saving.

### Heating Setup:

- **Heating synchronization:** Heating starts, and tip comb movement are carried out synchronously
- **Preheating:** When the protocol reaches a step that requires heating, the heating block will start to heat to the required temperature first, then the tip comb movement will begin only after the set temperature is reached.
- **Start when:** Tip comb movement is carried out when the temperature is close to the set temperature.

### Cooling Setup:

- **Cooling synchronization:** Cooling starts, and tip comb movement are carried out synchronously
- **Precooling:** When the protocol reaches a step that requires cooling, the heating block will start to cool to the required temperature first, then the tip comb movement will begin only after the set temperature is reached.
- **Start when:** Tip comb movement is carried out when the temperature is close to the set temperature.

## 4. Settings Interface

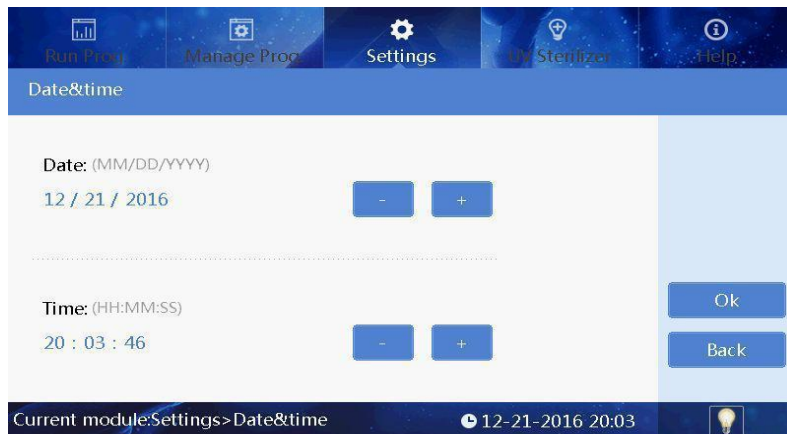
In the “Settings” interface, the following options can be selected: “Instrument”, “Date & time”, “Language”, “Ventilation”, “Im.&export” and “Upgrade”.



**Fig. 22 Settings Interface**

### System Time

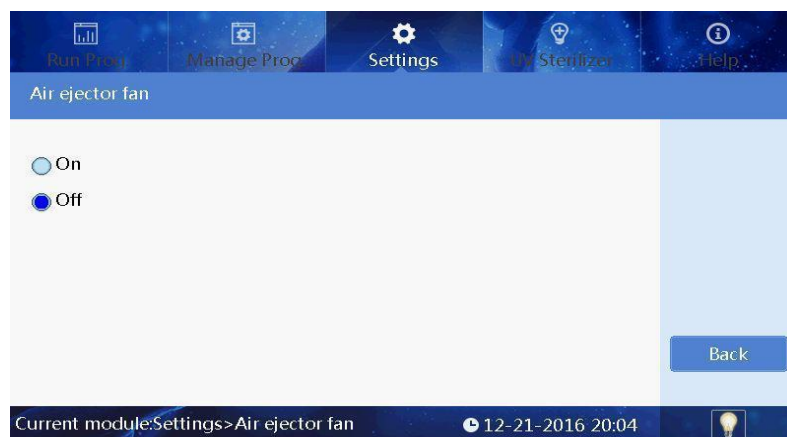
Select the “Date & time” icon to update the date and time, as shown in Figure 26. The date and time can be adjusted using the “+” or “-” input.



**Fig. 23 Date&Time Interface**

### Ventilation Fan:

Choose “On” or “Off” to turn on/off ventilation of the instrument.



**Fig. 24 Ventilation Fan Interface**

## Import and Export

To import/export a protocol, insert the included USB flash drive into the IsoPure™ 96. If importing a protocol, the file must be saved in the USB drive under a folder labeled “items”. Then, select the “Import ” (or “Export”) button to enter the flash drive directory. Select the required protocols for transfer and press “Ok” to import/export.

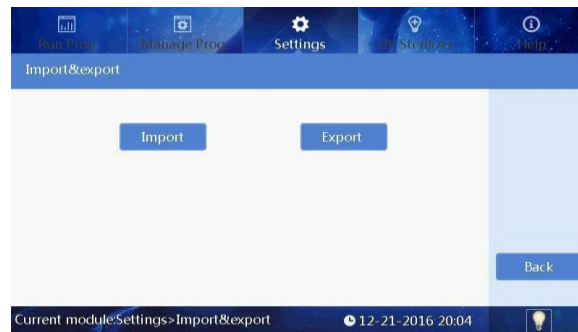


Fig. 25 Import & Export Interface

## Software Upgrade

To update the software of the IsoPure™ 96, insert a USB flash drive with the latest software into the instrument, and select either the “Interface Update” or “Control Update” icon. Contact Accuris Instruments or your local distributor for the latest available software.

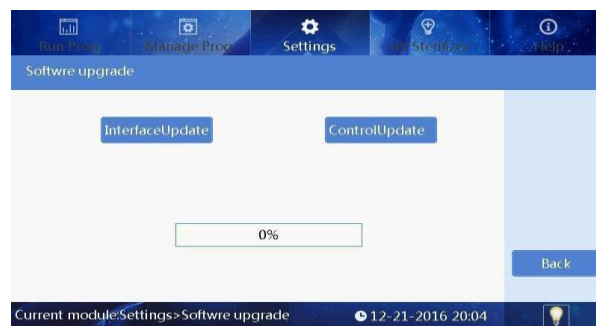


Fig. 26 Upgrade Interface

## Log Interface

Each program run of the instrument is automatically logged into a running record. Users can check the records by selecting the “Search” button (Fig. 27). Choose a range of dates to view a specific range of records. To export a log, select a program file, and select the “Export” button (Fig. 27).

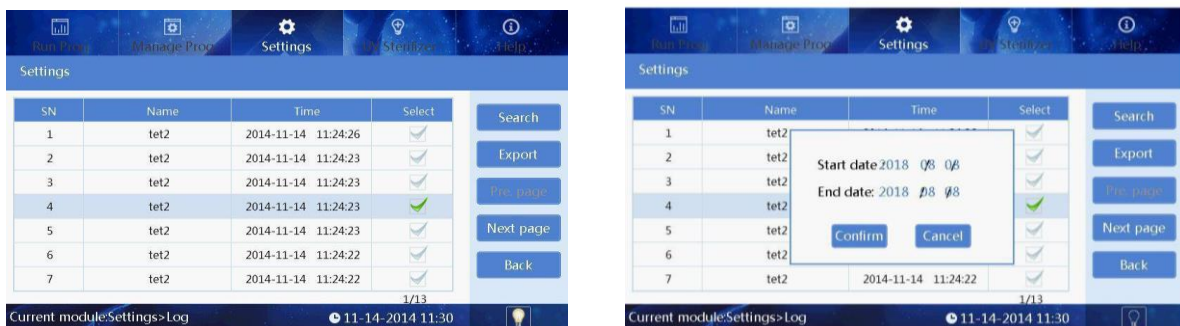




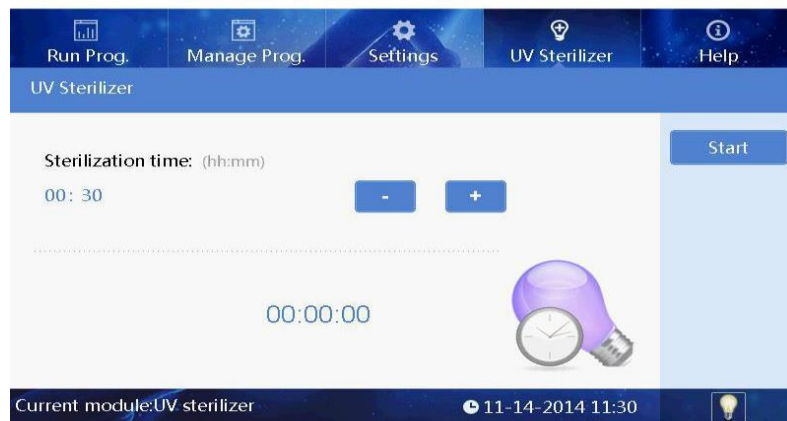
Fig. 27 Instrument Log Interface

## Internal Lighting

The lightbulb icon at the bottom right of the display can be selected to turn on the internal lighting. When the icon shows a white bulb “”, the lighting is turned on. When the icon displays a dark bulb “”, the lighting is turned off.

## 5. UV Sterilization Interface

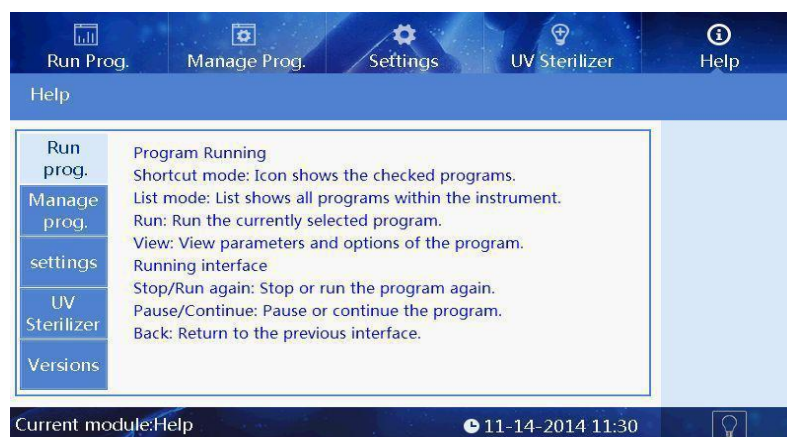
The IsoPure™ 96 includes a UV lamp for sterilizing the sample processing chamber to prevent cross contamination between program runs. The UV sterilization interface is used for turning the UV lamp on and off. The time can be adjusted by pressing “+” or “-” button (**Fig. 28**). It is recommended to perform UV sterilization for 30 minutes after operation.



**Fig. 28 UV Sterilization Interface**

## 6. Help Interface

The help interface provides information about different settings and the current software version (**Fig. 29**)



**Fig. 29 Help Interface**

## Chapter 5 Troubleshooting

No.	Trouble	Analysis	Troubleshooting
1	<b>No display after turning the instrument on</b>	Power not connected	Check power
		Switch failure	Replace switch
		Fuse failure	Replace fuse (5X20 250V 8A)
		Other	Contact Accuris Instruments
2	<b>No UV light</b>	UV bulb failure	Replace UV bulb Contact Accuris
3	<b>No internal light</b>	LED Light failure	Replace LED Contact Accuris
4	<b>Program does not stop automatically after opening the door.</b>	Sensor failure	Contact Accuris Instruments
5	<b>Noticeable difference between the actual and display temperature</b>	Sensor failure	Contact Accuris Instruments
6	<b>Heating strips not heating properly</b>	Sensor failure	Contact Accuris Instruments
		Heater failure	
7	<b>Instrument does not start protocols after pressing “run”</b>	Controller failure	Contact Accuris Instruments
		Motor failure	
8	<b>Abnormal sound during operation</b>	Guide rail installed incorrectly	Contact Accuris Instruments
		Motor failure	
		Synchronous belt is worn/damaged	
9	<b>“Tab”, “Run”, and/or “Stop” buttons not working as intended</b>	Switch button failure	Contact Accuris Instruments

## Software Error Codes

<b>Fault type</b>	<b>Fault name</b>	<b>Error</b>
<b>Temperature (code: 0)</b>	<b>T1 Overheat</b>	<b>E011</b>
	<b>T1 Open circuit</b>	<b>E015</b>
	<b>T1 Short circuit</b>	<b>E016</b>
<b>Sensor Errors (code:4)</b>	<b>Baffle motor sensor</b>	<b>E404</b>
	<b>Rotary motor sensor damaged</b>	<b>E405</b>
	<b>Lifting platform motor sensor damaged</b>	<b>E406</b>
	<b>Push rod motor sensor damaged</b>	<b>E407</b>
	<b>Motor position sensor of magnetic tip comb damaged</b>	<b>E425</b>
	<b>Magnetic rod motor position sensor damaged</b>	<b>E415</b>
<b>LCD, Crystal oscillator, Storage (code: 7)</b>	<b>The clock crystal is damaged</b>	<b>E702</b>
	<b>Memory chip E2P damaged Setting parameters lost</b>	<b>E703</b>
	<b>New instrument, instrument type hasn't been set</b>	
	<b>The instrument's zero calibration is not in the correct position</b>	
<b>Communication (code: 8)</b>	<b>Moving parts online failure</b>	<b>E801</b>
	<b>Rotary parts online failure</b>	<b>E802</b>