

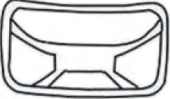











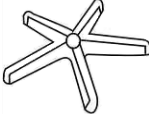

## PARTS LIST

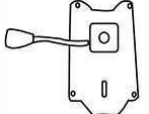
**ATTENTION:** Before you begin the assembly, make sure that all parts are included in good condition.

<b>A</b> Backrest, x1 	<b>G</b> Backrest Support, x1 	<b>4</b> Screw Knob x1 
<b>B</b> Seat, x1 	<b>H</b> Covers for Gas Lift, x1 set 	<b>5</b> 8x20mm x1 
<b>C</b> Star Base, x1 	<b>1</b> 6x16mm, x4 	<b>6</b> Allen wrench, x1 
<b>D</b> Mechanism, x1 	<b>2</b> 6x25mm, x2 	
<b>E</b> Hydraulic Gas Lift, x1 	<b>3</b> Back cover, x1 SET 3A: Plastic cover  3B: Metal Bracket 	
<b>F</b> Caster, x5 		

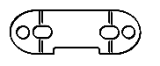
## ATTENTION:

- ⚠ Follow the instructions step by step.
- ⚠ To avoid misalignments, leave the screws loose and do not tighten them until all are in their respective places.
- ⚠ Do not overtighten or force the screws as they could break, strip, or damage the threads of the holes.
- ⚠ Using the wrong size of screws on a part could result in damage to the screw or the part.

### STEP 1

Insert the casters (F) into the legs of the base (C) using pressure, then place the gas lift (E) in the middle of the base, and cover it with (H) as shown.

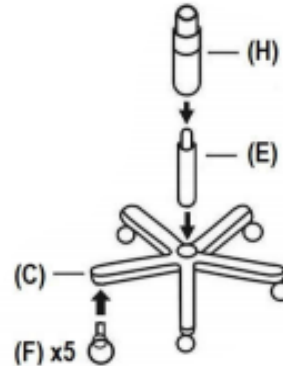

### STEP 2

With the seat positioned as shown, assemble the mechanism (D) to the seat (B) using screws (1) as shown. The handle will be located on the RIGHT when the chair is finished.

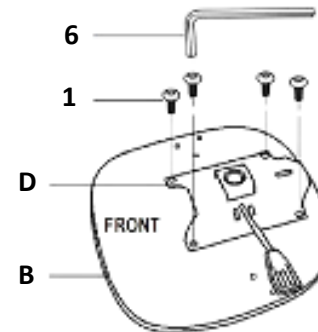

### STEP 3

Assemble the support (G) to the backrest (A) using the cover set (3) and screws (2) as shown.

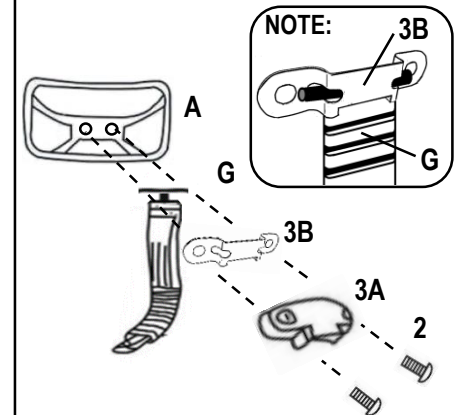

### STEP 4

Secure the support (G) to the mechanism (D) using screw knob (4) and screw (5) as shown.

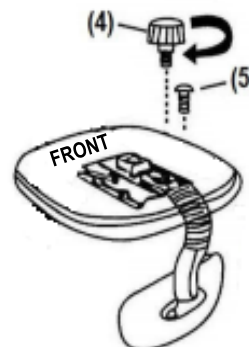

### STEP 5

Place the top over the base, making sure the tip of the gas lift enters into the hole of the mechanism.

Make sure that all the screws are tightened before you sit on the chair for the first time.

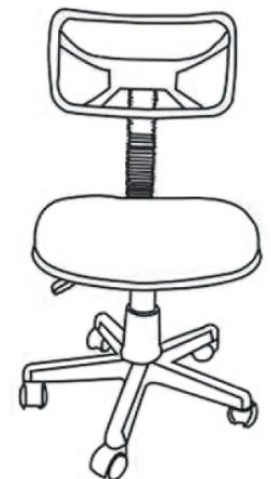

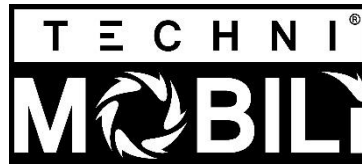

### CHAIR'S FUNCTIONS:

To raise or lower the chair's height, pull UP the lever that is under the seat. The chair goes down while sitting on it, or up if you lift your body.

NOTE: This chair does not recline.

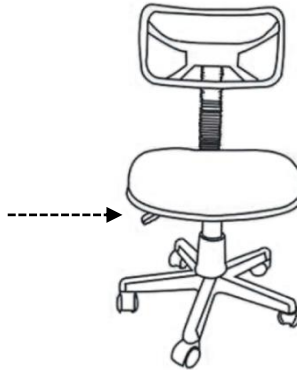

### WARNINGS:

- Do not stand up on the chair or use it as ladder.
- Use the chair to seat only one person at a time.
- Do not use the chair if parts are damaged or if screws are loose or missing.
- Do not seat near the edge of the seat and always sit properly on the chair to avoid going beyond your balance point and fall off the chair.
- The chair is intended for teenagers and adults. If small children are using the chair, please keep close observation on them.
- Do not allow small children to play with the chair.
- Not paying attention to these warnings could result in severe injuries.

### CARE AND MAINTENANCE:

- To clean the chair it is recommended to use a soft cloth lightly damped in a solution of smooth soap and water, then dry with a clean towel.
- Do not use solvents or abrasive materials to clean any part of the chair.
- Before applying a cleaning agent, test on a small hidden area of the chair, like underneath the seat.
- Do not expose the product to direct sunlight or to extreme environmental conditions.
- Every 4 months, inspect the chair completely and make sure that all screws are tighten.