

MODEL RTA-8070

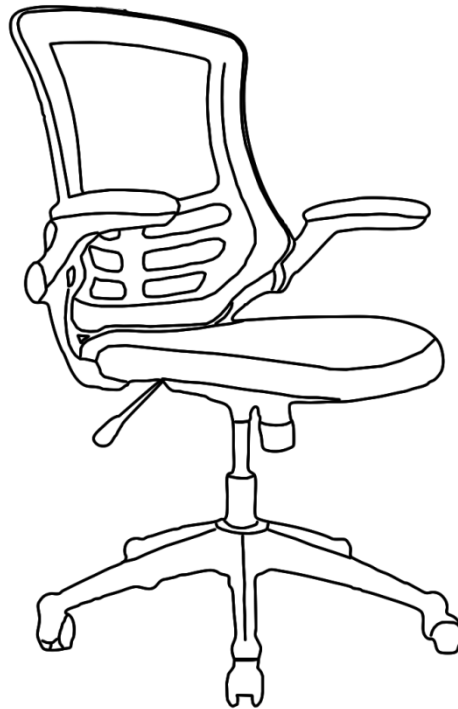





ASSEMBLY INSTRUCTIONS

Thank you for purchasing our product.



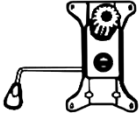



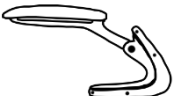

P.1	RTA-8070	P.1
-----	----------	-----

MAIN PARTS LIST

A x1 	B x1 	C x1 	D x1 	E x1 
F x5 	G-L x1 	G-R x1 		

Sitting on the chair, not looking at it

LIST OF HARDWARE

PART	QTY	ITEM	USE IN	
H	4	6x25mm	Armrests to backrest	
I	4	6x20mm	Mechanism	
J	4	6x20mm	Armrests to seat	
K	2	Hole covers: 2 Oval and 2 round	Armrests	Round:  Oval: 
L	1	Allen Wrench		

PARTS LAYOUT (FOR REFERENCE)

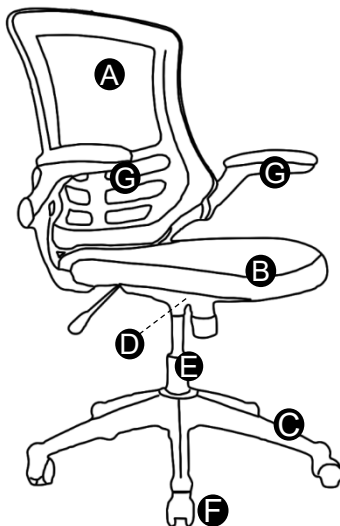

BEFORE YOU START THE ASSEMBLY, PLEASE READ THE FOLLOWING TIPS AND WARNINGS.

1 Do a quick inventory to make sure the package contains all the parts and hardware listed in the assembly instructions.



6 Make sure you understand which hardware will be used on each step. Using the wrong size of screw, bolt or pin might strip the threads or cause damage to the part in which it is being used.

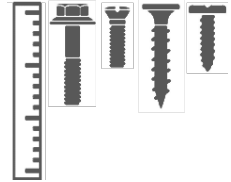

2 Missing, damaged and defective parts can be replaced at no cost to you. Please refer to the last page in this manual.



7 To avoid misalignments, always leave the screws loose and tighten them until all pieces are positioned correctly.

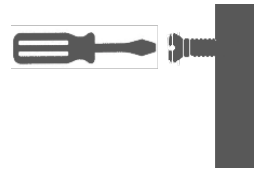

3 The replacement parts service is limited to the continental United States. If you reside in Hawaii, Puerto Rico, U.S. Dependencies or other countries, please contact the supplier from where the unit was purchased.



8 Do not overtighten or force the screws as they might break, strip, damage the threads of the holes or get stuck inside the part.

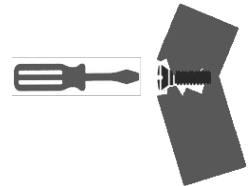

4 If during assembly you find an issue or need clarification, please contact our Customer Service for assistance. Please refer to the last page in this manual.



9 If the hole seems too big or too small for the screw, first make sure you are using the correct size of screw and that it's been installed in the correct hole. Test another of the same screw into the same hole, as well as test the screw onto different holes for the same part. If the hole still appears to be too small, do not force it, it needs replacing.



5 On each step read the instructions and analyze the illustrations thoroughly before proceeding to do the assembly.



ASSEMBLY STEPS

STEP 1

Insert the casters **F** into the legs of the base **C** using pressure, then place the gas lift **E** in the middle of the base as shown.

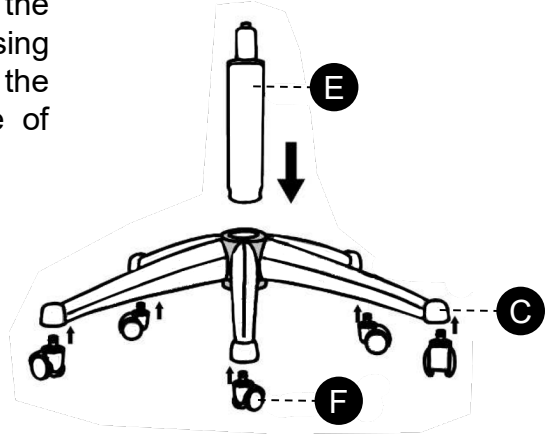

STEP 2

Assemble the mechanism **D** to the seat **B** using screws **I**.

Hardware

I		4 Pcs
---	---	-------

N	
---	---

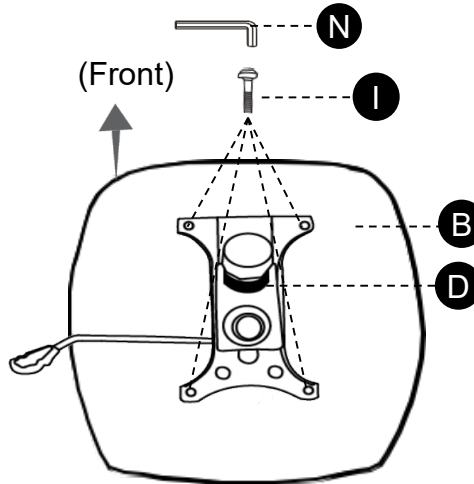

STEP 3

Assemble the armrests **G** to the seat **B** on their respective sides using screws and washers **J** as shown.

Hardware

J		4 Sets
---	---	--------

N	
---	---

Please Note the orientation of the arms

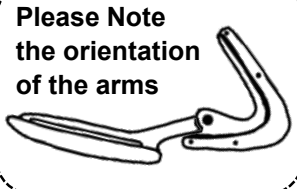
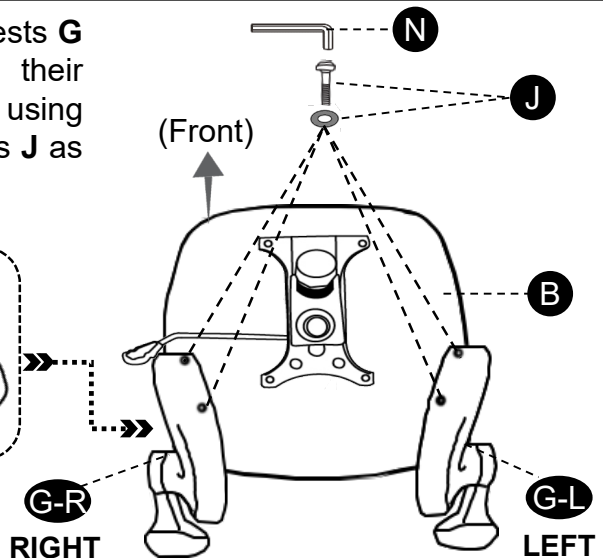
STEP 4

Place the seat over the base parts making sure the tip of the gas lift **E** enters into the hole of the mechanism **D**.

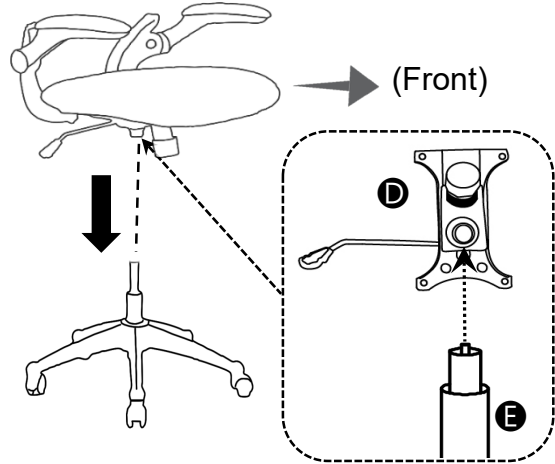

STEP 5

Hardware

H



N



Assemble the backrest **A** to the armrests **G** using screws **H**.

NOTE: If the holes don't want to align, loosen up the screws under the seat (from step 3). When finished, re-tighten those screws.

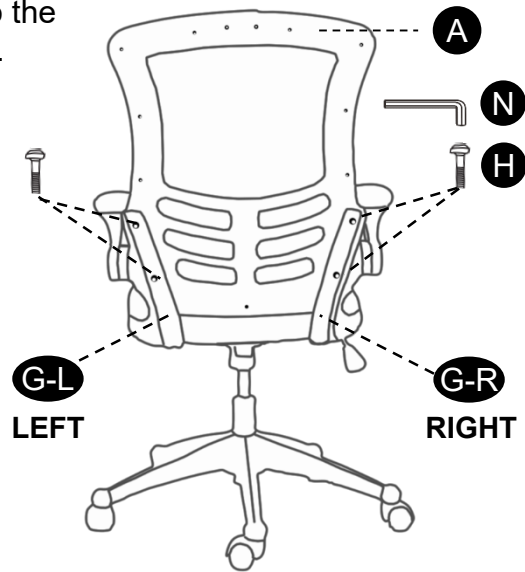

STEP 6

Hardware

M



Use **M** to cover the screw holes on the armrests.

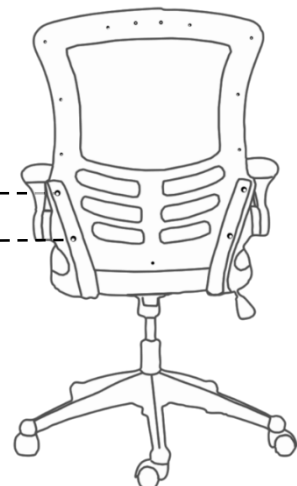
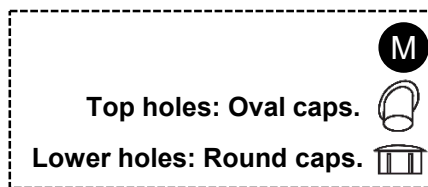

ALL DONE! Give yourself a nice pat on the back. You did a great job!

CHAIR'S FUNCTIONS

- ① To raise or lower the chair's height, pull UP the lever that is under the seat. The chair goes down while sitting on it, or up if you lift your body.
- ② To make the chair tilt freely, pull the same lever OUT horizontally to unlock this function. When the chair is in the normal position, push the lever IN to lock again.
- ③ To adjust the tension for the tilting function, turn the mechanism's knob in either direction to apply more or less tension. With less tension, the tilting will feel easier.
- ④ To use the chair as if it was armless, just flip the arms up.

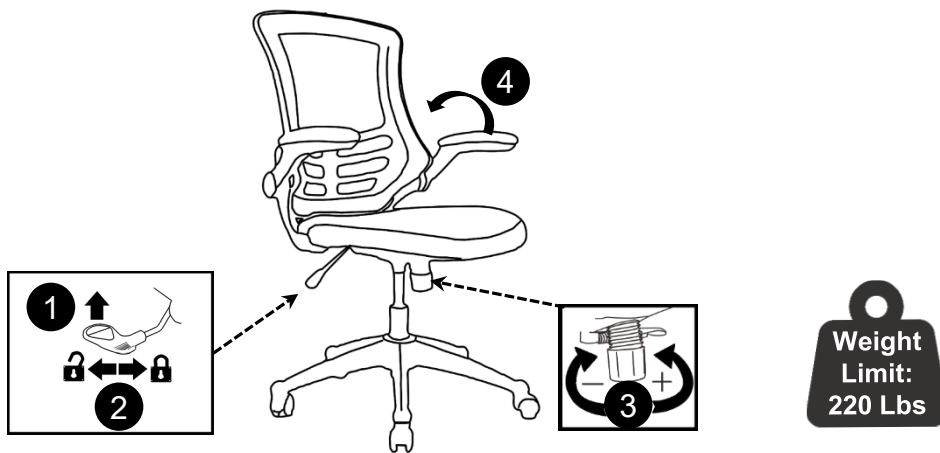

WARNINGS

- Do not exceed the indicated weight limit.
- Do not stand up on the chair or use it as ladder.
- Use the chair to seat only one person at a time.
- Do not use the chair if parts are damaged or if screws are loose or missing.
- Do not sit near the edge of the seat and always sit properly on the chair to avoid going beyond your balance point and fall off the chair.
- The chair is intended for teenagers and adults. If small children are using the chair, please keep close observation on them.
- Do not allow small children to play with the chair.
- Not paying attention to these warnings could result in severe injuries.

CARE AND MAINTENANCE

- To clean the chair it is recommended to use a soft cloth lightly damped in a solution of smooth soap and water, then dry with a clean towel.
- Do not use solvents or abrasive materials to clean any part of the chair.
- Before applying a cleaning agent, test on a small hidden area of the chair, like underneath the seat.
- Do not expose the product to direct sunlight or to extreme environmental conditions.
- Every 4 months, inspect the chair completely and make sure that all screws are tighten.

TECHNI MOBILI CHAIR WARRANTY
TASK/KID'S CHAIR: 1-YEAR WARRANTY
EXECUTIVE/MANAGER CHAIR: 2-YEAR WARRANTY

1.RTA Products, LLC has warranted the Techni Mobili office chairs to the original purchaser who acquired a new product from RTA Products or its authorized resellers of the product against defects in material or workmanship.

2.This warranty is expressly limited to the repair or replacement (at its option) of defective chair components or materials that fails under normal use as a result of a defect in materials or workmanship. This warranty is limited to merchandise purchased in the Continental United States. No assembly labor is included. The word "defects" as used in this warranty, is defined as imperfections that impair the utility of the product.

3.This warranty applies under conditions of normal use, but does not apply to defects that result from intentional damage, negligence, unreasonable use or exposure.

4.Liability for consequential damages is excluded to the extent exclusion is permitted by law. This warranty gives you specific legal rights, and you may have other rights that vary from State to State.

5.RTA Products does not warrant: a) natural variations in character marks b) changes in surface finishes due to aging or exposure to light c) marks, scars, or wrinkles occurring naturally in leather d) failure resulting from normal wear and tear e) the matching of colors, grains, or textures of natural materials f) the colorfastness or the matching of textiles, including an exact match to cuttings or to swatch cards g) damage, marking, or staining of veneer surfaces due to contact with rubber or similar compounds, damage from sharp objects or imprinting from writing instruments, or prolonged exposure to direct sunlight h) we do not warrant products that are exposed to extreme environmental conditions or that have been subject to improper storage.

6.RTA Products shall not be liable for loss of time, inconvenience, commercial loss, or incidental or consequential damages.

7.Any modification to the original product voids the warranty. We do not warrant the performance of the product when used in combination with other than original products.

8.This product has been designed for and is intended for office and home-office use only. This warranty is Original Purchaser's sole remedy for product defects, and this warranty does not extend to any product, or damage to any product, caused by or attributed to abuse or misuse, products used for commercial or rental purposes, use modifications of, or attachments to the product, and products or parts not used, maintained, or extended hereunder is in lieu of any and all other warranties, express or implied, including without limitations any implied warranty or merchantability or of fitness for a particular purpose.

9.Report any defects to RTA Products, LLC together with your sales receipt or other proof of purchase. If the chair is defective within the terms of the warranty, RTA Products, LLC will furnish a replacement chair (at its option) at no cost of equal or similar value and design.

10.RTA Products will advise you of the procedure to follow in making warranty claims. The following are the procedures for warranty claims:

a) Call us Monday – Friday, from 9am-5pm (Eastern Time) at (866) 782-5520 to explain the defect and give your name, address and phone number. Please have ready the model number of our product, date and place of purchase. You can also write to us by e-mail to warranty@rtaproducts.com and include the same information.

b) If we determine that replacement will remedy the situation, and in order to determine the extent or the cause of the defect, purchaser will need to send the part in question at purchaser's expense. Once we receive the part, we will examine it and determine whether the claim is valid (or not), and then proceed to send the replacement. We will ship the replacement at our expense.

FOR SEVERAL HELP OPTIONS INCLUDING REPLACEMENT PARTS ORDERS

VISIT: WWW.TECHNIMOBILI.COM



CLICK ON SUPPORT TAB



Scan QR Code to order replacement parts

OR EMAIL US: SUPPORT@RTAPRODUCTS.COM