

GAMING OFFICE CHAIR

MODEL RTA-2050C

ASSEMBLY INSTRUCTIONS

REV-1-ZK-7841-1223

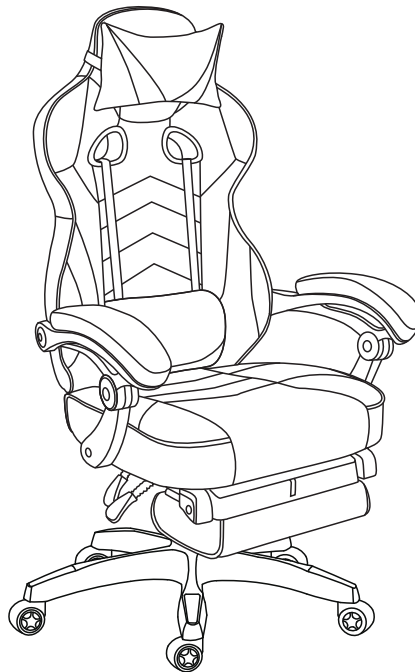







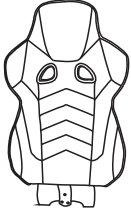
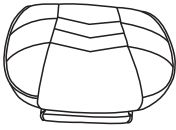

Thank you for purchasing our product

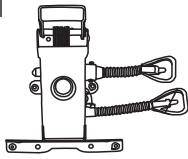

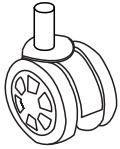
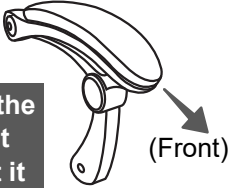

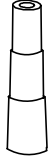
| | | |
|---|---|--|
| <p>Do a quick inventory of all the parts and hardware listed below.</p>  | <p>For Support, assembly questions & Replacement Parts within the 48 Contiguous United States:</p> <p>Please email us at: support@rtaproducts.com</p>  | <p>Replacement Parts for International Customers & AK-HI-PR orders: RTA Products will replace the part free of charge, while the customer is responsible for shipping costs plus any International local taxes or duties.</p> |
|---|---|--|

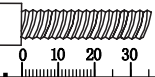
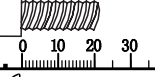

MAIN PARTS LIST

| | | | | | | | | | |
|----------------|--|--|--|--|--|-----------------------|--|----------------|--|
| A x1 | Backrest  | B x1 | Seat  | C x1 | 5-Leg star base  | D x1 | Mechanism  | E x1 | Lift cylinder  |
| F x5 | Caster  | G-L x1 Left armrest  Sitting on the chair, not looking at it | | G-R x1 Right armrest  (Front) Sitting on the chair, not looking at it | | H x1 Set | Covers for lift cylinder  | | |
| I x1 | Lumbar pillow  | J x1 | Neck pillow  | | | | | | |

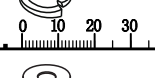
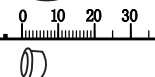
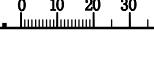
HARDWARE LIST

| Part # | QTY | SIZE/Description | Item |
|--------|-----|------------------|---|
| K | 4 | M8x35 |  |
| L | 3 | M8x20 |  |
| M | 4 | M6x20 |  |
| N | 3 | Ø8, Ø12 O-Ring |  |
| O | 7 | Ø8, Ø17 Washer |  |
| P | 4 | Ø18 Caps |  |

INCLUDED TOOLS

| | | |
|---|-----------------|---|
| 1 | M5 Allen Wrench |  |
| 1 | M4 Allen Wrench |  |

If you will use your own power driver:

- Make sure to have on hand the appropriate bits and sizes.
- Start using at a low torque or speed to avoid stripping the screws.

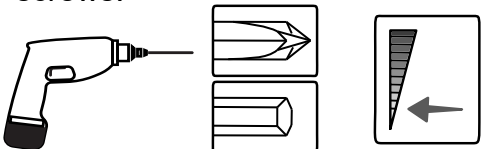

BEFORE YOU START THE ASSEMBLY, PLEASE READ THE FOLLOWING TIPS AND WARNINGS.

- Do not discard this manual or any of the packaging material until the unit is completely assembled.
- Please read the assembly instructions thoroughly and follow step by step.



- Make sure you understand which hardware will be used on each step. Using the wrong size of screw, bolt or pin might strip the threads or cause damage to the part in which it is being used.

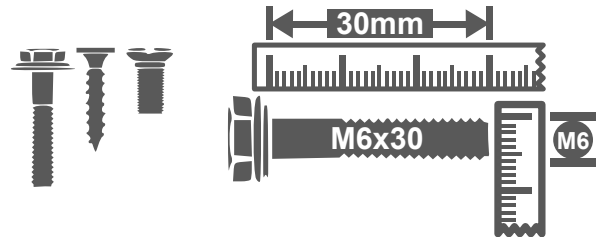

- To avoid misalignments, always leave the screws loosely and do not tighten them until all the pieces are positioned correctly.

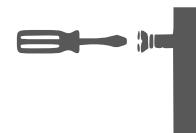

- Do not overtighten or force the screws as they might break, strip, damage the threads of the holes, or get stuck inside the parts.

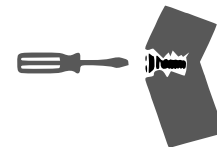

- If the hole seems too small for the screw, make sure you are using the correct size of screw and/or that you are installing it in the correct hole.



- Sometimes the fabric or material might cover partially or entirely the screw hole, making the hole appear to be too small or not visible at all.

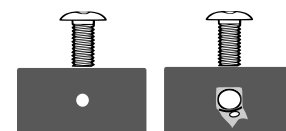

ASSEMBLY STEPS

STEP 1

Hardware

| | | |
|---|--|----------|
| M |  M6x20 | 4 Pcs |
|---|--|----------|

| | | |
|---|--|----------|
| O |  Ø8, 17Ø | 4 Pcs |
|---|--|----------|

Tools (included)



Turn over the seat **B** and assemble the mechanism **D** with screws **M** and washers **O**.

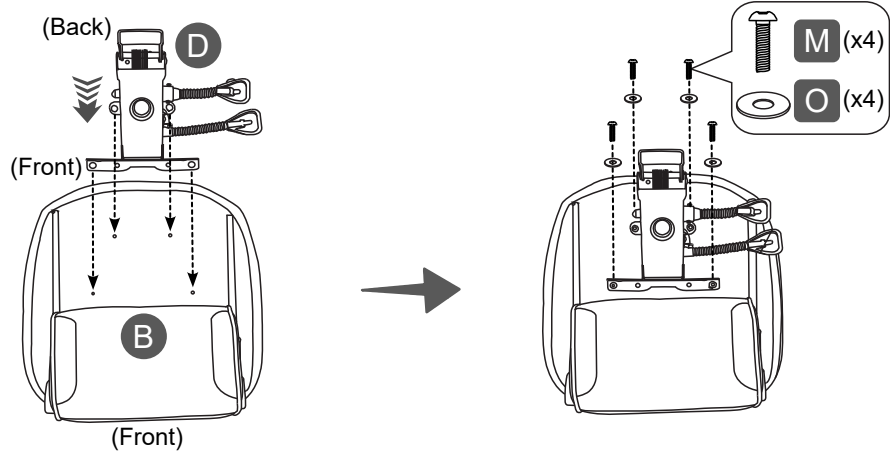

STEP 2

Insert the casters **F** into each leg of the base **C** using pressure, then place the lift cylinder **E** in the middle of the base and cover it with **H**.

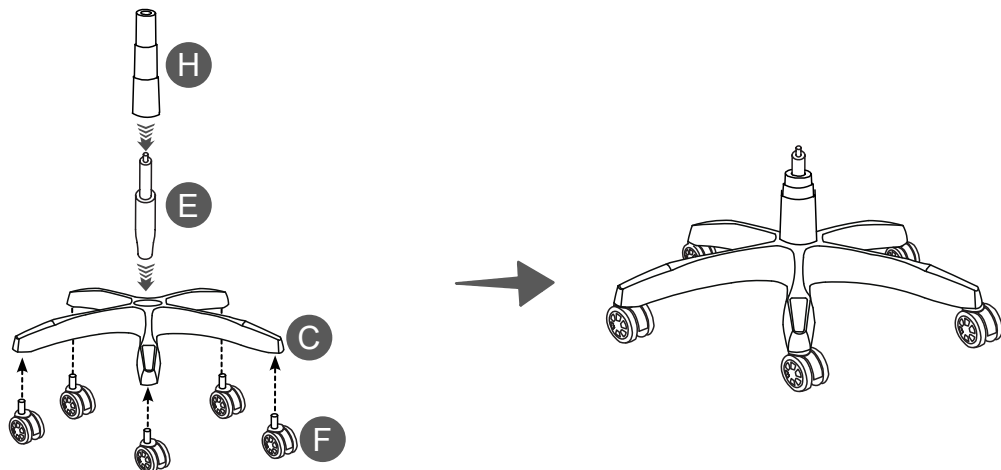

STEP 3

Join the seat to the base parts making sure the tip of the cylinder **E** enters correctly into the hole of the mechanism **D**.

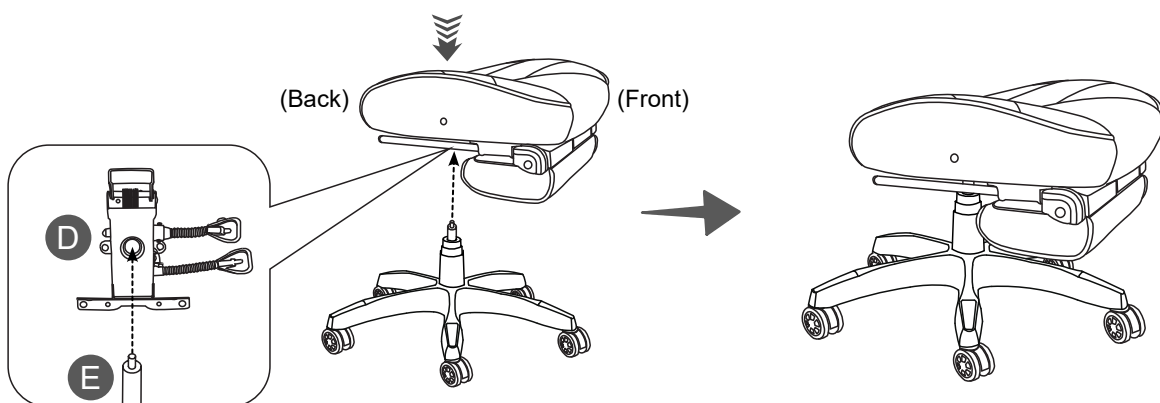

STEP 4

Attach the lumbar pillow **I** and the neck pillow **J** to the backrest **A** by fastening the buckles on the other side as shown.

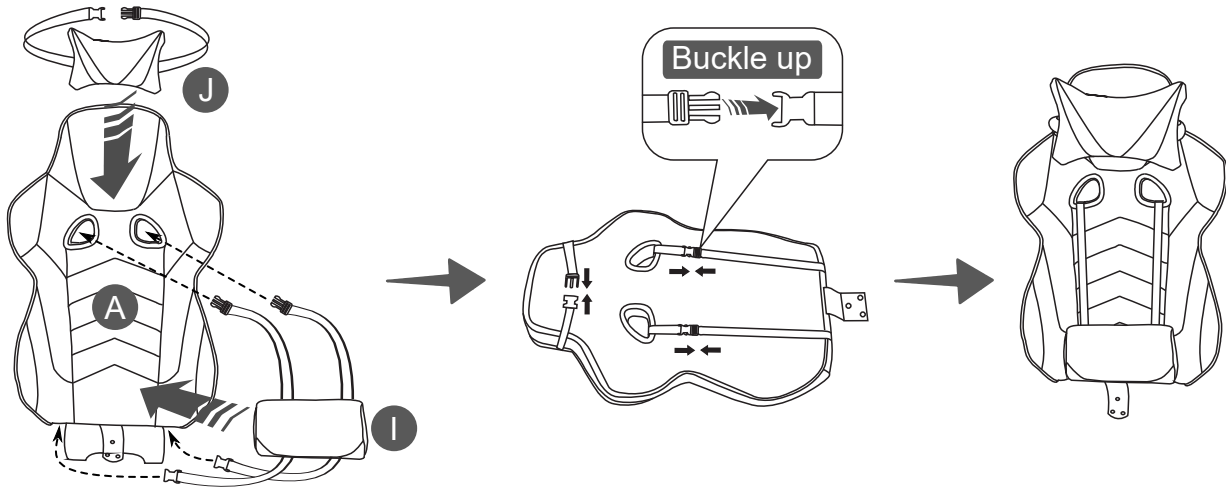

STEP 5

Hardware

| | | |
|---|---------|-------|
| L | M8x20 | 3 Pcs |
| N | Ø8, Ø12 | 3 Pcs |
| O | Ø8, Ø17 | 3 Pcs |

Tools (included)



First assemble the metal plate from the backrest **A** inside the plate of the mechanism **D** with screws **L**, O-Rings **N** and washers **O** as shown. Pay attention to the order of **N** and **O**. Then attach the hanging side covers under the seat **B**.

FIRST

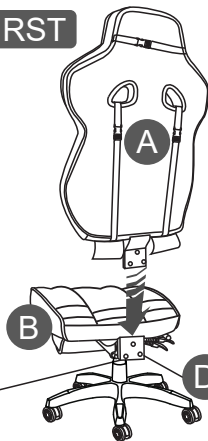

THEN

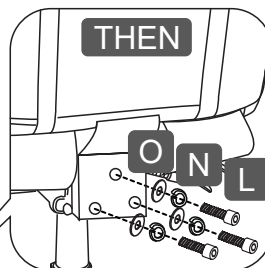

LAST



The plate from **A** goes inside of **D**.

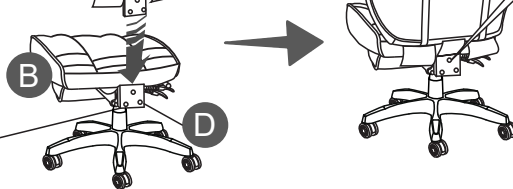

STEP 6

Hardware

| | | |
|---|-------|-------|
| K | M8x35 | 4 Pcs |
| P | Cap | 4 Pcs |

Tools (included)



FIRST assemble the armrests **G-L**, **G-R** to the seat **B** in their respective sides with screws **K** BUT LEAVE THEM LOOSE to allow flexibility. **THEN** assemble the armrests to the backrest **A** with screws **K**. **LASTLY**, proceed to tighten all the screws, and cover the holes with **P**.

FIRST

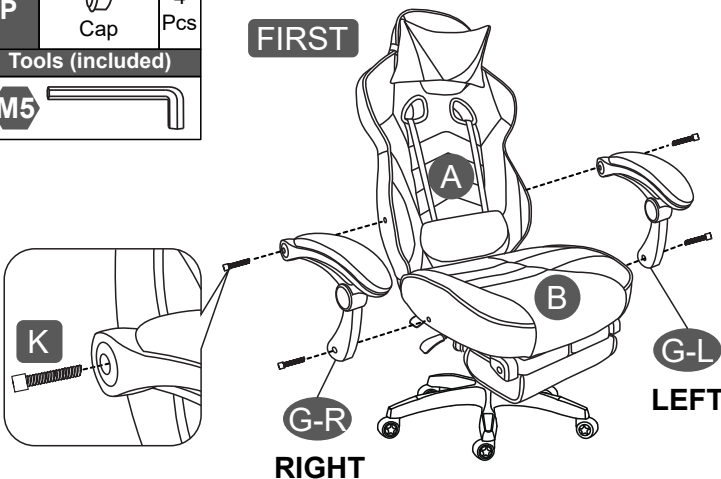

THEN

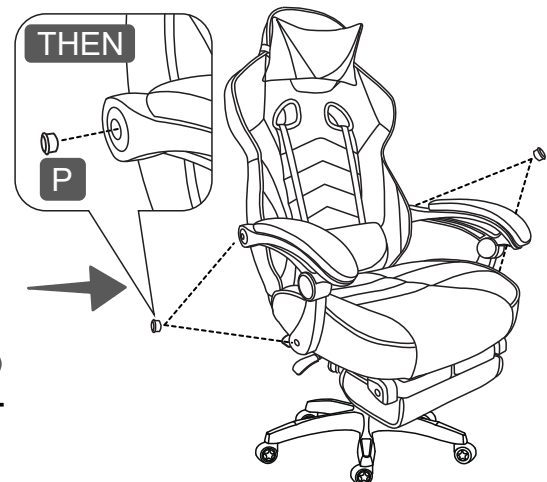

CHAIR'S FUNCTIONS

- ① To raise or lower the chair's height, pull UP the first lever (the one under the seat on the right side). The chair goes down while sitting on it, or up if you lift your body.
 - ② To recline the backrest, pull UP the second lever. The backrest will recline freely when the lever is in the UP position. To lock the backrest at a desired angle, push the same lever DOWN.
 - ③ Pull OUT the footrest from under the seat and flip the cushion over. To close it, first flip DOWN the cushion and then push it IN below the seat.
- ⚠ **WARNING:** For your safety, NEVER try to get off the chair while the footrest is EXTENDED, you must close it first.

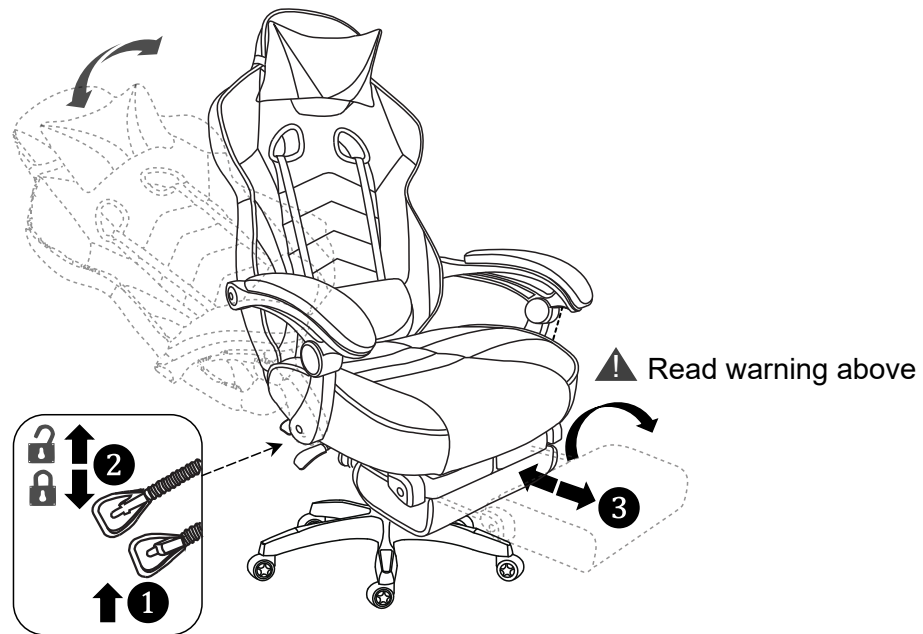

WARNINGS

- Do not exceed the indicated weight limit.
- Do not use if parts are bent, damaged, or if screws are loose or missing.
- Only one person at a time can sit on the chair.
- Do not sit babies or toddlers alone.
- If children (3 years and older) are sitting on the chair, always keep close observation on them.
- Do not allow small children to play with the chair.
- Do not stand up on the chair or use it as ladder.
- Do not sit too close to the edge of the seat to avoid going beyond your balance point and falling off the chair, and always sit properly.
- Not paying attention to these warnings could result in injuries.

WEIGHT LIMIT



CARE AND MAINTENANCE

- To clean the chair it is recommended to use a soft cloth lightly damped in a solution of smooth soap and water, then dry with a clean towel.
- Do not use solvents or abrasive materials to clean any part of the chair.
- Before using a cleaning agent, test on a small hidden area of the chair, like underneath the seat.
- Do not expose the product to direct sunlight or to extreme environmental conditions.
- Inspect the chair completely every 4 months and make sure that all screws are tightened.

TECHNI MOBILI WARRANTY**EXECUTIVE/MANAGER CHAIR: 2-YEAR WARRANTY**

RTA Products, LLC has warranted the Techni Mobili office chairs to the original purchaser who acquired a new product from RTA Products or its authorized resellers of the product against defects in material or workmanship.

This warranty is expressly limited to the repair or replacement (at its option) of defective chair components or materials that fails under normal use as a result of a defect in materials or workmanship. This warranty is limited to merchandise purchased in the Continental United States, excludes AK, HI and PR. No assembly labor is included. The word "defects" as used in this warranty, is defined as imperfections that impair the utility of the product.

This warranty applies under conditions of normal use, but does not apply to defects that result from intentional damage, negligence, unreasonable use or exposure.

Liability for consequential damages is excluded to the extent exclusion is permitted by law. This warranty gives you specific legal rights, and you may have other rights that vary from State to State.

RTA Products does not warrant: a) natural variations in character marks b) changes in surface finishes due to aging or exposure to light c) marks, scars, or wrinkles occurring naturally in leather d) failure resulting from normal wear and tear e) the matching of colors, grains, or textures of natural materials f) the colorfastness or the matching of textiles, including an exact match to cuttings or to swatch cards g) damage, marking, or staining of veneer surfaces due to contact with rubber or similar compounds, damage from sharp objects or imprinting from writing instruments, or prolonged exposure to direct sunlight h) we do not warrant products that are exposed to extreme environmental conditions or that have been subject to improper storage.

RTA Products shall not be liable for loss of time, inconvenience, commercial loss, or incidental or consequential damages.

Any modification to the original product voids the warranty. We do not warrant the performance of the product when used in combination with other than original products.

This product has been designed for and is intended for office and home-office use only. This warranty is Original Purchaser's sole remedy for product defects, and this warranty does not extend to any product, or damage to any product, caused by or attributed to abuse or misuse, products used for commercial or rental purposes, use modifications of, or attachments to the product, and products or parts not used, maintained, or extended hereunder is in lieu of any and all other warranties, express or implied, including without limitations any implied warranty or merchantability or of fitness for a particular purpose.

To file a Claim within the 48 contiguous United States: Email us to warranty@rtaproducts.com to explain the defect and provide your name, address, phone number, model number of our product, date and place, and proof of purchase. Please provide pictures of the damage or defect.

If we determine that a replacement will remedy the situation, and in order to determine the extent or the cause of the defect, purchaser may be requested to send the part in question at purchaser's expense. Once we receive the part, we will examine it and determine whether the claim is valid (or not), and then proceed to send the replacement. We will ship the replacement at our expense.

Replacement Parts for International Customers & AK-HI-PR orders: RTA Products will replace the part free of charge, while the customer is responsible for shipping costs plus any International local taxes or duties.