













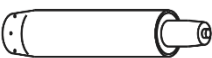

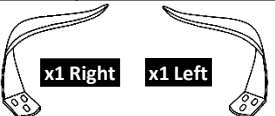

ASSEMBLY INSTRUCTIONS

CHAIR STYLE RTA-2023

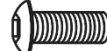
PARTS LIST

ATTENTION: Before you begin to assemble the product, please make sure that all the parts are included in the package and in good condition.

A x1 Backrest 	B x1 Seat 
C x1 5-Star base 	D x1 Mechanism 
E x1 Hydraulic Gas Lift 	F x5 Casters 
G Armrests  x1 Right x1 Left When you seat on the chair, not looking at it.	
H x1 Covers for Gas Lift (Set) 	I x1 Headrest 
J x1 Headrest Cover 	K x4 M6x20mm (Mechanism) 
L x4 M6x16mm (Armrests to backrest) 	M x4 M6x35mm (Backrest to seat) 
N x6 M6x25mm (Armrests to seat) 	O x4 M5x18mm (Headrest) 
P x10 Ø15xØ6x1.5mm (Armrests) 	Q x1 Allen Wrench M5 

ATTENTION:

- Follow the instructions step by step.
- To avoid misalignments, leave the screws loose and do not tighten them until all are in their respective places.
- Do not overtighten or force the screws as they could break, strip, or damage the threads of the holes.
- Using the wrong size of screws on a part could result in damage to the screw or the part

1 Insert the casters (F) in the legs of the base (C) using pressure, then place the gas lift (E) in the middle of the base and cover it with (H) as shown.

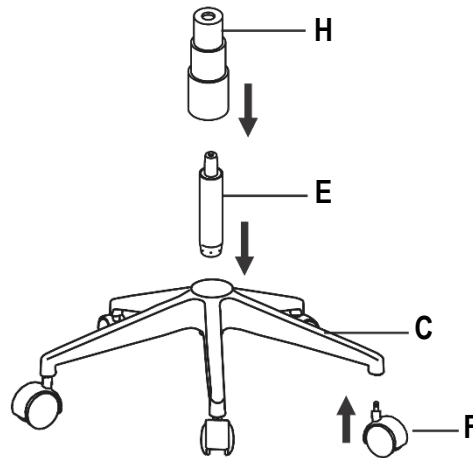

2 Flip over the seat (B) with its front end towards you, and using screws (K), assemble the mechanism (D) with its knob facing to the FRONT as shown.

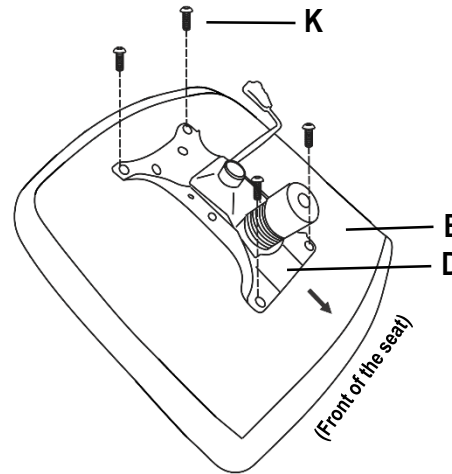

3 Assemble the armrests (G) in the respective sides of the backrest (A) using screws (L) as shown.

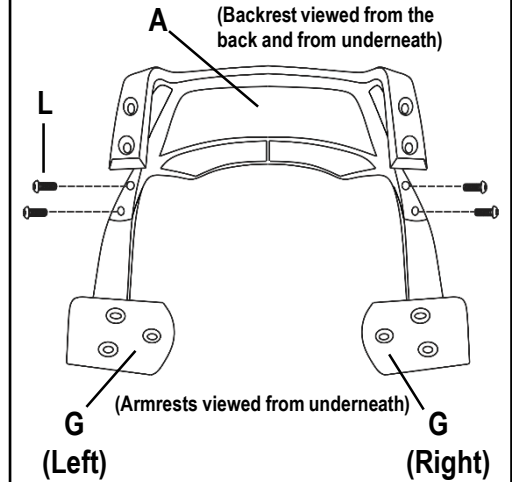

4 Assemble the backrest (A) to the seat (B) using screws (M) and washers (P), and the armrests (G) to the seat using screws (N) and washers (P) as shown.

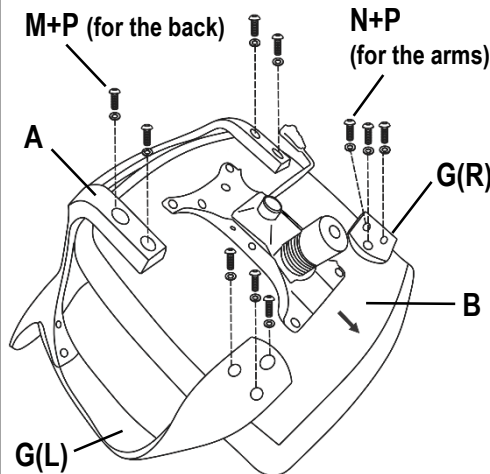

5 Place the top parts over the base parts making sure the tip of the gas lift enters into the hole of the mechanism.

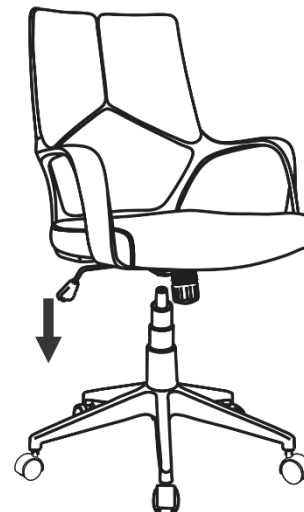

6 Assemble the headrest (I) to the backrest (A) using screws (O), then cover with (J) as shown.

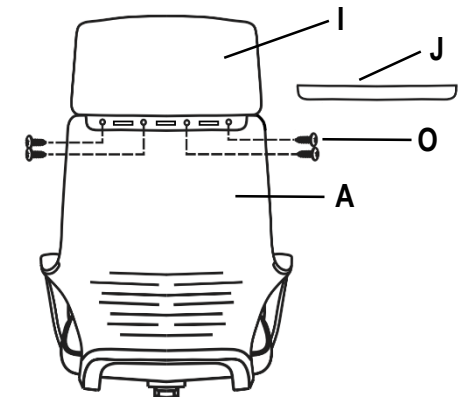

Before seating and using the chair for the first time, make sure that all screws are properly tightened.

CHAIR'S FUNCTIONS:

- (1) Chair height: Pull UP the lever that is under the seat. The chair goes down while sitting on it, or up if you lift your body.
- (2) Chair tilting: Pull the same lever OUT horizontally to unlock this function. While unlocked, the chair will tilt freely. When the chair is in the normal position, push the lever IN to lock the tilting function.
- (3) Tilting tension: Turn the mechanism's knob in either direction to apply more or less tension. With less tension, the tilting will feel more easy.

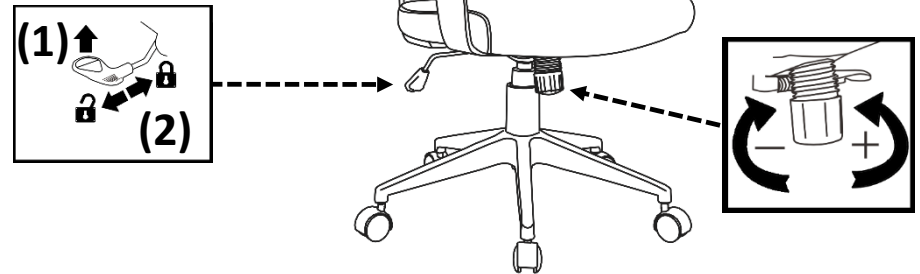

WARNINGS:

- Do not stand up on the chair or use it as ladder.
- Use the chair to seat only one person at a time.
- Do not use the chair if parts are damaged or if screws are loose or missing.
- Do not seat near the edge of the seat and always sit properly on the chair to avoid going beyond your balance point and fall off the chair.
- The chair is intended for teenagers and adults. If small children are using the chair, please keep close observation on them.
- Do not allow small children to play with the chair.
- Not paying attention to these warnings could result in severe injuries.

CUCARE AND MAINTENANCE:

- To clean the chair it is recommended to use a soft cloth lightly damped in a solution of smooth soap and water, then dry with a clean towel.
- Do not use solvents or abrasive materials to clean any part of the chair.
- Before applying a cleaning agent, test on a small hidden area of the chair, like underneath the seat.
- Do not expose the product to direct sunlight or to extreme environmental conditions.
- Every 4 months, inspect the chair completely and make sure that all screws are tighten.