

**HIGH BACK EXECUTIVE MESH OFFICE CHAIR**

# **MODEL RTA-1010**

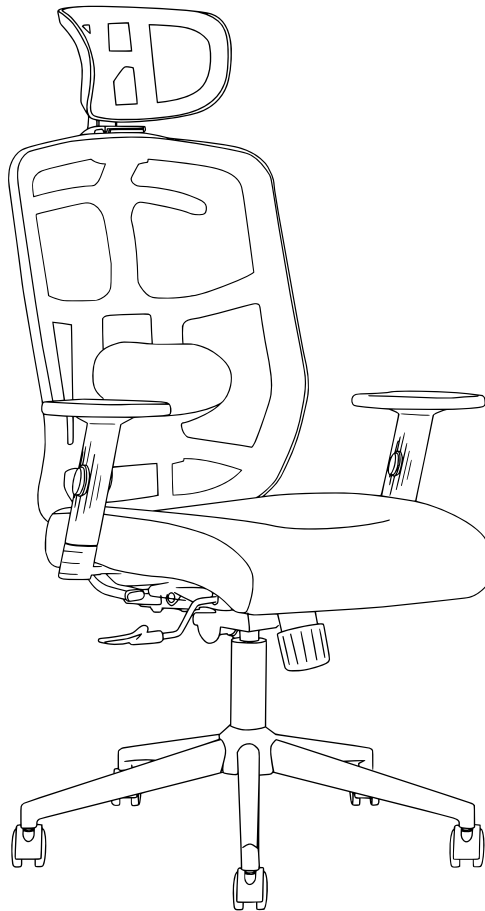

## **ASSEMBLY INSTRUCTIONS**

Thank you for purchasing our product









REV.ZX-6890-0922



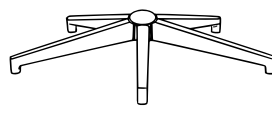
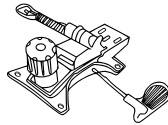
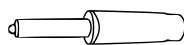

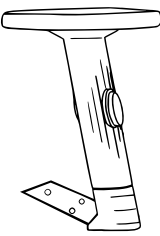
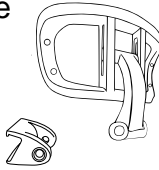
<p>Do a quick inventory of all the parts and hardware listed below</p> 	<p>Missing, damaged and defective parts can be replaced at no cost to you. Please refer to the last pages on this manual.</p> 	<p>The replacement parts service is limited to the 48 contiguous United States. If you reside in AK, HI, PR, U.S. territories or other countries, please contact the supplier from where the unit was purchased.</p> 
--	---	--

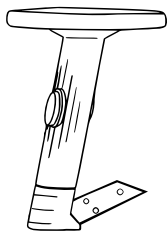
### MAIN PARTS LIST

<b>A</b> Backrest x1 	<b>B</b> Seat x1 	<b>C</b> 5-Leg star base x1 	<b>D</b> Mechanism with 2 levers x1 
<b>E</b> Lift cylinder x1 	<b>F</b> Caster x5 	<b>G-L</b> Left armrest x1 	
<b>H</b> Headrest with base x1 	<b>I</b> Base cover x1 	<b>G-R</b> Right armrest x1 	

Sitting on the chair, not looking at it

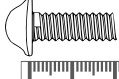
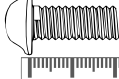
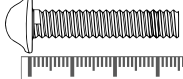
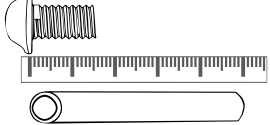
### HARDWARE LIST

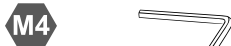
PART	QTY	SIZE	ITEM	USE IN
J	6	M6x25		Armrests
K	4	M6x20		Mechanism
L	3	M8x20		Backrest
M	1	M6x35		Headrest base
N	1 Set	M8x15 Screw Ø8x60 tube		Headrest
O	7	M8 Washer		Mechanism, backrest
	1	M5 Allen Wrench		Steps 1, 2, 3 & 6
	1	M4 Allen Wrench		Step 6

**BEFORE YOU START THE ASSEMBLY, PLEASE READ THE FOLLOWING TIPS AND WARNINGS.**

- Do not discard this manual or any of the packaging material until the unit has been completely assembled.



- If during assembly you find an issue or need clarification, please contact our Customer Service for assistance. Please refer to the last pages on this manual.



- On each step read the instructions thoroughly and analyze the illustrations before proceeding to do the assembly.
- Follow the instructions step by step and do not skip any unless our Customer Service advises it is OK to do so.



- Make sure you understand which hardware will be used on each step. Using the wrong size of screw, bolt or pin might strip the threads or cause damage to the part in which it is being used.

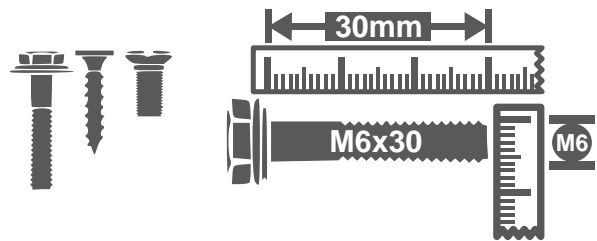

- To avoid misalignments, always leave the screws loose and tighten them until all pieces are positioned correctly.

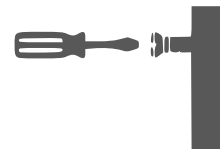

- Do not overtighten or force the screws as they might break, strip, damage the threads of the holes or get stuck inside the part.

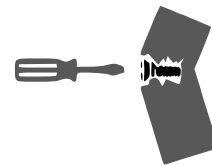

- If the hole seems too small for the screw, make sure you are using the correct size of screw and/or that you are installing it in the correct hole.



- Sometimes the fabric or material might cover partially or entirely the screw hole, making the hole appear to be too small.

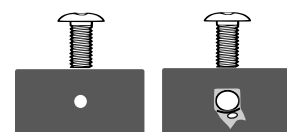

ASSEMBLY STEPS

STEP 1

Hardware

J		6 Pcs
	M6x25	



Turn over the seat **B** and assemble the armrests **G-L**, **G-R** in their respective sides with screws **J**. Please note that the armrest side (left or right) is you sitting on the chair, not looking at it.

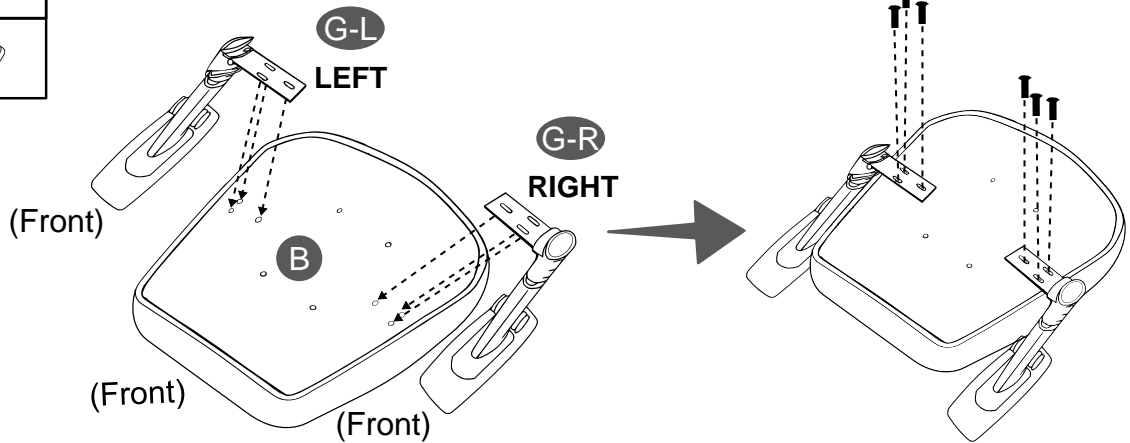

STEP 2

Hardware

K		4 Pcs
	M6x20	

O		4 Pcs
	Washer	



Place the mechanism **D** over the seat **B** making sure the tension knob faces towards the front, then secure it with screws **K** and washers **O**.

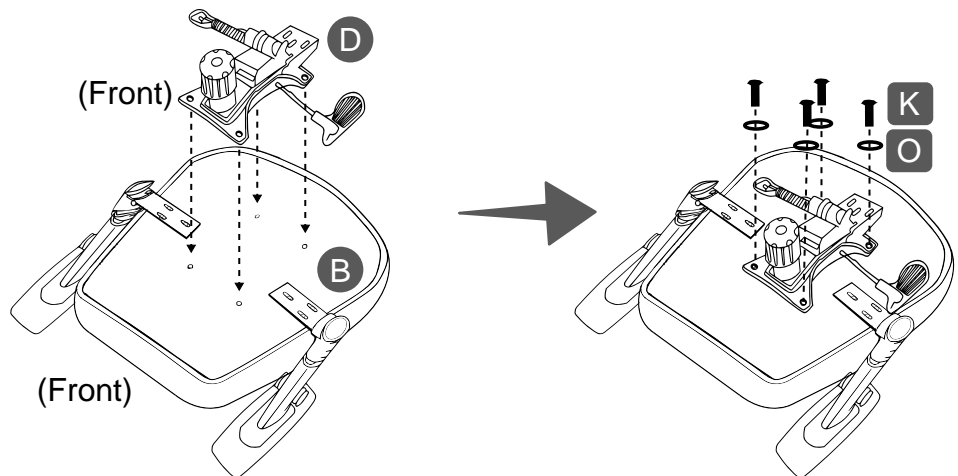

STEP 3

Hardware

L		3 Pcs
	M8x20	

O		3 Pcs
	Washer	



Insert the metal plate of the backrest **A** under the plate of the mechanism **D** and secure it with screws **L** and washers **O**. The screws go through **D** and into **A**.

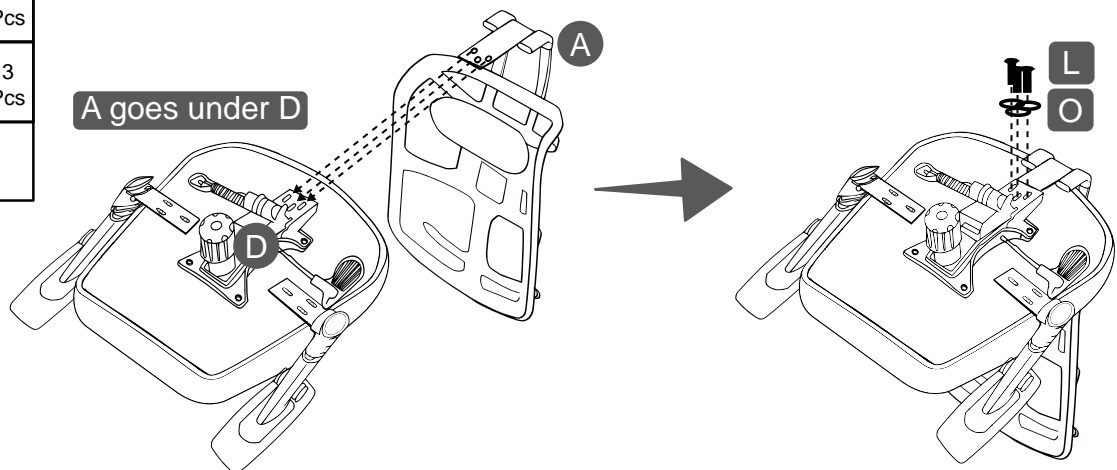

**STEP 4**

Insert the casters **F** into the legs of the base **C** using pressure, then place the lift **E** and the cover **I** in the middle of the base.

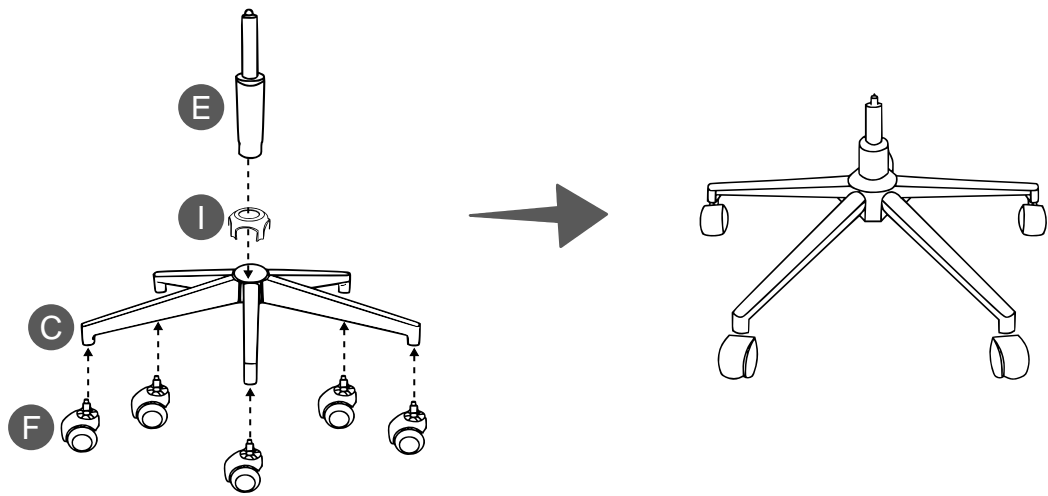



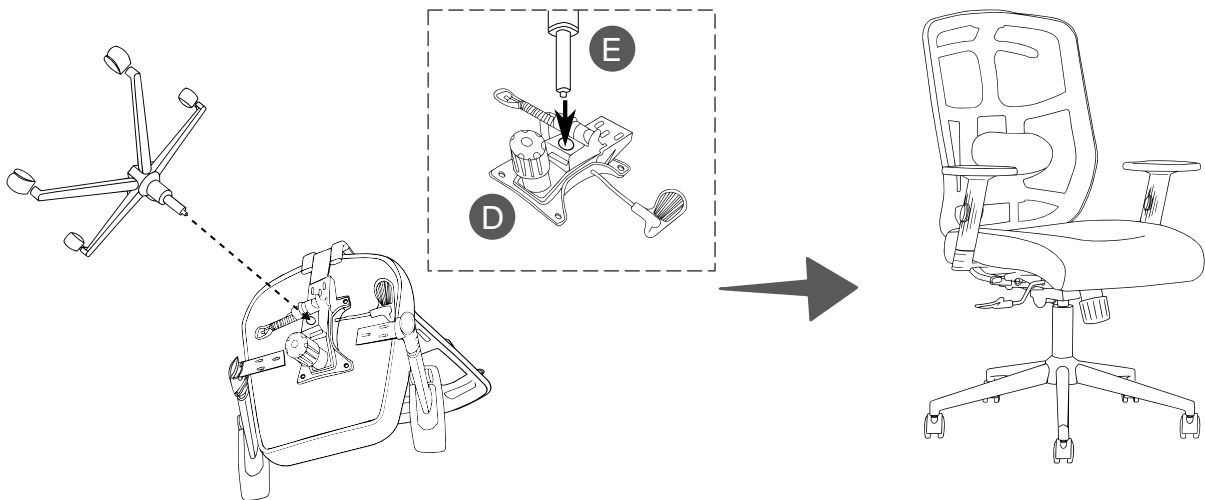

**STEP 5**

Join the base parts to the seat making sure the tip of the lift **E** enters correctly into the hole of the mechanism **D**.



**STEP 6**

**Hardware**

<b>M</b>	 M6x35	1 Pcs
<b>N</b>	 M8x15 Ø8x60	1 Set
<b>M4</b>		
<b>M5</b>		

First assemble the base of the headrest **H** to the backrest **A** with screw **M** (use tool size M4), then assemble the headrest to its base with the screws and tube set **N** (use tool size M5) as shown.

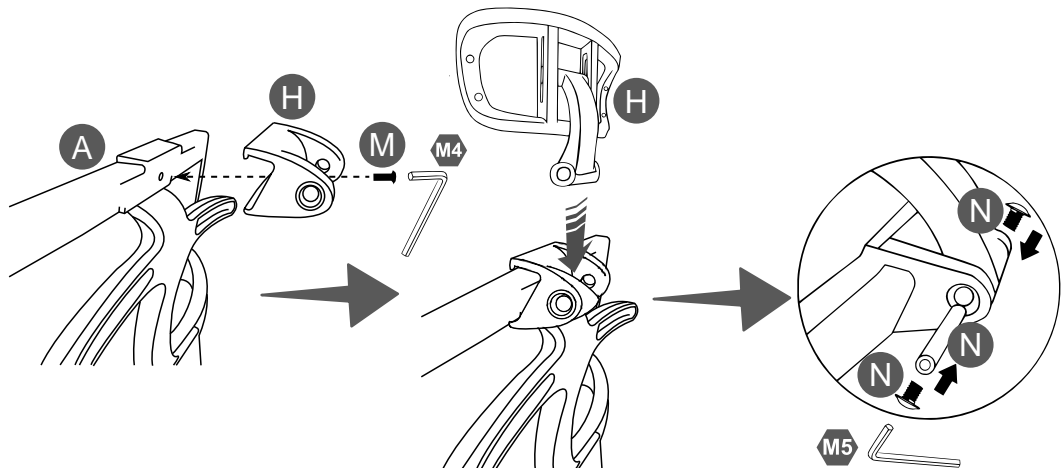

### CHAIR'S FUNCTIONS

- ① To raise or lower the chair's height, pull UP the lever that is under the seat on the right side. The chair goes down while sitting on it, or up if you lift your body.
- ② To make the backrest recline freely, pull UP the lever that is under the seat on the left side. To lock the reclining in a desired angle, push the lever DOWN. To unlock and recline again, pull the lever UP and push back on the backrest.
- ③ To adjust the tension for the reclining function, turn the mechanism's knob in either direction to apply more or less tension. With less tension, the reclining will feel easier.
- ④ To adjust the armrest height, press the button that is on the outside of the armrest and release it once the desired height is reached.
- ⑤ Turn the knob on the backrest on either direction to adjust the depth of the lumbar support.
- ⑥ The headrest can be adjusted up and down and pivots back and forward.

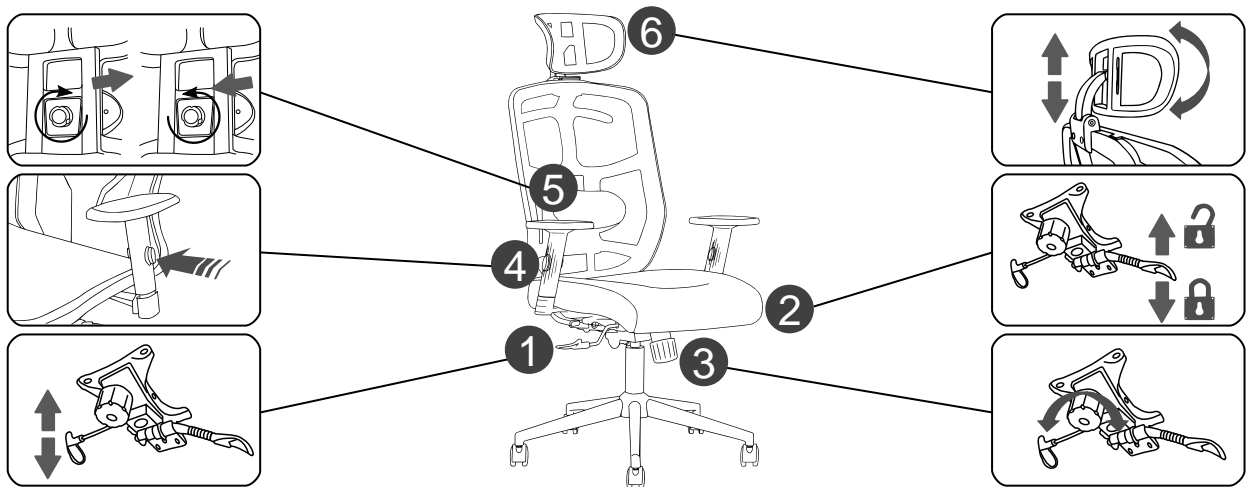

### WEIGHT LIMIT AND WARNINGS

- Do not exceed the indicated weight limit.
- Do not stand up on the chair or use it as ladder.
- Only one person at a time can sit on the chair.
- Do not use the chair if parts are damaged or if screws are loose or missing.
- Do not sit near the edge of the seat to avoid going beyond your balance point and falling off the chair, and always sit properly.
- If small children are sitting on the chair, please keep close observation on them.
- Do not allow small children to play with the chair.
- Not paying attention to these warnings could result in injuries.



### CARE AND MAINTENANCE

- To clean the chair it is recommended to use a soft cloth lightly damped in a solution of smooth soap and water, then dry with a clean towel.
- Do not use solvents or abrasive materials to clean any part of the chair.
- Before using a cleaning agent, test on a small hidden area of the chair, like underneath the seat.
- Do not expose the product to direct sunlight or to extreme environmental conditions.
- Every 4 months, inspect the chair completely and make sure that all screws are tighten.

**TECHNI MOBILI CHAIR WARRANTY**

TASK/KID'S/DINING/VISITOR'S CHAIR: 1-YEAR WARRANTY

EXECUTIVE/MANAGER/GAMING CHAIR: 2-YEAR WARRANTY

1. RTA Products, LLC has warranted the Techni Mobili office chairs to the original purchaser who acquired a new product from RTA Products or its authorized resellers of the product against defects in material or workmanship.
2. This warranty is expressly limited to the repair or replacement (at its option) of defective chair components or materials that fails under normal use as a result of a defect in materials or workmanship. This warranty is limited to merchandise purchased in the Continental United States, excludes AK, HI and PR. No assembly labor is included. The word "defects" as used in this warranty, is defined as imperfections that impair the utility of the product.
3. This warranty applies under conditions of normal use, but does not apply to defects that result from intentional damage, negligence, unreasonable use or exposure.
4. Liability for consequential damages is excluded to the extent exclusion is permitted by law. This warranty gives you specific legal rights, and you may have other rights that vary from State to State.
5. RTA Products does not warrant: a) natural variations in character marks b) changes in surface finishes due to aging or exposure to light c) marks, scars, or wrinkles occurring naturally in leather d) failure resulting from normal wear and tear e) the matching of colors, grains, or textures of natural materials f) the colorfastness or the matching of textiles, including an exact match to cuttings or to swatch cards g) damage, marking, or staining of veneer surfaces due to contact with rubber or similar compounds, damage from sharp objects or imprinting from writing instruments, or prolonged exposure to direct sunlight h) we do not warrant products that are exposed to extreme environmental conditions or that have been subject to improper storage.
6. RTA Products shall not be liable for loss of time, inconvenience, commercial loss, or incidental or consequential damages.
7. Any modification to the original product voids the warranty. We do not warrant the performance of the product when used in combination with other than original products.
8. This product has been designed for and is intended for office and home-office use only. This warranty is Original Purchaser's sole remedy for product defects, and this warranty does not extend to any product, or damage to any product, caused by or attributed to abuse or misuse, products used for commercial or rental purposes, use modifications of, or attachments to the product, and products or parts not used, maintained, or extended hereunder is in lieu of any and all other warranties, express or implied, including without limitations any implied warranty or merchantability or of fitness for a particular purpose.
9. Report any defects to RTA Products, LLC together with your sales receipt or other proof of purchase. If the chair is defective within the terms of the warranty, RTA Products, LLC will furnish a replacement chair (at its option) at no cost of equal or similar value and design.
10. RTA Products will advise you of the procedure to follow in making warranty claims. The following are the procedures for warranty claims:
  - a) Call us Monday – Friday, from 9am-5pm (Eastern Time) at (866) 782-5520 to explain the defect and give your name, address and phone number. Please have ready the model number of our product, date and place of purchase. You can also write to us by e-mail to [warranty@rtaproducts.com](mailto:warranty@rtaproducts.com) and include the same information.
  - b) If we determine that replacement will remedy the situation, and in order to determine the extent or the cause of the defect, purchaser will need to send the part in question at purchaser's expense. Once we receive the part, we will examine it and determine whether the claim is valid (or not), and then proceed to send the replacement. We will ship the replacement at our expense.

# FOR SEVERAL HELP OPTIONS INCLUDING REPLACEMENT PARTS ORDERS

---

VISIT: [WWW.TECHNIMOBILI.COM](http://WWW.TECHNIMOBILI.COM)

🖱️ AND CLICK ON SUPPORT TAB

Or scan the following QR Code:



Scan the following QR Code to order replacement parts:



EMAIL US:

[support@rtaproducts.com](mailto:support@rtaproducts.com)

