

**READ ME !** ⚠

Thank you for purchasing a Front Runner 40" LED Light Bar Brackets.

Before you start, take a moment to familiarize yourself with the Fitting Instructions and the components received.

Refer to Page 2 for a list of all the components, quantities and tools required.

**NOTE:** Front Runner will not be responsible for any damage caused by the failure to install the product according to these instructions.  
Please call us if you have any questions about the installation of this product.

**IMPORTANT WARNING!** ⚠

FRONT RUNNER CAN NOT RECOMMEND A MAXIMUM LOAD CARRYING CAPACITY. PLEASE REFER TO YOUR VEHICLE MANUFACTURER'S RECOMMENDATIONS. IT IS CRITICAL THAT ALL FRONT RUNNER PRODUCTS BE PROPERLY AND SECURELY ASSEMBLED AND ATTACHED TO YOUR VEHICLE. IMPROPER ATTACHMENT COULD RESULT IN AN AUTOMOBILE ACCIDENT, AND COULD CAUSE SERIOUS BODILY INJURY OR DEATH. YOU ARE RESPONSIBLE FOR ASSEMBLING AND SECURING ALL FRONT RUNNER PRODUCTS TO YOUR VEHICLE. CHECKING THE ATTACHMENTS PRIOR TO USE, AND PERIODICALLY INSPECTING THE PRODUCTS FOR ADJUSTMENT, WEAR AND DAMAGE. THEREFORE YOU MUST READ AND UNDERSTAND ALL OF THE INSTRUCTIONS AND PRECAUTIONS SUPPLIED WITH YOUR FRONT RUNNER PRODUCT PRIOR TO INSTALLATION OR USE. IF YOU DO NOT UNDERSTAND ALL OF THE INSTRUCTIONS AND CAUTIONS, OR IF YOU HAVE NO MECHANICAL EXPERIENCE AND ARE NOT THOROUGHLY FAMILIAR WITH THE INSTALLATION PROCEDURES, YOU SHOULD HAVE THE PRODUCT INSTALLED BY A PROFESSIONAL INSTALLER OR OTHER QUALIFIED PERSONNEL.

1

# GET ORGANIZED

## IN THE BOX

1	1 X	Ladder
2	1 X	Z-Clamp
3	1 X	Foam Rubber 600mm Long

## TOOLS NEEDED



FIGURE 1.1

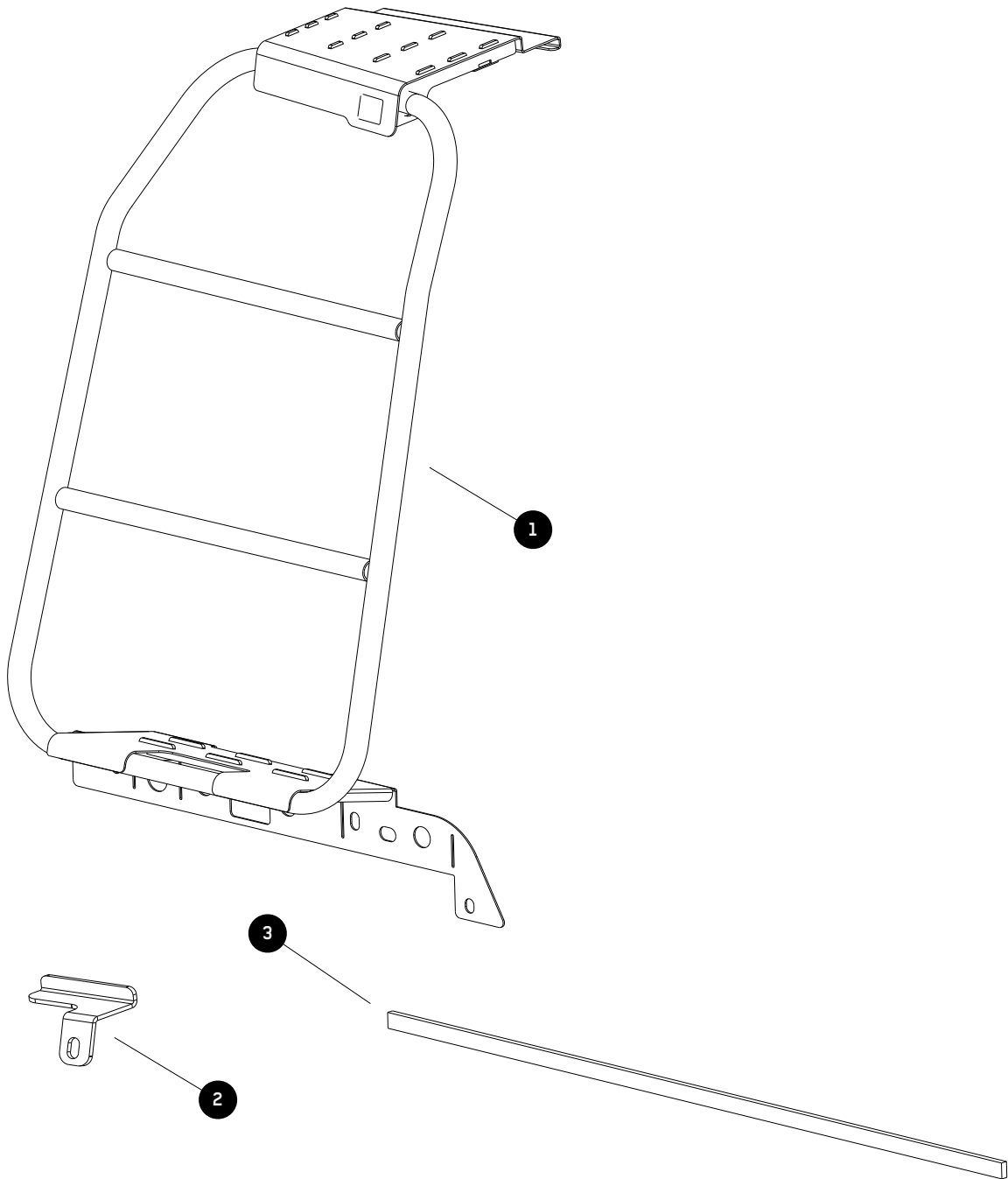

**2**

**PREPARE FOR LADDER FITMENT**

2.1

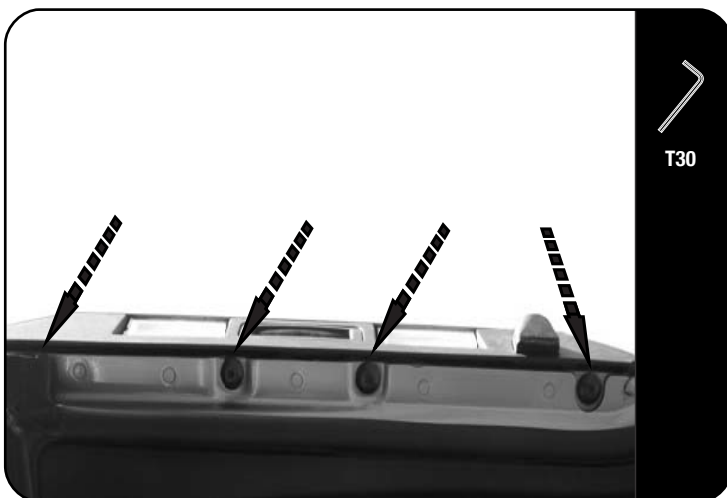

Open the top rear door and remove the four Torx Bolts (T30) as indicated by the arrows. You will need to lift the rubber door seal in order to remove the far left Torx Bolt.



2.2



Remove the screw inside the door handle.



2.3



Remove the trim around the door striker.



**2**

**PREPARE FOR LADDER FITMENT**

2.4



Remove the interior trim panel by pulling it away from the vehicle's body. Take care not to damage any of the plastic retaining clips.

2.5

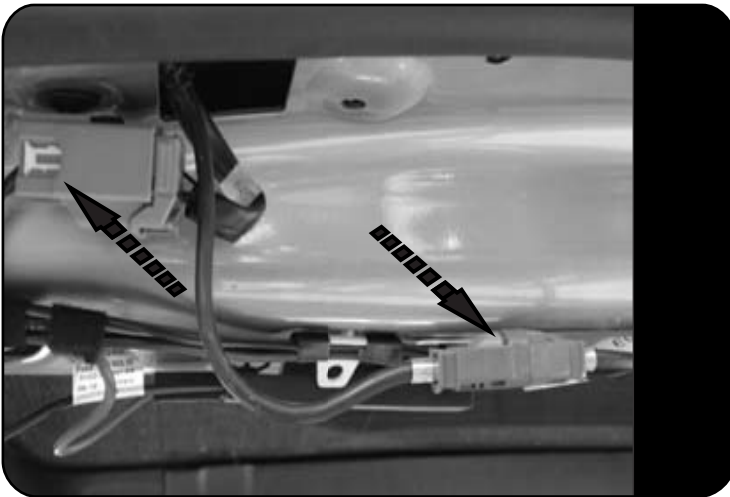

Disconnect the electrical connector as indicated (Including rear camera if fitted).

2.6

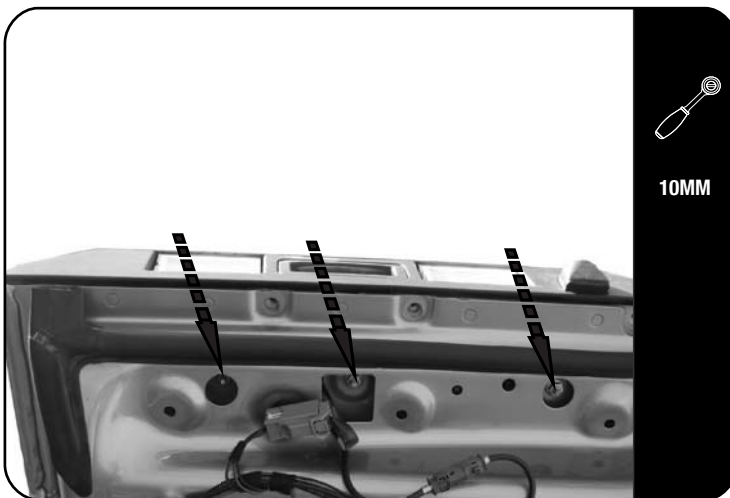

Loosen and remove the three hex nuts shown.

## 2 PREPARE FOR LADDER FITMENT

2.7

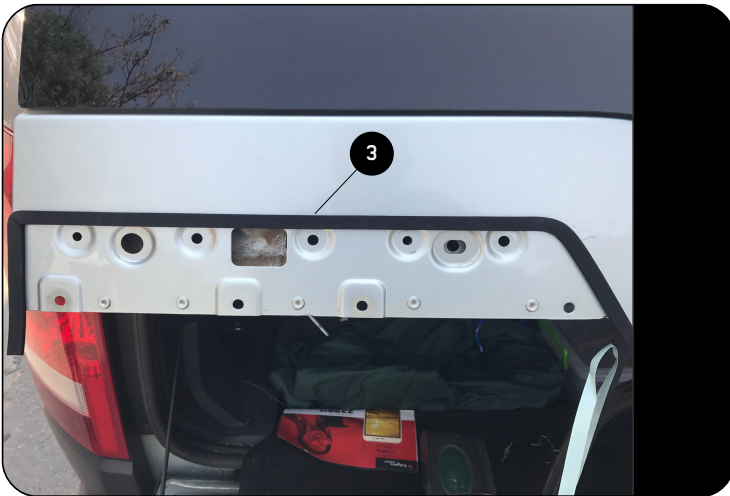

Remove the rear number plate light cluster from the vehicle.

Before removing the protective backing on the Foam Rubber (Item 3) make sure that the surface where it will be adhered is clean.

Follow the outer line of the number plate light cluster and adhere the Foam Rubber accordingly. See Step 2.7.

Open the bottom rear door and close the top rear door, so as to not accidentally lock the rear door.

## 3 LADDER FITMENT

3.1

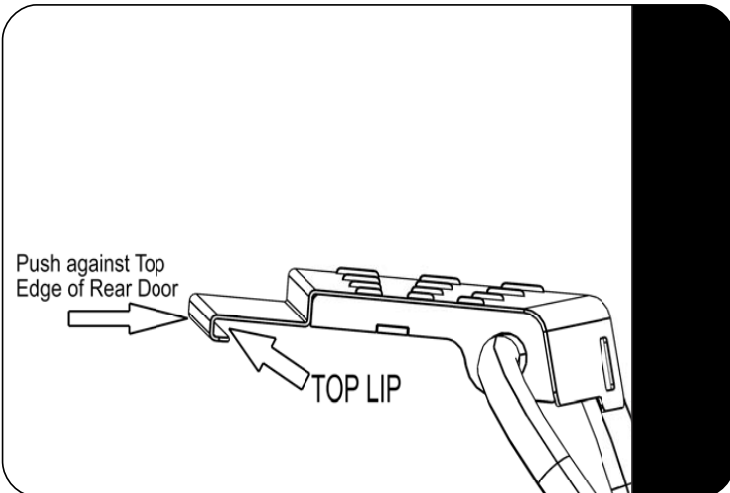

Hook the lip at the top of the Ladder over the top edge of the Rear Door through the gap between the door and the vehicle's roof. See Step 3.2.

Push the top lip against the top edge of the rear door.

3.2

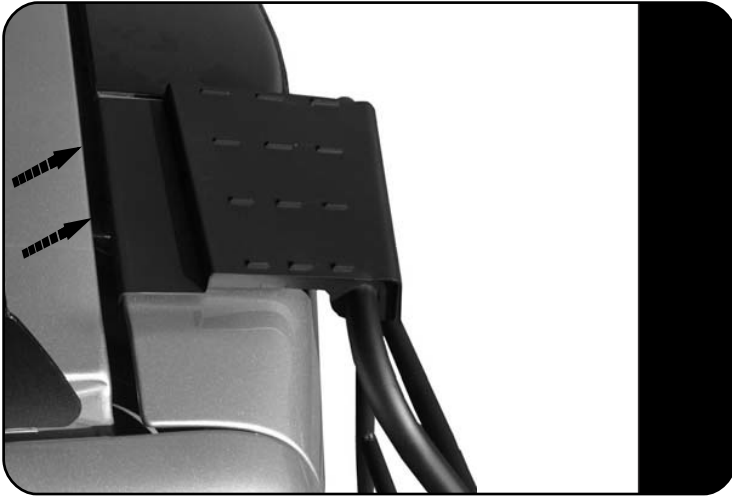

3.3



Align the holes in the bottom of the Ladder with the holes in the vehicle's body (behind the rear number plate light cluster removed earlier).

Place the rear number plate light cluster over the bottom of the Ladder and secure using the hex nuts removed in Step 2.6.

3.4

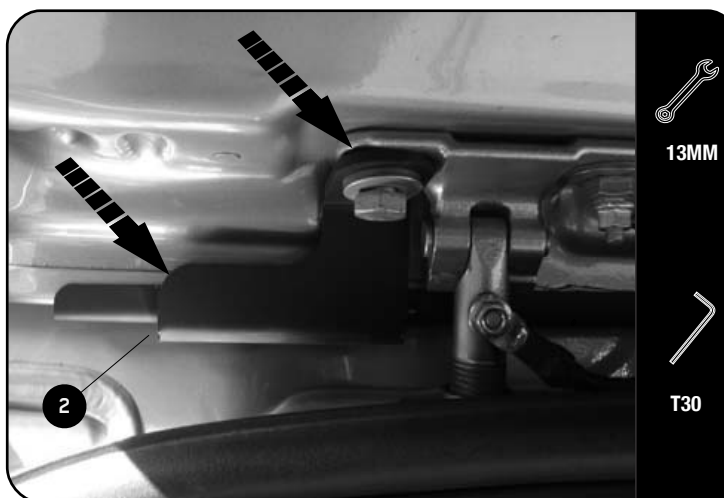

Open the top rear door and remove the outer hex bolt on the rear left hand side door hinge.

Ensure the top lip from the Ladder is against the top edge of the rear door (Refer to Step 3.1), Place the Z-Clamp (Item 2) over the top lip, lining up the hole in the Z-Clamp with the bolt hole. Secure the Z-Clamp to the vehicle using the hex bolt removed.

Reconnect the electrical plugs removed in Step 2.5, Refit the trim removed in Steps 2.2 to 2.4 and fasten the torx bolts removed in Step 2.1.

4

## COMPLETION

4.1



Congratulations! You did it. Take a step back and admire your work!

5

## INSTALL OTHER VEHICLE AND RACK ACCESSORIES

Now's the time to visit your favorite Front Runner Dealer in person or Online.

Be sure to tag us. We love to see our gear in action! #FrontRunnerOutfitters #BornToRoam

Share your adventures on: 