

REV TENT

ASSEMBLY & FOLD DOWN INSTRUCTIONS

SKUS: 6TK3SP1, 6TK3SP2, 6TK3SP3, 6RT3ZP1

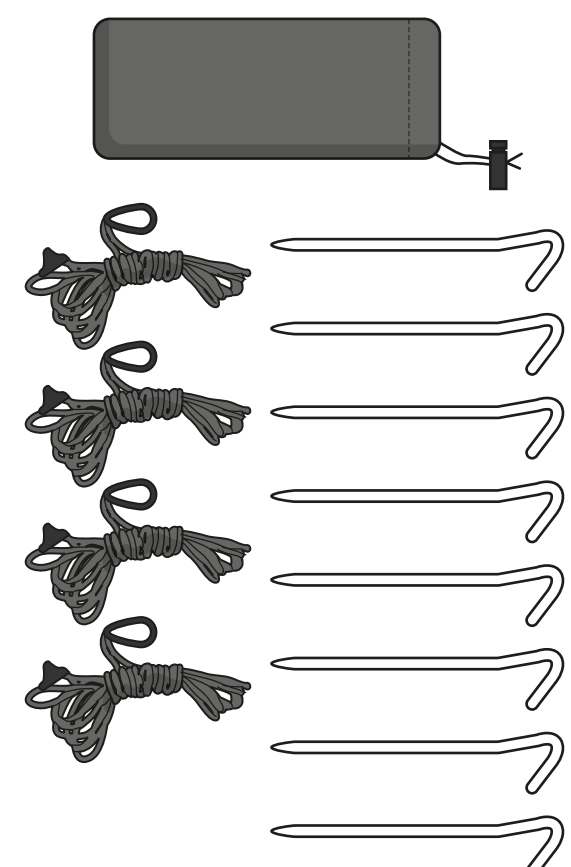

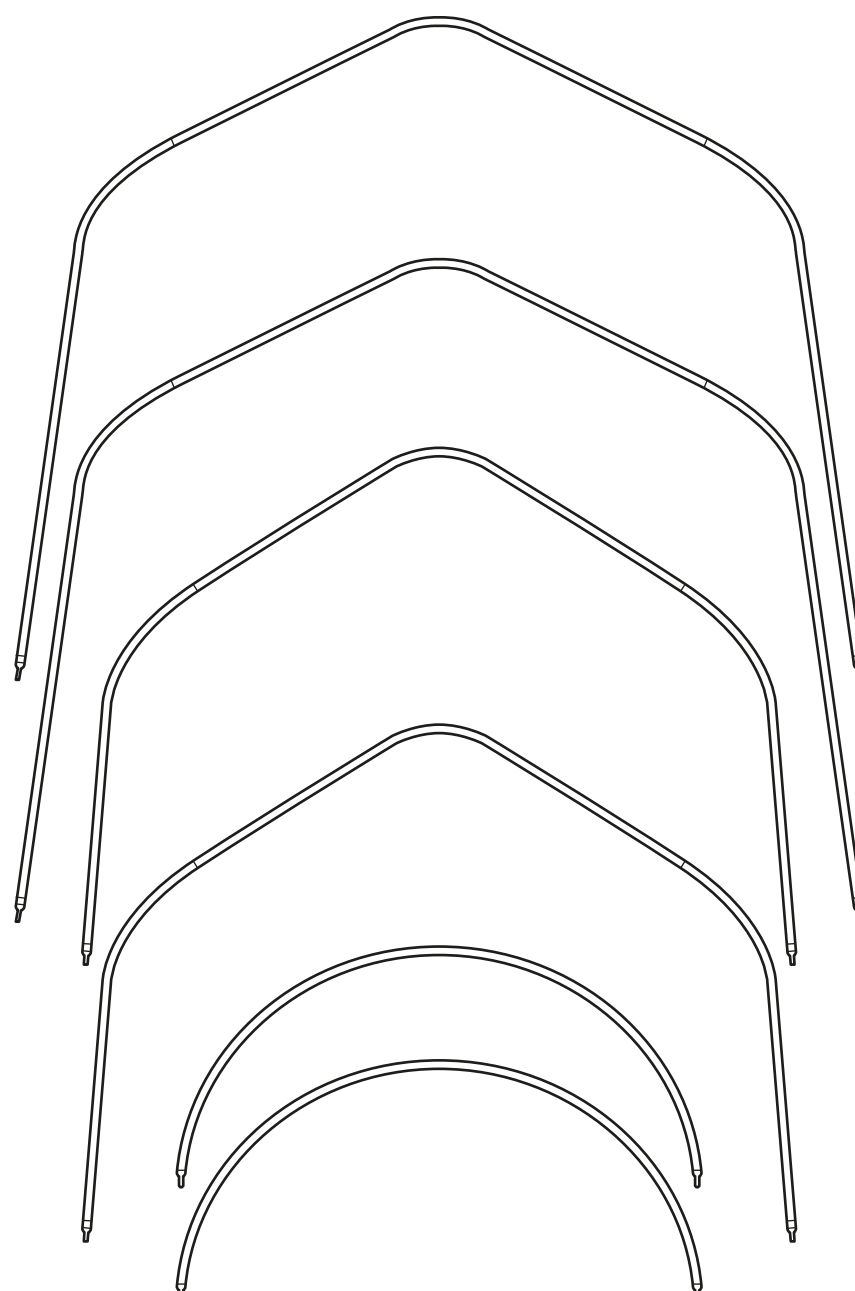
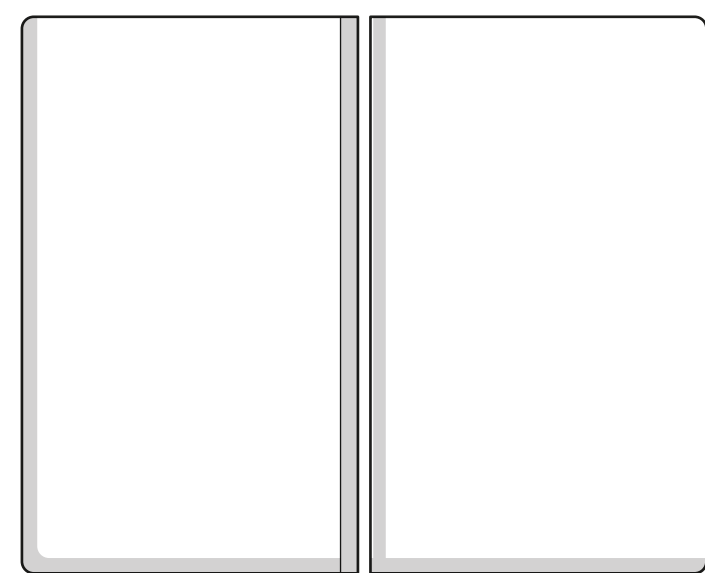
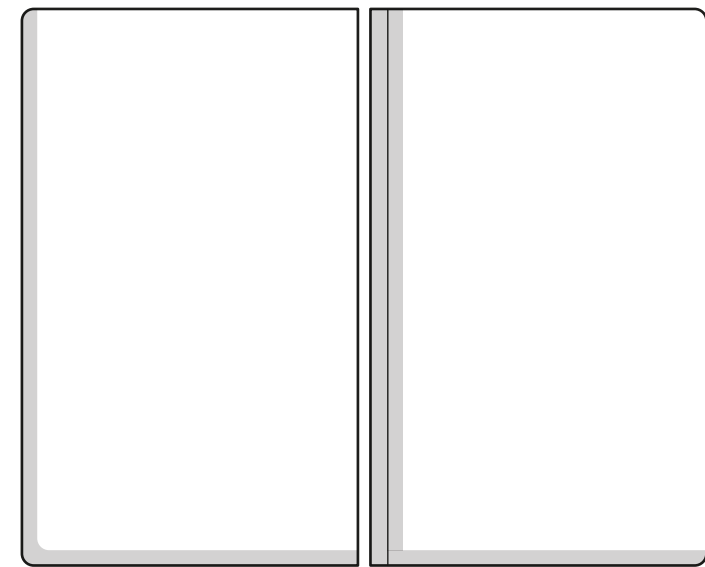
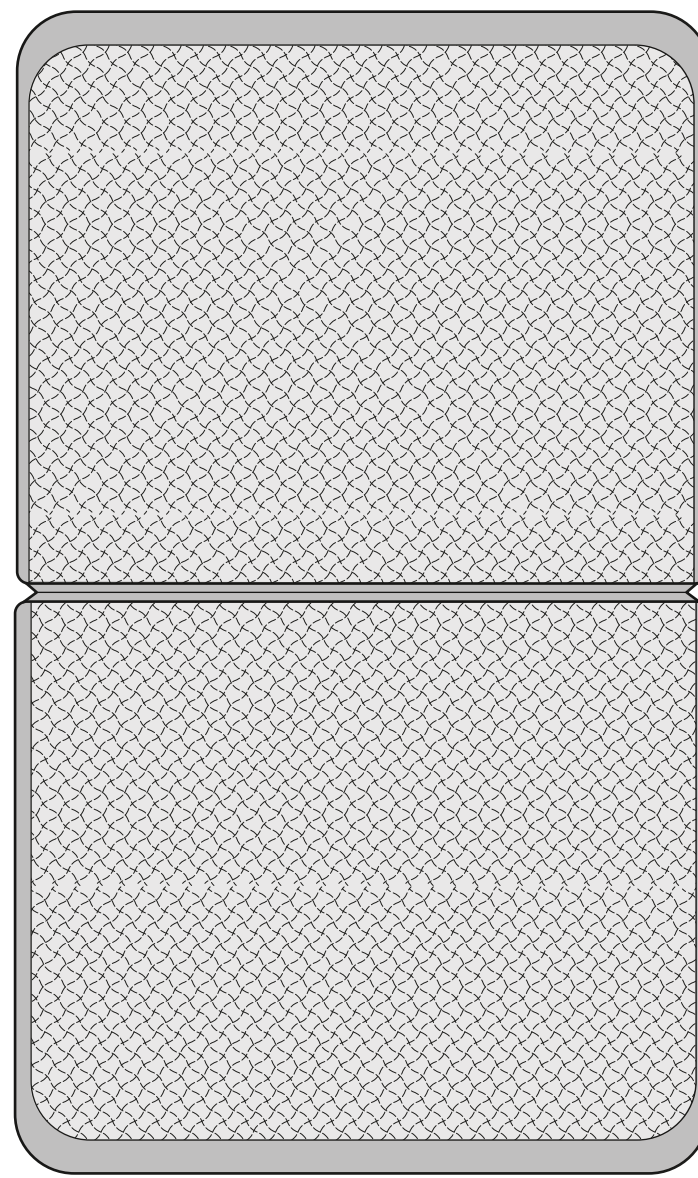
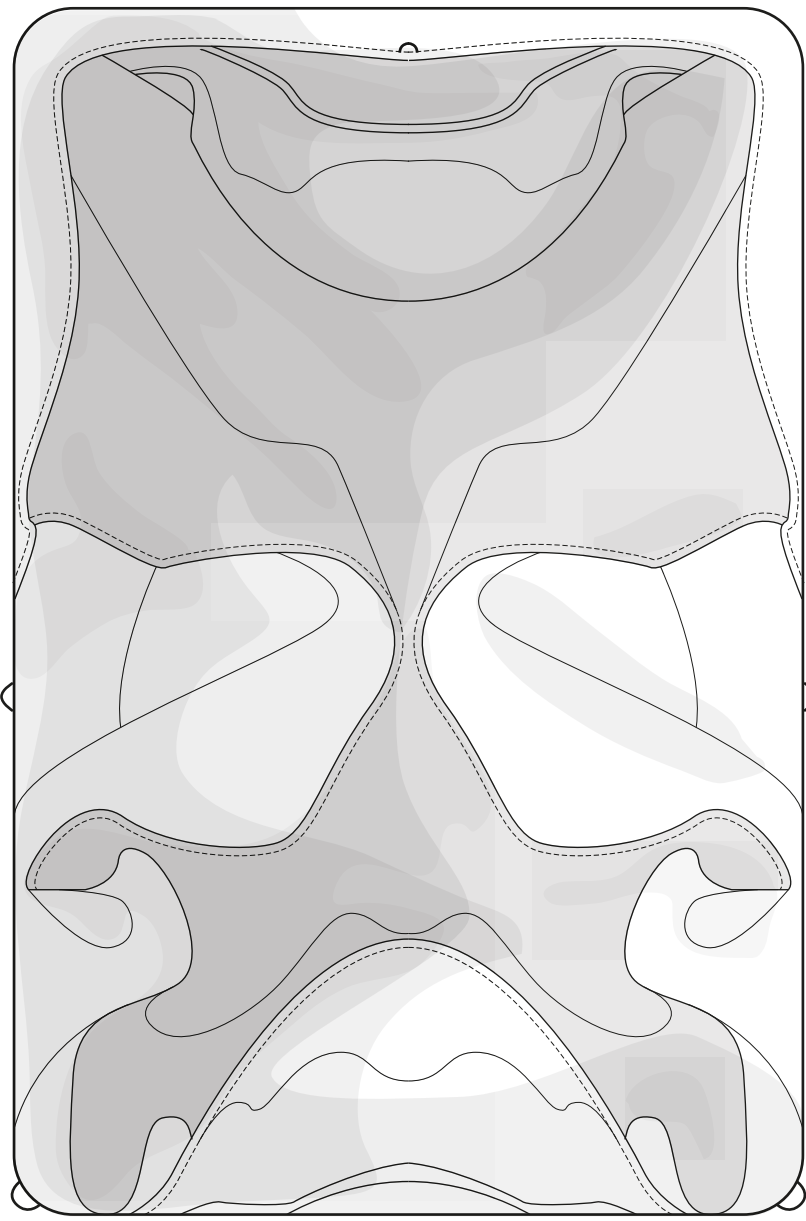
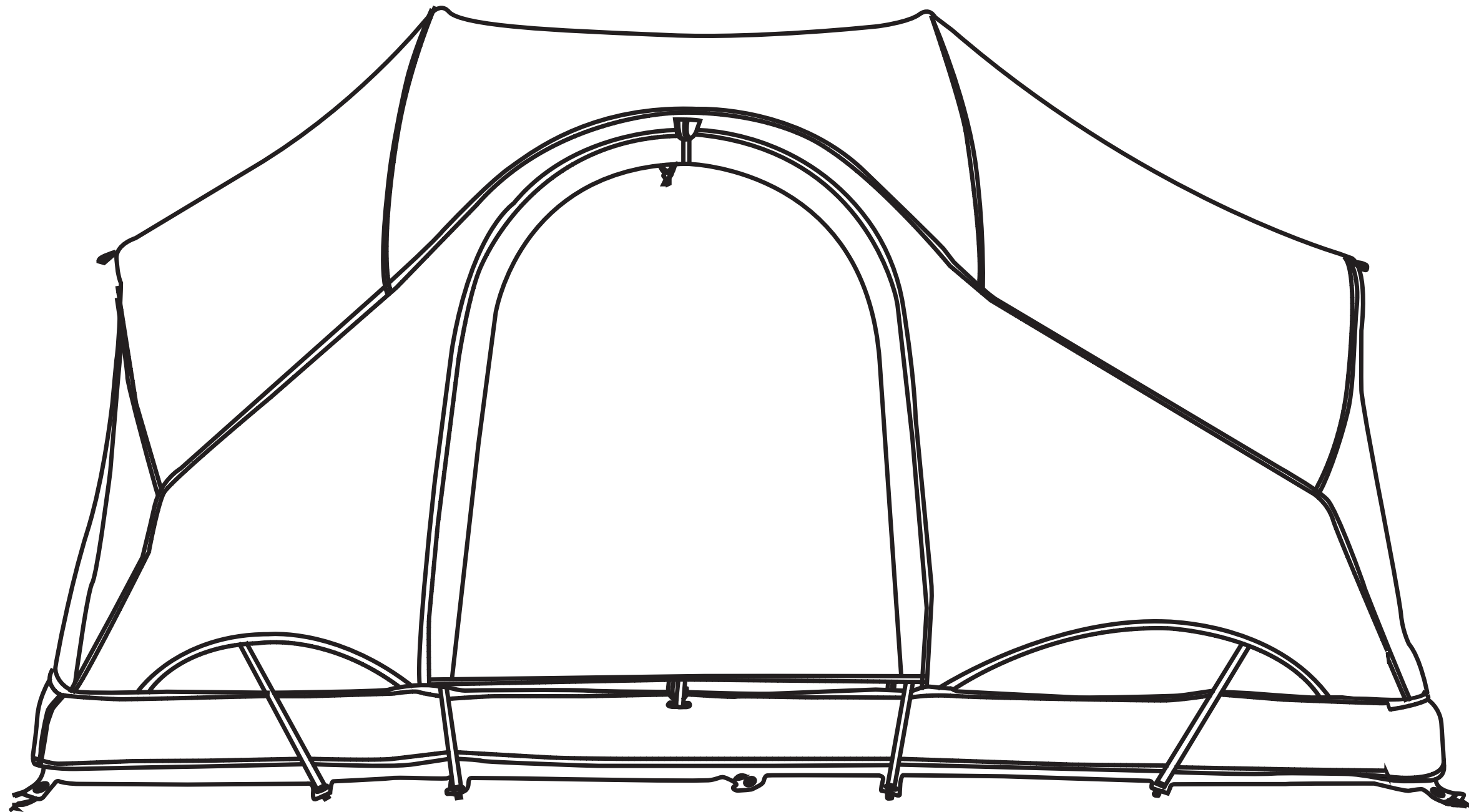
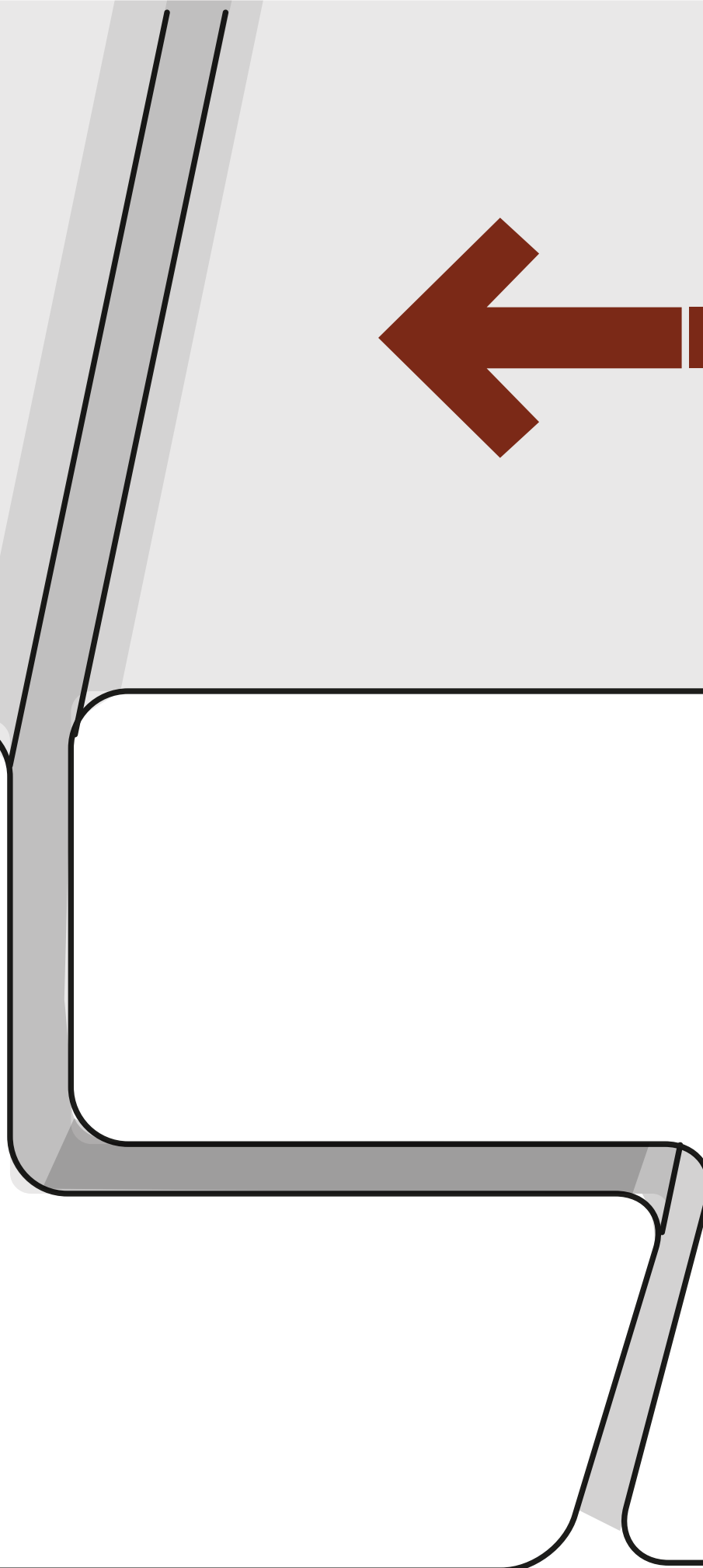
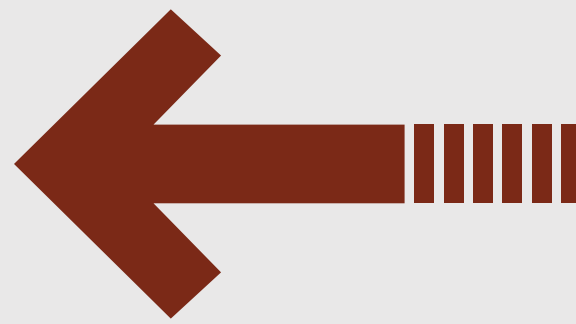
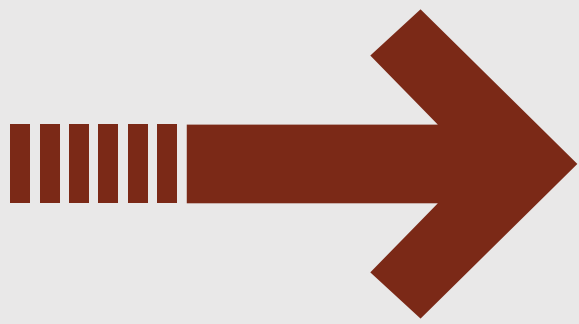
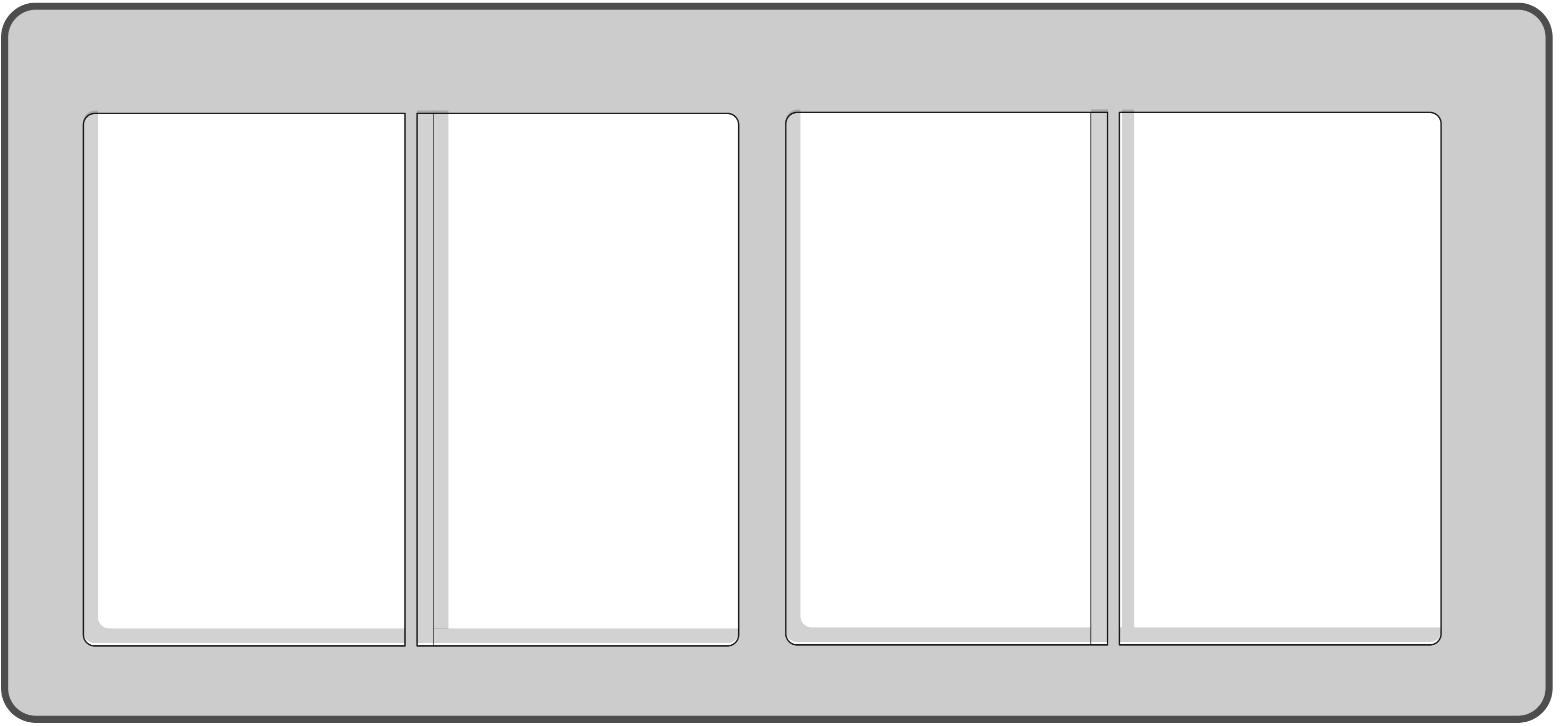

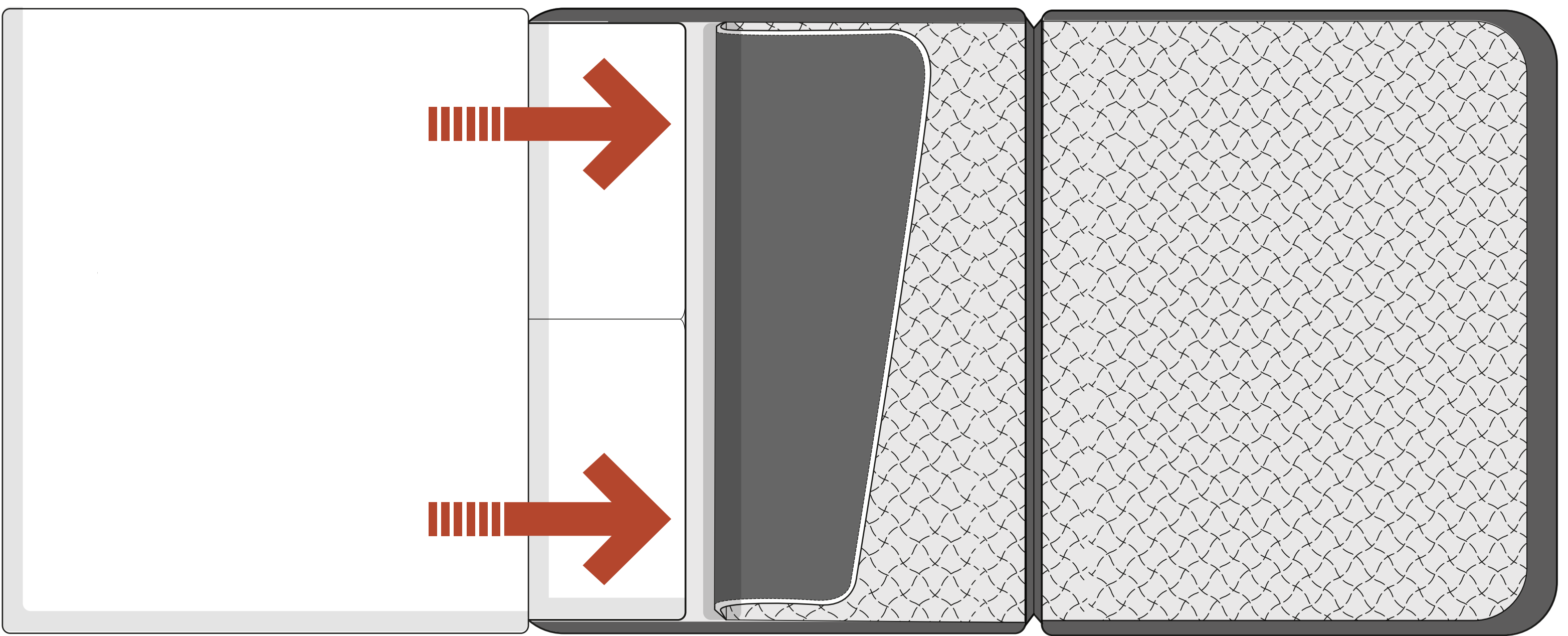
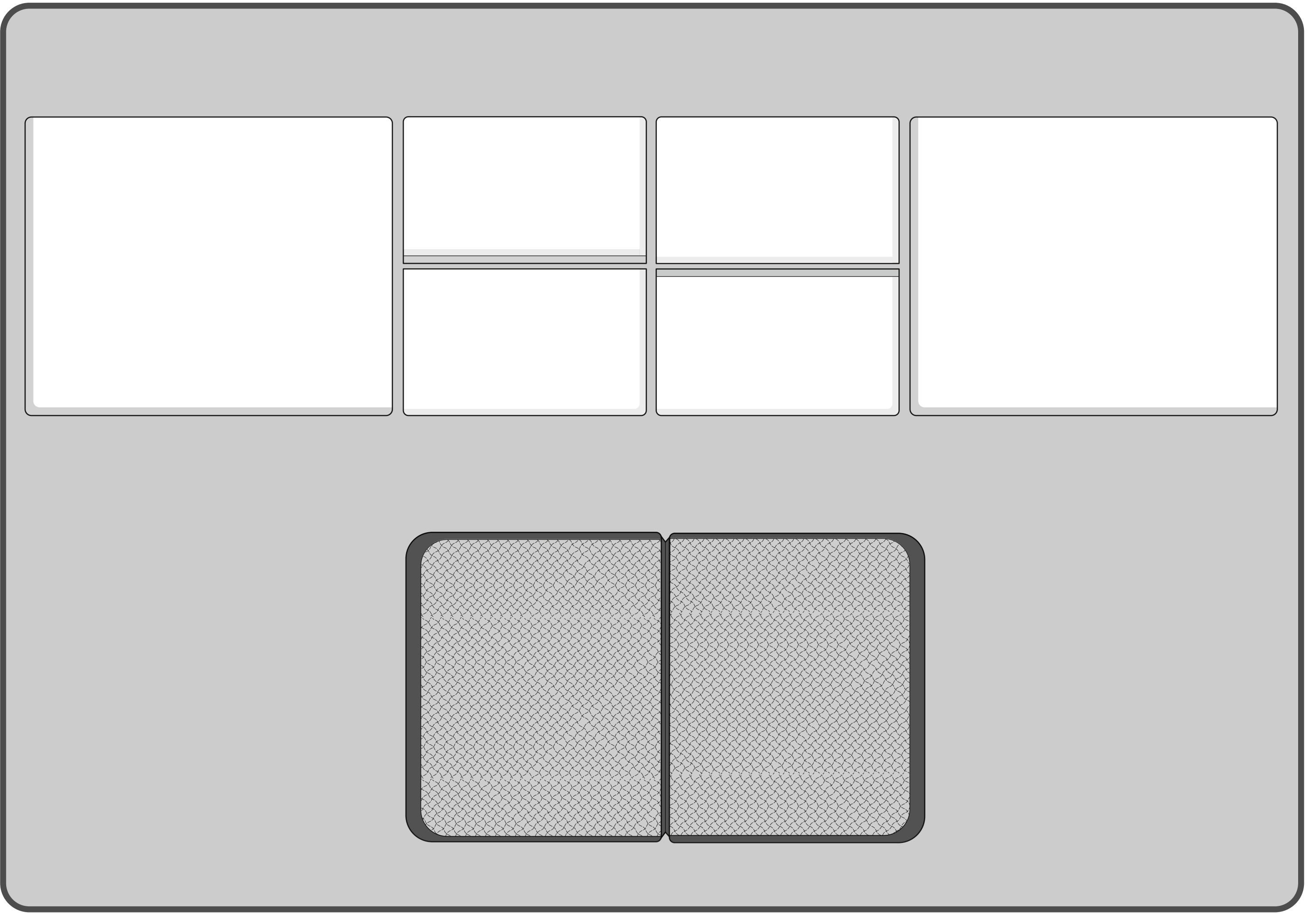

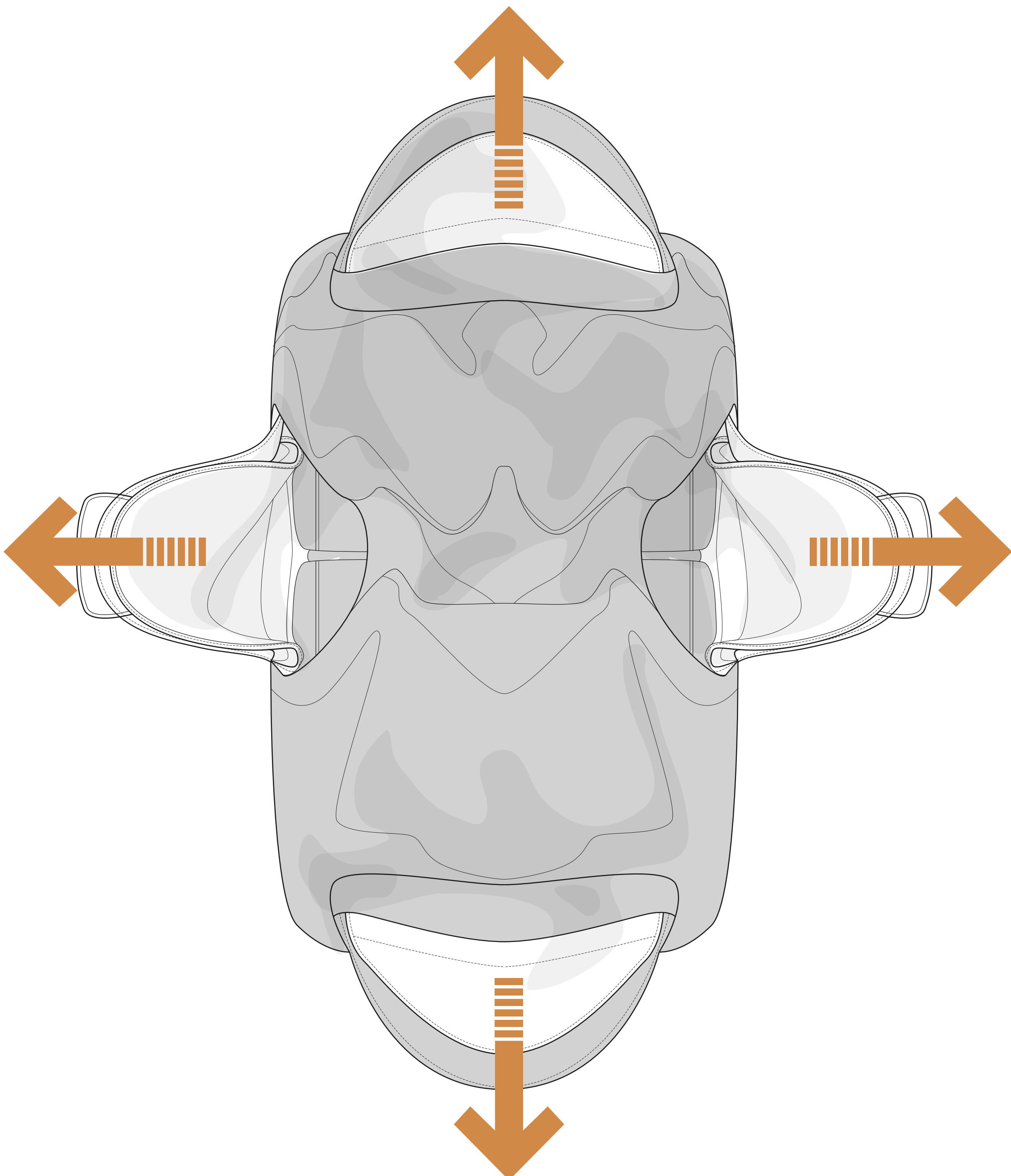
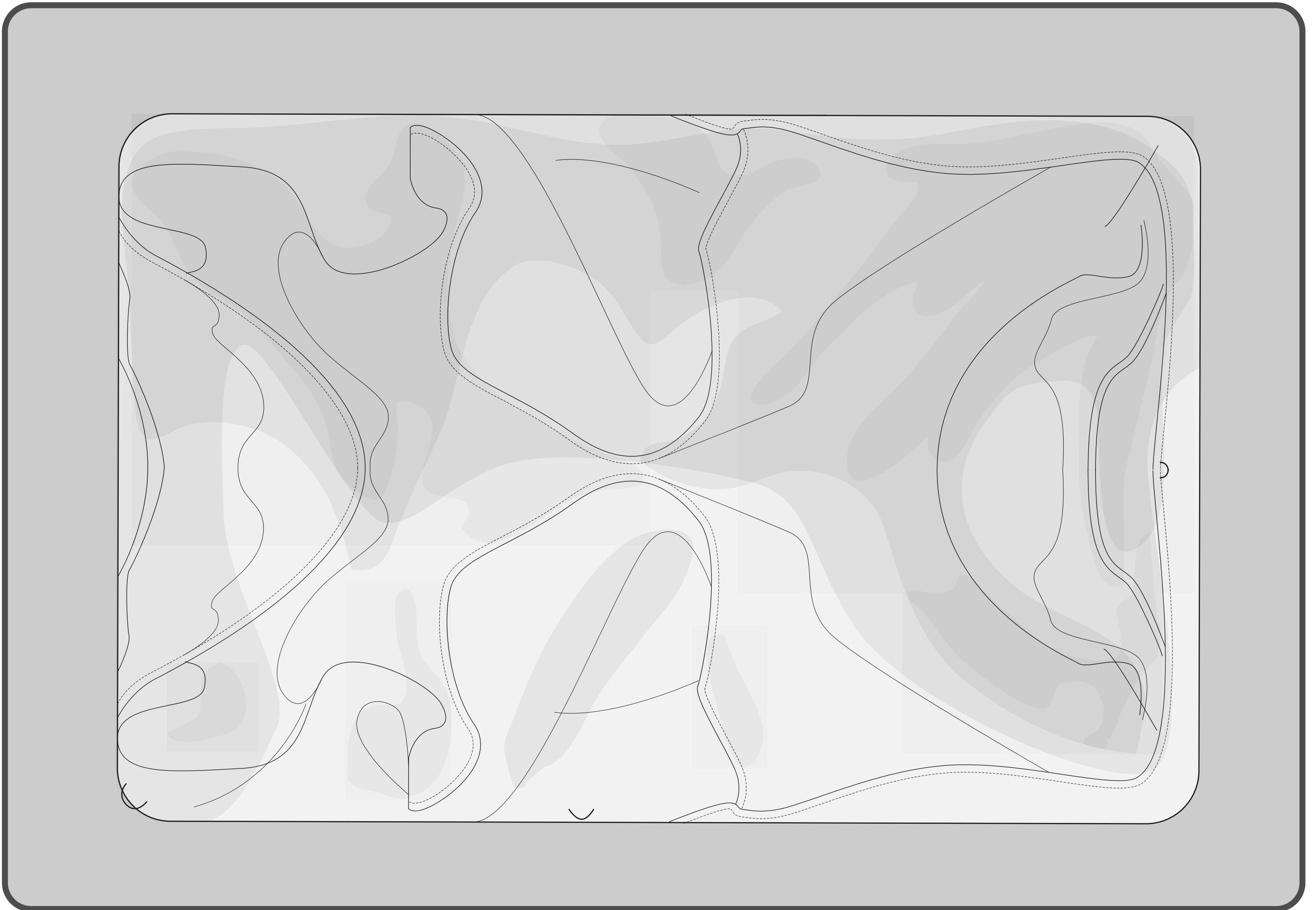
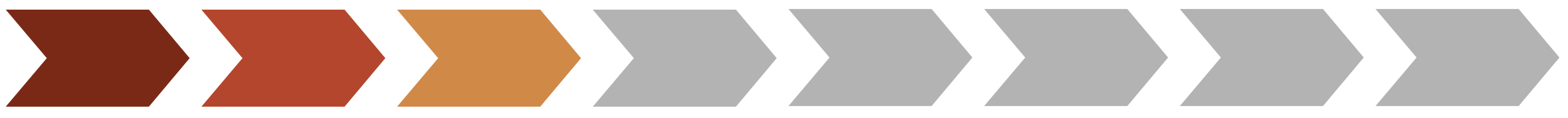

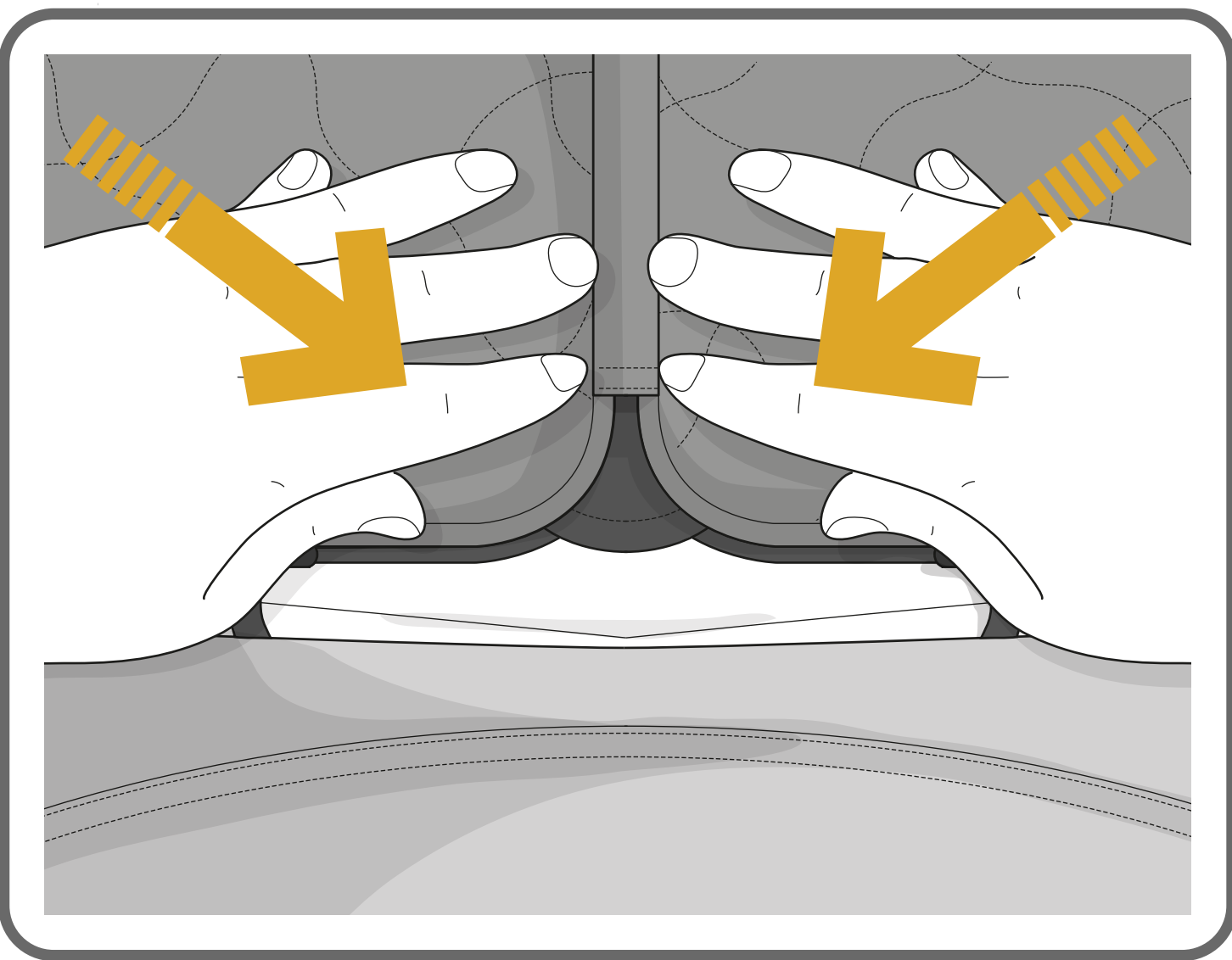
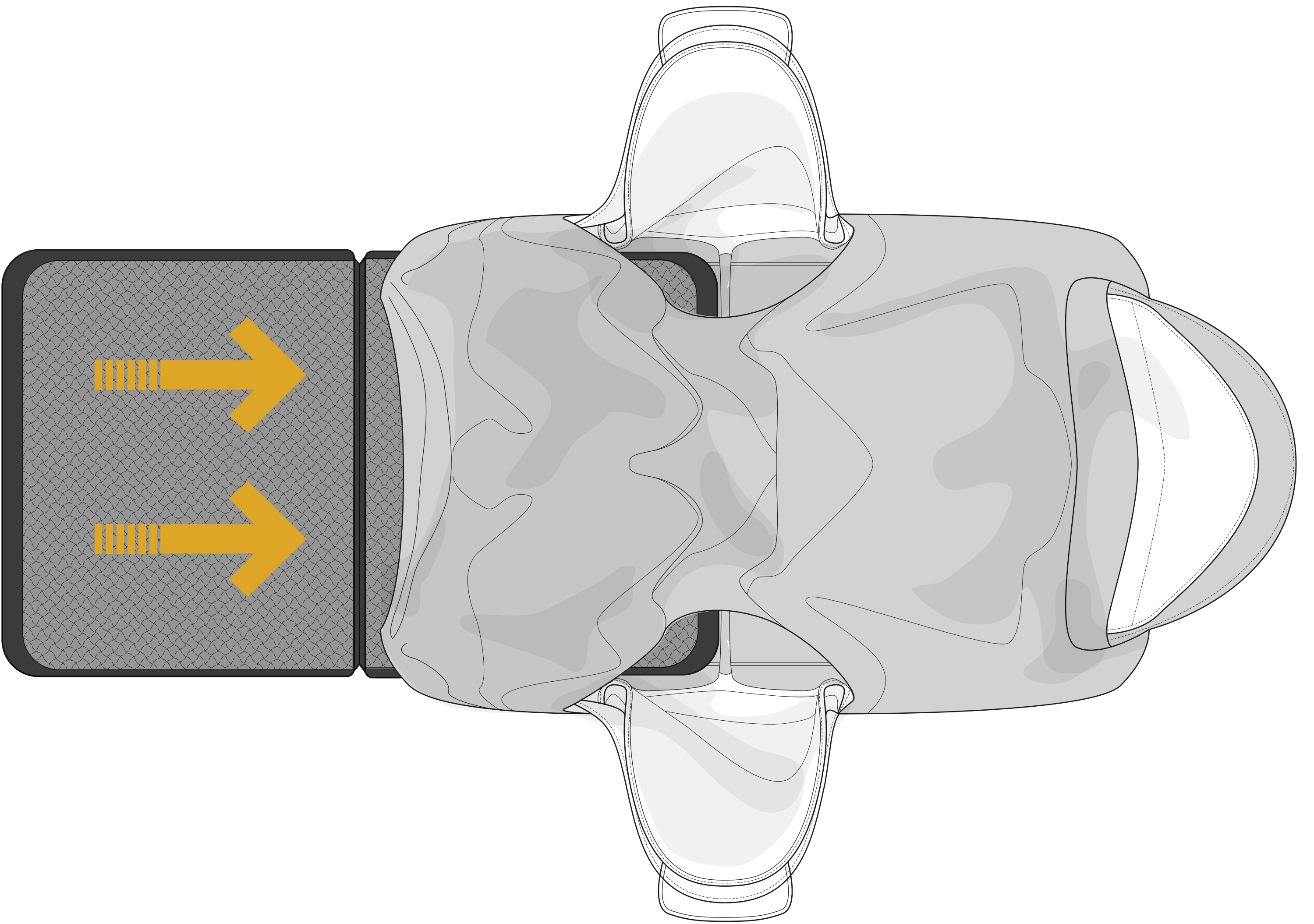
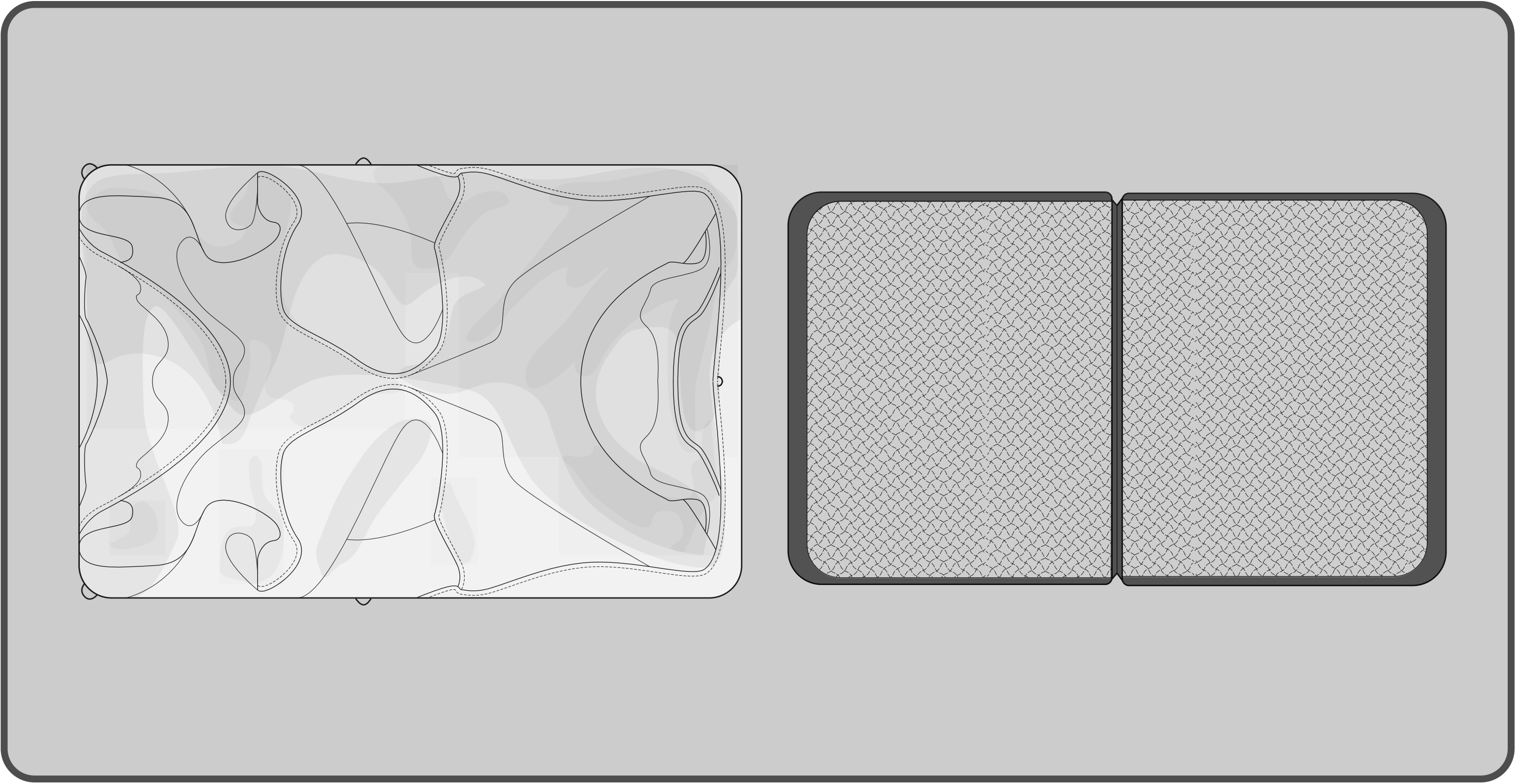

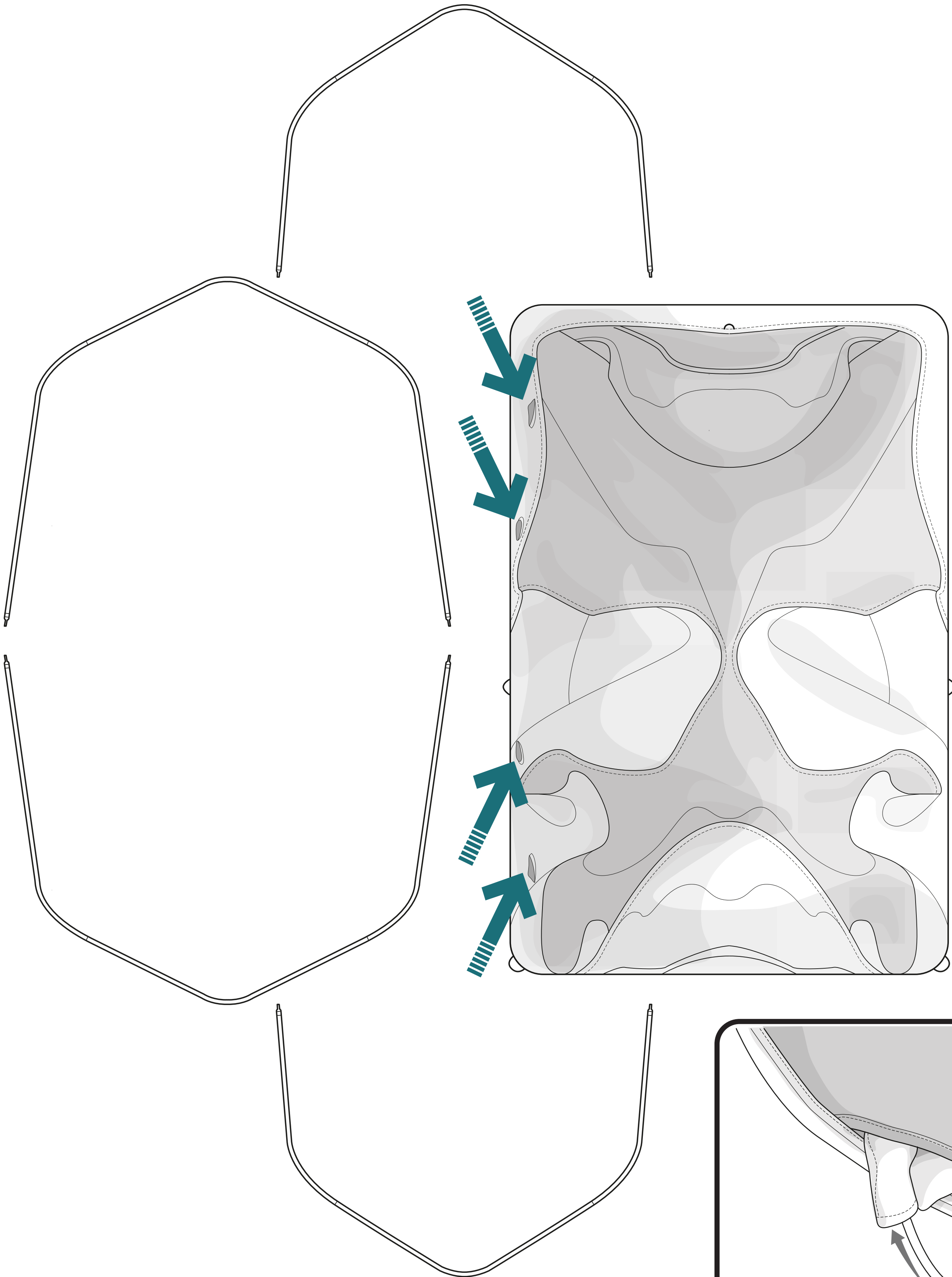
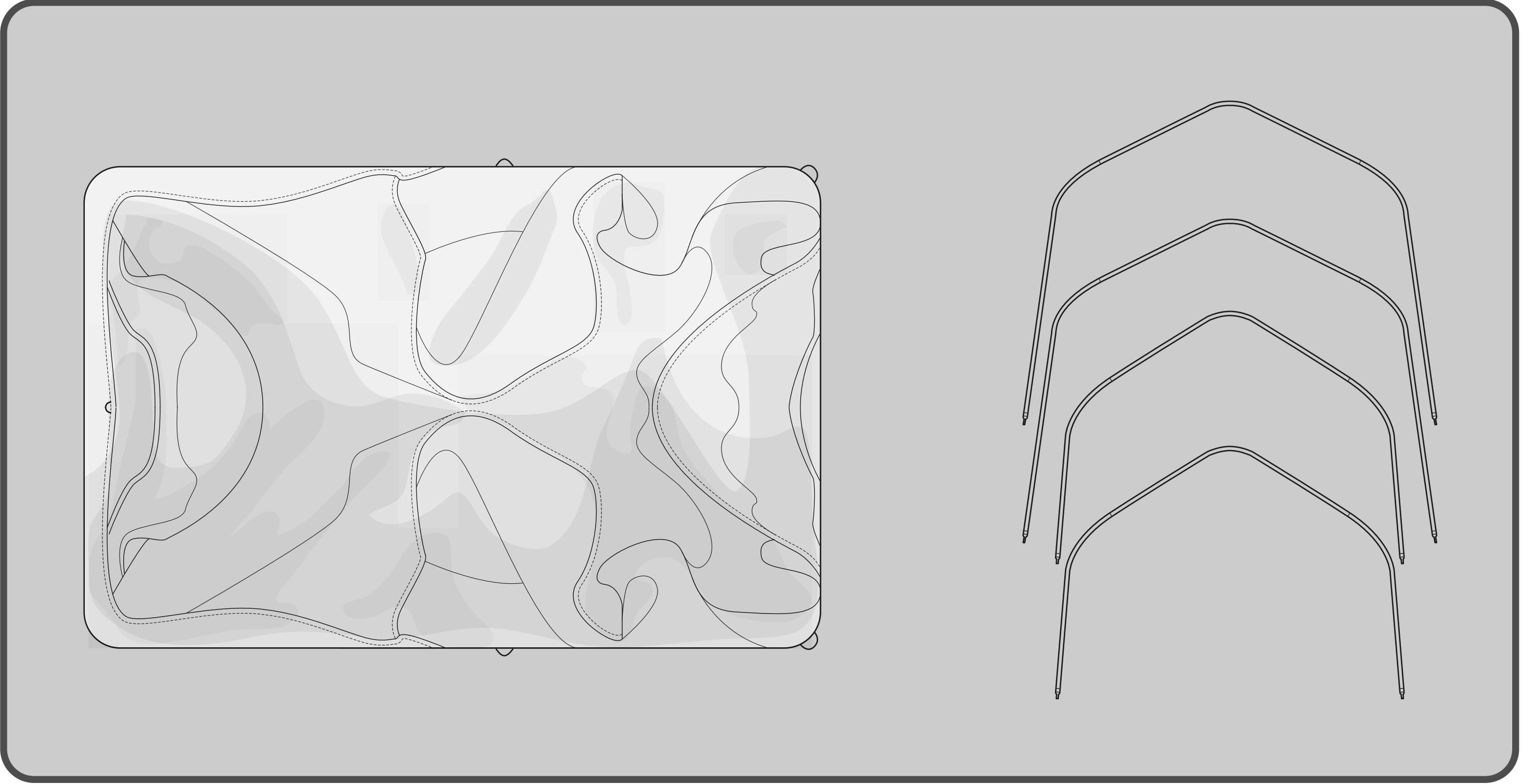

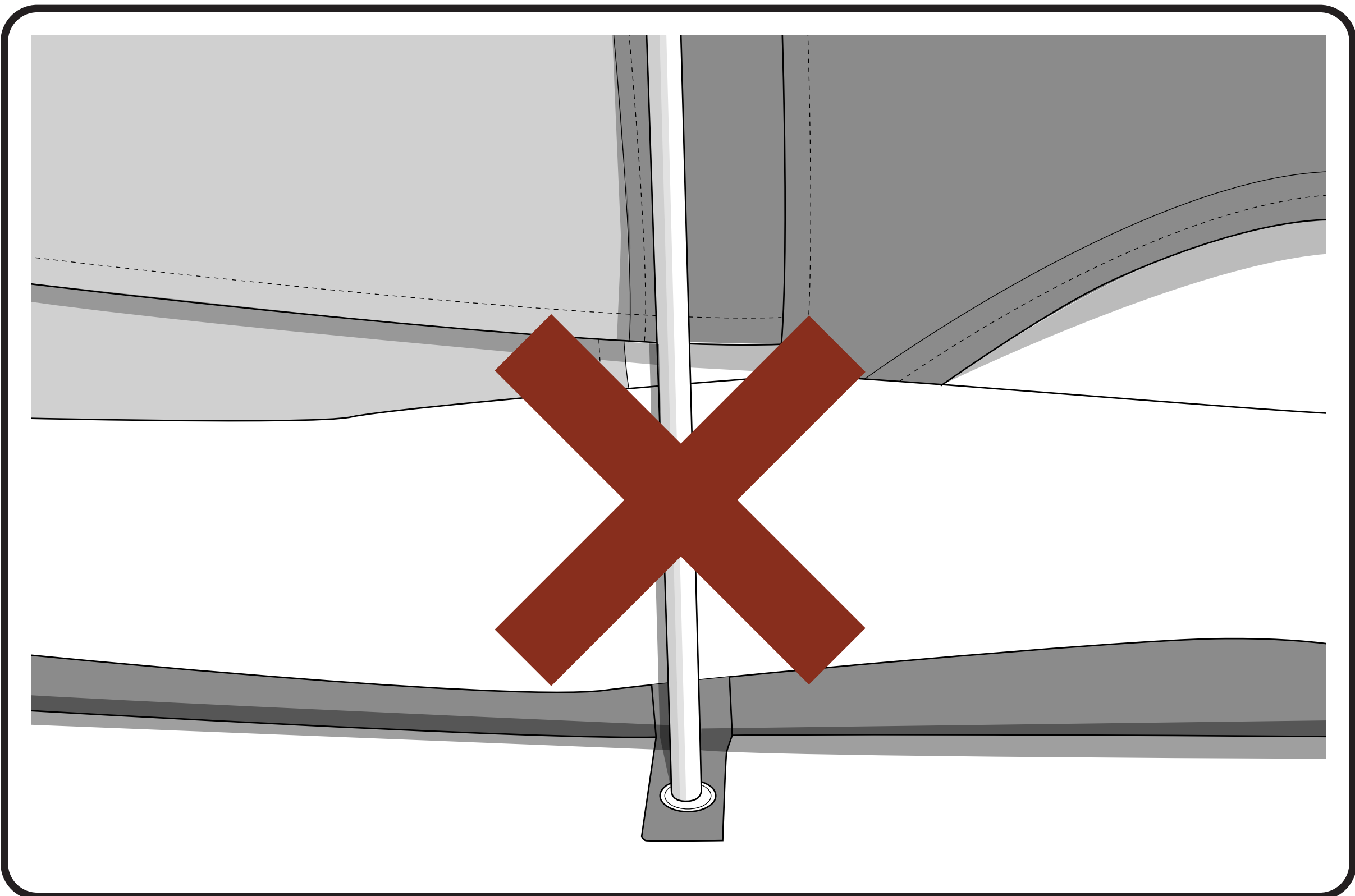
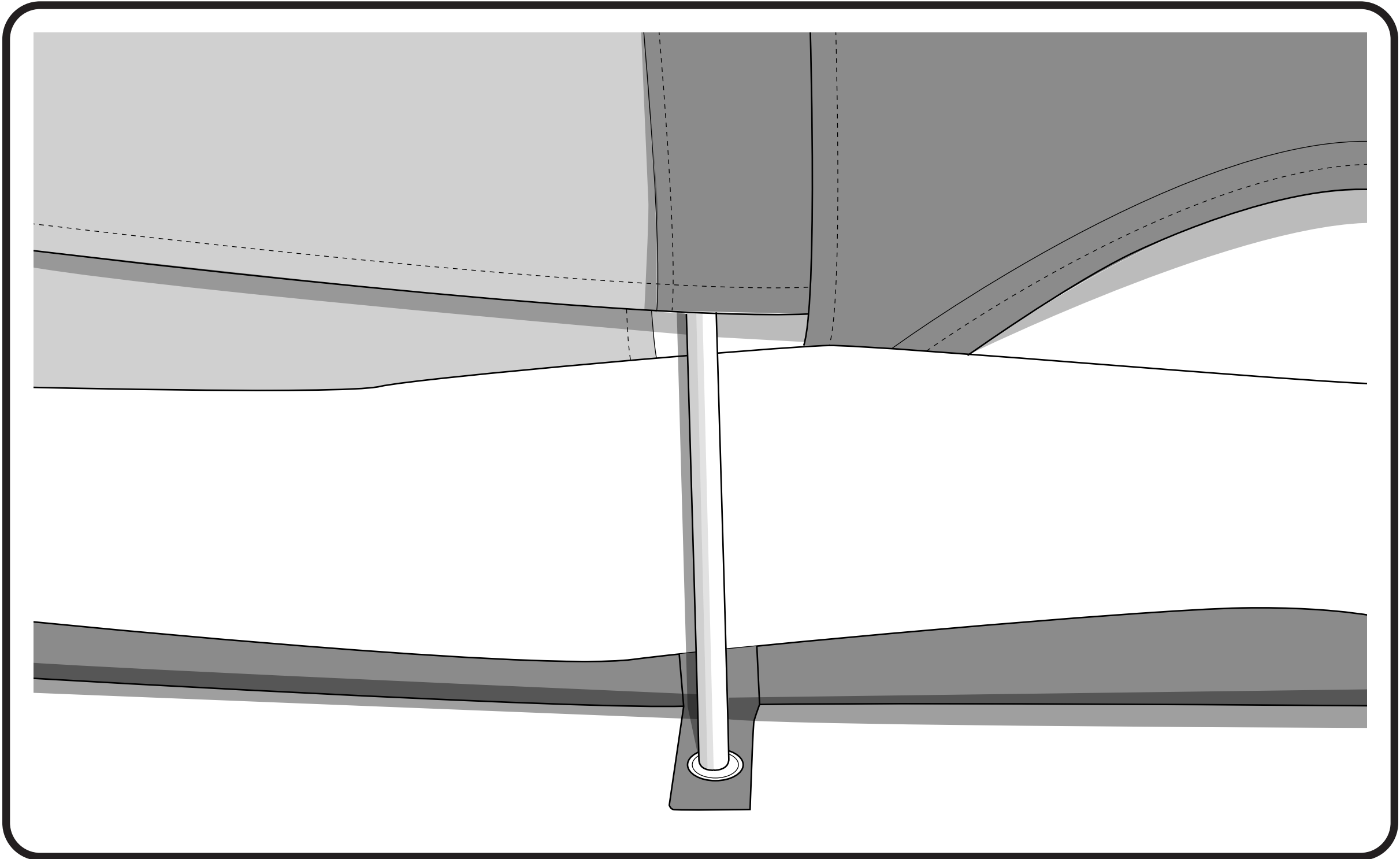
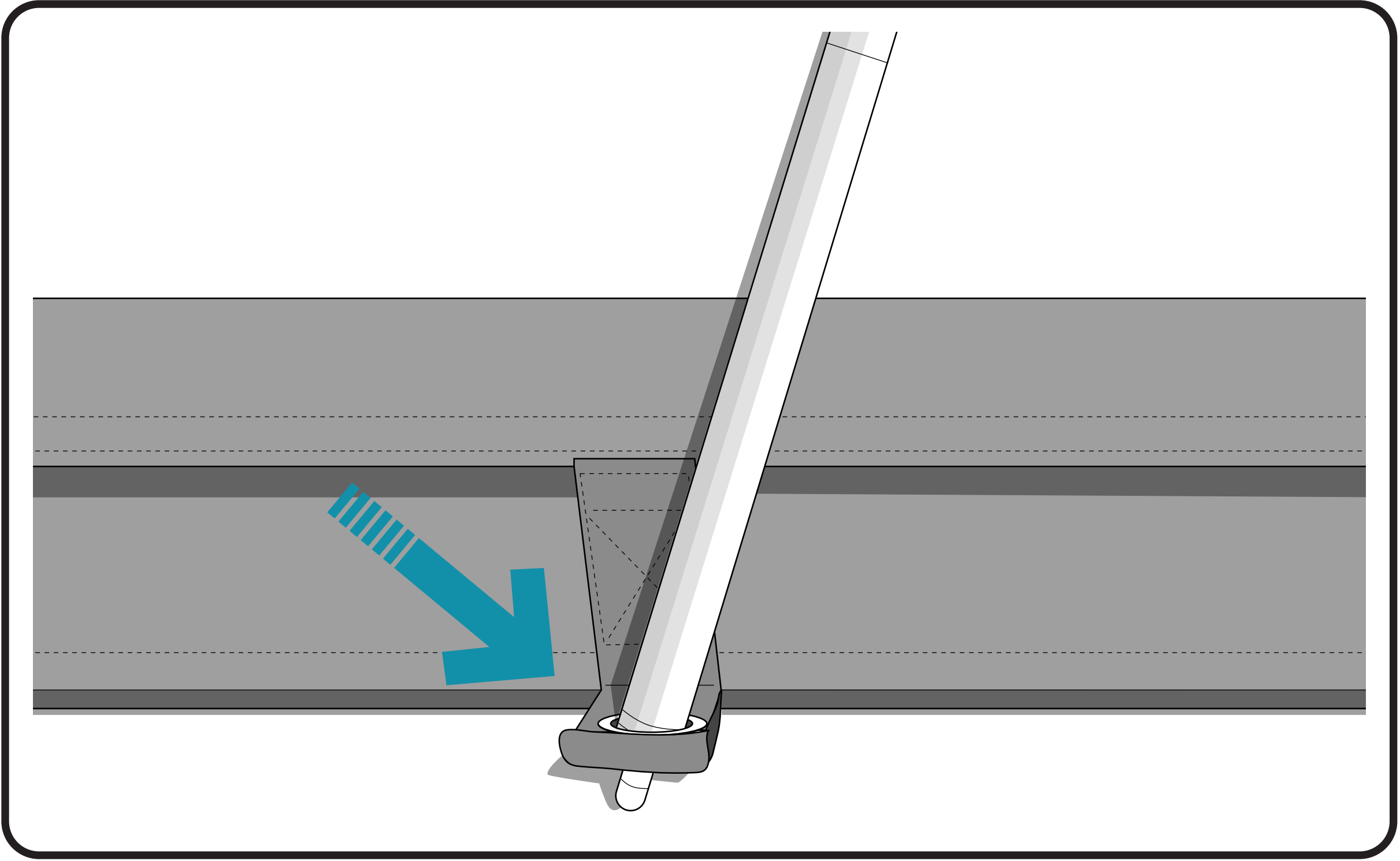

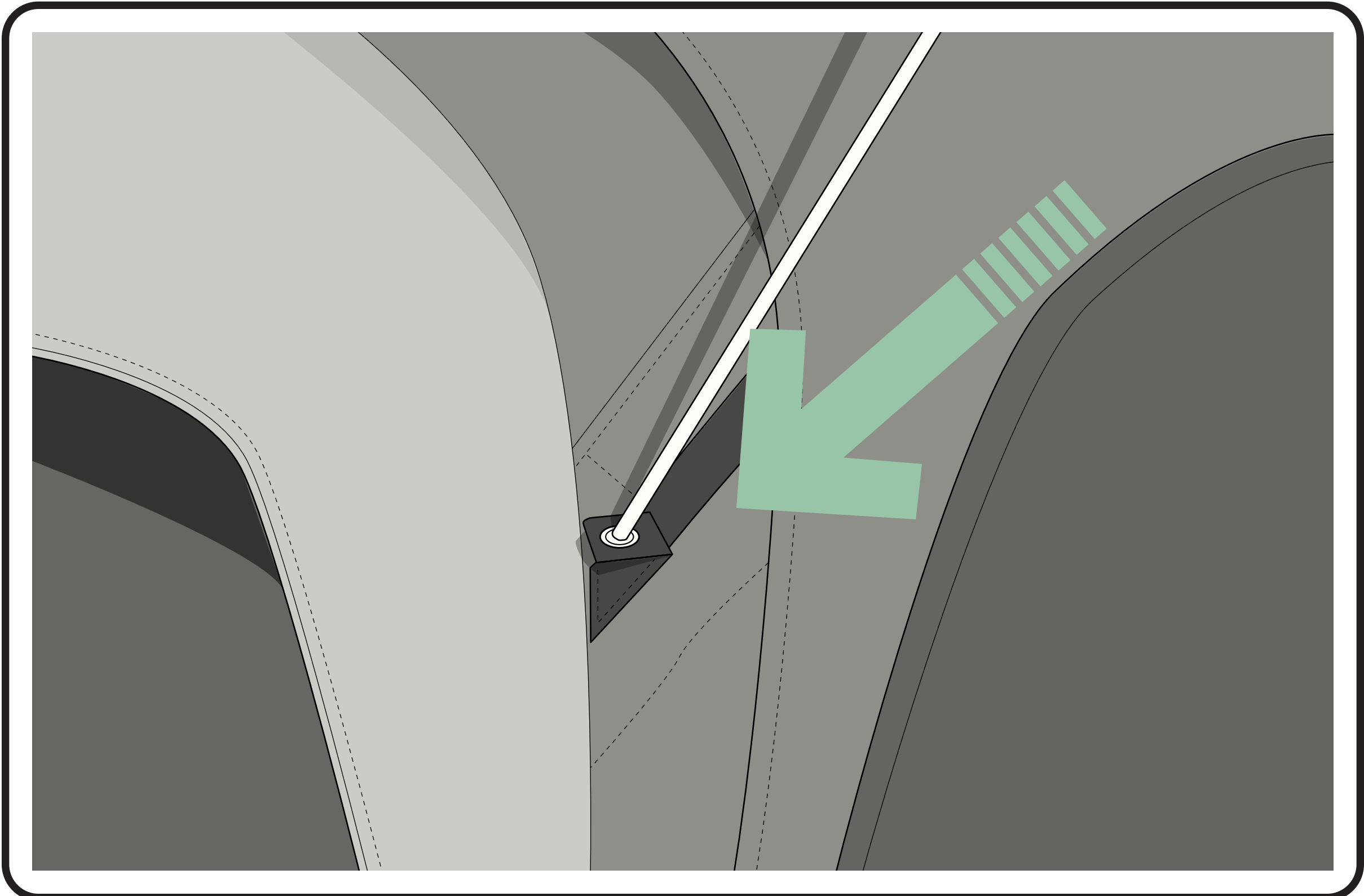
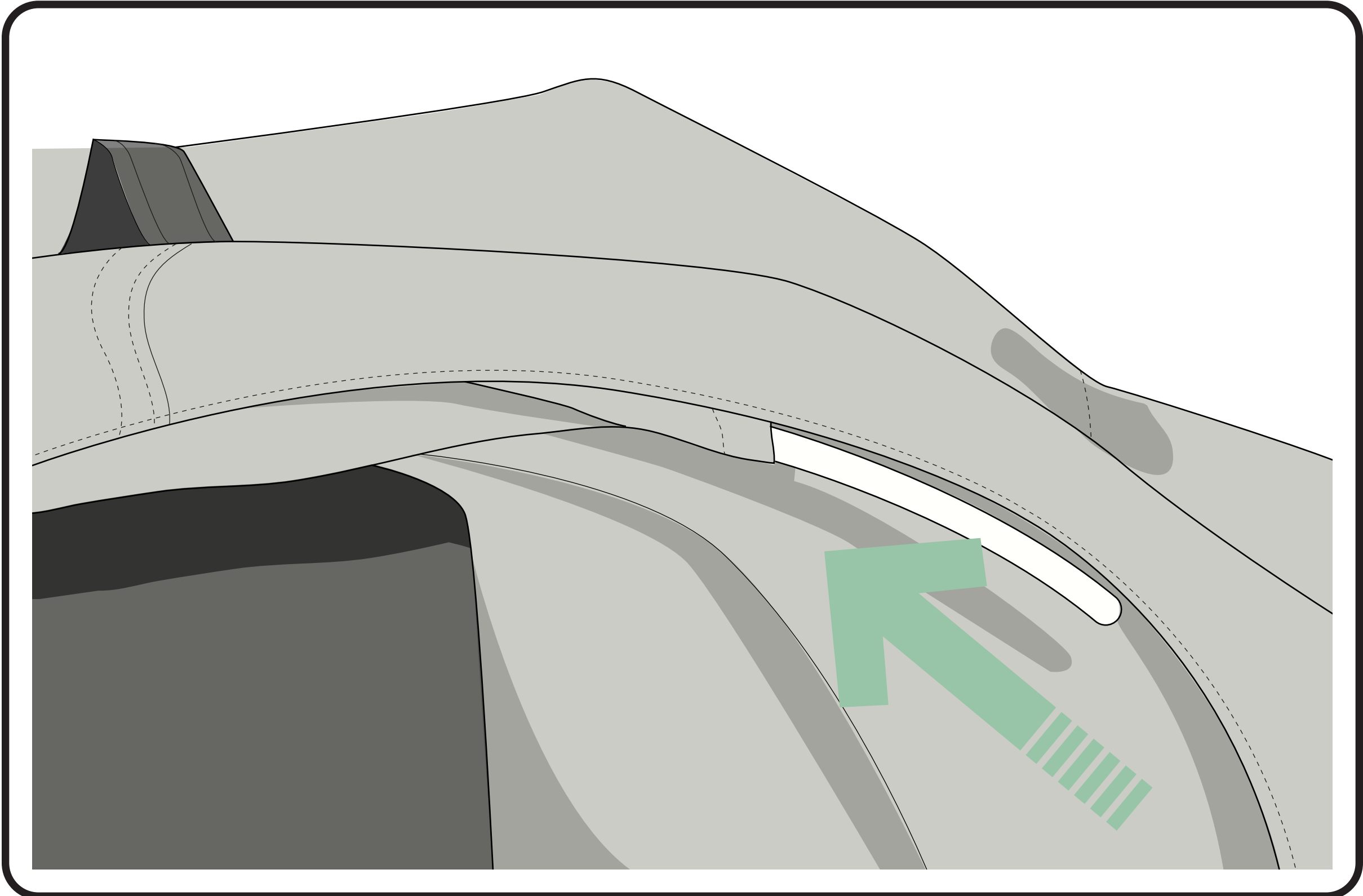
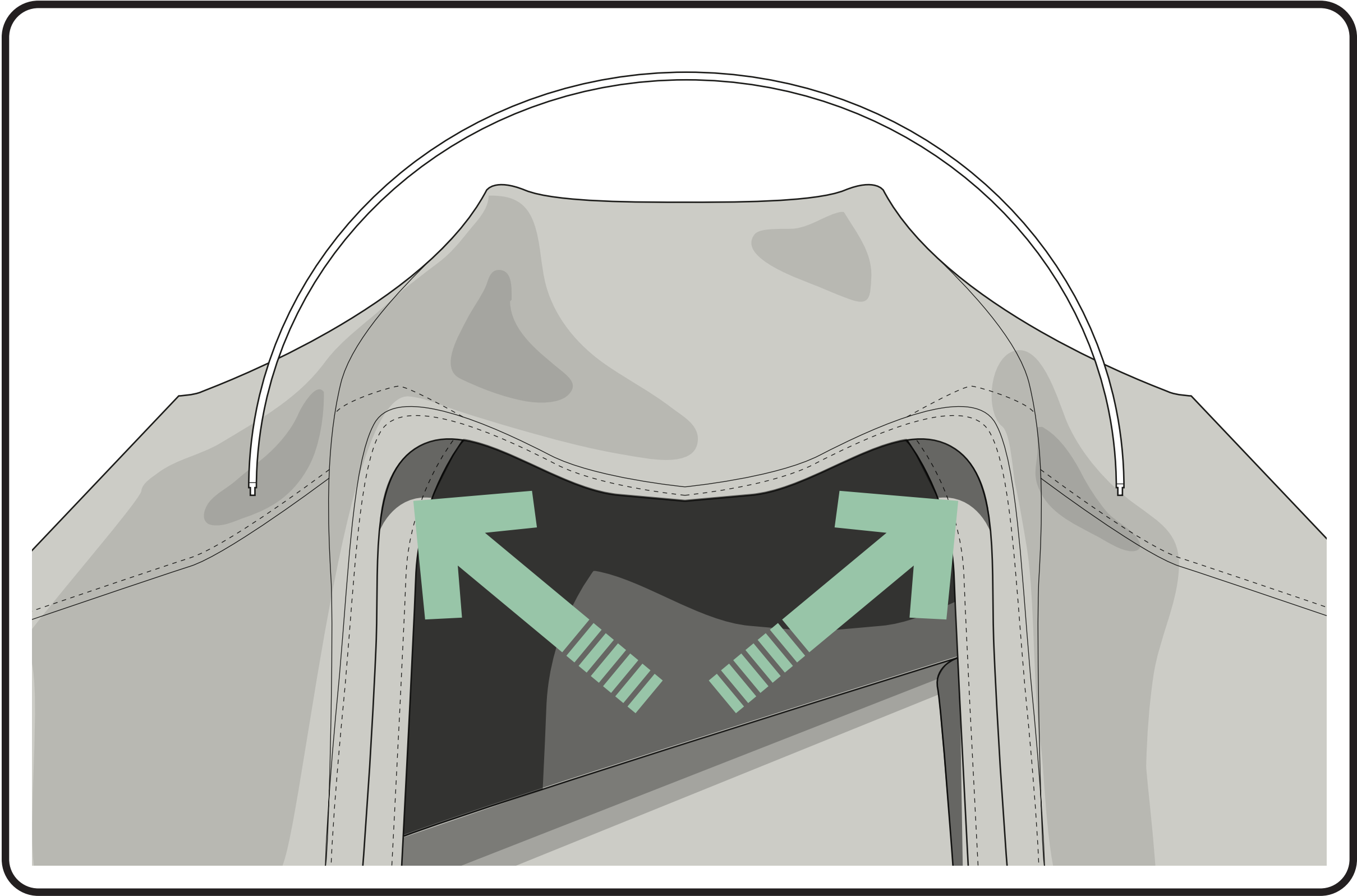

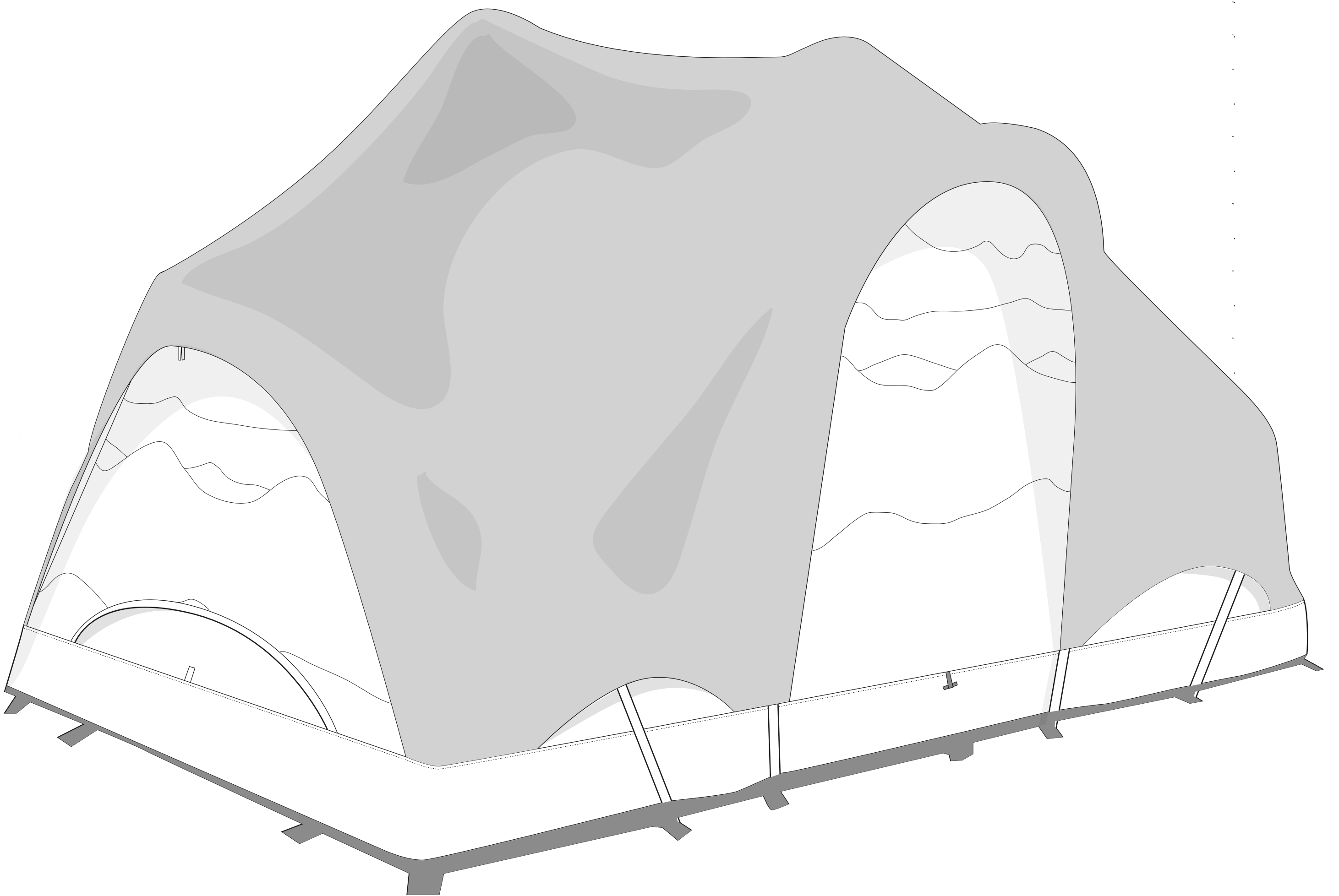
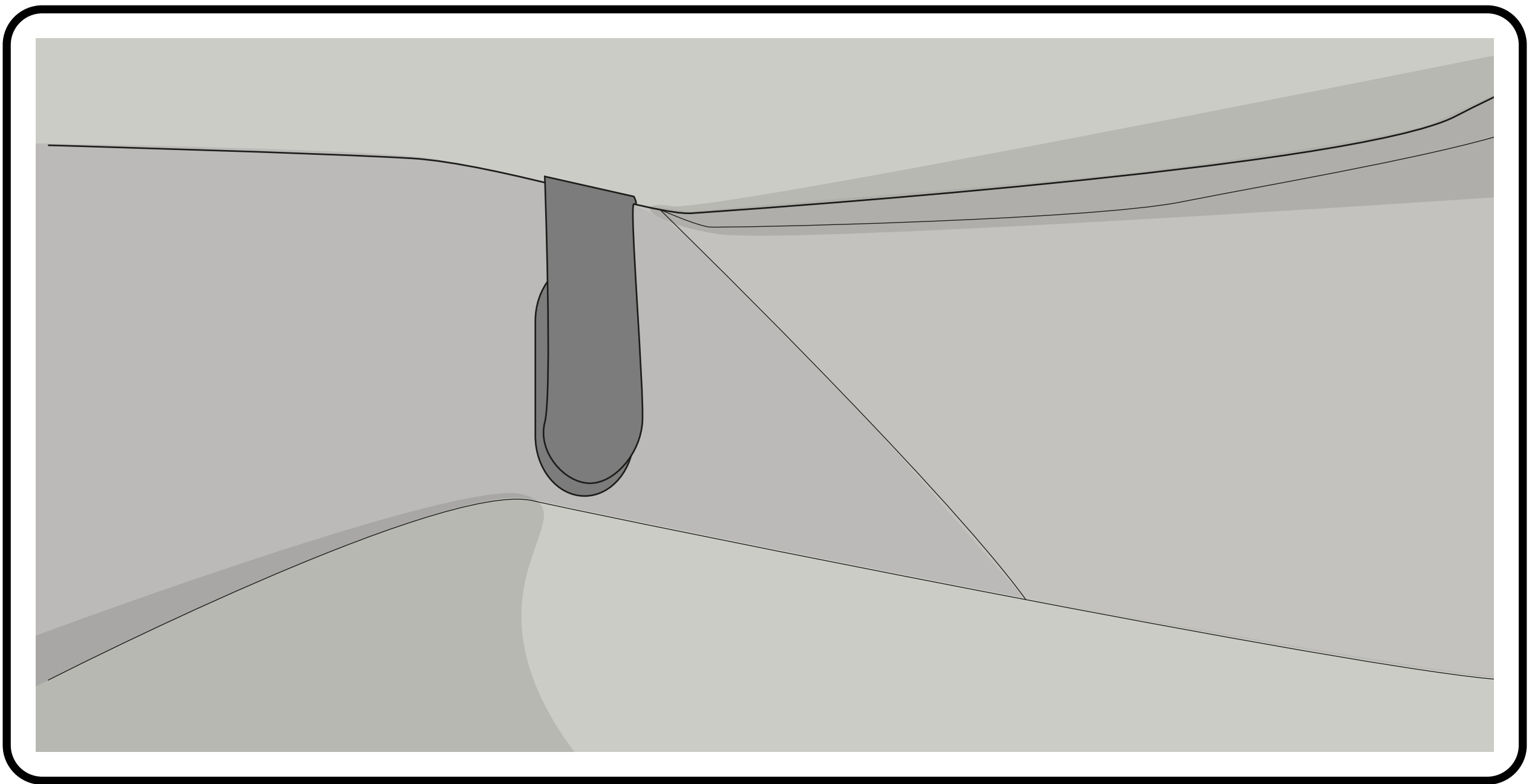
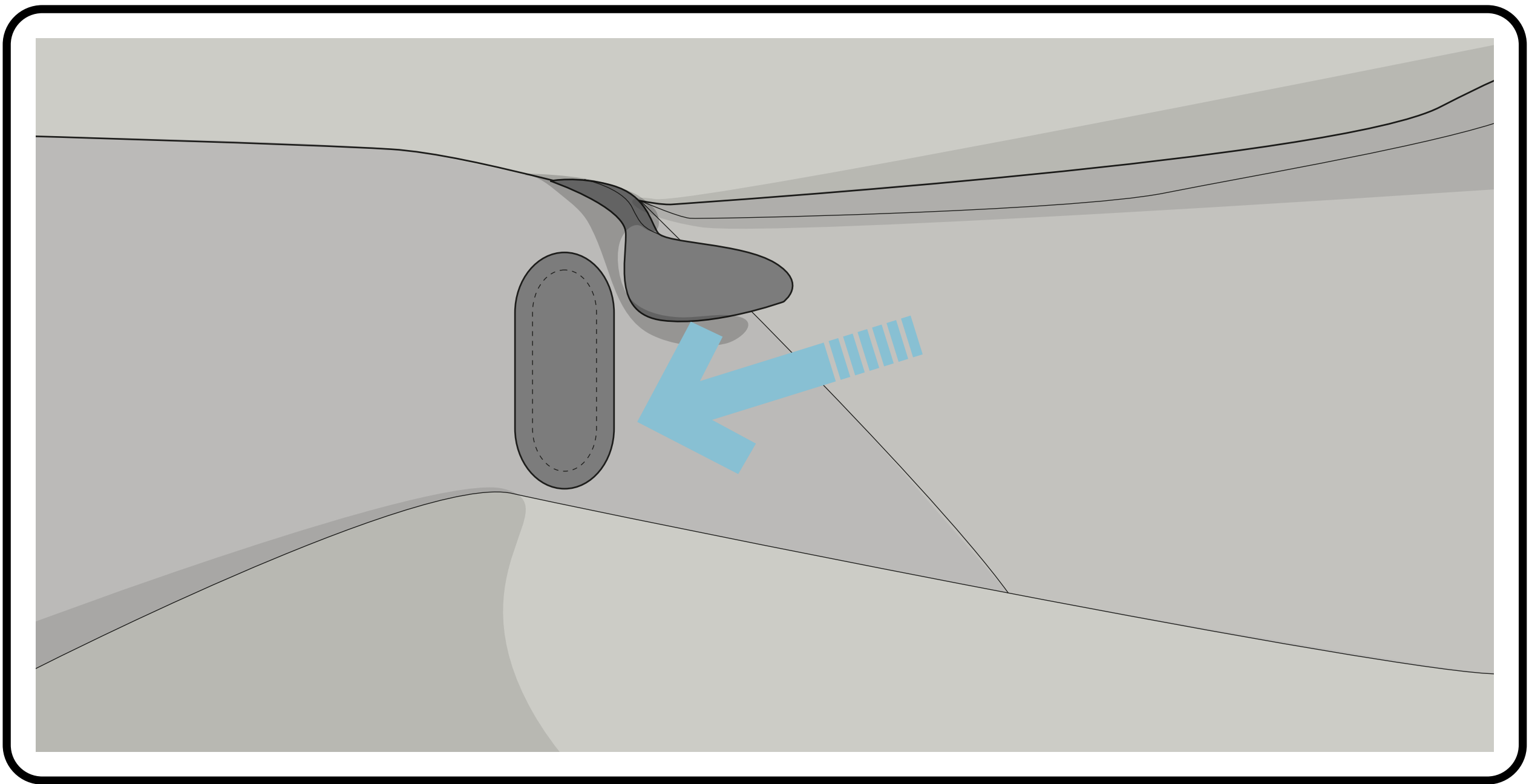

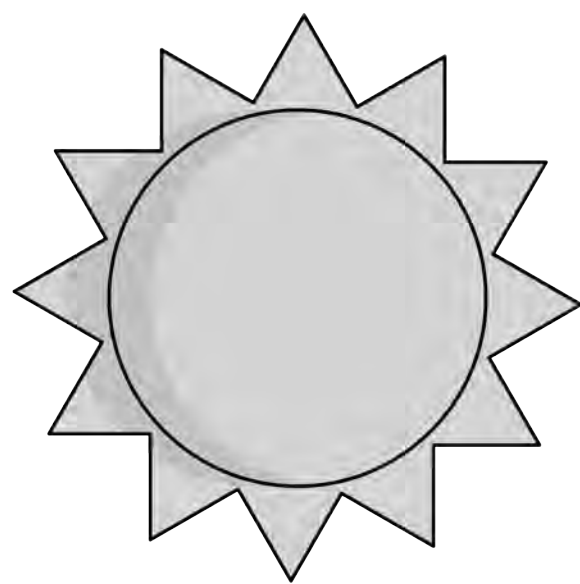
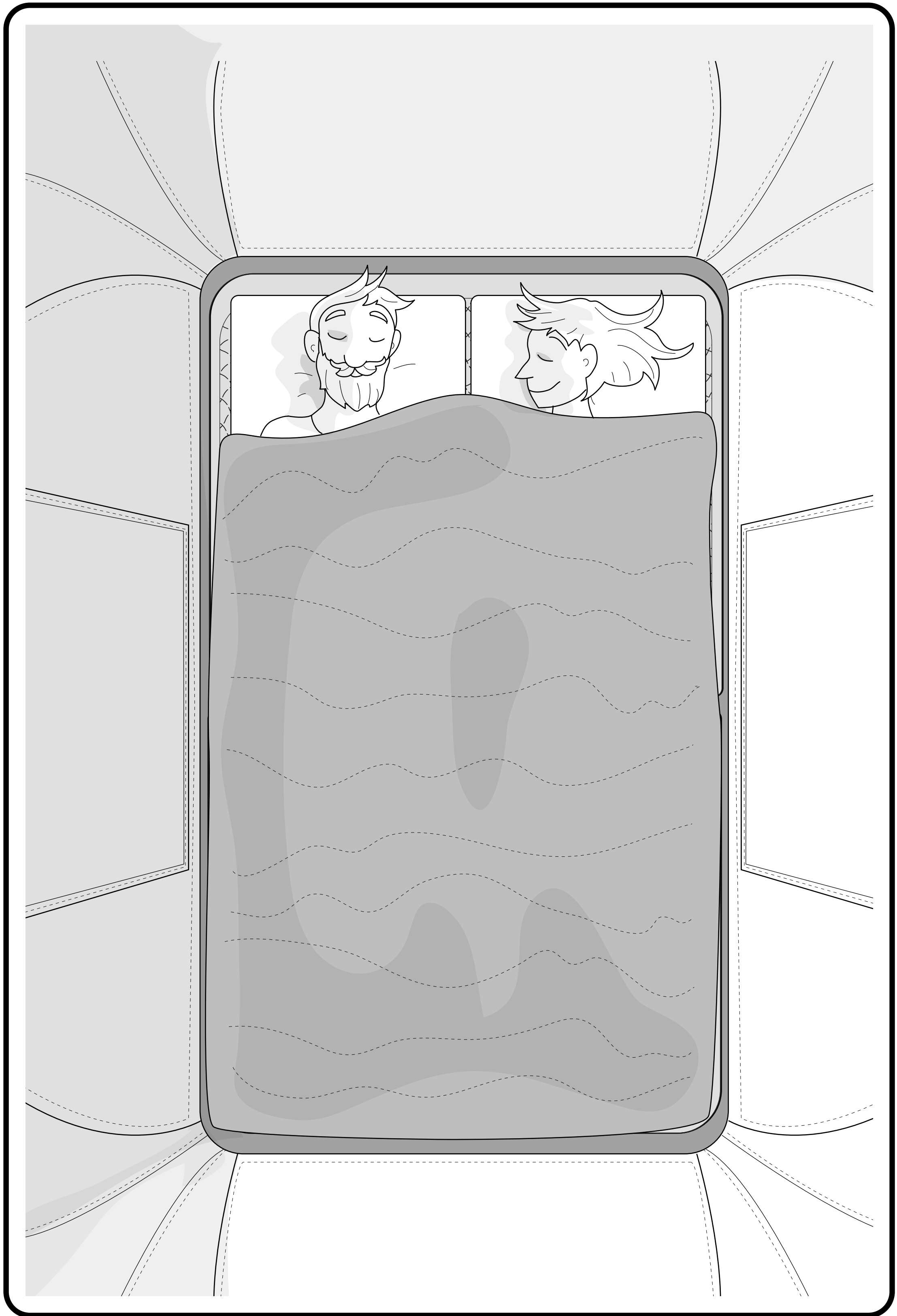
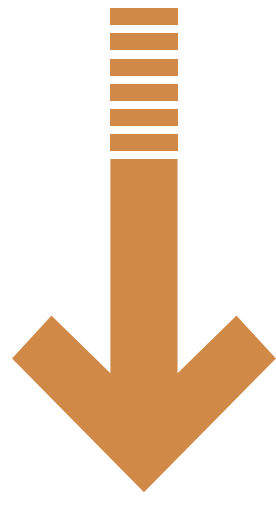
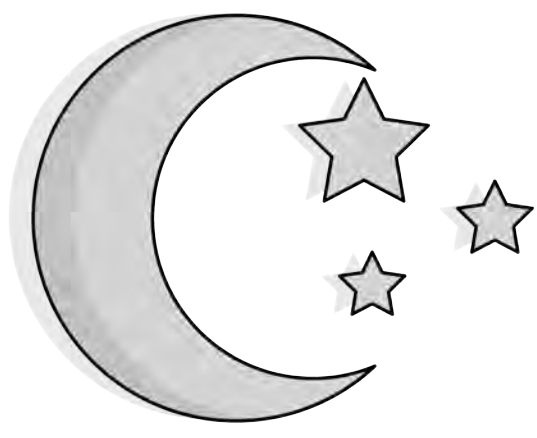

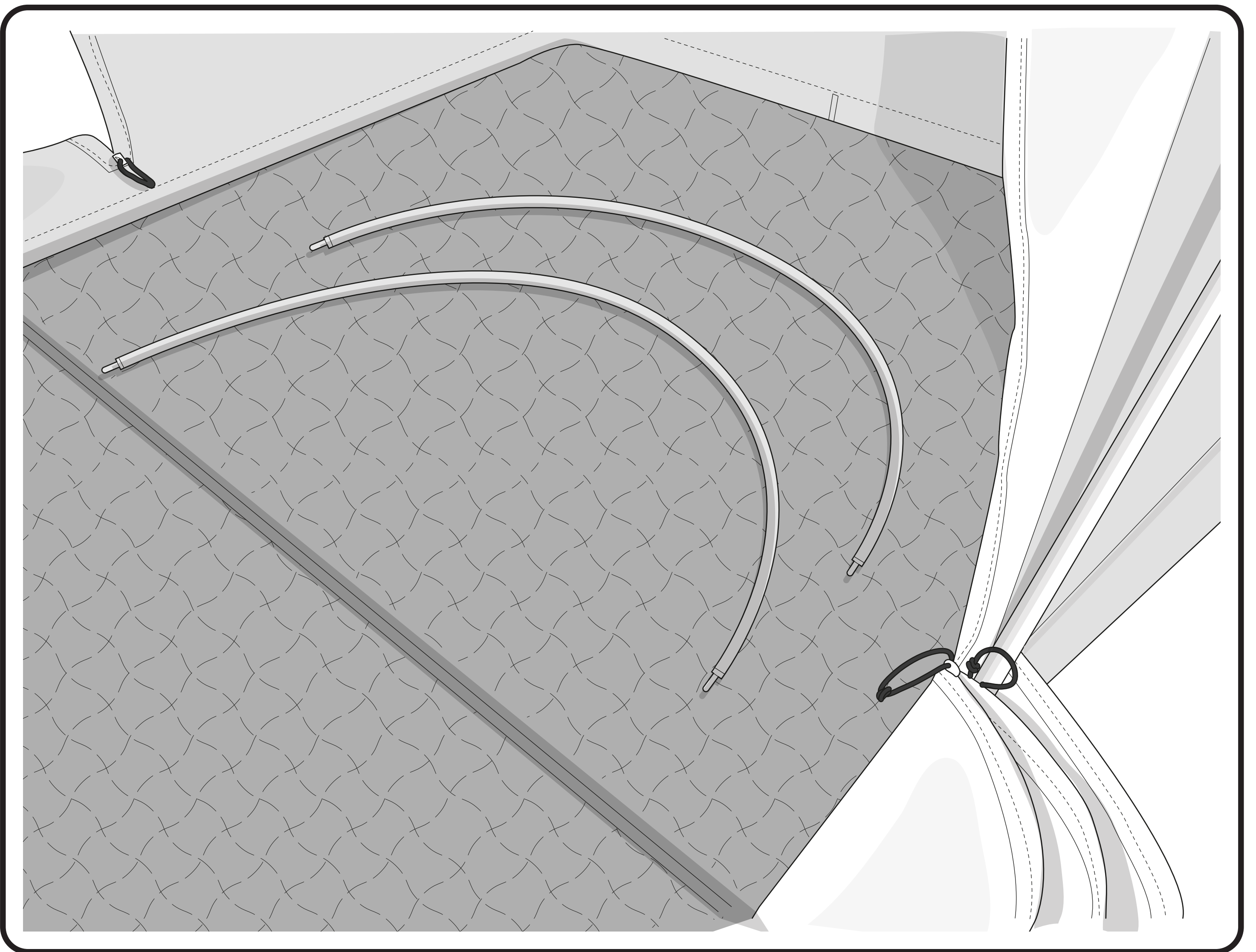

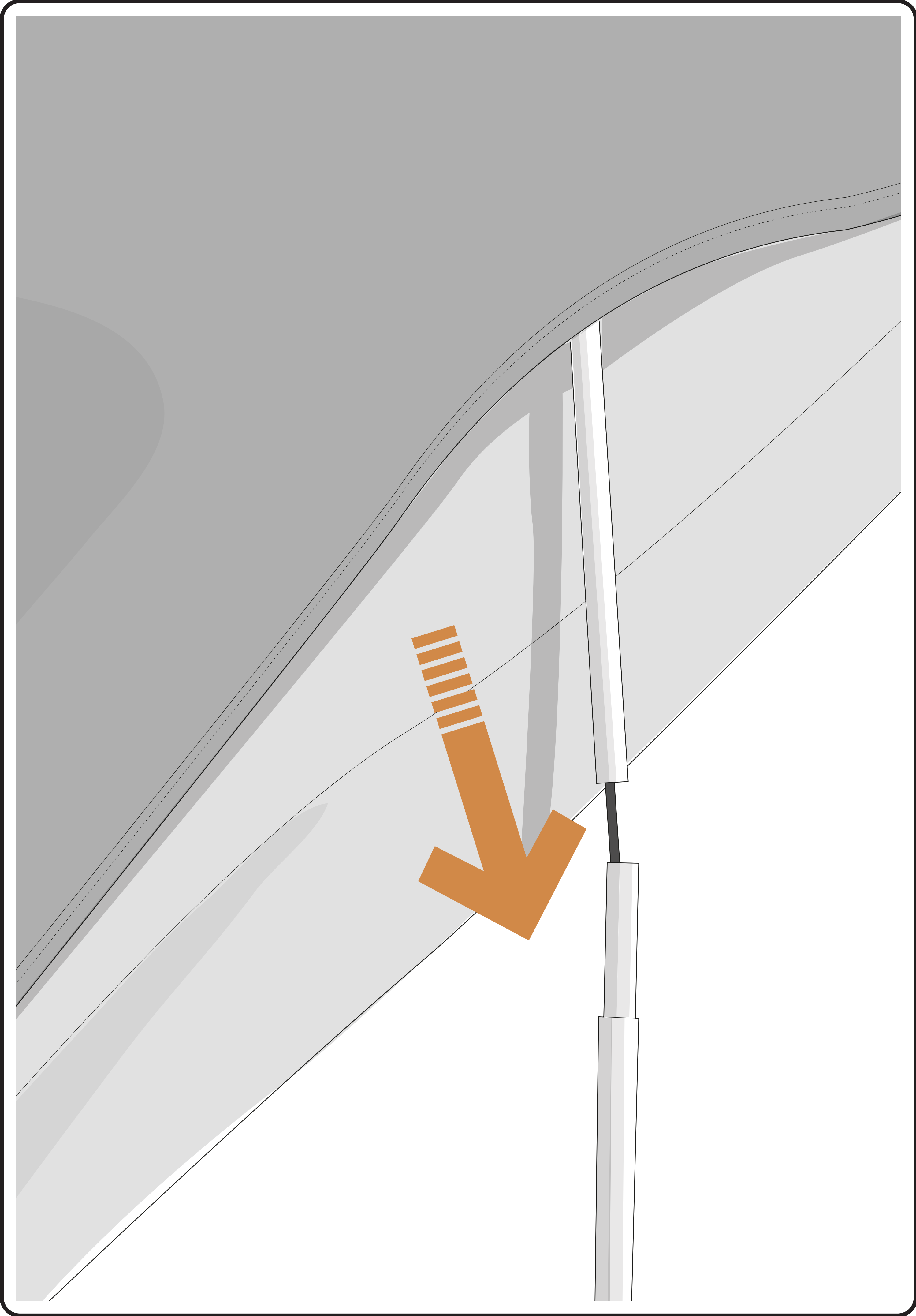

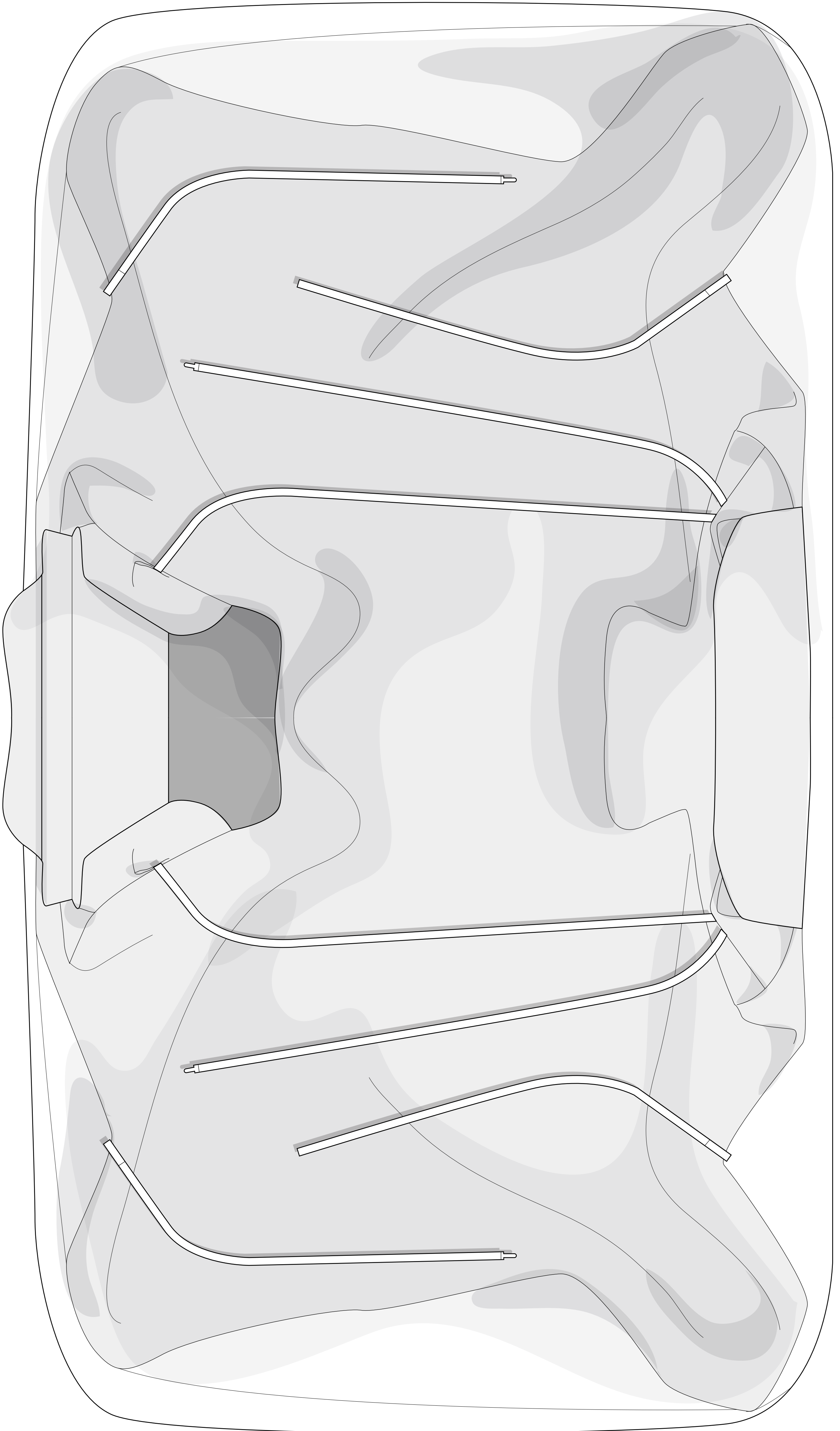

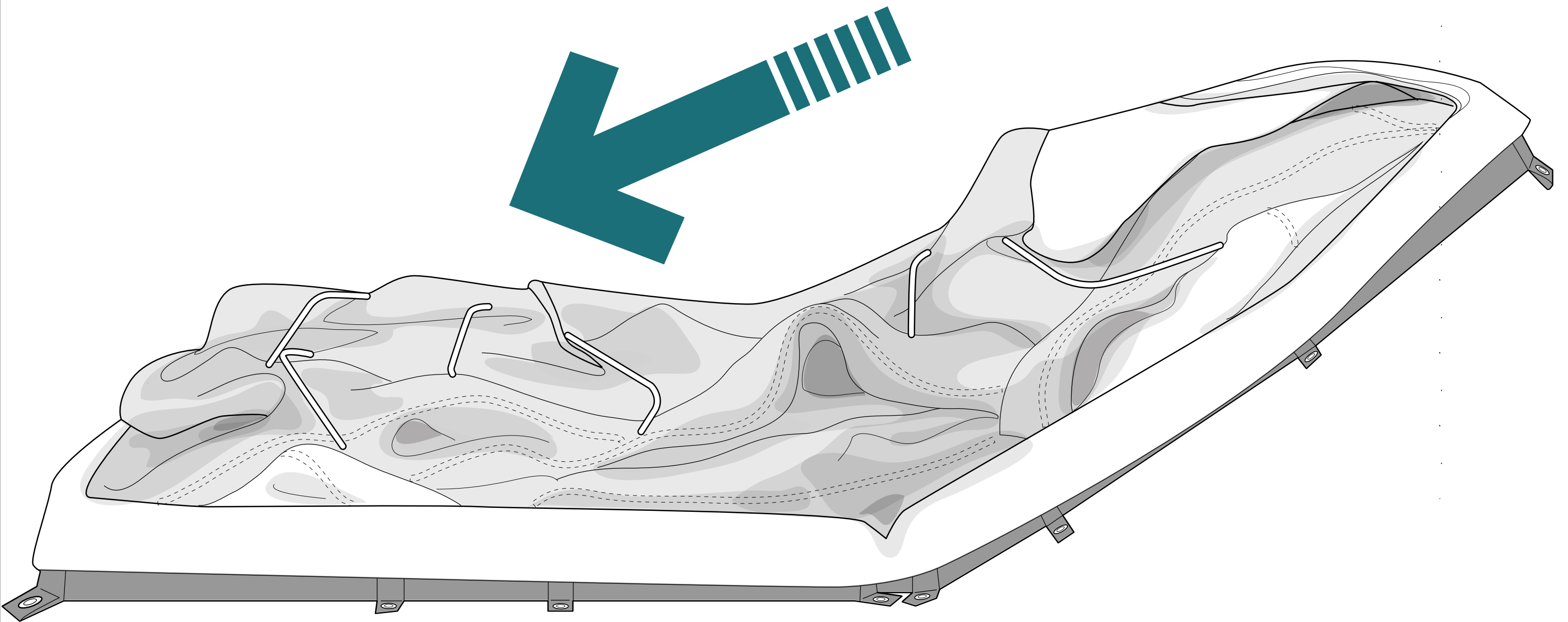

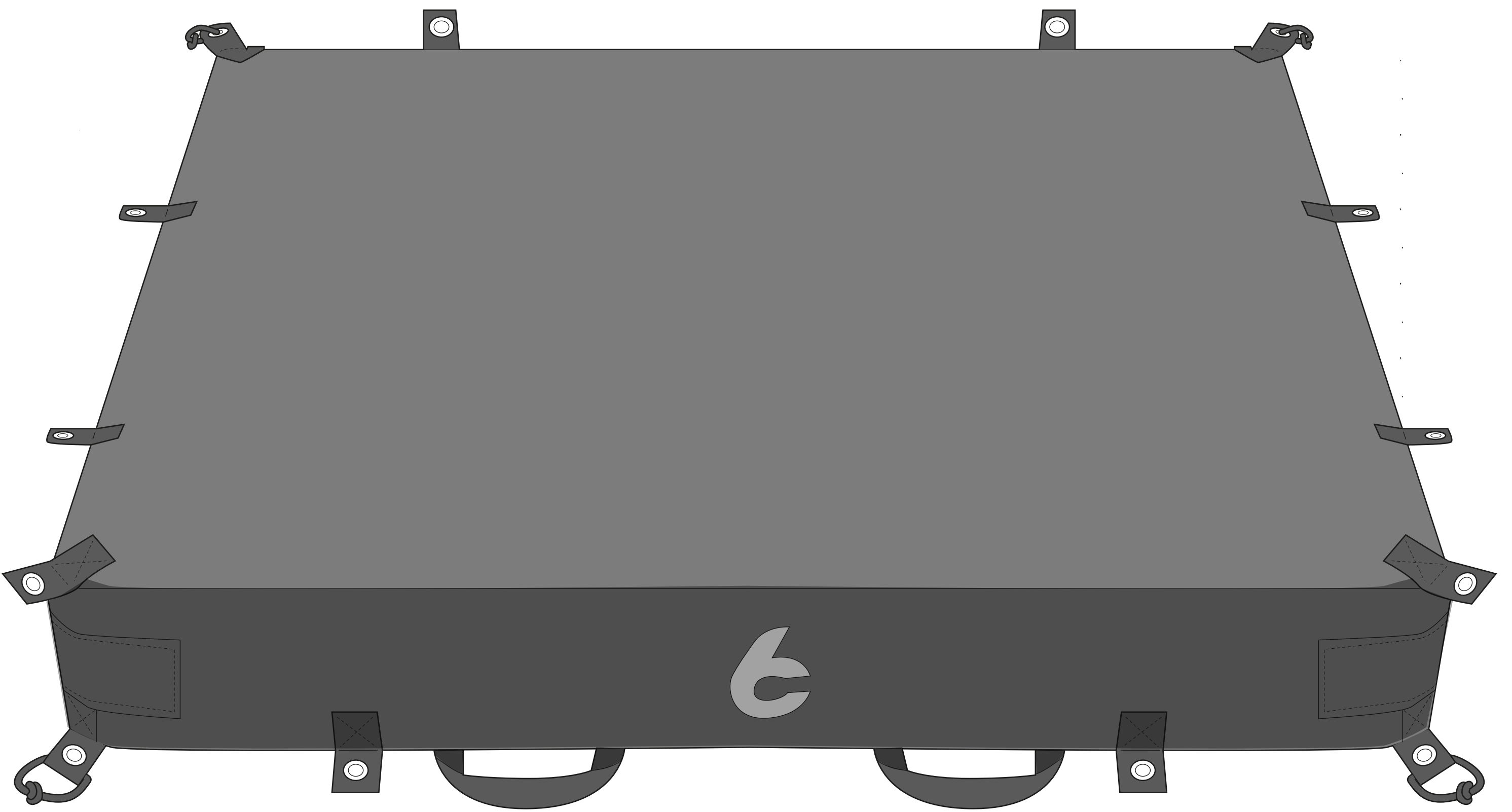

JOIN THE REVOLUTION

C6 outdoor



SHOP REV TENT ACCESSORIES

#RevTent

#RevView

#C6outdoor

support.C6outdoor.com

Share /
Connect





WARNINGS

To extend the usable life of your Rev Tent, we recommend storing the tent out of the sun and weather elements when not in use.

When securing the Rev Tent to a vehicle for transport or sleeping - check all straps and connections often. Failure to properly secure the Rev Tent to a vehicle could result in bodily harm and even death.

Para prolongar la vida útil de su Rev Tent, le recomendamos proteger su tienda de campaña de la luz solar y otras inclemencias climáticas mientras no esté en uso.

Cuando asegure su Rev Tent a un vehículo para transportarla o para dormir, revise las correas y conexiones con frecuencia. El no asegurar correctamente su Rev Tent al vehículo podría ocasionar daños físicos e incluso la muerte.

Um die Nutzungsdauer des Rev Tents zu verlängern, empfehlen wir das Zelt bei Nichtgebrauch vor Sonne und Wetterelementen geschützt zu lagern.

Wenn Sie das Zelt zum Transportieren oder Schlafen an einem Fahrzeug befestigen, überprüfen Sie regelmäßig alle Gurte und Verbindungen. Wenn das Zelt nicht Ordnungsgemäß befestigt wird, kann dies zu Körperverletzungen und sogar zum Tod führen.

Pour prolonger la durée de vie de votre Rev Tent, nous vous recommandons de ranger la tente à l'abri du soleil ou des intempéries lorsqu'elle n'est pas utilisée.

Lorsque vous attachez la Rev Tent à un véhicule pour la conduite ou pour dormir, il est vivement recommandé de souvent vérifier toutes les sangles et connexions. Echouer de proprement sécuriser la Rev Tent aurait pour conséquence le risque d'éventuelles blessures corporelles pouvant être fatales.



WARNINGS

Para maior durabilidade da cabana Rev Tend, recomendamos guarda-la fora do sol e de quaisquer alterações climáticas.

Ao transportar a Rev Tend em seu carro ou ao montá-la para dormir verifique, sempre e periodicamente, as correias e conexões. Falhas na colocação da Rev tend no veículo podem causar sérios acidentes e até a morte.

Per prolungare la vita utile della vostra Rev Tent, si consiglia di conservare la tenda fuori dagli agenti atmosferici e dal sole quando non in uso.

Quando si fissa la Rev Tent ad un veicolo per il trasporto o dormire - controllare tutte le cinghie e i collegamenti. Il mancato fissaggio della Rev Tent a un veicolo potrebbe causare lesioni personali e di morte anche.

Чтобы продлить срок службы вашей палатки Rev Tent, мы рекомендуем хранить ее вдали от солнца и погодных элементов когда она не используется.

Прикрепляя Rev Tent к транспортному средству для транспортировки или сна часто проверяйте все ремни и соединения. Отсутствие надлежащего крепления Rev Tent к транспортному средству может привести к телесным повреждениям и даже смерти.

Rev Tentを長くお使いいただく為に、長期間ご使用にならない時は直射日光や雨などの当たらない場所に保管して下さい。

Rev Tentを車に装着し移動・休憩をする際は、全てのストラップと接続部分のご確認をお願いします。設置不良は死亡事故・大怪我を招く恐れがあります

Rev Tent는 사용하지 않을 때는 태양이나 나쁜 날씨에서는 보관하지 않기를 권고합니다. 운송이나 잠을 자기 위한 차량에

Rev Tent를 고정시킬 때, 모든 끈과 연결부분을 자주 확인하세요. Rev Tent를 차량에 적절히 고정하지 않으면 신체적 해와 죽음에까지 이를 수 있습니다.