

GOBI JEEP JK AEV BRUTE DOUBLE CAB ROOF RACK INSTALLATION INSTRUCTIONS

The rack must be inspected before each use to make certain attachments are secure, and for evidence of wear. Misuse of the rack or failure to observe the manufacturer's instructions as to installation, proper Attachment and maintenance will void warranties that may be implied by law.

TOOLS REQUIRED FOR INSTALLATION:

- 1- 15mm socket or box end wrench**
- 1- 7/16" socket or box end wrench (light bar clamps)**
- 1- 9/16" socket or box end wrench (rear tower and rack)**
- 1- 3/4" socket and 3/4" box end or adjustable wrench (rear bar)**
- 1- 1/2" open end wrench (isolators)**
- 1- Torx bit T-40 (light bar)**

CAUTION

**USE ANTI-SEIZE LUBRICANT
ON ALL SCREWS**

GOBI JEEP JK AEV BRUTE DOUBLE CAB ROOF RACK

INSTALLATION INSTRUCTIONS

Guidelines:

When using Load Carriers and Accessories, the user must understand the precautions. The points listed below will assist you in using the rack /carrier system and will encourage safety.

- For quality fits and safty, use only the recommended rack or accessory. Do not assume an accessory will fit, always check with dealer when obtaining new accessories. Use only approved accessories on load carriers. Using other brands will void your warrenty.
- Make sure all knobs, bolts, screws, straps, and locks are firmly attached, tightened and locked before every trip. Knobs, bolts, screws, straps, and locks must be periodically inspected for signs of wear, corrosion, and fatigue. Check your load at stops during the trip to insure continued fastening security.
- Check local and state laws governing projection of objects beyound the width of a vehicle. **Be aware of the width and height of your cargo since low clearance branches, bridges, and parking garages can affect the load** All cargo will affect the vehicle's driving behavior. Never drive with any lock, know, or rack in an open or unlocked position. All long loads such as, but not limited to sailboards, surfboards, kayaks, canoes, and lumber must be tied down front and rear to the bumpers or tow hooks, of the vehicle.
- Remove your rack accessories when they are not in use, before intering car washes, prior to taking in your vehicle for service, and whenever clearance may be an issue.
- All locks must be turned and moved periodically to insure smooth operation. Use graphite or similar dry lubricant to help this. Locks are designed to deter vandalism and theft. Remove valuable gear if your vehicle is unattended for an extended period. Place at least one key in the glove compartment.
- For safety to your vehicle and rack system, obey all posted speed limits and traffic cautions. Adapt your speed to the conditions of the road and the load being carried.
- Do not use load carriers and accessories for purposes other than those for which they were designed. Do not exceed their carrying capacity.
- Consult with your dealer if you have any questions regarding the operations and limits of this product. Review all instructions carefully.

*** READ ALL INSTRUCTIONS CAREFULLY PRIOR TO INSTALL ***

GOBI JEEP JK AEV BRUTE DOUBLE CAB ROOF RACK INSTALLATION INSTRUCTIONS

Included in kit

Letter	Description	Location	Quantity
A	GOBI JEEP JK AEV BRUTE DOUBLE CAB ROOF RACK	Main box	1
B	GOBI JEEP JK AEV BRUTE FRONT LIGHT BAR	Strapped to Rack	1
C	GOBI JK AEV BRUTE REAR RACK SUPPORTS PASSENGER & DRIVER	Strapped to Rack	1 ea.
D	REAR RACK SUPPORT TOWERS PASSENGER AND DRIVER	Hardware Box	1 ea.
E	REAR TOWER SUPPORT PLATES PASSENGER AND DRIVER	Hardware Box	1 ea.
F	GOBI FRONT LIGHT BAR CLAMPS	BAG #2	2
G	GOBI WINDSHIELD BODY PROTECTION	BAG #3	2
H	<p>GOBI RACK MOUNTING HARDWARE</p> <p><u>CONTENTS:</u> 4- Black nylon shoulder washers 2- 3/8-16 x 1-1/4" SS carriage screw 4- 1/2" Flat washer SS 1- Packet Anti-seize lubricant 2- 1/2" x 2-1/2" Hex head bolts SS 4- Rear support bar position plates 2- 1/2" Nylock nuts SS 8- 3/8-16 x 1" Hex head screw SS 4- 1/4-20 x 1" hex head screw SS 24- 3/8" Flat washer SS 4- 1/4" lock washer SS 16- 3/8" Nylock nuts SS 4- 1/4" flat washer SS 6- 3/8 x 1" Carriage screws SS 2- 1-1/2" x 1-1/2" brown wear pad</p>	BAG #4 Hardware Box	1
I	<p>GOBI RACK ISOLATOR WEAR PLATE</p> <p><u>CONTENTS:</u> 2- Black Triangular adhesive backed wear plates (Place on vehicle body under Rubber Isolators)</p>	BAG #5 Hardware Box	1

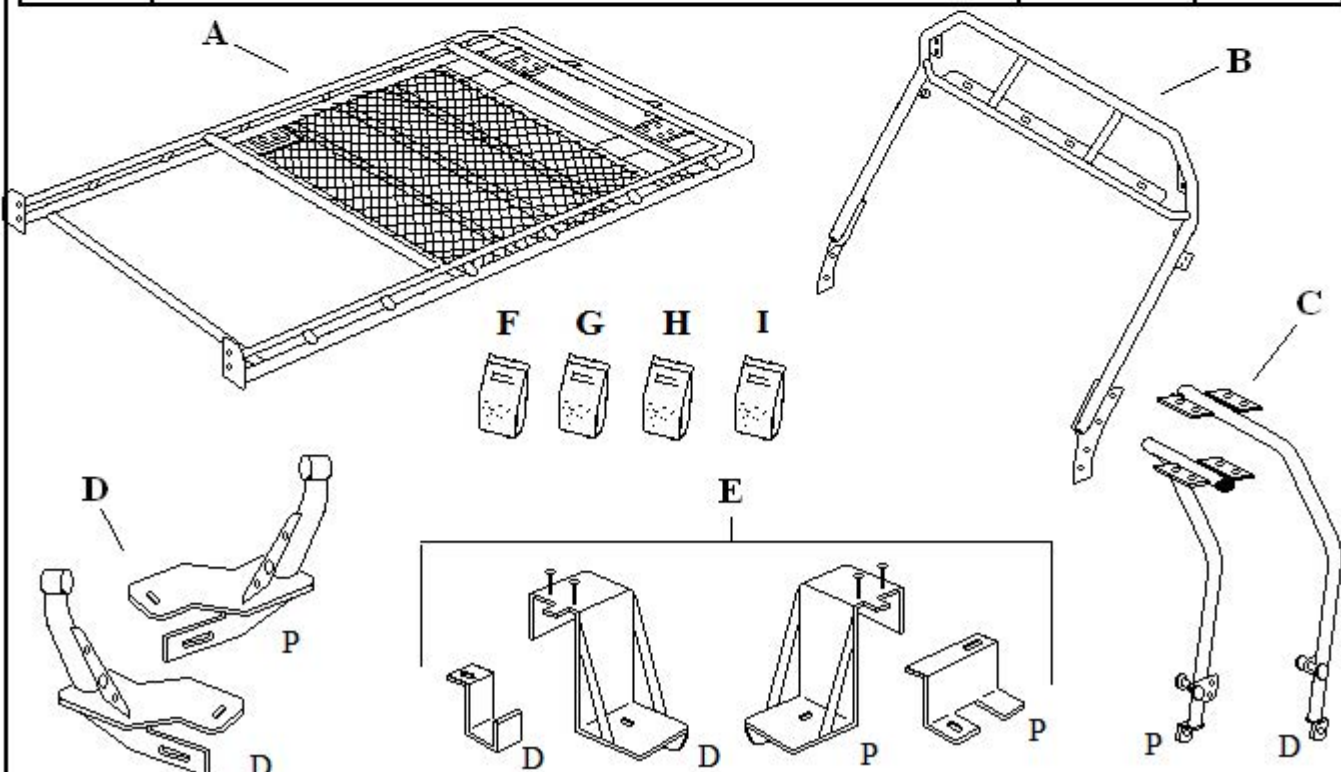

GOBI JEEP JK AEV BRUTE DOUBLE CAB ROOF RACK INSTALLATION INSTRUCTIONS

Fig. 1**Fig. 2**

Remove from your hardware kit windshield body protection covers (G) located in Bag #3. Take out the passenger side cover indicated by the letter (P) on the front lip of the cover as shown in Fig.1. Place the cover on the passenger side top corner of your windshield as shown in Fig. 2 and Fig. 3 shift the cover around slightly until it sits firmly on the corner of the windshield then place a piece of masking tape on the windshield next to both edges of the cover as shown in Fig. 3 to indicate position.

Fig. 3**Fig. 4**

Remove the cover from the masking tape markers and clean the area inside the masking tape markers with denatured alcohol let dry for 30 seconds then peel off the adhesive protective film from inside the cover as shown in Fig. 4 and set back inside masking tape markers placing the lip of the cover back into the recess on the edge of the windshield glass as shown in Fig. 2 then set the entire cover on the windshield frame as shown in Fig. 3 pressing down firmly for at least 30 seconds. Apply the same procedure to the driver side.

GOBI JEEP JK AEV BRUTE DOUBLE CAB ROOF RACK INSTALLATION INSTRUCTIONS

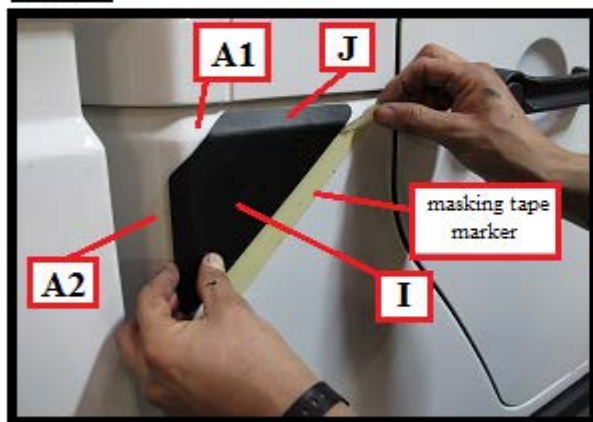
Fig. 5**Fig. 6**

Remove the rear triangular wear plate (I) located in Bag #5 of your hardware kit. Take out the passenger side wear plate indicated by a longer bend at the top of the plate (J) as shown in Fig. 5 and Fig. 7. Do not peel off the protective adhesive film at this time and place the wear plate over the rear upper passenger side formed corner of the body (A1) and (A2) shown in Fig. 5. Move the wear plate around until it fits tightly on the corner then place a masking tape marker as shown in Fig. 5 under the plate.

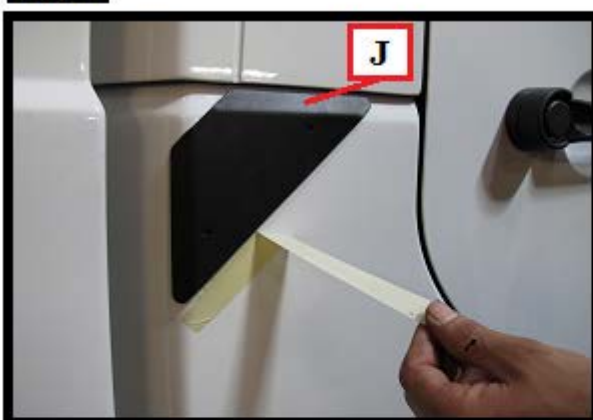
Fig. 7**Fig. 8**

Remove the wear plate from the masking tape marker and clean the area where the wear plate will sit with denatured alcohol let sit for 30 seconds to dry. Peel off the adhesive backed protective film from the back of the wear plate as shown in Fig. 6 and set back onto the rear upper corner as shown in Fig. 7 of the vehicle using the masking tape marker as guide. Once set in place apply pressure for at least 30 seconds then remove the masking tape. Apply the same procedure to the driver side.

GOBI JEEP JK AEV BRUTE DOUBLE CAB ROOF RACK INSTALLATION INSTRUCTIONS

Fig. 9**Fig. 10**

Remove the clear protective wear strip (K) attached to the back of the wind deflector strapped to the roof rack. Clean the area on the windshield frame just above the windshield as shown in Fig. 9 with denatured alcohol. Mix and apply the following formula to the windshield frame:

*Wetting Solution: 25% isopropyl alcohol, 75% distilled water, and 1 teaspoon dishwashing liquid per gallon. works best if dispensed from a spray bottle.

Apply above 50 deg. F to a surface that is free of dirt, grease and oil. Wide width applications should apply wetting solution * and plastic squeegee to remove trapped air.

Peel the clear protective tape from the paper backing and apply as shown in Fig. 10 then let dry for at least 30 minutes.

COMPLETE THE INSTALLATION OF THE WIND DEFLECTOR AFTER THE LIGHT BAR HAS BEEN FULLY INSTALLED

Fig. 11

Remove 4 Torx head screws from the driver and passenger side windshield as shown above using a #40 TORX head bit.

Fig. 12

Install the Gobi light bar by sliding on the passenger side first as shown above

GOBI JEEP JK AEV BRUTE DOUBLE CAB ROOF RACK

INSTALLATION INSTRUCTIONS

Fig. 13

Thread in the lower screw first as shown

Fig. 14

Pull the driver side in place in the same manner as the passenger side and thread in the lower screw

Fig. 15

Thread in the remaining screws both sides, snug down only at this time.

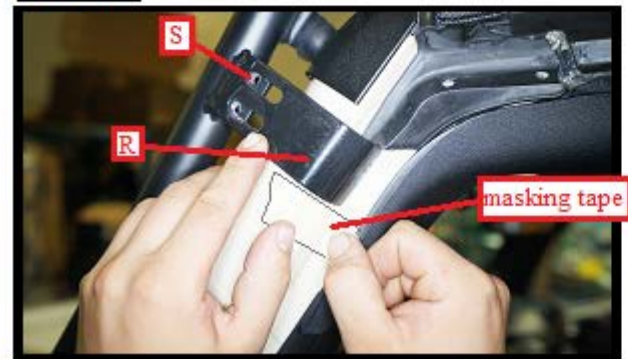
Fig. 17

Place clamp hook (R) as shown inside door jam and align with screw holes (S) on light bar mount then place a piece of masking tape next to clamp edge on vehicle as shown

Fig. 16

Remove clamp hook (R) from Bag #2 of your hardware kit

Fig. 18

Remove from Bag #2 a piece of brown wear tape and attach to inside door jam next to masking tape marker as shown above.

GOBI JEEP JK AEV BRUTE DOUBLE CAB ROOF RACK

INSTALLATION INSTRUCTIONS

Fig. 19

Install clamp hook (R) over wear tape inside door jam and on light bar mount as shown above then place clamp plate (P) over clamp hook (R) and thread in two 1/4-20 x 1" hex head screws, lock washers and flat washers located in Bag#2 of your hardware kit. Snug down only at this time.

Fig. 20

Pull light bar back towards vehicle as shown and at the same time push clamp hook up against door jam then tighten both hex head screws fully. Apply the same procedure to the passenger side.

Fig. 21

Installation of light bar clamps completed

Fig. 22

Fully tighten all remaining Torx head light bar screws as shown driver and passenger sides. Light bar install completed

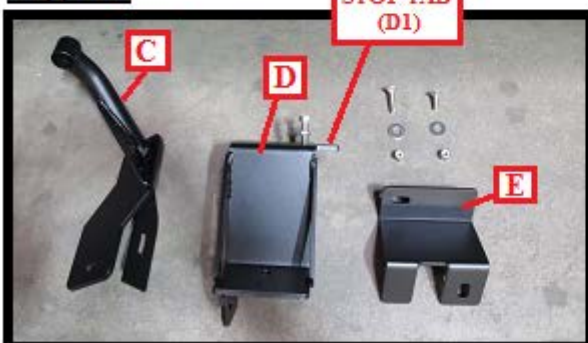
Fig. 23

Remove the above tower support parts from your hardware box

- 1- Passenger side tower (C)
- 1- Passenger side tower support (D)
- 1- passenger side tower support clamp (E)
- 1-3/8-16 x 1-1/4" SS carriage screw, 1-3/8-16 x 1" SS carriage screw
- 2- 3/8" SS flat washer, 2- 3/8" SS nylock nut

Fig. 24

Passenger side view of vehicle frame where tower support (D) is to be installed.

GOBI JEEP JK AEV BRUTE DOUBLE CAB ROOF RACK

INSTALLATION INSTRUCTIONS

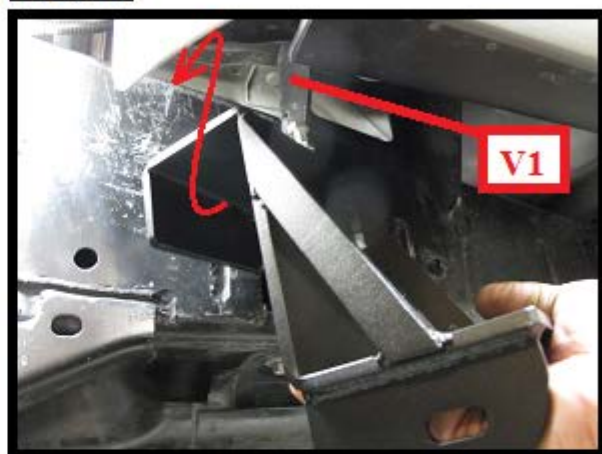
Fig. 24**Fig. 25**

Install the passenger side tower support plate (D) as shown in Fig. 24 up over the rear passenger side vehicle frame indicated by a red arrow Fig. 25. Make certain stop tab (D1) on the right side of tower support plate (D) is contacting the frame body damper support (V1) shown in Fig. 25 and Fig. 26.

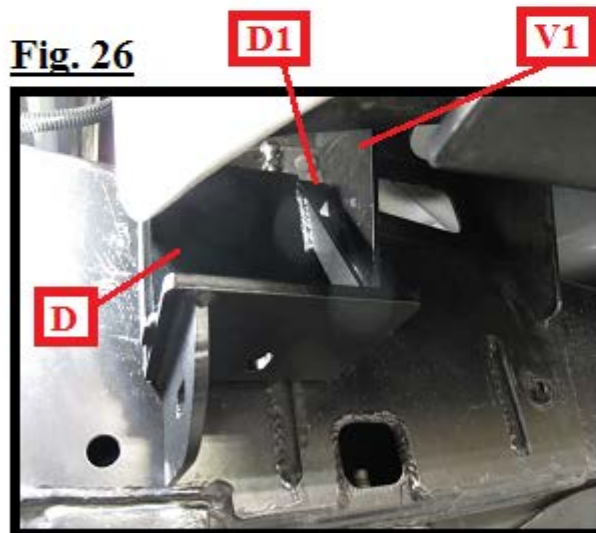
Fig. 26**Fig. 28**

bump

**Fig. 27**

Place a small level on the base of the passenger side tower support plate as shown in Fig. 27. Level tower support plate by adjusting both leveling screws (D3) shown in Fig. 28 located on top of the tower support plate either up or down until tower plate (D) is level. Once the tower plate has been leveled secure leveling screws firmly by tightening the jam nuts on the tower support plate leveling screws (D3) as shown in Fig. 28 using a 9/16" open end wrench.

GOBI JEEP JK AEV BRUTE DOUBLE CAB ROOF RACK INSTALLATION INSTRUCTIONS

Fig. 29

Remove the hex head screw from the bottom of the passenger side vehicle frame just below the recently installed tower support plate (D) as shown in Fig. 29. Install tower support plate clamp (E) as shown in Fig. 30 under the vehicle frame and secure in place with the screw just removed in Fig. 29. Push the clamp firmly against the frame and fully tighten hex screw.

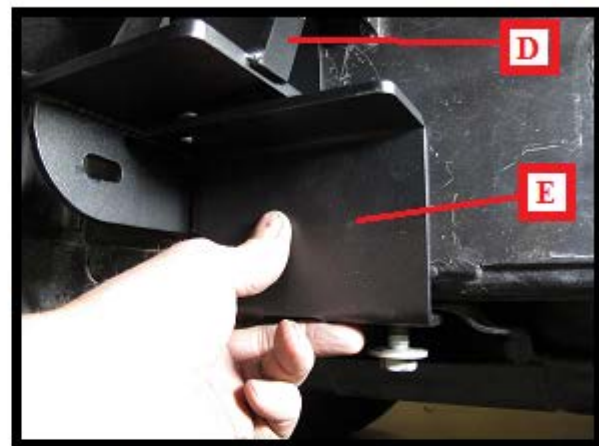
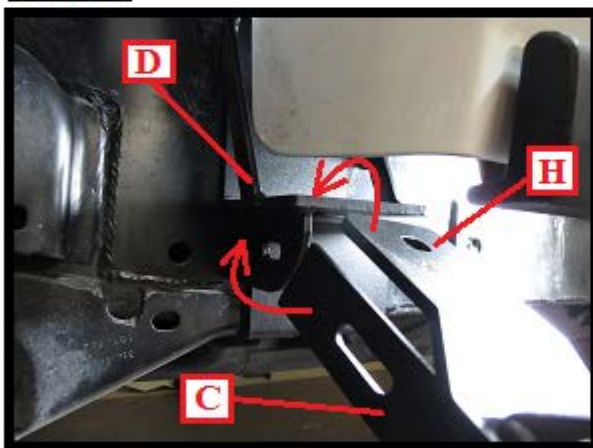
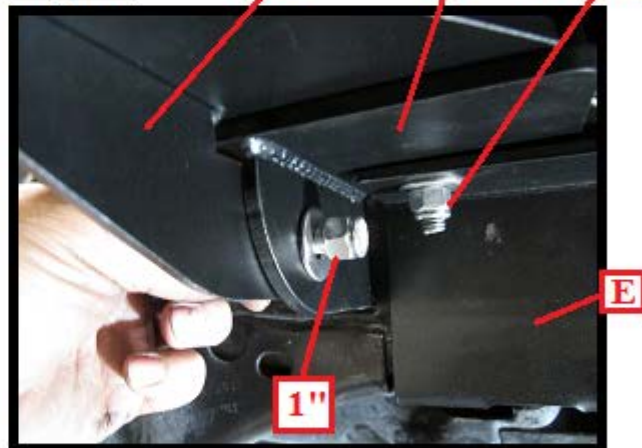
Fig. 30**Fig. 31****Fig. 32**

Place tower (C) up onto the base of tower support plate (D) as shown in Fig. 31 by red arrows and Fig. 32 set in place. Slide tower (C) back as far as possible and install 1-3/8-16x1-1/4" SS carriage screw into the rear tower hole (H) shown in Fig. 31 down through tower support plate (D) and through clamp (E) as shown in Fig. 32. Thread on a 3/8" flat washer and 3/8" nylock nut and snug down only at this time. Install 1-3/8-16x1" SS carriage screw through the side of tower (C) shown in Fig. 32 and thread on one 3/8" flat washer and 1-3/8" nylock nut and snug down only at this time.

GOBI JEEP JK AEV BRUTE DOUBLE CAB ROOF RACK INSTALLATION INSTRUCTIONS

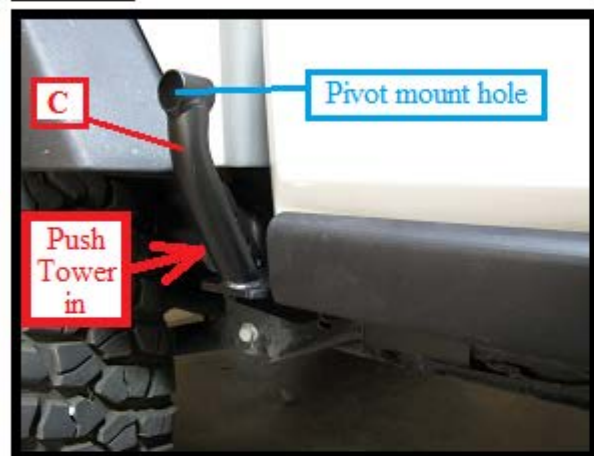
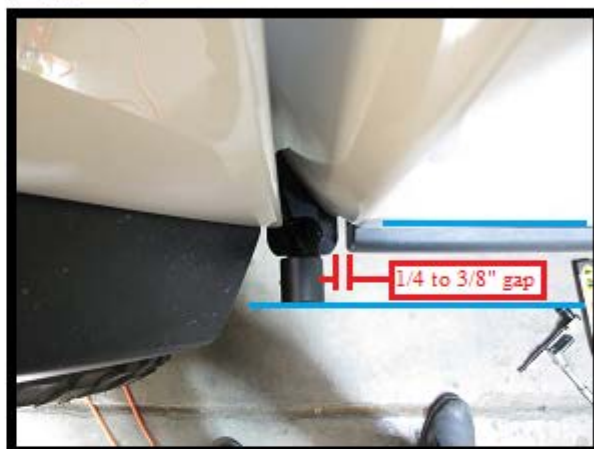
Fig. 33**Fig. 34**

Position tower (C) as far inward towards the vehicle as possible and provide a gap of approximately 1/4" to 3/8" between the vehicle rock rail and the base plate of tower (C) shown in Fig. 34. Make certain the pivot mount hole at the top of tower (C) is aligned with the body of the vehicle as indicated by two blue lines one on the vehicle body and the other on the outer pivot mount of tower (C). Once aligned fully tighten all carriage screws securing tower (C) in place. Passenger side tower install completed.

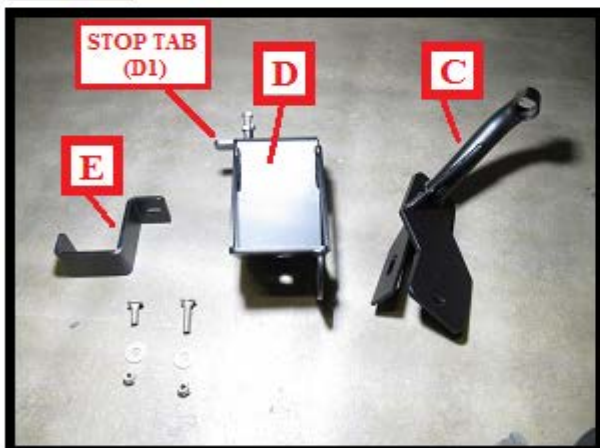
Fig. 35**Fig. 36**

Remove the above tower support parts from your hardware box:

- 1- Driver side tower (C)
- 1- Driver side tower support (D)
- 1- Driver side tower support clamp (E)
- 1- 3/8-16 x 1-1/4" SS carriage screw, 1- 3/8-16 x 1" SS carriage screw
- 2- 3/8" SS flat washer, 2- 3/8" SS nylock nut

Install tower support plate (D) up onto the rear driver side vehicle frame as performed on page 9 Fig. 24 thru Fig. 27.

GOBI JEEP JK AEV BRUTE DOUBLE CAB ROOF RACK INSTALLATION INSTRUCTIONS

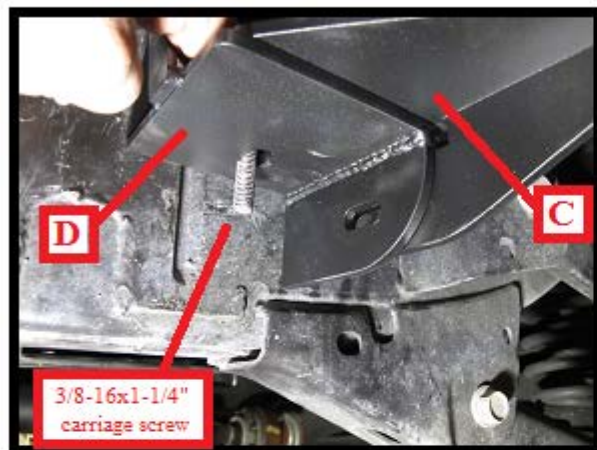
**Fig. 37**

Install the driver side tower (C) onto the driver side tower support plate (D) as performed on page 10 Fig. 31 and thread 1- 3/8-16 x 1-1/4" carriage screw through the base plate of tower (C) then into the tower support plate (D) as shown in Fig. 37.

**Fig. 38**

Hold tower (C) in place with one hand and install the driver side tower support clamp (E) around the bottom of the vehicle frame and up onto the 3/8-16x1-1/4" carriage screw. Use 1- 3/8" flat washer and 1- 3/8" nylock nut located in Bag #4 of your hardware kit to hold in place. Snug down only at this time.

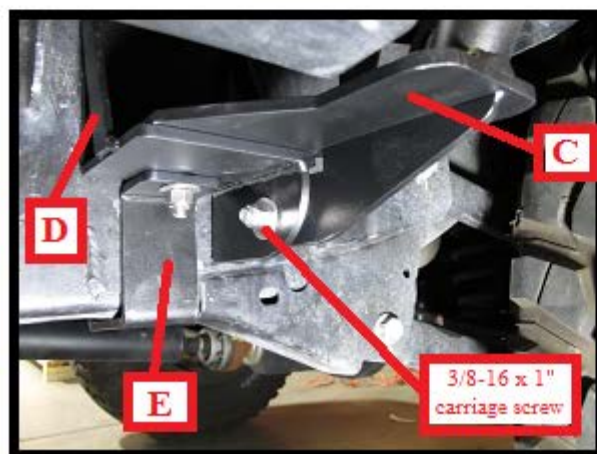
**Fig. 39**

Thread 1- 3/8-16 x 1" carriage screw into the side of tower (C) as shown in Fig. 39 and perform the same installation procedure as was completed on page 10 Fig. 31-32 and page 11 Fig. 33-34. Driver side tower install completed.

GOBI JEEP JK AEV BRUTE DOUBLE CAB ROOF RACK

INSTALLATION INSTRUCTIONS

Fig. 40

Place a clean blanket over the top of your vehicle roof then slide the Gobi roof rack (A) with the help of another person over the hard top as shown in Fig. 40 up against the rear of light bar (B) shown in Fig. 41.

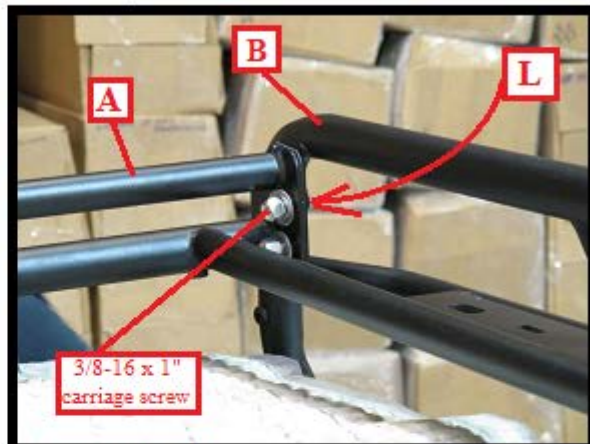
Fig. 41

Use 4- 3/8-16x1" carriage screws two per side of light bar (B) located in Bag #4 of your hardware kit.

Make certain that you push the screws in from the front of the light bar in the direction of red arrow as shown in Fig. 41 then into the roof rack. Thread on 1- 3/8" flat washer and 1- 3/8" nylock nut per screw and snug down. Do not fully tighten at this time.

Fig. 42

Locate the passenger side rear rack support (C) as shown on page 3 of your hardware list. Install as shown in Fig. 42 and Fig. 42a with the welded on tab "L" mounted to the outside of the passenger tower pivot socket. Use 1- 1/2-13x1-1/2" hex head screw, 2-1/2" flat washers, 2-black nylon bushings and 1-1/2" nylock nut located in Bag #4 of your hardware kit in the order shown in Fig. 42. Do not fully tighten at this time.

Fig. 42a

GOBI JEEP JK AEV BRUTE DOUBLE CAB ROOF RACK INSTALLATION INSTRUCTIONS

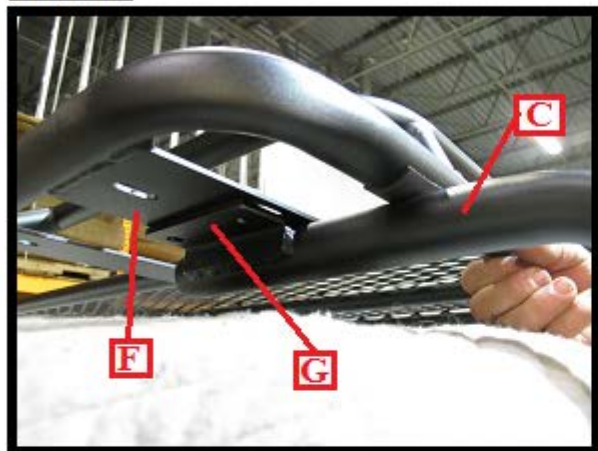
Fig. 43

Lift the rear passenger side corner of the roof rack and slip the rear passenger side support bar (C) under as shown in Fig. 43. Line up all four holes of the support bar welded in flanges (G) with the four holes in the roof rack support bar mount plate (F).

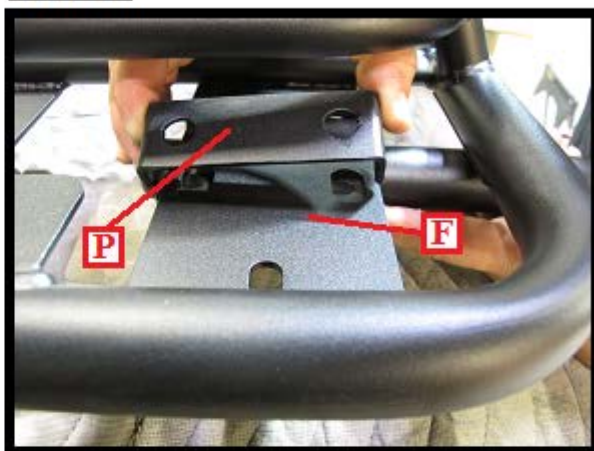
Fig. 44

Remove from Bag #4 of your hardware kit 2 rear support bar positioning plates (P) as shown in Fig. 44. Place positioning plates (P) over the roof rack support bar mount plate (F) and rear support bar welded in flanges (G) shown in Fig. 43.

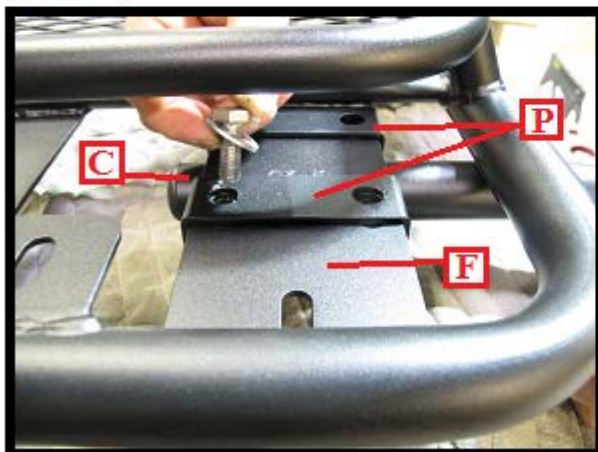
Fig. 45

Remove from Bag #4 of your hardware kit 4- 3/8-16x1" hex head screws, 8-3/8" flat washers and 4- 3/8" nylock nuts and secure both rear supports bar positioning plates (P) in place as shown in Fig. 45. You may need to shake the rear support bar slightly while fitting plates (P) over both plate (F) and flanges (G) as this will provide easier assembly.

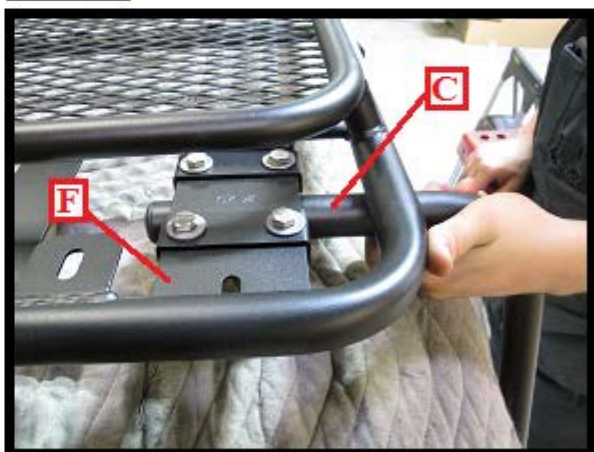
Fig. 46

After you have installed all four screws and nuts slide rear support bar (C) to the center of the slots in support plate (F) and fully tighten all screws securely. Apply the same procedure to the driver side rear support bar.

GOBI JEEP JK AEV BRUTE DOUBLE CAB ROOF RACK INSTALLATION INSTRUCTIONS

Fig. 47

Refer back to the pivot joints at the bottom of the rear support bars (C) as shown in Fig. 47 and fully tighten all screws both passenger and driver sides using a 3/4" socket and open end wrench.

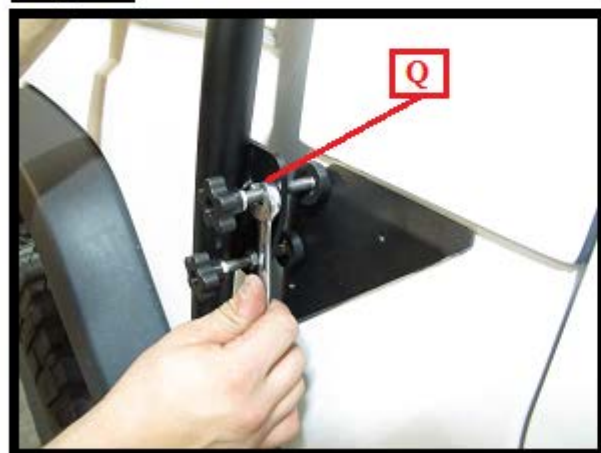
Fig. 49

After both driver and passenger side isolators have been adjusted tighten down jam nuts (Q) using a 1/2" open end wrench on all four isolators to prevent movement during transport.

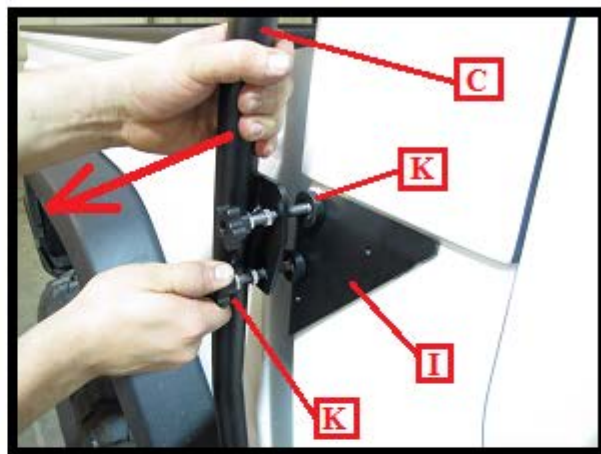
Fig. 48

Turn both passenger side isolators screws (K) as shown in Fig. 48 clockwise until they both make contact with triangular wear plate (I). Apply the same procedure to the driver side. Go back to the passenger side and while pulling out on rear support bar (C) in the direction of the red arrow turn both isolator screws in at least 2 full 360 degree turns to apply outward pressure to the rear bar. Apply the same procedure to the driver side.

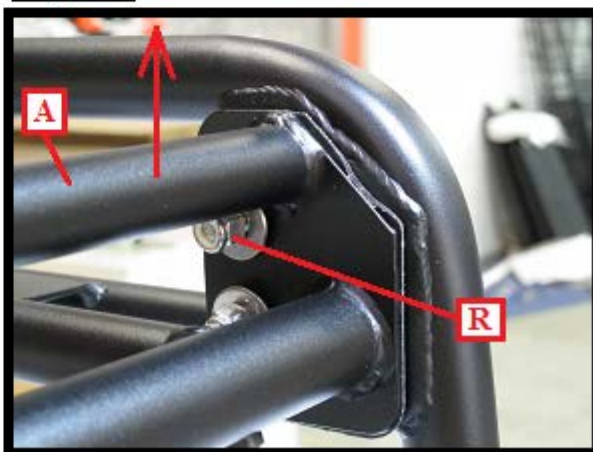
Fig. 50

Lift up roof rack (A) in direction of red arrow and fully tighten all four 3/8" nuts (R) using a 9/16" socket or open end wrench.

GOBI JEEP JK AEV BRUTE DOUBLE CAB ROOF RACK INSTALLATION INSTRUCTIONS



GOBI JK AEV BRUTE DOUBLE CAB ROOF RACK INSTALLATION COMPLETED