

GOBI JEEP JL 4 DOOR GLADIATOR REAR LADDER

PASSENGER AND DRIVER SIDE

INSTALLATION INSTRUCTIONS

Guidelines:

When using Load Carriers and Accessories, the user must understand the precautions. The points listed below will assist you in using the rack /carrier system and will encourage safety.

- For quality fits and safety, use only the recommended rack or accessory. Do not assume an accessory will fit, always check with dealer when obtaining new accessories. Use only approved accessories on load carriers. Using other brands will void your warranty.
- Make sure all knobs, bolts, screws, straps, and locks are firmly attached, tightened and locked before every trip. Knobs, bolts, screws, straps, and locks must be periodically inspected for signs of wear, corrosion, and fatigue. Check your load at stops during the trip to insure continued fastening security.
- Check local and state laws governing projection of objects beyond the width of a vehicle. **Be aware of the width and height of your cargo since low clearance branches, bridges, and parking garages can affect the load** All cargo will affect the vehicle's driving behavior. Never drive with any lock, knob, or rack in an open or unlocked position. All long loads such as, but not limited to sailboards, surfboards, kayaks, canoes, and lumber must be tied down front and rear to the bumpers or tow hooks, of the vehicle.
- Remove your rack accessories when they are not in use, before entering car washes, prior to taking in your vehicle for service, and whenever clearance may be an issue.
- All locks must be turned and moved periodically to insure smooth operation. Use graphite or similar dry lubricant to help this. Locks are designed to deter vandalism and theft. Remove valuable gear if your vehicle is unattended for an extended period. Place at least one key in the glove compartment.
- For safety to your vehicle and rack system, obey all posted speed limits and traffic cautions. Adapt your speed to the conditions of the road and the load being carried.
- Do not use load carriers and accessories for purposes other than those for which they were designed. Do not exceed their carrying capacity.
- Consult with your dealer if you have any questions regarding the operations and limits of this product. Review all instructions carefully.

READ ALL INSTRUCTIONS CAREFULLY PRIOR TO INSTALLATION

GOBI JEEP JL 4 DOOR GLADIATOR REAR LADDER

PASSENGER AND DRIVER SIDE

INSTALLATION INSTRUCTIONS

Included in kit

Letter	Description	Location	Quantity
A	GOBI JEEP JL 4 DOOR GLADIATOR REAR LADDER	Main box	1
B	HANGER PLATE	Strapped to Ladder	1
C	GOBI LADDER MOUNTING HARDWARE CONTENTS: 4- 5/16-18 x 1" SS Button head screws 8- M8 x 24 SS flat fender washers 4- 5/16" SS nylock nuts 1- 3/8-16 x 1" SS hex head screw 2- 3/8" SS flat washers 1- 3/8" SS nylock nut 1- Packet of Anti-seize lubricant	BAG #1 Hardware Box	1

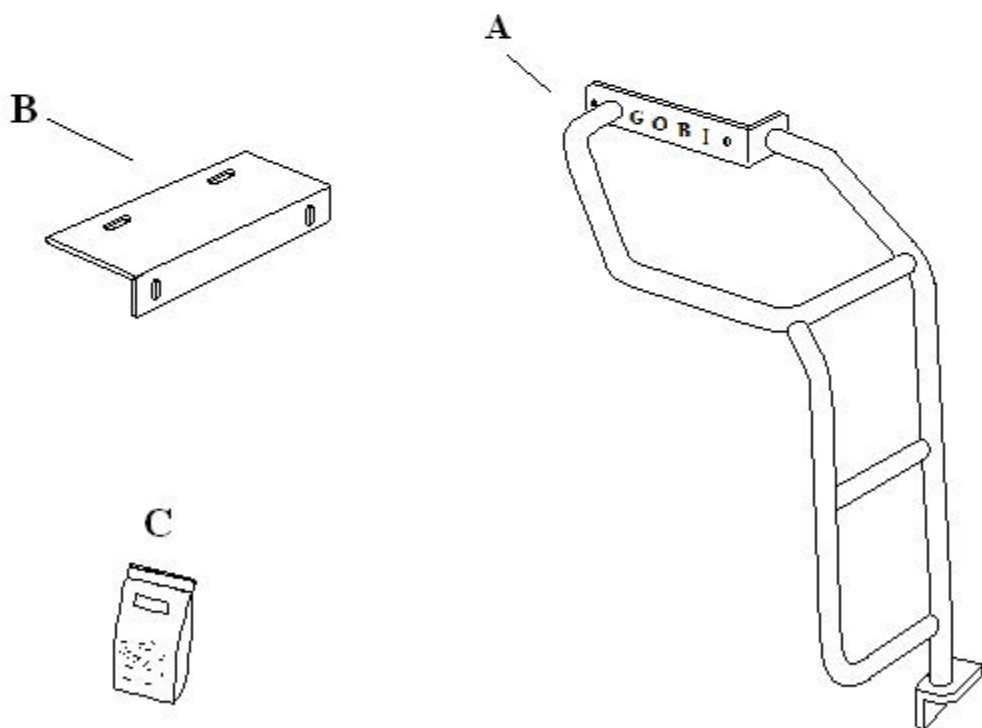

CAUTION: MAKE CERTAIN TO USE ANTI-SEIZE LUBRICANT ON ALL SCREWS PRIOR TO INSTALL

GOBI JEEP JL 4 DOOR GLADIATOR REAR LADDER

PASSENGER AND DRIVER SIDE

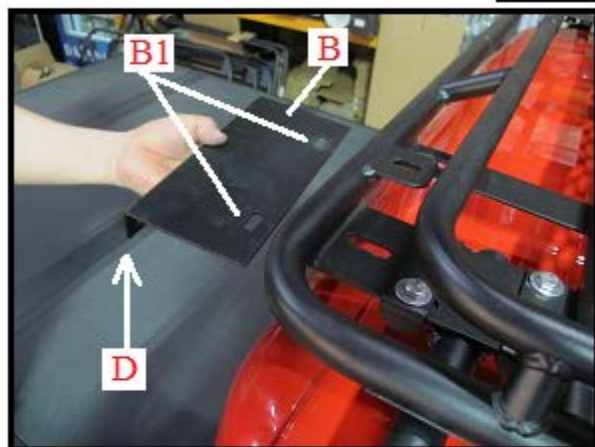
INSTALLATION INSTRUCTIONS**Fig. 1****Fig. 2**

Remove ladder hanger plate (B) shown in Fig. 1 and Fig. 2 from ladder packaging. Remove from Bag #1 2- 5/16- 18 x 1" button head screws, 4- M8 x 24 flat fender washers and 2- 5/16" nylock nuts (N) shown in Fig. 2. Position hanger plate (B) as shown in Fig. 1 so that the short angle (D) is facing down and to the rear. Slide hanger plate (B) under the rear passenger side roof rack (A) and align hanger plate slots (B1) shown in Fig. 1 with roof rack slots (B3) at the rear of the roof rack shown in Fig. 2 and Fig. 3. Install 1- 5/16-18 x 1" button head screw and 1- M8 x 24 flat washer (N) down through slots (B3) of the roof rack and into the (B1) hanger plate slots as shown in Fig. 2. From the underside thread on 1- M8 x 24 flat washer and 1- 5/16" nylock nut per screw and snug down in place using 1- 3/16" Allen wrench and 1- 1/2" box end wrench. Leave some play for adjustment. Apply the same procedure to the driver side.

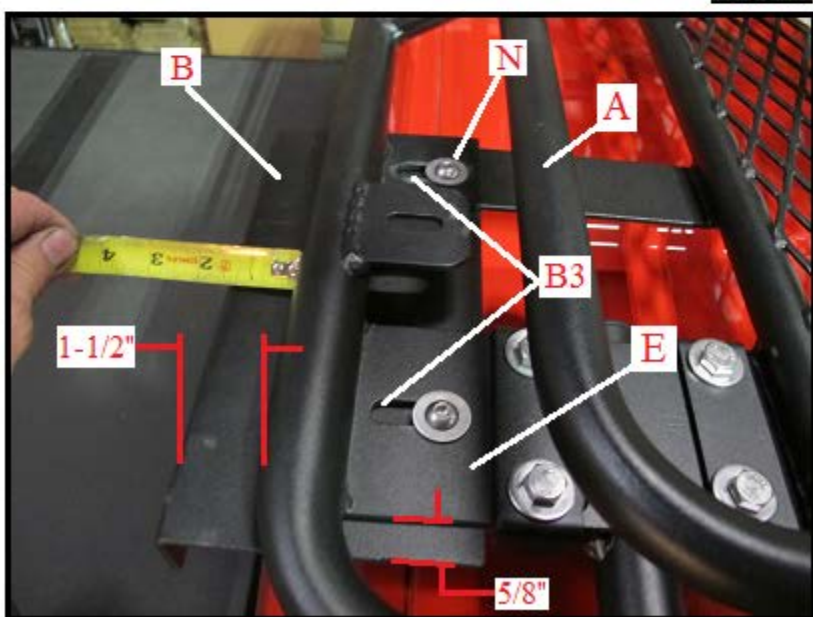
Fig. 3

Adjust hanger plate (B) so that the back of the hanger plate sits approximately 1-1/2" from the rear of roof rack as shown in Fig. 3, and 5/8" from the right of the roof rack support plate (E), also shown in Fig. 3. Then fully tighten both screws (N) in place.

GOBI JEEP JL 4 DOOR GLADIATOR REAR LADDER

PASSENGER AND DRIVER SIDE

INSTALLATION INSTRUCTIONS

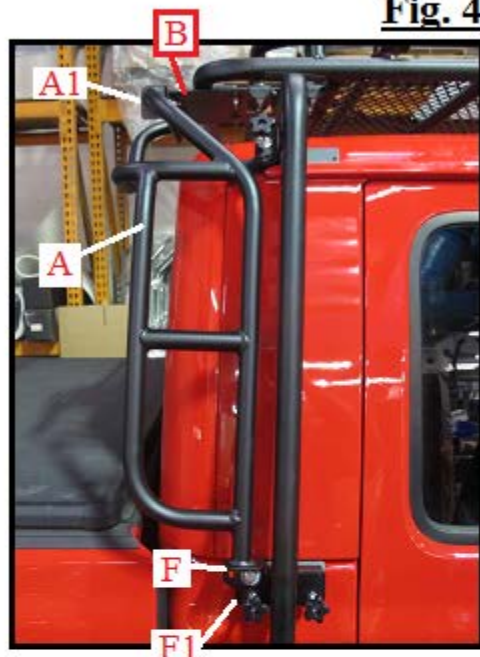
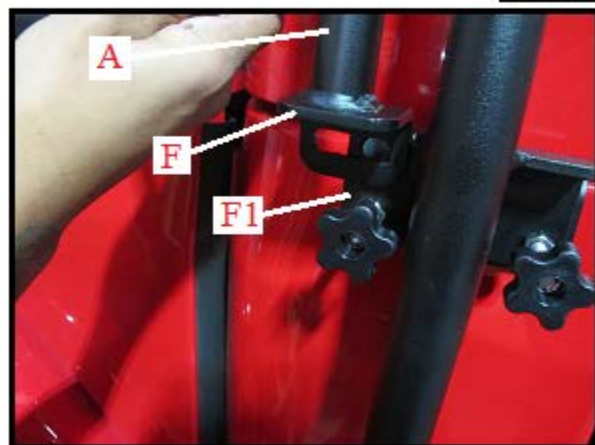
Fig. 4**Fig. 5**

Remove from Bag #1 1- 3/8-16 x 1" hex head screw, 2- 3/8" flat washers and 1- 3/8" nylock nut (N2) shown in Fig. 6. Place the upper portion (A1) of ladder (A) up against hanger plate (B) as shown in Fig. 4, and the lower flange (F) of ladder (A) onto the rear support bar flange (F1) as shown in Fig. 4, 5 and 6. Thread through 1- 3/8-16 x 1" hex head screw, 1- 3/8" flat washer (N2) through ladder flange (F) and through rear support bar flange (F1) as shown in Fig. 6. You may need help holding ladder (A) in place during this procedure.

Fig. 6

Thread 1- 3/8" flat washer and 1- 3/8" nylock nut onto screw (N2) on the back side of flange (F1) to hold ladder (A) in place. Snug down only at this time. Leave some play for adjustment.

GOBI JEEP JL 4 DOOR GLADIATOR REAR LADDER

PASSENGER AND DRIVER SIDE

INSTALLATION INSTRUCTIONS

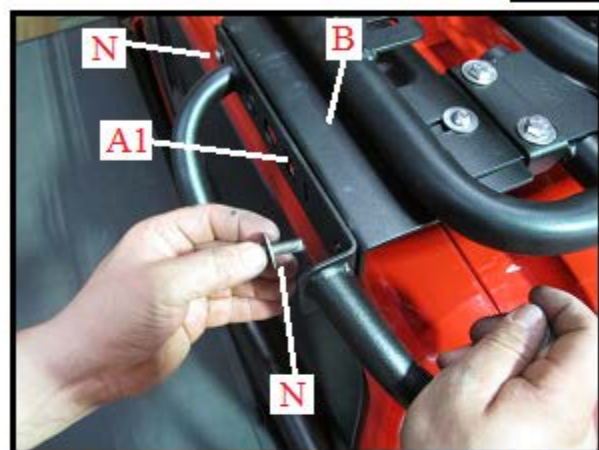
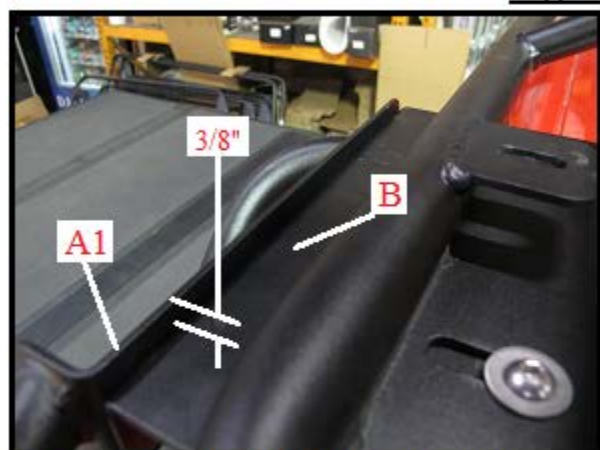
Fig. 7**Fig. 8**

Remove from Bag #1 2- 5/16-18 x 1" button head screws, 4- M8 x 24 flat fender washers and 2- 5/16" nylock nuts (N) shown in Fig. 7. Push in 1- 5/16-18 x 1" button head screw and 1- M8 x 24 flat washer through ladder upper bracket (A1) then into hanger plate (B) as shown in Fig. 7 both mounting holes. Thread onto the end of each screw (N) 1- M8 x 24 flat washers and 1- 5/16" nylock nut and snug down in place. Leave some play for adjustment.

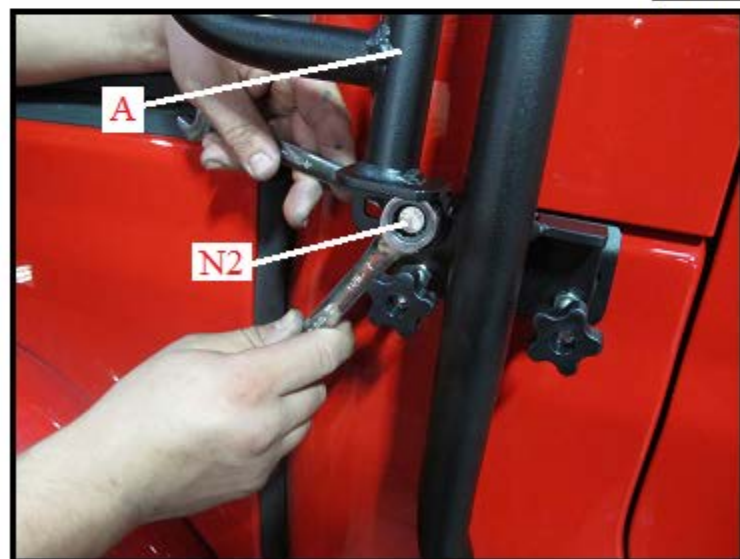
Fig. 9

Adjust ladder (A) so that upper ladder bracket (A1) sits approximately 1/4 to 3/8" above hanger plate (B) as shown in Fig. 8. Then fully tighten lower ladder screw (N2) using 2 9/16" box end wrenches as shown in Fig. 9. Fully tighten both upper screws (N) using a 3/16" Allen wrench and a 1/2" box end wrench as shown in Fig. 7. Apply the same procedure to the driver side.

GOBI JEEP JL 4 DOOR GLADIATOR REAR LADDER

PASSENGER AND DRIVER SIDE

INSTALLATION INSTRUCTIONS



INSTALLATION COMPLETED