

DROP

PROTECT WHAT MATTERS



Installation Manual

Single Tank Aeration Filter



INTRODUCTION

Thank You for Purchasing a DROP System!

We know you'll love your improved water quality, leak detection ability and water conservation benefits of your new DROP Water Management System from Chandler Systems. You'll soon wonder how you ever lived without it. Improving your water and protecting your home are just a few of the ways that the DROP Water Management System can improve your water system.

Be sure to check out the dropconnect.com website periodically for more information about additional DROP products as they are released.



833.BUY.DROP
(833.289.3767)



dropconnect.com

To further help you operate your new DROP system, we have provided you with many other resources for you to learn more. Feel free to call Chandler Systems when you need additional help. We also have many resources located on our website including instructional videos, and images.

DROP Connect is also active on various social media pages! Feel free to follow us for the most up to date information and news!



@dropconnect



Privacy Statement

For more information about privacy, visit our [privacy policy](https://dropconnect.com/sites/default/files/DROP-Privacy-Statement.pdf) online.
(<https://dropconnect.com/sites/default/files/DROP-Privacy-Statement.pdf>) online.

DROP Patents

For the most up-to-date list of patents, visit our patents on our website: <https://dropconnect.com/patents>.

FCC Compliance Statement:

https://dropconnect.com/sites/default/files/FCC_Compliance_Statement.pdf

Industry Canada Compliance Statement:

https://dropconnect.com/sites/default/files/Industry_Canada_Compliance_Statement.pdf

TABLE OF CONTENTS



Table of Contents

How to Use Your System

- System Operation Modes 4
- Additional Features 4

Installation Instructions

- Contents of Carton 6
- Precautions 7
- System Set Up 8

DROP Remote 13

Common Questions 14

CAUTION:

- Do not subject tank to any vacuum. If there is a possibility that a vacuum could occur, a vacuum breaker must be installed.
- Do not locate unit where the tank or any lines (including drain lines) will be subject to temperatures below freezing.
- If there is not at least 10' of line between the water heater inlet and the outlet of the closest softener/filter, an expansion tank should be installed.
- Do not use Vaseline or any petroleum-based lubricants on O-rings or rubber seals. Only use food-grade silicone lubricant.
- O-rings are lubricated before leaving the factory and do not require additional lubrication before installation in most cases.
- Do not use pipe dope or any sealant other than Teflon tape on threaded connections. Threads on the control valve and on the bypass nut connections do not require any tape because they use an O-ring seal. Tape is only required on the inlet/outlet adapter fittings and on the drain line fitting (if applicable).

HOW TO USE YOUR SYSTEM

Your DROP Water Management System was selected to address your specific water conditions. Your system uses advanced technology to deliver effective and efficient water treatment to protect your home plumbing system, deliver optimal water quality to you and your family, protect your home from leaks, and save you money, all while providing years of trouble-free operation.

Your system operates in two primary modes:

In Service: Your water is filtered as it passes through the filter media in your tank.

Regeneration: Your system cleans itself by backwashing the media to remove the filtered contaminants, and to reorient the media. It will then rinse to ensure the system is clean before returning to In Service Mode.

Note: Water to your home is not treated while in regeneration.

Additional Features You'll Find on Your DROP System

- **Advanced Electronic Control Valve:** Incorporates the latest filter control technology for optimal performance, efficiency and longevity.
- **Optical Sensor Technology:** Optical sensors control regeneration for precise performance.
- **High Flow Media Tank:** Your DROP system delivers the high flow rates required by today's demanding households.
- **Integrated By-pass Valve:** Allows you to take your system out of service if necessary.
- **Power Backup:** To continue to protect your home during power outage
- **Water Usage Monitoring** - DROP monitors your water usage and provides real time information including: current water flow, peak flow today, daily average of the last 30 days, as well as many useful historical charts.
- **Automatically integrates with other components on your DROP System** - DROP is a water management system that integrates all of the water related devices in your home including: water softeners, backwashing filters, leak detectors, sump pump alarms, and many more to come!
- **Convenient User Interface on your Smart Phone or Tablet**
- **LED Light Codes:** Alert you to system status at a glance.
- **Regeneration Status:** During a regeneration, the App will show the cycle and the time remaining in that cycle.
- **Regeneration Cycle Override:** During regeneration, you can force the system to move to another cycle step immediately by selecting a different cycle step in the App.



HOW TO USE YOUR SYSTEM



Manually Bypassing Your System: DROP's integrated bypass valve allows you to bypass your system should you ever wish to take it offline. To bypass your system, turn both handles until they are perpendicular to the system inlet / outlet. To place your system back online, turn both handles until they are parallel with the system inlet / outlet.

SERVICE

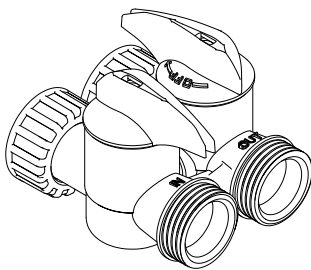

System In Service - Water to home is being treated

OFF

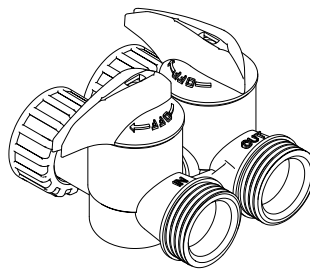

Water to home and filter is off

BYPASS

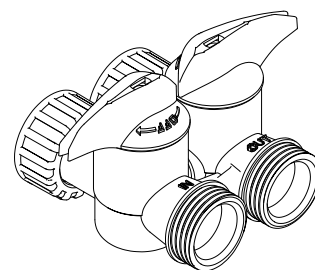

System Out of Service - Water to home is on and untreated

INSTALLATION INSTRUCTIONS

Contents of Carton

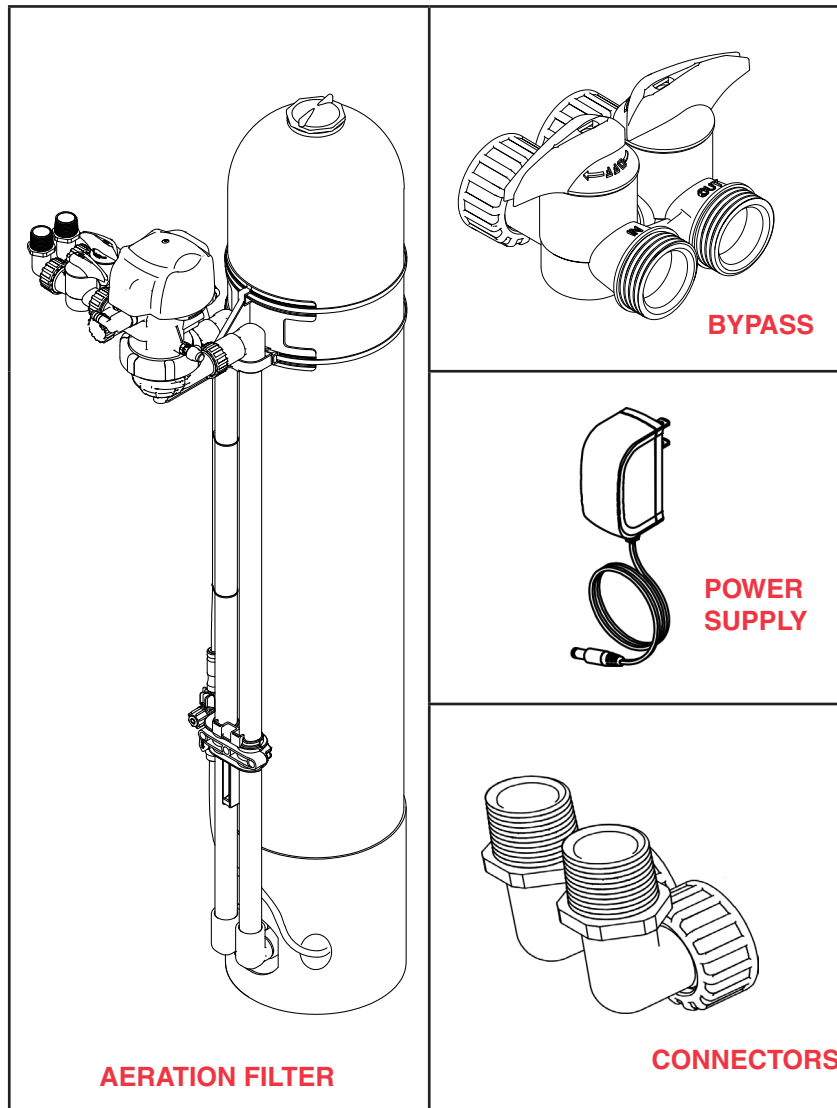

INSTALLATION INSTRUCTIONS



Precautions

1 Read



2 Ventilate

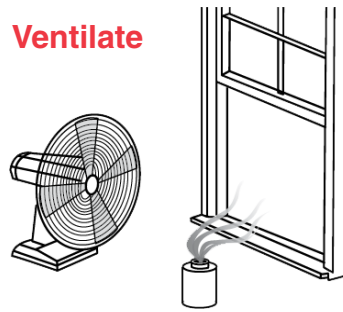

3 Use Eye Protection



4 Protect nearby materials when soldering.

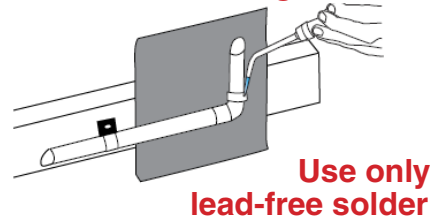

5 If existing plumbing is copper, install grounding strap before creating plumbing gaps.

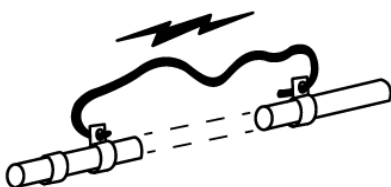

6 Don't reach.



INSTALLATION INSTRUCTIONS

System Setup

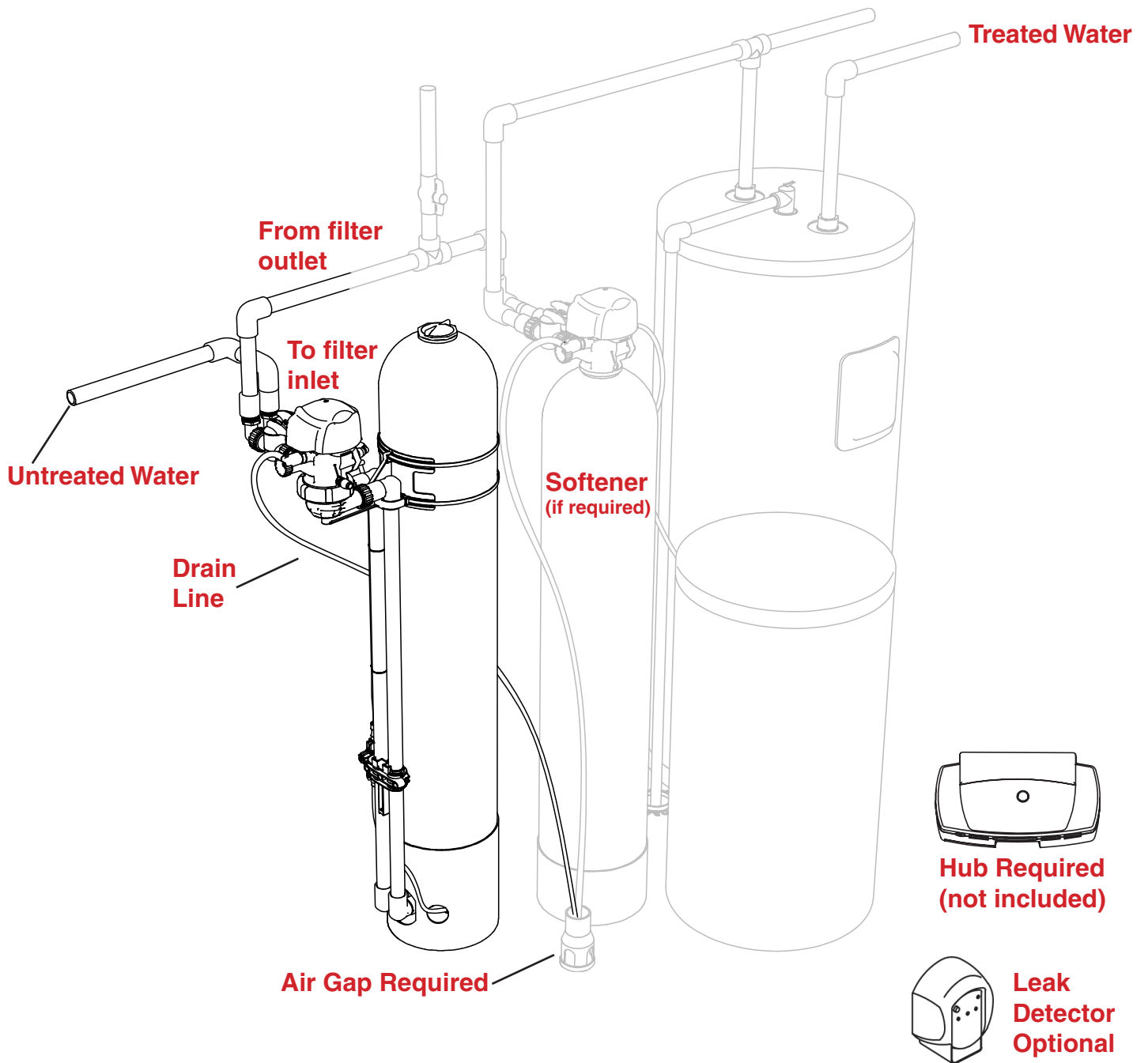

NOTE: Your installation may vary.
Follow all local plumbing codes.

INSTALLATION INSTRUCTIONS



System Setup

Unpack equipment and unscrew the black cap from the filter tank by turning counter-clockwise. Position the tank in the area where it is to be installed. This should be a hard level surface with access to plumbing, drain, and an electrical outlet. Use a garden hose or a bucket to fill the tank 1/3 full of water. Then add filter media to the tank. Be sure to plug the center distributor tube so that no media enters the tube. (Media funnel and distribution tube plug provided)

Note: 10x54" tanks require 1.5 cubic feet of filter media; 13x54" tanks require 2.5 cubic feet of media.

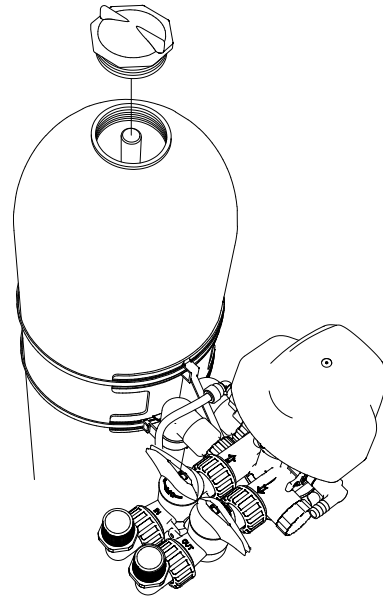

After media is added, remove the plug from the distributor tube, and fill the tank the rest of the way (up to the bottom of the tank threads) with water. This will allow the filter media to soak while the installation process is completed. Make sure that tank threads are clean and free of any media fines, and screw the control valve back onto the tank.

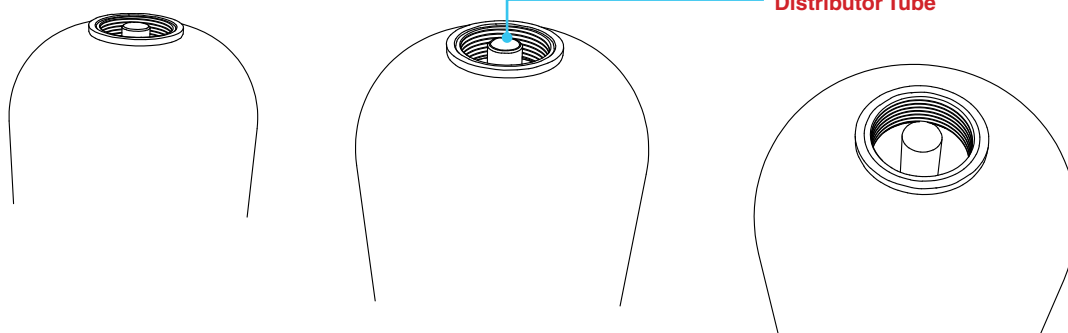

INSTALLATION INSTRUCTIONS

System Setup

Connect bypass valve and connectors to the control valve. Attach components by pushing the adapters together and tightening the nuts by hand until they feel snug.

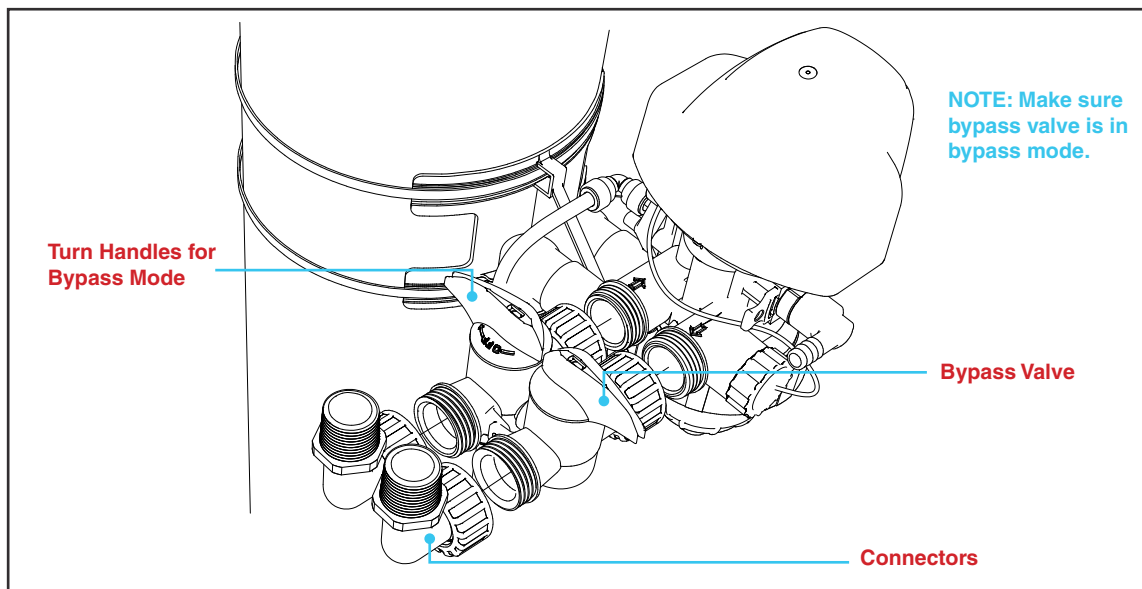

Turn off main water supply and open nearest cold faucet to relieve pressure. Cut water supply line, and connect plumbing to the inlet and outlet accordingly. Note: Inlet and outlet connections are 1" NPT. Additional piping and / or fittings may be necessary

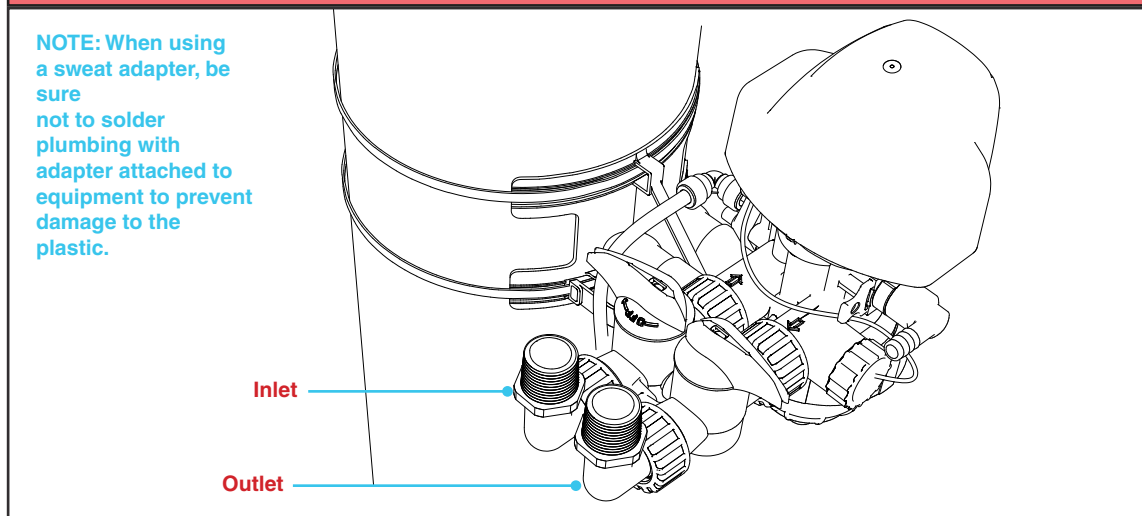

INSTALLATION INSTRUCTIONS



System Setup

Connect drain line to barbed drain adapter and run to appropriate discharge point. Use a 1/2" minimum pipe size for the drain. Use a 3/4" drain line for runs that exceed 20 feet. Make connection to a sanitary waste system through an air gap of 2 pipe diameters or 1", larger. Do not tee into any other drain lines.

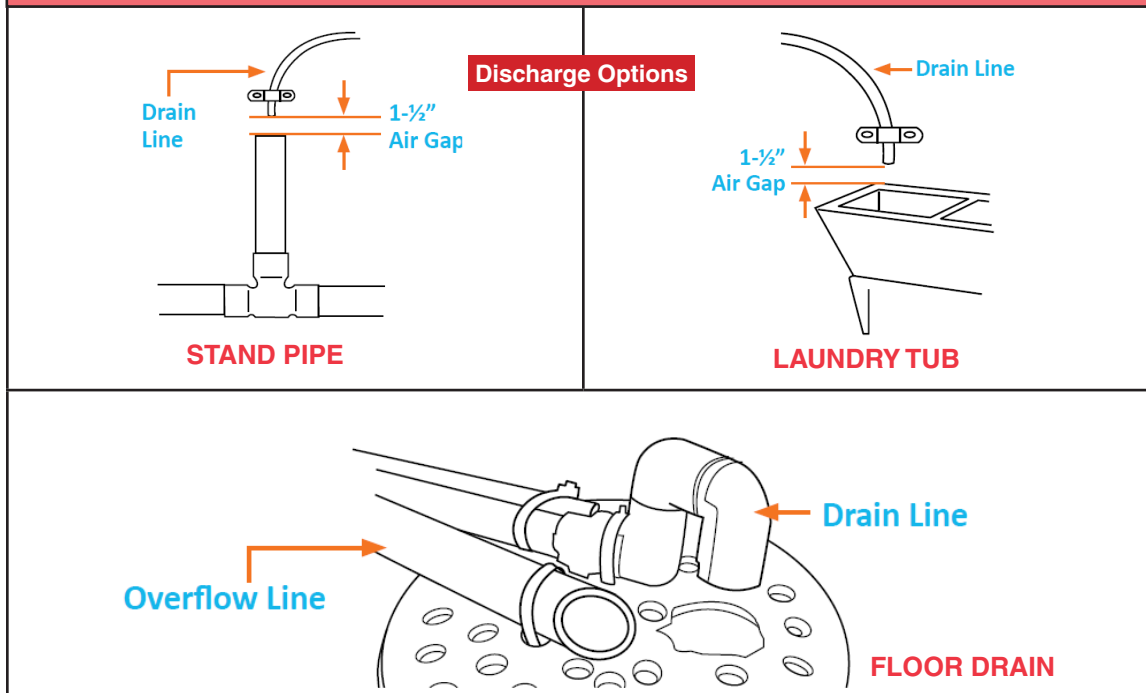

With the bypass valve still in bypass position, turn on the main water supply. Open a cold, treated water tap nearby and let run a few minutes or until the plumbing is free from foreign material (usually solder) that may have resulted from the installation. Once clean, close the water tap, open the bypass valve, and re-open the tap. Allow water to run until it is clear and free of media fines.

INSTALLATION INSTRUCTIONS

System Setup

This information is available in more detail in the USER GUIDE.

Place the DROP Hub in a central location in your home and plug it in. At this point, you can download the DROP Connect App on your device. When you open the app, it will walk you through the process of connecting to your Hub and connecting to WiFi, if desired.

Adding devices to the DROP system

Once you have connected to the Hub, you can use the app to connect your devices (softener, leak detectors, salt sensor, etc) to the Hub. First, unplug and remove any batteries from the DROP device you wish to add. Next, navigate to the 'System' (selection on left) > 'Advanced' (selection at top) page in the app and enable the 'Add Device Components' mode. The hub will enter a state where it will accept new connections. Plug in the device(s) that you are adding, or for a leak detector, simply install the batteries. After the device has joined the DROP network you will see it added to the "Manage Device Components" table, you can then disable the 'Add Device Components' mode or simply wait for it to automatically disable.

When a new device is added to the system, you can rename that device by choosing "System" on the left navigation menu and scrolling to the bottom of the System Status page. Devices such as the softener and salt sensor will already be labeled appropriately, but in the case of leak detectors, each individual leak detector will simply be labeled "leak detector." In this case, you can rename each leak detector according to where you put them, such as "water heater" or "kitchen sink."

System Settings

The first settings that should be reviewed are the Regeneration Time and System Water Source. Choose "System" on the left navigation menu and it will bring you to the System Status page, where these settings can be adjusted if needed.

Regeneration Time

This setting controls the time of day when the system will begin to regenerate. While a softener or filter is in its regeneration cycle, any water used in the house will not be treated. Therefore, it is important to choose a time of day where water use is least likely. It is also important to understand how long the regeneration of your system will take. For a filter with standard settings it will take approximately 30 minutes. Some DROP installations will require multiple filters and/or softeners. These stages can require regeneration on the same day and would occur one after the other starting at the regeneration time, so you should select a regeneration start time that would take these times into consideration along with your water usage schedule.

SSSSS S/F SSSSSSSSSS

The system water source setting is used by the DROP system to know how to respond to power outages. It can be set to Private Well or Municipal Supply. If your water supply is not one of these choices, if your water supply is dependent on power to be available (i.e. it is supplied by an electric pump) set it to Private Well, otherwise set it to Municipal Supply.

THE DROP REMOTE



Every DROPLET System sold as a bundle comes with one DROPLET Remote.

In addition to acting as a DROPLET Link mesh network extender, the DROPLET Remote has additional features:

At a glance the remote can provide the status of your water system through color codes.

Color codes for normal operation

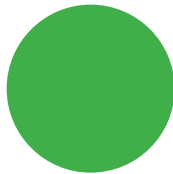

Water is in Service

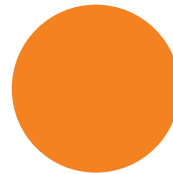

Water is Shutoff

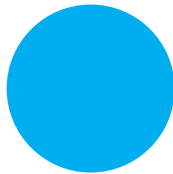

Slow blinking indicates you have a notification in your DROPLET App that has not been seen

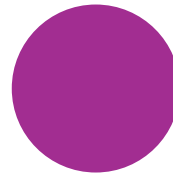

Flashes indicate that the DROPLET Remote is communicating with other devices

To turn off water in your home, place your finger on the water DROPLET button for about 2 seconds. Once the lights turn orange, remove your finger.

If your system is in the Shutoff mode and you would like to turn your water back on, place your finger on the DROPLET button for about 2 seconds. When it turns green, remove your finger and, your water will turn back on.

More details about the DROPLET Remote can be found in the DROPLET User Guide.

Note: This equipment has been tested and found to comply with the limits for a Class B digital device, pursuant to part 15 of the FCC Rules. These limits are designed to provide reasonable protection against harmful interference in a residential installation. This equipment generates, uses and can radiate radio frequency energy and, if not installed and used in accordance with the instructions, may cause harmful interference to radio communications. However, there is no guarantee that interference will not occur in a particular installation. If this equipment does cause harmful interference to radio or television reception, which can be determined by turning the equipment off and on, the user is encouraged to try to correct the interference by one or more of the following measures:

- Reorient or relocate the receiving antenna.
- Increase the separation between the equipment and receiver.
- Connect the equipment into an outlet on a circuit different from that to which the receiver is connected.
- Consult the dealer or an experienced radio/TV technician for help.

This product may be covered by one or more patents. (<https://dropconnect.com/patents>)

Chandler Systems Inc.
710 Orange St.
Ashland, OH 44805

P. 1 833 BUY-DROP
www.dropconnect.com

COMMON QUESTIONS



Extra Cycle / Manual Regeneration: Should you ever need to initiate a manual regeneration due to unexpected higher water use, use the **Regenerate Now** button in the App.

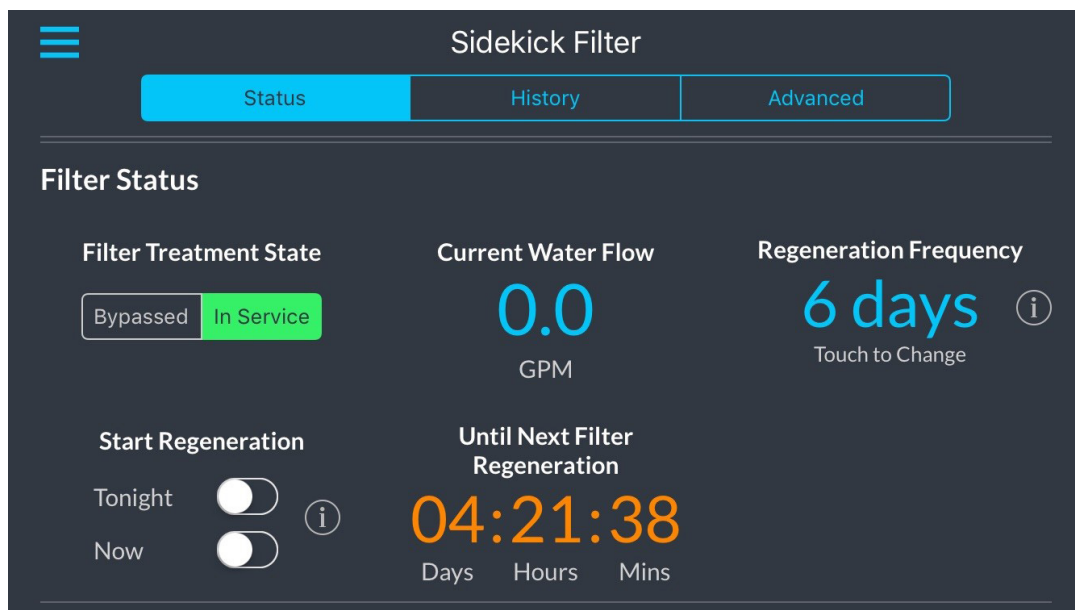

DEVICES > FILTER > STATUS

There has been a drop in my home's water pressure. What can be the cause? A reduction in your home's water pressure can indicate that it is time to change your prefilter (if one is being used) or that your filter needs to backwash more often. Try increasing your backwash frequency, and follow the steps above to initiate a regeneration. If you do not have a prefilter with your system and if backwashing the filter has no effect, contact your authorized DROP Water Management System representative.

My water doesn't seem filtered. How can I be sure that my system is regenerating properly? Be sure that the water supply to the filter is not bypassed. Follow the instructions in the "Extra Cycle / Manual Regeneration" above to manually backwash the filter. If the unit does not advance through to the next regeneration automatically, please contact your DROP Water Management System representative for further assistance.

If at any time you feel your system is not operating properly, bypass the system and call your authorized DROP Water Management System representative.

