

# FenSens<sup>™</sup>

## Smart HD Solar

Wireless Backup Camera



Important, retain for future reference:  
Read carefully

## TABLE OF CONTENT

Introduction	01
Package Contents	02
Product Specifications	03
Installation Guide	04
Settings and Operation	07
Troubleshooting and FAQs	14
Warranty	18

## INTRODUCTION

Please read all of the installation instructions carefully before installing the product. Improper installation will void manufacturer's warranty. The installation instructions do not apply to all types of vehicles, and are written as guidelines to assist in installing the system.

Consult an experienced technician if you are not comfortable installing the product. You can also contact FenSens at **FenSens.com** to speak to one of our installation specialists if you have any specific questions regarding the Smart HD Solar Wireless Backup Camera.

**BEFORE using the Smart HD Solar Wireless Backup Camera, please read the safety information provided in this user manual. ALWAYS use the product as outlined in this user manual.**

Please make sure to read and understand all local laws and regulations regarding cameras and their use in a vehicle. Laws vary by state.

## PRODUCT CONTENTS

1. Smart HD Solar Wireless Backup Camera
2. 2 x Two Way Mounting Tab (Optional)
3. 33" USB Cable for Charge License Plate Backup Camera Power
4. 2 x Mounting Screw & Nut (Optional)
5. 2 x License Plate Machine Screw (Optional)  
2 x License Plate Self-Tapping Screw (Optional)
6. TAP Button

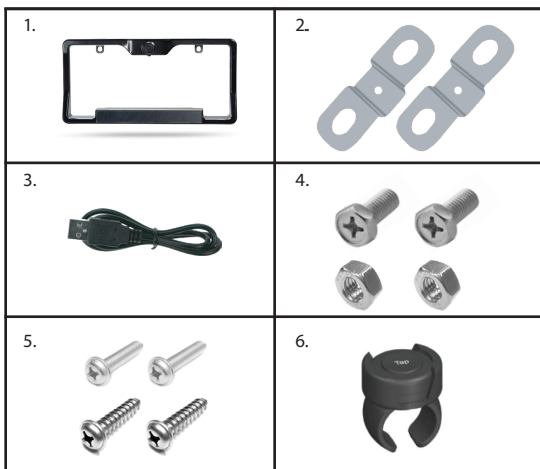

## PRODUCT SPECIFICATIONS

- |                             |  |
|-----------------------------|--|
| 1. Frequency:               | 2.4GHz   |
| 2. Operating Temperature:   | 14°F~122°F (-10°C~50°C)                                    |
| 3. Camera Water Resistance: | IP65 rating  |
| 4. Battery Capacity:        | 2200mAh  |
| 5. Maximum Signal Range:    | 33 feet/10 meters<br>(without interference or obstruction) |

## SETTING UP THE MOBILE APP

**\*Make sure to charge your device with the provided USB cord for at least 2-3 hours to give it a full charge before installing on your vehicle. Always setup and test the device and app first before mounting on your car.**

1. Download the app on the Google Play or Apple iTunes App Store.
2. Select whether the device will be mounted on the front or back of your vehicle. Select only one option for now.
3. Make sure your smartphone Bluetooth and WiFi settings are turned on, then pair your smartphone with the FenSens device and the QuickLaunch button. Make sure you accept all the permissions required by the app. On iOS the TAP QuickLaunch feature work best if you have the app running in the background and your location settings turned to "Always On" for FenSens. Lastly, please allow push notifications form our app.
4. Launch FenSens anytime you want to use it by simply opening the app, hitting the camera icon within the app's navigation bar, or tapping the included QuickLaunch button.

# Smart HD Solar Wireless Backup Camera

## A) STANDARD INSTALLATION



1. Unscrew your license plate.

2. Secure the Smart HD Solar Wireless Backup Camera and license plate with license plate with screws back onto the rear of your vehicle.

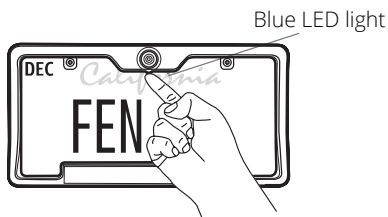

3. Push and hold the power button of the Smart HD Solar Wireless Backup Camera for 1 second, the blue LED light will flash 2 times.

\*Please follow your local laws and regulations regarding constant monitoring while driving. It is recommended that you glance at the image only when in reverse, and use as an aid. Do not rely solely on the camera view to back up.

## B) LOWERING INSTALLATION- FOR VEHICLES WITH TRUNK OR HATCH DOOR RELEASE (This allows more clearance for finger tips to release door latch)

1. Unscrew and remove your license plate.

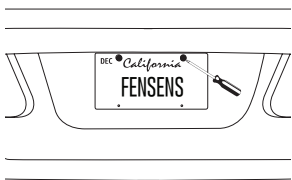

3. Install the license plate onto the Smart HD Solar Wireless Backup Camera with the Mounting Screws & Nuts.

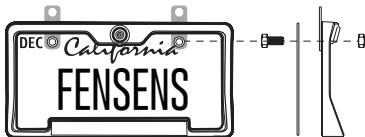

- 2a. Unscrew and detach the original Mounting Tabs from the back of the Smart HD Solar Wireless Backup Camera.

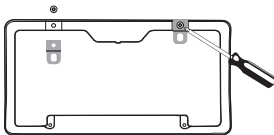

- 2b. Install the Two Way Mounting Tabs onto the Smart HD Solar Wireless Backup Camera.

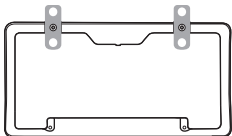

4. Secure the Smart HD Solar Wireless Backup Camera with the license plate back onto the rear of your vehicle.

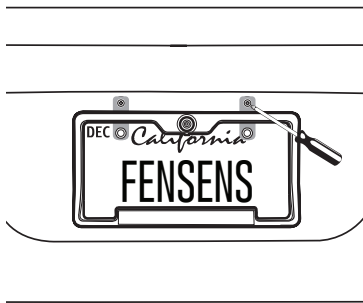

## C) RAISED INSTALLATION – FOR TRUCKS & SUV WITH STEP BUMPERS (This will raise the camera frame out of the cavity of the step bumper)

1. Unscrew and remove your license plate.



2. Install the Two Way Mounting Tabs using original Plates Screws and Mounting Screws.

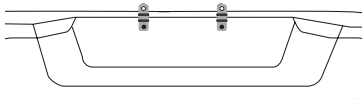

3. Finally, install the Smart HD Solar Wireless Backup Camera and license plate onto the rear of your vehicle and tighten the Mounting Nuts with a wrench.

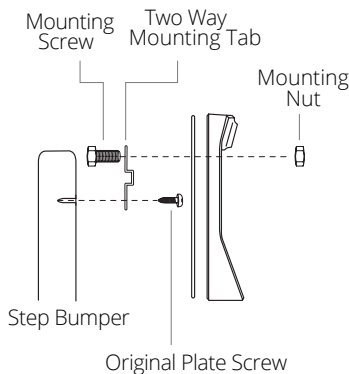

**Warning:** Lower tailgate on pickup trucks slowly and check for minimum  $\frac{1}{4}$  inch clearance between gate and top of camera frame. This check is because some bumpers are installed higher than others.



# SETTING UP THE CAMERA IN THE APP

There are 2 ways to start setting up the camera. One is from the settings menu under "Manage Devices" > "Cameras" > Blue "+" sign. The other is by navigating to the camera icon in your app navigation bar.

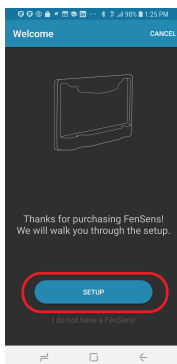
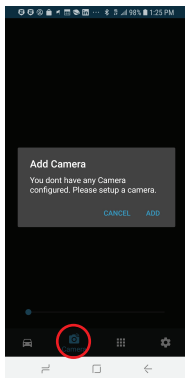

Click "**Setup**" Button

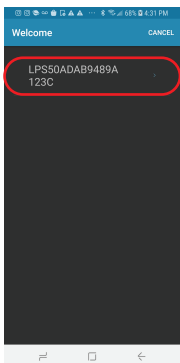

Select the **LPXXX Bluetooth Device**

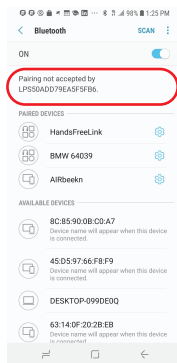

Connect with the Smart Wireless Camera by searching for the "**LPXXX**" in your Bluetooth settings. Please note it may say "**Pairing Rejected**", but if you click on it and it shows up here, then the connection is actually successful.

# SETTING UP THE CAMERA IN THE APP

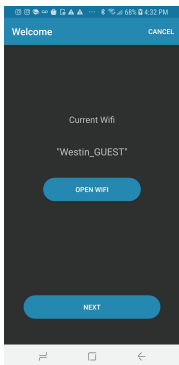

It should now say **"Type S"** or **"Unknown"** under WiFi Settings. If it shows a different network, click **"Open Wifi"** to manually switch to the Type S network. After it updates, press **"Next"**

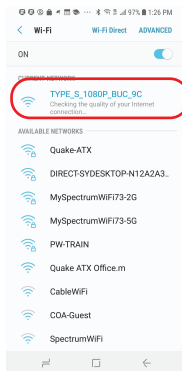

Connect with the Smart Wireless Camera WiFi network by looking for **"Type\_S\_1080p\_BUC"** in your WiFi settings. Once again, it will show up as **"Checking for internet connection"** but the connection should actually be complete if it shows up here.

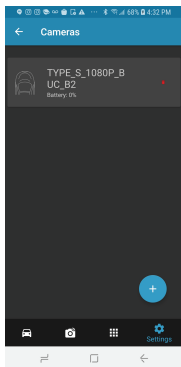

If the camera is added successfully it should show up in your list on **manage devices > cameras**

## USING THE LIVE CAMERA FEED

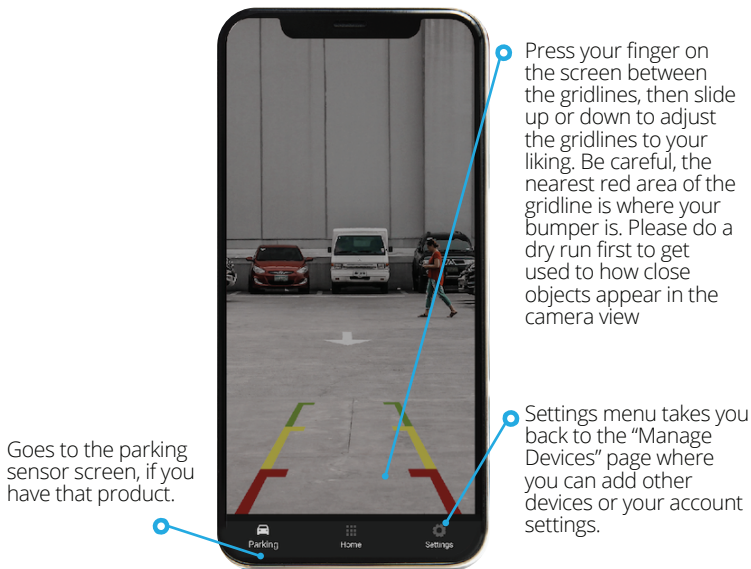

### Launching the Camera Feed:

The camera feed will launch in 1 of 2 ways

1. Hit the TAP QuickLaunch Button (make sure your settings are correct) and the app should open to the camera page (iOS receives push notification)
2. Open the FenSens app and navigate to the "Camera" icon on the navigation bar or from the "Home Menu"

**\*Please note camera may shut off after 120 seconds for battery saving reasons, simply close and relaunch the application. While the app will automatically try to connect to the camera WiFi, the live camera feed always launches faster if you manually connect to the Type S WiFi network.**

# SETTING UP MORE APPS AND DEVICES ON THE “HOME SCREEN”

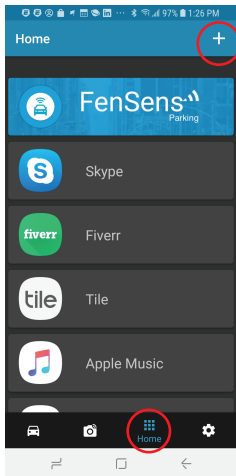

Click the “+” sign in the upper right to add any app from your phone to the home screen

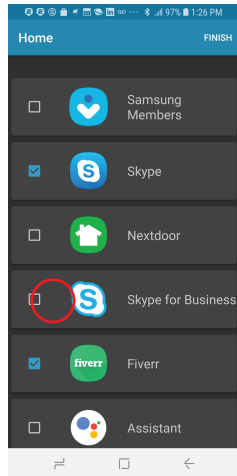

At anytime from within the app you can hit the “Home” icon to launch the “Home Screen”. From here you can access other helpful apps while driving such as music streaming apps, maps, etc.

Select the apps you want on the home screen by clicking on the check box. Once you see a check it is selected, you can deselect by click on the box to remove the check mark. This app will now be easily accessible on your “Home Screen” and in the future (Q1 2020) you will be able to access without even touching your phone (just use the TAP button).

## MAGNETIC CAR MOUNT INSTALLATION

There are three ways to apply the adhesive metal plate (1a). Select the most suitable one according to the size of your smartphone and install it on the back of your device, your phone case (1b), or between the device and the phone case. Do not forget to remove the adhesive if necessary.

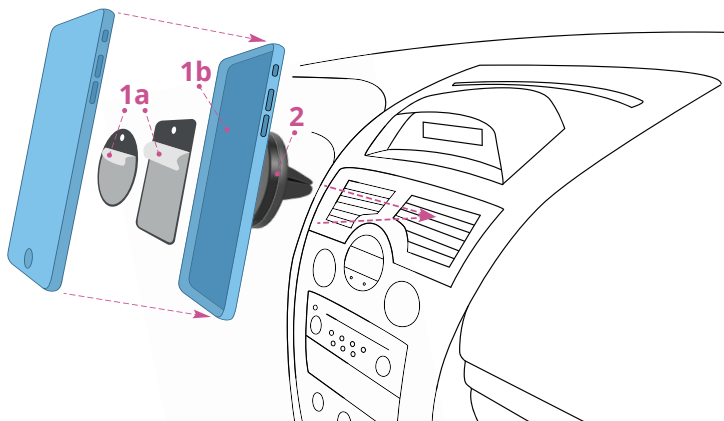

Insert next the car magnet mount (2) into the air vent of the car and put the phone over it. After installation, you can rotate your smartphone and swivel your display with your preference. The metal plate might not be compatible with any Qi wireless charging product.

## ADDING TAP QUICKLAUNCH BUTTON

To make sure your TAP quicklaunch button works properly, do not hit the button before attempting to pair, this will put it into advertising mode. You can, however, hold the button down for 5 seconds to put the button into Bluetooth pairing mode. If you do not hit the button, the button should be available within 1 minute by going to Settings > Manage Devices > TAP > Add TAP > Select The TAP Button By Name To Highlight It > Connect TAP

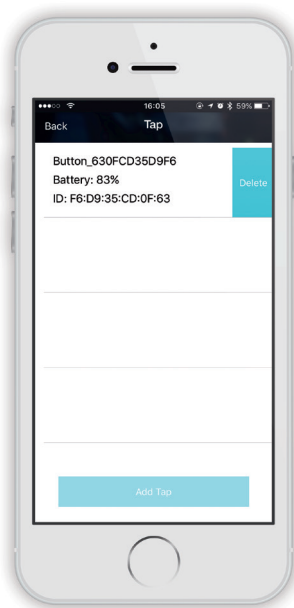
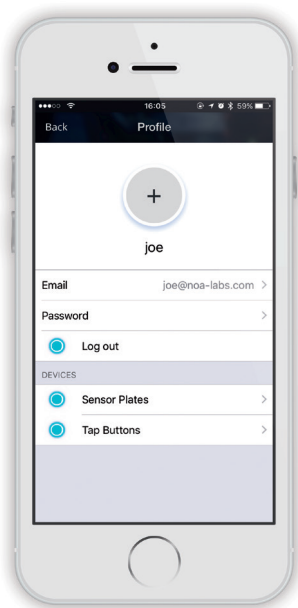

Next make sure your Bluetooth setting is on in your phone and FenSens has “Always On” permissions from your location settings and also allows push notifications from your phone’s settings. On Android, if you are near the button and device, if you hit the TAP button it will open the app automatically if you do not have screen lock on. If you are on iOS you should get a push notification when you get near your car, hit the push notification to launch the app and uses the sensors. Lastly, on iOS, if you use the TAP button it’s best to have the FenSens app running in your phone’s background and the above mentioned permissions. Tapping the button will send a push notification on your phone that launches the app automatically if it pressed. If the APP is not in the background hit the TAP button once to pull it into the foreground, wait one second, then hit the TAP button again to receive the push notification to launch the app.

Mount the include TAP QuickLaunch button on your steering wheel or carefully take it out of the button holder by pinching the ring of the button holder, then using two fingers to gently pull out the button.

This button can be placed anywhere in the vehicle with the included 3M tape from the screw kit.

## TROUBLESHOOTING & FAQ

**While the app will automatically try to connect to the camera WiFi, the live camera feed always launches faster if you manually connect to the Type S WiFi network:**

### 1. Unable to pair with smartphone or tablet

If you have yet to follow the setup instructions, please walk through the setup process to pair your FenSens device with your smartphone. Due to software limitations it may show up that the Bluetooth or WiFi connection is rejected, but this is usually not the case, our app will prompt you if you need to reconnect, otherwise navigate to the live camera viewing page after pairing with the camera WiFi and Bluetooth and it should be streaming video.

### 2. FenSens device keeps dropping signal

If your device signal keeps dropping, please close out of the app and open it up again or press the included Tap launcher button to auto-launch.

### 3. Lost or damaged accessories

If you have lost or damaged one of the included accessories, please contact [info@FenSens.com](mailto:info@FenSens.com). The custom security screwdriver will require a replacement if it becomes lost, but the other screws can be easily removed using a standard screwdriver kit.

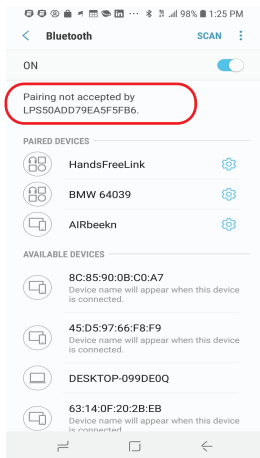



#### **4. How Do You Prevent Theft?**

FenSens comes with a set of security screws. FenSens owners are the only ones with the unique (included) screwdriver that can take it off the license plate.

#### **5. How Long Is The Battery Life?**

The battery lasts upwards of a year or more with adequate amount of sunshine per day. If you receive at least 2+ hours of daylight per day and only use the device 5 minutes or less per day (average use), then it should easily last over a year. Quality of daylight, initial charge, the amount of time in use, and other factors can shorten the battery life, however. If your device runs out of battery, you'll know when you can't find the Bluetooth or WiFi signal for it, if that's the case it's time to recharge the device with the Micro USB port.

#### **6. Do I Have To Do Anything After Installing To Use It?**

The included QuickLaunch button launches Android application instantly or sends a push notification to open the app if you are using iOS. The Android app starts providing you feedback without you having to do anything and the iOS app works by simply clicking the push notification you receive.

#### **7. My Device Takes Too Long To Connect**

We have found this is typically because the user attempts to turn on their Bluetooth/WiFi settings while in the car. If the user turns off Bluetooth/WiFi and then goes in the car, turns on the Bluetooth/WiFi again, and opens the APP when they want to park, it might need a few seconds to connect the sensor device. If the signal is not strong in the car, it might need more time to connect.

We suggest to turn on Bluetooth/WiFi all the time which doesn't use much battery at all from the phone, the APP can then connect to device when the user gets close to car and the app will connect much more quickly.

Our device has a powerful antennae, but not every phone does, so it takes a bit to connect usually on the smartphone side. Avoid this by having your Bluetooth/WiFi turned on already.

## **8. What Is The Effective Range Or Object Detection Capabilities?**

While FenSens helps assist in safe parking, please pause for one second, look behind to see if your path is clear, then move. FenSens can usually works on vehicles 30 feet or less, however we would recommend it mostly for cars less than 20 feet to have the best possible experience.

## **9. What Type Of Vehicles Does It Work For?**

FenSens is perfect for all consumer and commercial fleet vehicles not exceeding 9.14m in length.

## **10. The TAP Button And Auto-Launching The App**

The TAP button automatically launches your app on Android and sends you a push notification on iOS that you can use to tap (the notification) and launch the iOS app on your phone instantly. Pair your TAP button from the “Manage Devices” section, which you can access from the settings page in the app itself. **DO NOT CLICK THE TAP BUTTON BEFORE LAUNCHING** as this will put the button in an advertising mode and it will not be discoverable by your app. If you do hit the button, you will have to wait more than one minute before you can establish pairing again. Add the TAP button from the “Manage Devices” page where it says “TAP Buttons”, then click “Add TAP Button” to look for a nearby button you can pair with and use to auto-launch the app going forward.

## **11. How Do I Use The Included Smartphone Mount?**

Place the air vent phone mount on your air vent in your car. Place the magnetic sticker on your phone or behind a smartphone case, then place your smartphone on the air vent smartphone holder to safely use your app hands-free while driving. Use the included TAP QuickLaunch button to auto-launch the app without touching your phone.

## **12. My TAP Doesn't Launch**

For any button related issues, please see above FAQ's and make sure to check all permissions in APP. You should also turn on Location Services on your phone as our beacon uses this to determine if you are close to the device and send a push notification.

### **13. Can I Take The Button Out Of The Holder?**

Yes, the button is fully removable from the holder. Simply pinch the holder back to loosen the button, then use both fingers to carefully pluck the button from the button holder. Use the included 3M tape that came with your screw kit to place the button anywhere you want in the vehicle.

### **14. How Do I Use The TAP Button?**

The TAP button launches the app automatically on Android and will send you a push notification on iOS. For best operability, please make sure you accept all permissions the app asks for and for iOS have the app running in the background. One tap on Android will launch the parking sensor page, another tap will take you out of the parking page to the home screen. A long hold of 4 seconds on Android or iOS will put the button into pairing mode if you are having trouble pairing with the button.

### **15. TAP QuickLaunch Isn't Working On IOS**

Make sure you accept all the necessary permissions in the app and set your Location settings on your phone to allow FenSens to use location "Always", not while using. The TAP button performs best when you have the FenSens app on in the background of your phone.

If you are having issues pairing, then make sure to do a 5 second hold on the button to put the button in Bluetooth pairing mode. The button should appear available to pair with under Settings > Manage Devices > Tapp > Add Tap > Connect.

### **16. I Don't Want To Mount The TAP Button On My Steering Wheel**

The TAP button can be taken out of its included holder and placed anywhere in the vehicle. Carefully pinch the bottom ring of the button holder to loosen the top, then carefully pop the button out of the holder. Use the included 3M tape from the screw kit to mount the button anywhere you would like in the car.

# WARRANTY

## **One Year Limited Hardware Warranty**

FenSens, Inc hereby warrants to the customer of record that this product is in good-working condition and free from defects in material or workmanship under normal use for a duration of 1 year after the date of purchase. The product has been tested to meet the highest quality standards in each testing category. In the unlikely event that the product proves to be defective, FenSens will repair or replace the product free of charge. If replacement is required and if FenSens, Inc then no longer carries the same product, then FenSens, Inc reserves the right to substitute the product with a replacement product of like quality and size, suitable for the intended use.

This warranty is limited to repair or replacement of the mentioned product only, is non-transferable and does not extend to any product damaged by misuse, natural disasters or any other circumstances beyond FenSens, Inc's control. The warranty does not cover or provide for the reimbursement or payment of incidental or consequential damage resulting from breach of the limited warranty described above. Except for the limited warranty described above, we offer no other warranties expressed or implied. Aside from limited warranty expressly contained herein, we hereby disclaim any and all warranties, including without limitation any implied warranties of merchantability, suitability or fitness for a particular purpose.

If your product is not functioning or you have any concerns, please contact FenSens Support before returning the product to us.

### **Online Support / Contact Us**

Please visit us at <http://FenSens.com> for support information. You may also reach us with the contact information provided below.

Online: <http://FenSens.com>

Email: [info@FenSens.com](mailto:info@FenSens.com)

