



RAM[®]
MOUNTS

Paddlesports



About RAM® Mounts

RAM® Mounts manufactures rugged and versatile marine mounting systems for cameras, fishfinders, phones, rod holders, tablets, and other mobile devices that can be attached nearly anywhere. Unlike other mounts on the market, RAM® allows you to mount items where you need them most. The unique design of the RAM® Mounts system provides quick installation, adjustability, strength, vibration dampening, and durability—all at a low cost. Backed by a lifetime warranty, RAM® uses powder-coated marine-grade aluminum with lightweight and high-strength composites, stainless steel hardware, and rubber balls.

The RAM® Difference

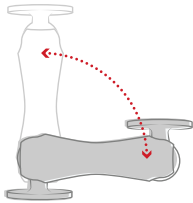

Premium Design

The rubber ball and socket design of our mounting systems offers a secure hold, with near-infinite adjustability and vibration dampening for the most demanding environments. With thousands of components trusted by users around the world, we've been able to design and develop mounting solutions that consumers and companies previously only dreamed were possible.

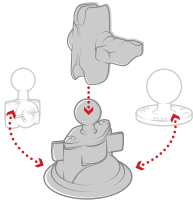

Customizable

Take your phone mount from your truck to your boat, or mix and match components to create your ideal mount. Because of the modularity of the RAM® system, you can customize your solution to fit your specific needs in almost any application.

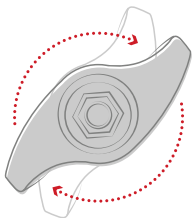

Quality Materials

A premium design deserves the highest quality materials available, from rubber and stainless steel to high-strength composites and marine-grade aluminum. Our facilities—including powder coating, die casting, rubber injection molding, and shock and vibration testing—help us deliver on this promise to bring you inventive mounting solutions.

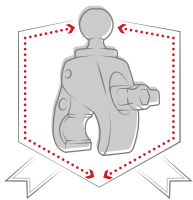

Lifetime Warranty

It's simple. Our reputation as the leader of premier mounting systems means if we build it, then we guarantee it. We're confident in the quality of our products, and with our warranty, you can be too. Learn more about our lifetime warranty at rammount.com/warranty.

Partner with RAM® Mounts

Here at RAM® Mounts, we believe that unfathomable things are possible with ingenuity. With a portfolio of over 5,000 SKUs paired with innovative engineers and in-house product experts, we have the tools and expertise needed to create solutions that you didn't know were possible. We have the ability to solve your mounting challenges quickly, efficiently and cost effectively.

No matter your company's size, you can trust RAM® Mounts to deliver ingenious solutions that do exactly what you need them to do on the water.



How It Works

1

Choose a Base

Select from a variety of bases to help secure your device where you need it.

2

Choose an Arm

Select an arm based on your desired length and placement.

3

Choose an Adapter

RAM® offers a wide selection of adapters and cradles for your specific device.



Modular Solutions for Every Use

Slip Resistant

The marine-grade aluminum or composite arm provides a strong hold that reduces slip on the rubber ball

Guaranteed

RAM® Mounts offers a lifetime warranty on all mounting hardware

Vibration Dampening

The rubber ball absorbs the impact of the rough waves, providing shock and vibration dampening

Adjustable

With nearly 360-degrees of articulation, each product may be adjusted to any angle with the turn of a single knob.

How It Works

Ball Size Selection Guide

Each ball size in the RAM® Mounts rubber ball and socket system supports a different amount of weight and withstands increasingly intense vibration. Use the guide below to determine the ideal size for your system based on your device weight and application.



B Size

- 1" Diameter Ball
- Holds up to 2 lbs
- Ideal for cup holders, cameras and fishfinders up to 5"



C Size

- 1.5" Diameter Ball
- Holds up to 4 lbs
- Ideal for tablets, fishing rods and fishfinders up to 7"



Table of Contents

- 7 Rigging Map
- 9 Bases
- 15 Arms
- 17 Spline Post Bases
- 19 RAM® Tough-Track™
- 23 Fishing Rod Holders
- 31 Spline Post Extensions
- 33 Lowrance Mounts
- 35 Humminbird Mounts
- 37 Raymarine Mounts
- 39 Garmin Mounts
- 41 Transducer Mounts
- 43 Handheld Device Mounts
- 45 Phone Mounts
- 47 Action Camera Mounts
- 53 Cup Holder Mounts
- 55 Accessories
- 61 Inflatable Watercraft Mounts
- 63 Stand Up Paddleboard Mounts
- 66 Fishfinder Compatibility Chart
- 67 Drawings Section
- 68 New Products
- 69 The Shape That Started It All

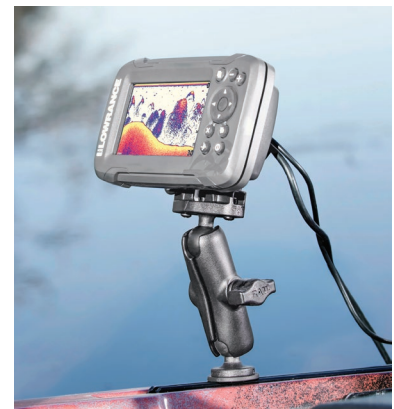
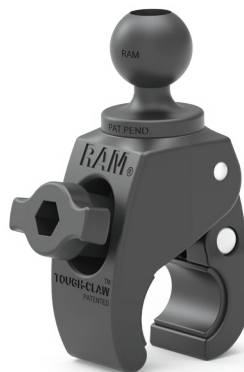

Rigging Map

Using RAM® mounting solutions, there are countless ways to customize your kayak using tracks and bases to secure your fishfinder, fishing rod, action camera and much more. This map provides inspiration with a recommended example of a common rigging scenario.



Rigging Map

1



Ball Adapter for GoPro®
pg. 48

6



RAM® Tough-Track™
pg. 21

2



RAM ROD® Holder
pg. 26

7



RAM® X-Grip® Phone Mount
pg. 46

3



RAM® Tough-Cleat™
pg. 58

8



Transducer Mount
pg. 48

4



RAM® Level Cup™ XL
pg. 54

9



Fishfinder Mount
pg. 34

5



RAM® Tough-Tube™ Rod Holder
pg. 30

10



RAM® Tough-Pole™ Camera Mount
pg. 50

Bases



Seen in this photo:
RAP-390-RB-TRA1, RAM® Tube Jr.™ with RAM® Track Ball™ base
RAP-B-354-TRA1, 1" RAM® Track Ball™ Base

Bases

RAM® Track Ball™

Designed to be compatible with all track mounting systems, these bases provide a universal mounting solution for a wide variety of RAM® kayak products including fishing rod holders, action cameras, transducer arms and more. A quick turn of the ball allows the base to slide along tracks, giving you ultimate flexibility in positioning your gear.

The RAP-B-354-TRA1 and RAP-354-TRA1 give you the lowest profile and one-handed operation, while the RAP-B-383 and RAP-383 lock to prevent unintentional rotation. For vertical installs, choose the RAP-354-AAPRU.

Part Number	Ball Size	Description
RAP-354-AAPRU	1.5" (C)	Vertical track base
RAP-354-TRA1	1.5" (C)	Low profile base
RAP-383	1.5" (C)	Locking base
RAP-B-354-TRA1	1" (B)	Low profile base
RAP-B-383	1" (B)	Locking base



Adhesive

This double-sided Pressure Sensitive Adhesive (PSA) stick pad is a great solution for mounting lightweight devices without the need to drill holes. It works on flat and curved surfaces with or without textures and includes a sealed alcohol prep pad.

Part Number	Ball Size	Diameter
RAP-B-378	1" (B)	2.5"



Suction Cup

The RAM® Twist-Lock™ Suction Cup features a diamond base and is a popular solution for mounting to any smooth, non-porous surface. Optionally, attach the suction cup to nearly any flat surface using the adhesive round disk.

Part Number	Ball Size	Suction Diameter	Accessory Disc
RAM-B-224-1	1" (B)	3.3"	RAP-350-35B



Bases



Seen in this photo:
RAM-B-400-A-GOP1U, RAM® Tough-Claw™ with Action Camera (Shown with GoPro Hero 6)

Bases

RAM® Tough-Claw™

The RAM® Tough-Claw™ provides a flexible mount for round rails or flat edges. The T-shaped knob means that you do not need any tools to install, remove or transfer your mount. Simply loosen the knob, reposition and secure.

Part Number	Ball Size	Clamp Range
RAP-400	1.5" (C)	.625" - 1.5"
RAP-B-400	1" (B)	.625" - 1.5"
RAP-404	1.5" (C)	1" - 1.875"
RAP-B-404	1" (B)	1" - 1.875"
RAP-401	1.5" (C)	1" - 2.25"
RAP-B-401	1" (B)	1" - 2.25"



RAP-400



RAP-B-400

RAM® Tough-Ball™

The RAM® Tough-Ball™ is available in both B and C Size and is designed to connect to the threaded hole of a kayak or SUP.

Part Number	Ball Size	Threaded Post
RAP-379U-252050-KAY1	1.5" (C)	1/4"-20 x .5"
RAP-B-379U-252050-KAY1	1" (B)	1/4"-20 x .5"
RAP-B-379U-M81208	1" (B)	M8-1.25 x 8MM



RAP-379U-252050-KAY1



RAP-B-379U-M81208
Compatible with Red
Paddle Board

Bases

Drill-Down Bases

The RAM® Mounts rubber ball is unique to the RAM® Mounts system. This innovative rubber ball delivers vibration dampening, nearly 360-degrees of adjustability and the ruggedness that the marine environment demands. RAM® ball bases are offered in both marine-grade aluminum and high-strength composite.

Part Number	Ball Size	Material	Plate Size	Hole Pattern
RAM-202	1.5" (C)	Marine-grade aluminum	2.5" Diameter	4-Hole AMPS
RAM-B-202	1" (B)	Marine-grade aluminum	2.5" Diameter	4-Hole AMPS
RAM-B-238	1" (B)	Marine-grade aluminum	1.3" x 2.5" Diamond	2-Hole AMPS
RAP-202	1.5" (C)	High-strength composite	2.5" Diameter	4-Hole AMPS
RAP-202-225	1.5" (C)	High-strength composite	2" x 2.5" Rectangle	1.5" x 2"
RAP-B-202	1" (B)	High-strength composite	2.5" Diameter	4-Hole AMPS
RAP-B-202U-225	1" (B)	High-strength composite	2" x 2.5" Rectangle	1.5" x 2"
RAP-B-238	1" (B)	High-strength composite	1.3" x 2.5" Diamond	2-Hole AMPS



RAP-202-225



RAP-B-238



RAM-B-202



Seen in this photo:
RAM-B-138-GOP1, Drill-Down Mount with Action Camera (Shown with GoPro Hero 6)

Bases

Wedge

If you need more versatility in device placement and don't want to drill holes, use the RAM® wedge base. The RAP-B-354-75 is designed to drop in a rod holder post and spline base, while the RAP-354-162U and RAP-385-12U are designed to drop in flush mount tube rod holders.

Part Number	Ball Size	Compatible Holes
RAP-354	1.5" (C)	Scotty and Hobie sail port base
RAP-354-162U	1.5" (C)	Flush mount tubes
RAP-354-75	1.5" (C)	RAM®, Attwood & Fish-On Bases
RAP-385-12U	1.5" (C)	Flush mount tubes
RAP-385-18U	1.5" (C)	Flush mount tubes
RAP-B-354	1" (B)	Scotty and Hobie sail port base
RAP-B-354-162U	1" (B)	Flush mount tubes
RAP-B-354-75	1" (B)	RAM®, Attwood & Fish-On Bases
RAP-B-385-12U	1" (B)	Flush mount tubes
RAP-B-385-18U	1" (B)	Flush mount tubes

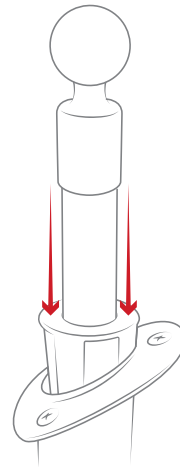

RAP-B-354-75
Post and spline adapter



RAP-354-162U
Tube rod holder adapter



RAP-385-12U
Tube rod holder adapter

Ball with Swivel Post

Convert any post and spline base into a ball base with this adapter, allowing you to use your existing rod holder base to support a wide variety of ball and socket components to hold your fishfinder or other devices.

Part Number	Ball Size	Description
RAP-354-419U	1.5" (C)	Fits any spline post base
RAP-B-354-419U	1" (B)	Fits any spline post base



RAP-B-354-419U



RAP-354-419U

Arms



Seen in this photo:
RAP-B-366U, 1" Ball with 1/4"-20 Threaded Stud
RAP-B-201, Double Socket Arm
RAP-B-202-GOP1, Universal Action Camera Ball Adapter

Arms

Arm Sizes

RAM® Mounts feature a double ball and socket system, providing modularity and adjustability. The RAM® arm connects mounting bases to your device, and is available in multiple sizes and lengths.

B Size 1"

Part Number	Material	Overall Length	Socket to Socket
RAM-B-201-A	Marine-grade aluminum	2.38"	1.75"
RAM-B-201	Marine-grade aluminum	3.69"	3"
RAM-B-201-C	Marine-grade aluminum	6"	5.25"
RAP-B-201-A	High-strength composite	2.38"	1.75"
RAP-B-201	High-strength composite	3.69"	3"
RAP-B-200-12U	High-strength composite	4.2"	3.5"



B Size
RAM-B-201

C Size 1.5"

Part Number	Material	Overall Length	Socket to Socket
RAM-201-B	Marine-grade aluminum	3.5"	2.25"
RAM-201	Marine-grade aluminum	5.625"	4.5"
RAM-201-D	Marine-grade aluminum	9.125"	8"
RAP-201U-B	High-strength composite	3.5"	2.25"
RAP-201U	High-strength composite	5.625"	4.5"



C Size
RAM-201

Spline Post Bases



Seen in this photo:
RAP-394-SSBMP, RAM® Tough-Tube™ with Bulkhead/Flat Surface Base

Spline Post Bases

Track

Ready to mount the full line of RAM® spline post rod holders, these bases are compatible with almost all track systems and are easy to install, adjust and fasten. With the RAM® Adapt-A-Post™, simply press the release button to quickly remove your spline post. Using the dual track base, just turn the knobs to loosen.

Part Number	Description
RAP-383-AAPU	RAM® Adapt-A-Post™ locking base
RAP-411-AAPU	RAM® Track-Node™ with RAM® Adapt-A-Post™
RAP-421	Dual T-bolt base
RAP-AAPU	RAM® Adapt-A-Post™ base
RAP-AAPRU	RAM® Adapt-A-Post™ vertical base

NEW



RAP-411-AAPU



RAP-AAPU



RAP-421

Wedge

This base provides a great way to mount any RAM® post and spline fishing rod holder and extension arms (in a low-profile fashion) with a quick disconnect feature. Simply slide the wedge into the round opening of your flush mount rod holder and tighten the screw to secure the wedge.

Drill-Down and Flush Mount

The Combination Bulkhead/Flat Surface Mounting Base features a locking mechanism, requiring the release of a plunger to remove the rod holder. The Round Flush Base is compatible with all RAM ROD® holders with a spline post and is an excellent solution for kayaks with limited mounting space.

Part Number	Description	Compatible Holes
RAP-AAP-162U	RAM® Adapt-A-Post™ with wedge base	Flush mount tubes

Part Number	Description
RAM-114BM	Bulkhead base
RAM-114BMP	Bulkhead/flat surface plunger base
RAM-114FM	Rectangular flush base
RAM-114FMT	Round flush base
RAP-386B-AAPU	RAM® Adapt-A-Post™ with AMPS base



RAP-AAP-162U



RAM-114BMP



RAM-114FMT

RAM® Tough-Track™



Seen in this photo:
RAP-TRACK-A5, Top-Loading Composite RAM® Tough-Track™
RAP-B-202-GOP1-354-TRA1U, RAM® Track Ball™ with Action Camera

RAM® Tough-Track™

Using a track mounting system is a clean, clever, and innovative way to secure devices. The RAM® Tough-Track™ – available in modular aluminum and top-loading composite versions—takes this innovation to the next level by offering a center access point for your track components and multiple track lengths to accommodate your desired mounting surface.

Modular Aluminum Features

- Drill to any flat surface with #8 screws
- Available in overall lengths ranging from 6" to 20"
- Includes two top-loading end caps and one flush end cap
- Compatible with the center top-loading and 90-degree connectors
- No sharp edges



The pictured inset channel on the RAM® Tough-Track™ offers smooth and convenient placement of RAM® track mounts, preventing screw heads from interfering with the T-bolt attachment.



Top-Loading Composite Features

- Drill to any flat surface with #10 screws
- Available in overall lengths ranging from 3.75" to 18.5"
- Mounting holes are outside the track for reinforced stability
- No sharp edges



RAM® Hand-Track™ Features

- Drill to any flat surface using 1/4"-20 machine screws with fender washer
- Available in overall lengths ranging from 10" to 36"
- Includes two top-loading end caps
- Compatible with RAM® Hand-Track™ extensions
- No sharp edges



RAM® Tough-Track™

Using a track mounting system is a clean, clever and innovative way to mount devices. With the RAM® Tough-Track™, customize your system with a variety of track lengths and components—for both the modular aluminum and top-loading composite versions.

Modular Aluminum RAM® Tough-Track™

Part Number	Overall Length	Inside Track Length
RAM-TRACK-EXA-3	6"	3"
RAM-TRACK-EXA-5	8"	5"
RAM-TRACK-EXA-9	12"	9"
RAM-TRACK-EXA-13	16"	13"
RAM-TRACK-EXA-17	20"	17"



RAM-TRACK-EXA-9

Modular Components

Part Number	Description
RAP-TRACK-EXA-CC90U	90-Degree Top-Loading Connector
RAP-TRACK-EXA-CCU	Center Top-Loading Connector

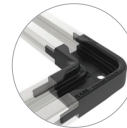

RAP-TRACK-EXA-CC90U

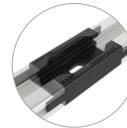

RAP-TRACK-EXA-CCU

Top-Loading Composite RAM® Tough-Track™

Part Number	Overall Length	Inside Track Length
RAP-TRACK-A2	3.75"	2.43"
RAP-TRACK-A3	4.75"	3"
RAP-TRACK-A5	7"	5"
RAP-TRACK-A9	10.75"	9"
RAP-TRACK-A12	14.5"	12"
RAP-TRACK-A16	18.5"	16"



RAP-TRACK-A9

RAM® Hand-Track™

The RAM® Hand-Track™ is an ideal track and handrail solution, and includes two top-loading end caps for attachment to a flat surface.



RAM-TRACK-H10U

RAM® Hand-Track™

Part Number	Overall Length	Inside Track Length
RAM-TRACK-H4U	10"	4"
RAM-TRACK-H6U	12"	6"
RAM-TRACK-H8U	14"	8"
RAM-TRACK-H10U	16"	10"
RAM-TRACK-H12U	18"	12"
RAM-TRACK-H15U	21"	15"
RAM-TRACK-H18U	24"	18"
RAM-TRACK-H30U	36"	30"

RAM® Hand-Track™ Extensions

Part Number	Track Length
RAM-TRACK-HC-4U	4"
RAM-TRACK-HC-6U	6"
RAM-TRACK-HC-8U	8"
RAM-TRACK-HC-10U	10"
RAM-TRACK-HC-12U	12"
RAM-TRACK-HC-15U	15"
RAM-TRACK-HC-18U	18"
RAM-TRACK-HC-30U	30"



RAM-TRACK-HC-10U

RAM® Tough-Track™

Track Mounts

RAM® offers a wide variety of track mounts to secure a range of devices, including phones, tablets, action cameras, fishfinders, fishing rods, and more. Take advantage of the RAM® Tough-Pole™ to capture photos and videos from your favorite action camera, or the popular RAM® X-Grip® holder for phones. There are even kits available for marine electronics like the Lowrance HOOK² Series, as well as a variety of RAM® rod holders.

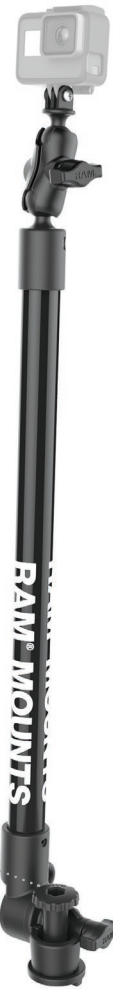
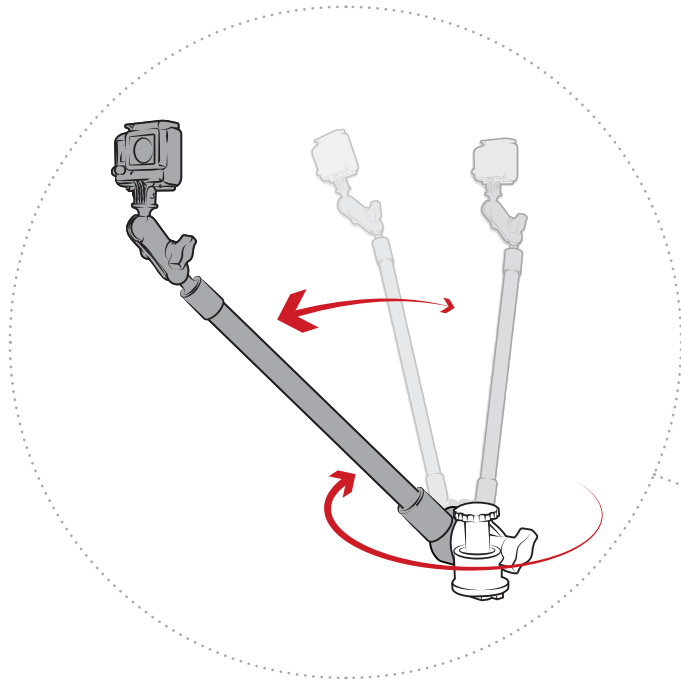

RAP-411-18-A-GOP1-1



RAP-HOL-UN7B-354-TRA1U



RAM-B-LO12-354-TRA1



RAP-114-PA-411

Fishing Rod Holders



Seen in this photo:
RAP-411-AAPU, RAM® Track-Node™ with RAM® Adapt-A-Post™
RAP-114-APB2U, 13.5" Ratchet Extension
RAP-434-NB, RAM ROD® JR with 2" Post

Fishing Rod Holders

RAM ROD® HD & RAM ROD® JR

Made for heavy-duty environments, the RAM ROD® HD features a rotating ring in the front that secures your fishing rod while trolling. The stop latch on the back can be locked into place to convert the rod holder into a tube style holder. For securing smaller fishing rods, the RAM ROD® JR has a flexible strap on the front of the holder.

RAM ROD® HD

Part Number	Description
RAP-433	6" post (no base)
RAP-433-421	6" post with dual track base
RAP-433-BMP	6" post with plunger bulkhead/flat base
RAP-433-PA-411	8" extension with RAM® Track-Node™ base

RAM ROD® JR

Part Number	Description
RAP-434-NB	2" post (no base)
RAP-434-421	2" post with dual track base
RAP-434-BMP	2" post with plunger bulkhead/flat base
RAP-434-PA-411	8" extension with RAM® Track-Node™ base
RAP-434-RBNB	Revolution post with 1.5" (C) socket arm
RAP-434-RB-TRA1	Revolution post with 1.5" (C) RAM® Track Ball™



RAP-433-421



RAP-433-BMP



RAP-434-PA-411



RAP-434-RB-TRA1

Capture video of your best catches with the RAM ROD® HD and JR. Both rod holders are compatible with the RAM® Ball Adapter for GoPro® Bases, allowing you to easily attach your action camera or even a RAM® X-Grip® to the top of the rod holder.



RAP-B-GOP2-A-GOP1U



RAP-B-GOP2-UN7U

Fishing Rod Holders



Seen in this photo:
RAP-114-PA-421, RAM-ROD® with Spline Post, Extension Arm and Track base

Fishing Rod Holders

RAM ROD® Holder

A must-have for the fishing enthusiast, the RAM ROD® can support almost any spinning reel or baitcaster with an optional locking latch. The RAM ROD® offers a secure hold for rough waters while also offering quick removal of your rod. Compatible with any RAM® post and spline or ball and socket mounting systems.

Kits

Part Number	Description
RAM-114-B	Post with bulkhead base
RAM-114-BMP	Post with bulkhead/flat surface plunger base
RAM-114-F	Post with flush base
RAM-114-RB	Revolution arm and drill-down ball base
RAM-114-RB-TRA1	Revolution arm and RAM® Track Ball™ base
RAM-117	Double ball and socket with drill-down base
RAP-114-PA-411	Rod Holder with Extension Arm and RAM® Track-Node™ Base
RAP-114-PA-421	Ratchet arm with dual track base
RAP-340	Single ball and socket with drill-down base
RAP-340-TRA1	Single ball and socket with RAM® Track Ball™ 1.5" (C) ball base



RAM-114-BMP



RAM-114-RB-TRA1

Holders

Part Number	Description
RAM-114-NB	6" Post
RAM-114-RBNBU	Revolution arm with 1.5" (C) socket
RAM-117B	1.5" (C) Ball
RAP-340NB	1.5" (C) Socket arm



RAM-114-NB



RAM-114-RBNBU

Fishing Rod Holders



Seen in this photo:
RAP-390-PA-411, RAM® Tube Jr.™ with Extension Arm and RAM® Track-Node™ Base

Fishing Rod Holders

RAM® Tube Jr.™

Lightweight and incredibly versatile, the RAM® Tube Jr.™ features an open-ended tube for securing spinning reels on one end, and baitcasters on the opposite end. Various grooves and locking slots are integrated into this tube to secure any fishing rod in the most comfortable position for the user.

Kits

Part Number	Description
RAP-390-AAP	6" Post with RAM® Adapt-A-Post™ track base
RAP-390-BMP	6" Post with bulkhead/flat surface plunger base
RAP-390-BU	6" Post with bulkhead base
RAP-390-F	6" Post with flush base
RAP-390-FMT	6" Post with round flush base
RAP-390-PA-411	RAM® Tube Jr.™ Rod Holder with extension arm and RAM® Track-Node™ base
RAP-390-PA-418	Ratchet arm with track base
RAP-390-PA-421	Ratchet arm with dual track base
RAP-390-RB	Revolution arm and drill-down with 1.5" (C) ball base
RAP-390-RB-TRA1	Revolution arm and 1.5" (C) RAM® Track Ball™ base
RAP-390-SAAPU	4" Post with RAM® Adapt-A-Post™ track base
RAP-390-SBMP	4" Post with bulkhead/flat surface plunger base
RAP-390-SBU	4" Post with bulkhead base
RAP-390-SF	4" Post with flush base
RAP-390-SFMTU	4" Post with round flush base



RAP-390-RB



RAP-390-SFMTU

Holder

Part Number	Description
RAP-390	6" Post
RAP-390-STU	4" Post
RAP-390-RB-NB	Revolution arm with 1.5" (C) socket



RAP-390-STU



RAP-390-RB-NB

Fishing Rod Holders



Seen in this photo:
RAP-385-12-394, RAM® Tough-Tube™ Rod Holder with RAM® Press-N-Lock™ Base

Fishing Rod Holders

RAM® Tube™ and RAM® Tough-Tube™

The RAM® Tube™ series features a large universal tube holder for securing most fishing rods for any environment. Available with the post and spline or ball and socket interface.

Kits

Part Number	Description
RAM-119	1.5" (C) Socket arm with drill-down base
RAM-301-B	Post with bulkhead base
RAM-301-BMP	Post with bulkhead/flat surface plunger base
RAM-301-F	Post with flush base
RAM-301-RB	Revolution arm with 1.5" (C) drill-down ball base
RAP-119	1.5" (C) Socket arm with drill-down base
RAP-119-TRA1	1.5" (C) Socket arm with RAM® Track Ball™ base
RAP-385-12-394	RAM® Tough-Tube™ Rod Holder with RAM® Press-N-Lock™
RAP-394-418	RAM® Tough-Tube™ with track base
RAP-394-SSBMP	RAM® Tough-Tube™ with bulkhead/flat surface plunger base
RAP-394-SSF	RAM® Tough-Tube™ with flush base
RAP-394-SSFMT	RAM® Tough-Tube™ with round flush base

Holders

Part Number	Description
RAM-119B	1.5" (C) Socket arm
RAM-301-NB	6" Post
RAM-301-RBNBU	Revolution arm with 1.5" (C) socket
RAP-394-SST	RAM® Tough-Tube™ with post
RAP-119NBU	1.5" (C) Socket arm



RAM-301-BMP



RAP-394-SSBMP



RAP-394-SST



RAM-301-RBNBU

RAM® Light-Speed™ and Fly Rod Jr.

The RAM® Light-Speed™ series is ideally suited for spinning reels and baitcasting reels, while the Fly Rod Jr. is designed specifically for fly rods and reels.

Kits

Part Number	Description
RAP-341	Fly Rod Jr. with drill-down ball base
RAP-341-TRA1	Fly Rod Jr. with RAM® Track Ball™ base
RAP-370-B	RAM® Light-Speed™ post with bulkhead base
RAP-370-F	RAM® Light-Speed™ post with flush base
RAP-370-R	RAM® Light-Speed™ post with rail base
RAP-370-RB	RAM® Light-Speed™ Revolution arm with 1.5" (C) drill-down ball base



RAP-370-RB



RAP-341-TRA1

Holders

Part Number	Description
RAP-370-NBU	RAM® Light-Speed™ with 4" post
RAP-370-RB-NBU	RAM® Light-Speed™ Revolution arm with 1.5" (C) socket
RAP-341NB	Fly Rod Jr. with 1.5" (C) socket

Spline Post Extensions



Seen in this photo:
RAP-411-AAPU, RAM® Track-Node™ with RAM® Adapt-A-Post™
RAP-114-APB2, 13.5" Ratchet Extension
RAP-434-NB, RAM ROD® JR with 2" Post

Spline Post Extensions

Compatible with all RAM® fishing rod holders and accessories using the spline post interface, these extensions allow rod holders to sit higher off the deck of the kayak—ideal for keeping rods from interfering on pedal kayaks. In addition, these extensions provide increased functionality and versatility for nearly any fishing setup.

Part Number	Description
RAP-114-APB2	13.5" Ratchet extension
RAP-114-APB3U	16" Ratchet extension
RAP-114-AP-RBU	11.5" Ratchet with 1.5" (C) socket
RAP-114-EX6	9" PVC pipe extension
RAP-114-EX8	11" PVC pipe extension
RAP-114-EX12	15" PVC pipe extension
RAP-114-PAU	8" Ratchet arm



RAP-114-EX8



RAP-114-AP-RBU



RAP-114-APB2U

Lowrance Mounts



Seen in this photo:
RAM-B-LO12-354-TRA1, RAM® Track Ball™ Mount (shown with Lowrance Hook² 4)

Lowrance Mounts

RAM® offers the most reliable mounting systems for your Lowrance head unit no matter where you need it. Choose from drill-down, track base, and clamping mounts that all use the RAM® ball and socket system to ensure the ideal placement and security of your Elite, HOOK, or Hook² fishfinder.

Kits		
Part Number	Compatible Device	Mount Type
RAM-101-LO11	Elite-7 Ti², Elite-7, HOOK-7	Drill-down
RAM-101-LO12	Hook² 5 & 5x	Drill-down
RAM-111	HDS LIVE 7, HDS-7, Hook² 7 & 7x	Drill-down
RAM-111-B	HDS LIVE 7, HDS-7, Hook² 7 & 7x	Drill-down
RAM-111B-354-TRA1	HDS-7, Hook² 7 & 7x	Track
RAM-107	Elite-7 Ti², Elite-7, HOOK-7	Drill-down
RAM-B-101-LO11	HOOK-3x, Elite-4, HOOK-4, Elite-5, HOOK-5	Drill-down
RAM-B-101-C-LO11	HOOK-3x, Elite-4, HOOK-4, Elite-5, HOOK-5	Drill-down
RAM-B-101-LO12	Hook² 4 & 4x	Drill-down
RAM-B-107	Elite-4, HOOK-4, Elite-5, HOOK-5	Drill-down
RAM-B-LO12-354-TRA1	Hook² 4 & 4x	Track
RAP-101-LO12	Hook² 5 & 5x	Drill-down
RAP-B-101-LO12	Hook² 4 & 4x	Drill-down
RAP-B-107B-354-TRA1	Elite-4, HOOK-4, Elite-5, HOOK-5	Track
RAP-B-202-LO11-354-TRA1	HOOK-3x, Elite-4, HOOK-4, Elite-5, HOOK-5	Track

*see page 66 for all device compatibility

Holders		
Part Number	Ball Size	Compatible Device
RAM-107B	1.5" (C)	Elite-7 Ti², Elite-7, HOOK-7
RAM-111B	1.5" (C)	HDS-7, Hook² 7 & 7x
RAM-202-LO11	1.5" (C)	Elite-7, HOOK-7
RAM-202-LO12	1.5" (C)	Hook² 5 & 5x
RAM-B-107B	1" (B)	Elite-4, HOOK-4, Elite-5, HOOK-5
RAM-B-202-LO11	1" (B)	HOOK-3x, Elite-4, HOOK-4, Elite-5, HOOK-5
RAM-B-202-LO12	1" (B)	Hook² 4 & 4x

*see page 67 for drawings



Humminbird Mounts



Seen in this photo:
RAM-TRACK-EXA-9, 9" Modular Aluminum RAM® Tough-Track™
RAP-B-202-153-354-TRA1, RAM® Track Ball™ Mount (shown with Humminbird Helix 5)

Humminbird Mounts

No matter which Humminbird unit you have, RAM® offers a wide range of double ball and socket mounts – in a variety of sizes and lengths – so you can position your device at the best angle and in the perfect location.

Kits

Part Number	Compatible Device	Mount Type
RAM-202-153-202	Helix 5	Drill-down
RAM-202-24-202	Helix 7	Drill-down
RAM-202-24-354-TRA1	Helix 7	Track
RAM-B-107	500 & 600 Series	Drill-down
RAM-B-107-1	PiranhaMAX Series	Drill-down
RAP-B-107-1B-354-TRA1	PiranhaMAX Series	Track
RAP-B-107B-354-TRA1	500 & 600 Series	Track
RAP-B-202-153-354-TRA1	Helix 5	Track

*see page 66 for all device compatibility

Holders

Part Number	Ball Size	Compatible Device
RAM-202U-153	1.5" (C)	Helix 5
RAM-202U-24	1.5" (C)	Helix 7
RAM-B-107B	1" (B)	500 & 600 Series
RAM-B-107-1B	1" (B)	PiranhaMAX Series

*see page 67 for drawings



Raymarine Mounts



Seen in this photo:
RAP-B-379U-M616, RAM® Tough-Ball™ (shown with Raymarine Dragonfly 4 Adapter)
RAM-B-201, Medium Double Socket Arm
RAP-B-354-TRA1, 1" (B) RAM® Track Ball™ Base

Raymarine Mounts

To accommodate the smaller Dragonfly and WiFish devices, RAM® has developed the RAM® Tough-Ball™ that threads directly into the head unit for a clean and secure install. Mount your Raymarine device virtually anywhere with standard drill-down kits or customize with any combination of ball and socket components.

Kits

Part Number	Compatible Device	Description
RAM-101-RYM1	Dragonfly 6 & 7	Drill-down mount
RAM-B-202-379-M616	Dragonfly 4, 5 & WiFish	Drill-down mount
RAM-B-224-1-379-M616	Dragonfly 4, 5 & WiFish	Suction cup mount
RAM-B-400-379-M616	Dragonfly 4, 5 & WiFish	RAM® Tough-Claw™ mount

*see page 66 for all device compatibility

HOLDERS

Part Number	Ball Size	Compatible Device
RAM-202U-RYM1	1.5" (C)	Dragonfly 6 & 7
RAP-B-379U-M616	1" (B)	Dragonfly 4, 5 & WiFish

*see page 67 for drawings



Garmin Mounts



Seen in this photo:
RAM-111B-354-TRA1, RAM® Track Ball™ Mount (shown with Garmin Striker 5dv)

Garmin Mounts

Your Garmin electronics deserve only the best when it comes to rugged and reliable mounting. RAM® Mounts will keep your GPSMAP, echoMAP or Striker unit exactly where you want it, with vibration dampening to keep your fishfinder secure while on choppy waters.

Kits

Part Number	Compatible Device	Mount Type
RAM-111	Striker 7, echoMAP 62-95	Drill-down
RAM-111-B	Striker 7, echoMAP 62-95	Drill-down
RAM-111B-354-TRA1	Striker 7, echoMAP 62-95	Track
RAM-B-101-G4	Striker 4, echoMAP 42-55, GPSMAP 527 & 547	Drill-down
RAM-B-111	Striker 5	Drill-down
RAM-B-111U-A	Striker 5	Drill-down
RAM-B-111U-C	Striker 5	Drill-down
RAP-B-111B-354-TRA1	Striker 5	Track

*see page 66 for all device compatibility

Holders

Part Number	Ball Size	Compatible Device
RAM-111B	1.5" (C)	Striker 7, echoMAP 62-95
RAM-B-111B	1" (B)	Striker 5
RAM-B-202-G4U	1" (B)	Striker 4, echoMAP 42-55, GPSMAP 527 & 547

*see page 67 for drawings

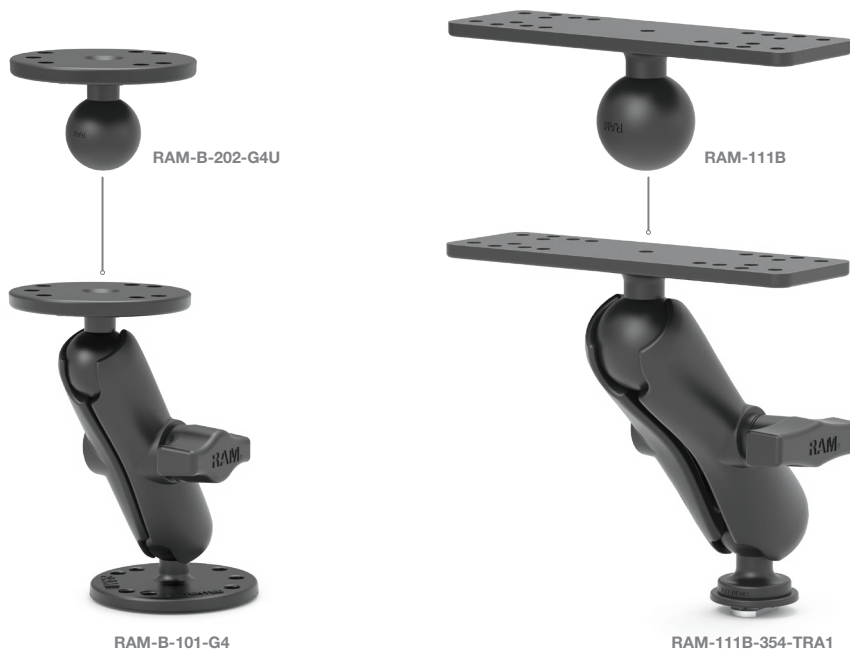

Transducer Mounts



Seen in this photo:
RAP-B-202-153-354-TRA1, RAM® Track Ball™ Mount (shown with Humminbird Helix 5)
RAP-B-316-18-TRA1-TRA1, RAM® Track Ball™ with 18" Transducer Mount

Transducer Mounts

Kayak fishing is all about adaptability, which is why RAM® offers a deployable transducer arm for kayaks. This solution enables the quick and effective deployment and retrieval of your transducer, while protecting it from damage. This unique design provides a universal solution for virtually any kayak as well as any transducer.

Kits with Base

Part Number	Compatible Transducer	Mount Type
RAM-B-316-18-TRA1	Universal (1/4"-20 screw attachment)	Drill-down
RAM-B-316-18-TRA1-TRA1	Universal (1/4"-20 screw attachment)	Track
RAM-B-316-18-TRA2	HydroWave Speaker	Drill-down
RAM-B-316-18-TRA3	Lowrance StructureScan LSS-1 & LSS-2	Drill-down

Kits with no Base

Part Number	Ball Size	Compatible Transducer
RAM-316-18-TRA4-NB	1.5" (C)	Lowrance TotalScan
RAM-B-316-18-TRA1-NB	1" (B)	Universal (1/4"-20 screw attachment)
RAM-B-316-18-TRA2-NB	1" (B)	HydroWave Speaker
RAM-B-316-18-TRA3-NB	1" (B)	Lowrance StructureScan LSS-1 & LSS-2

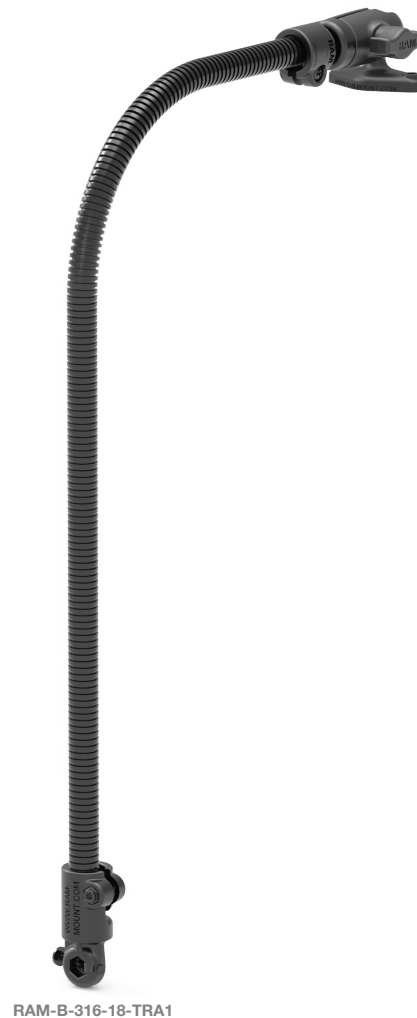

Handheld Device Mounts



Seen in this photo:
RAP-B-400-238U, RAM® Tough-Claw™ Double Ball Mount
RAM-HOL-UN4U, RAM® Finger-Grip™ Universal Holder (Shown with BaoFeng UV-82HP)

Handheld Device Mounts

Count on RAM® to protect and position your handheld device at the ideal viewing angle. Whether you're mounting a handheld GPS, radio or bluetooth speaker, these cradles provide easy insertion and removal of your device along with multiple options for installation.

Kits

Part Number	Compatible Devices	Mount Type
RAM-B-138-GA40	Garmin GPSMAP 73, 78, 78S, 78SC	Drill-down
RAM-B-138-GA41	Garmin Astro 320, GPSMAP 62, 64	Drill-down
RAM-B-138-GA46	Garmin Montana series	Drill-down
RAM-B-138-UN4	Universal - Handheld Fishfinder, GPS, Radio, Bluetooth Speaker	Drill-down

Holders

Part Number	Compatible Devices	Compatible Ball
RAM-B-202-GA76	Garmin Handheld Units with Spine Adapter	RAM-B-238 (included)
RAM-HOL-GA40	Garmin GPSMAP 73, 78, 78S, 78SC	RAM-B-238
RAM-HOL-GA41	Garmin Astro 320, GPSMAP 62, 64	RAM-B-238
RAM-HOL-GA46U	Garmin Montana series	RAM-B-238
RAM-HOL-UN4	Universal - Handheld Fishfinder, GPS, Radio, Bluetooth Speaker	RAM-B-238
RAM-HOL-SPO5U	RAM® EZ-Roll'r™ cradle for the SPOT X™	RAM-B-238

RAM® Finger-Grip™ Compatible Dimensions

Width Range	Height Range	Thickness Range
1.25" - 3.5"	up to 7.25"	up to 1.5"



RAM-B-202-GA76



RAM-HOL-SPO5U

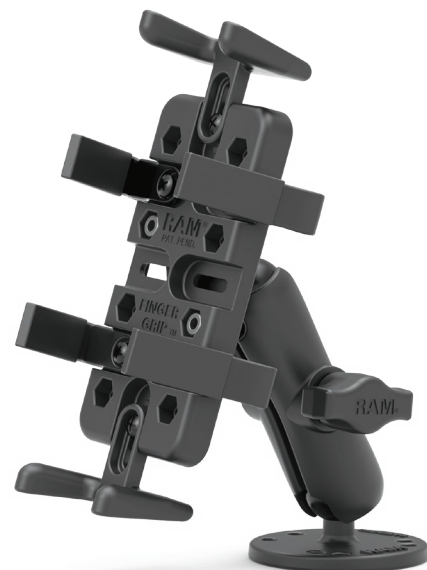

RAM-B-138-UN4
RAM® Finger-Grip™

Phone Mounts



Seen in this photo:
RAP-B-378-UN7, RAM® X-Grip® with Flex Adhesive Mount (shown with iPhone X in a case)

Phone Mounts

The RAM® X-Grip® will keep your phone secure while out on the water no matter which mounting base you use. Whether using your phone as a camera or operating a fishfinder app, your device will stay safe and accessible with the RAM® X-Grip® and tether for outdoor applications.

Kits

Part Number	Phone Size	Mount Type
RAM-B-102-UN7	Small phones	Drill-down mount - diamond base
RAM-B-102-UN10U	Large phones	Drill-down mount - diamond base
RAM-B-138-UN7	Small phones	Drill-down mount - round base
RAM-B-138-UN10	Large phones	Drill-down mount - round base
RAM-B-166-UN7	Small phones	RAM® Twist-Lock™ suction cup - standard arm
RAM-B-166-UN10	Large phones	RAM® Twist-Lock™ suction cup - standard arm
RAM-B-166-A-UN7U	Small phones	RAM® Twist-Lock™ suction cup - short arm
RAM-B-166-C-UN10U	Large phones	RAM® Twist-Lock™ suction cup - long arm
RAM-B-400-A-HOL-UN7BU	Small phones	RAM® Tough-Claw™ mount - short arm
RAM-B-400-A-HOL-UN10BU	Large phones	RAM® Tough-Claw™ mount - short arm
RAM-B-400-C-UN7U	Small phones	RAM® Tough-Claw™ mount - long arm
RAM-B-400-C-UN10U	Large phones	RAM® Tough-Claw™ mount - long arm
RAM-HOL-UN7-400	Small phones	RAM® Tough-Claw™ mount - low profile
RAM-HOL-UN10-400	Large phones	RAM® Tough-Claw™ mount - low profile
RAP-B-378-UN7	Small phones	Flex adhesive mount
RAP-B-378-UN10U	Large phones	Flex adhesive mount
RAP-HOL-UN7B-354-TRA1	Small phones	RAM® Track Ball™ mount

Holders

Part Number	Ball Size	Phone Size
RAM-HOL-UN7B	1" (B)	Small Phones (up to 3.25" wide)
RAM-HOL-UN7BCU	1.5" (C)	Small Phones (up to 3.25" wide)
RAM-HOL-UN10B	1" (B)	Large Phones (up to 4.5" wide)
RAM-HOL-UN10BCU	1.5" (C)	Large Phones (up to 4.5" wide)



RAM-B-166-UN7



RAM-HOL-UN10-400

Action Camera Mounts



Seen in this photo:
RAP-B-400-GOP1U, RAM® Tough-Claw™ Mount with Action Camera (Shown with GoPro Hero 6)

Action Camera Mounts

Double Ball Mounts

Count on RAM® to connect to any action camera, whether using the standard 1/4"-20 thread or the modern action camera hinge adapter. The unique double ball and socket design lets you position your camera at the perfect angle with a single knob for 360-degree rotation, and is compatible with several different mount types.

Kits

Part Number	Ball Type	Mount Type
RAM-B-138-A-GOP1	Action camera adapter	Drill-down mount
RAM-B-166-GOP1	Action camera adapter	RAM® Twist-Lock™ suction cup mount
RAM-B-202-A-366U	1/4"-20 threaded stud	Drill-down mount
RAM-B-224-1-366	1/4"-20 threaded stud	RAM® Twist-Lock™ suction cup mount
RAM-B-400-A-366U	1/4"-20 threaded stud	RAM® Tough-Claw™ rail mount
RAM-B-400-A-GOP1U	Action camera adapter	RAM® Tough-Claw™ rail mount
RAP-B-202-GOP1-354-TRA1	Action camera adapter	RAM® Track Ball™ mount
RAP-B-366-153-354-TRA1	1/4"-20 threaded stud	RAM® Track Ball™ mount
RAP-B-400-GOP1U	Action camera adapter	RAM® Tough-Claw™ rail mount
RAP-B-GOP2-A-GOP1U	Action camera adapter	GoPro® base adapter mount

Holders

Part Number	Ball Size	Description
RAP-B-202-GOP1	1" (B)	2-Prong Action Camera Adapter
RAP-B-379-252025	1" (B)	RAM® Tough-Ball™ 1/4"-20 threaded stud



RAP-B-202-GOP1-354-TRA1



RAP-B-GOP2-A-GOP1U



RAM-B-400-A-366U



RAP-B-202-GOP1

Action Camera Mounts



Seen in this photo:
RAP-B-202-GOP1-A-294-18U, RAM® Tough-Pole™ Action Camera Mount
RAP-421, Dual T-Bolt Track Base

Action Camera Mounts

RAM® Tough-Pole™ Action Camera Mounts

Get the perfect shot from your action camera when you're out on the water using the RAM® Tough-Pole™. Available for track mounts and spline posts, the RAM® Tough-Pole™ provides up to a 36" extension for your action camera.

Mounts

Part Number	Base Type	Pipe Configuration
RAP-114BD-4-12-A-GOP1	Bulkhead/flat surface plunger base	4" and 12" pipes - ball and socket connection
RAP-114BD-4-12-4-A-GOP1	Bulkhead/flat surface plunger base	4", 12" and 4" pipes - ball and socket connection
RAP-354-TRA1-12-A-GOP1	RAM® Track Ball™ base	Single 12" pipe
RAP-354-TRA1-12-4-A-GOP1	RAM® Track Ball™ base	12" and 4" pipes - ball and socket connection
RAP-385-12-18-A-GOP1	RAM® Press-N-Lock™ wedge base	Single 18" pipe
RAP-385-12-18-18-A-GOP1	RAM® Press-N-Lock™ wedge base	Double 18" pipe - ratchet connection
RAP-411-18-A-GOP1	RAM® Track-Node™ with post/spline	Single 18" pipe
RAP-411-18-A-GOP1-1	RAM® Track-Node™ base	Single 18" pipe
RAP-411-18-18-A-GOP1	RAM® Track-Node™ with post/spline	Double 18" pipe - ratchet connection
RAP-411-18-18-A-GOP1-1	RAM® Track-Node™ base	Double 18" pipe - ratchet connection
RAP-425-18-A-GOP1	Track Base (direct to pipe)	Single 18" pipe
RAP-425-4-A-GOP1	Track Base (direct to pipe)	Single 4" pipe
RAP-425-18-18-A-GOP1	Track Base (direct to pipe)	Double 18" pipe - ball and socket connection
RAP-425-4-18-A-GOP1	Track Base (direct to pipe)	4" and 18" pipe - ball and socket connection



RAP-385-12-18-A-GOP1



RAP-114BD-4-12-A-GOP1



RAP-411-18-A-GOP1-1



RAP-411-18-18-A-GOP1

Action Camera Mounts

RAM® Tough-Pole™ Extension Arms

Select from a wide variety of pole lengths with multiple articulation points to capture the best footage while out on the water. The following RAM® Tough-Pole™ extension arms can connect to any post and spline base or any 1.5" ball.

Part Number	Base Type	Pipe Configuration
RAP-114-PSP-4-A-GOP1	Post/Spline	Single 4" pipe
RAP-114-PSP-4-12-A-GOP1	Post/Spline	4" and 12" pipes - ball and socket connection
RAP-114-PSP-4-12-4-A-GOP1	Post/Spline	4", 12" and 4" pipes - ball and socket connection
RAP-201-B-12-A-GOP1	1.5" (C) Ball	Single 12" pipe
RAP-201-B-12-4-A-GOP1	1.5" (C) Ball	12" and 4" pipes - ball and socket connection
RAP-B-202-GOP1-A-294-18U	Post/Spline	Single 18" pipe
RAP-B-202-GOP1-A-420-424-18U	Post/Spline	Double 18" pipe - ratchet connection



RAP-201-B-12-A-GOP1



RAP-B-202-GOP1-A-294-18U



RAP-201-B-12-4-A-GOP1



RAP-114-PSP-4-12-4-A-GOP1

Action Camera Mounts

Build Your Own RAM® Tough-Pole™

Building and customizing a RAM® Tough-Pole™ to fit your specific needs is easy and can be done in three steps: choosing a top connection for your device, choosing the length you need and choosing the bottom connection. See below to see the features and how it can all come together.

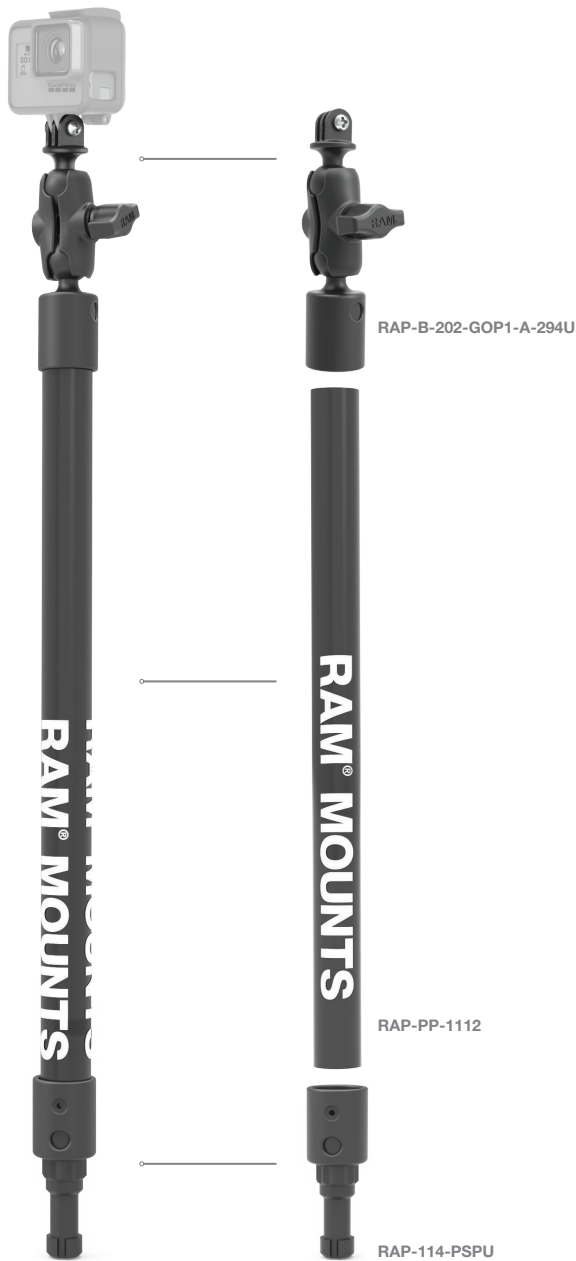

1 Choose a top component

Part Number	Description
RAP-AAP-PPU	RAM® Adapt-A-Post™ for any spline posts
RAP-B-202-GOP1-A-294U	Action Camera Double ball mount for action cameras
RAP-294U	1.5" (C) Ball
RAP-B-294U	1" (B) Ball

2 Choose the length you need

Part Number	Pipe Length
RAP-PP-1102	2"
RAP-PP-1104	4"
RAP-PP-1106	6"
RAP-PP-1108	8"
RAP-PP-1112	12"
RAP-PP-1118	18"

3 Choose a bottom component

Part Number	Description
RAP-114-PSPU	Spline Post - connects to any spline post base
RAP-201-B-294U	Double Socket Arm - connects to any 1.5" (C) ball (shown in pg. 51)

Cup Holder Mounts



Seen in this photo:
RAP-B-366U, 1" Ball with 1/4"-20 Threaded Stud
RAM-B-201, Double Socket Arm
RAP-B-417B, RAM® Level Cup™ XL

Cup Holder Mounts

Drink Cup Holder for Tracks

The RAM® Drink Cup Holder for tracks is the perfect cradle for your beverage when out on the water. Fitting a variety of cup sizes, a slot on the side even accommodates your favorite cup or mug with a handle. Hook slots are perfectly placed for lures and the cup holder features two attachment points—one on the side for attaching to vertically-mounted tracks, and one on the bottom for attaching to horizontally-mounted tracks.

Kits		
Part Number	Drink Size	Base Type
RAP-429T	32oz	Track base



RAP-429T

RAM® Level Cup™ XL

The self-leveling RAM® Level Cup™ XL keeps your beverages from spilling and integrates an adjustable height option for accommodating large drink sizes, such as tumblers and water bottles. Whether you have a Nalgene or Hydro Flask, the RAM® Level Cup™ XL will secure most 32oz containers.

Kits		
Part Number	Drink Size	Base Type
RAM-B-132-400	16oz	Clamp/rail
RAP-B-417-400	32oz	Clamp/rail
RAM-B-417B-C-354-TRA1	32oz	Track base

Holders		
Part Number	Drink Size	Attachment Type
RAM-B-132B	16oz	1" (B) Ball
RAP-B-132B-201U	16oz	Double socket arm connects to any 1" (B) ball
RAP-B-417B	32oz	1" (B) Ball
RAP-B-417-200-1U	32oz	Single socket arm connects to any 1" (B) ball
RAM-B-417B-C-201U	32oz	Double socket arm connects to any 1" (B) ball
RAP-417B	32oz	1.5" (C) Ball



RAM-B-417B-C-354-TRA1U



RAP-B-417-400



RAP-B-417B

Accessories



Seen in this photo:
RAP-412-2, RAM® Roller-Ball™ 2-Pack

Accessories

RAM® Roller-Ball™

Ensure quiet placement and removal of fishing accessories like nets, paddles, gaff hooks, stakeout/push poles, BogaGrips®, and more with the RAM® Roller-Ball™. The T-bolt attachment on the underside of this accessory makes it compatible with the RAM® Tough-Track™ and most third-party track mounting systems. Holds paddles and poles 1" - 1 5/16" in diameter.

Part Number	Description
RAP-412	Single Pack
RAP-412-2	2-Pack



Seen in this photo:
RAM-TRACK-EXA-5, 5" Modular Aluminum RAM® Tough-Track™
RAP-TRACK-EXA-CCU, Center Connector for Modular Aluminum RAM® Tough-Track™
RAP-412, RAM® Roller-Ball™

Accessories



Seen in this photo:

RAP-398-BLK-TRACK-AU, RAM® Bond-A-Base™ with RAM® Tough-Track™

RAP-B-202-GOP1-354-TRA1U: RAM® Track Ball™ with Action Camera Adapter

RAP-432, RAM® Tough-Cleat™

Accessories

RAM® Tough-Cleat™

Create an anchor tie-off point for your kayak while on the river or lake. Simply loosen the knob and slide the T-bolt attachment along your track mounting system.

Accessories

Part Number	Description
RAP-432	RAM® Tough-Cleat™



RAP-432

Anchor Line Lock

For use with anchor lines up to 1/2" in diameter, this Anchor Line Lock with spline post can be flush mounted or mounted using an existing rod holder base.

Accessories

Part Number	Description
RAP-357U	Anchor line lock
RAP-357P	Anchor line lock with spline post
RAP-357P-B	Anchor line lock with bulkhead plunger base



RAP-357P

Accessories

RAM® Tough-Clip™

The RAM® Tough-Clip™ Paddle Cradle allows you to easily attach your paddle to a canoe, kayak or paddleboard. The universal design holds most paddles with a handle of 1"-1.31" in diameter.

Accessories

Part Number	Description
RAP-430-224	RAM® Tough-Clip™ with double suction cup mount
RAP-430-400	RAM® Tough-Clip™ with small RAM® Tough-Claw™
RAP-430TD	RAM® Tough-Clip™ with T-nut and drill-down hardware

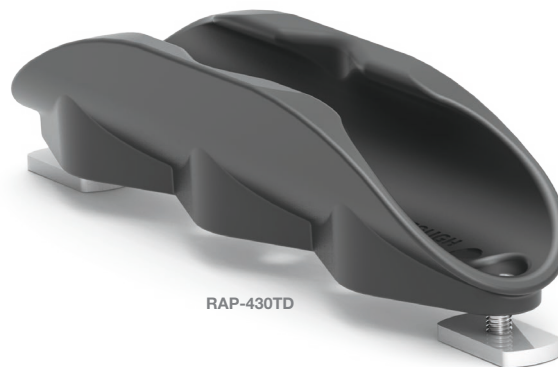

Vertical Tie-Down

As a pack of two, the Vertical Track Tie Down provides an anchor point for use with your track mounting system to secure coolers and other accessories to your kayak. Designed to work with 1" and 1.5" flat webbing, as well as ropes and bungee cords up to 3/8".

Accessories

Part Number	Description
RAP-431	Vertical Tie-Down for tracks (Sold in pairs)



Accessories

RAM® Pin-Lock™ Security Knob

Utilize the RAM® Pin-Lock™ to help deter theft and add extra security for your RAM® mounting system and devices. This special keyed knob is available in different styles to lock double socket arms, swing arms, and gimbals.

Part Number	Description
RAP-S-KNOB3	Security knob for B size socket arms
RAP-S-KNOB5	Security knob for B size socket arms
RAP-S-KNOBG	Security knob for gimbal brackets



RAP-S-KNOB5

RAM® Mari-Rivet™ & RAM® Mari-Nut™

Sometimes you have the need for a blind hole mount, and RAM® offers the RAM® Mari-Rivet™ for a permanent mount. Suited for material 1/16" to 1/4" thick, this is a great mounting option for fiberglass, plastic and metal mounting locations. The RAM® Mari-Nut™ allows for a non-permanent and light duty way to mount to blind holes.

Accessories

Part Number	Compatible Components	Grip Thickness	Hole Size Required
RAM-MARI-RIVET-4	Ball bases with 4 holes	1/16" - 1/4"	7/32"
RAM-MARI-NUT-4	Ball bases with 4 holes	3/100" - 23/100"	3/8"



RAM-MARI-RIVET-4



RAM-MARI-NUT-4

Inflatable Watercraft Mounts



Seen in this photo:
RAP-340NB, RAM ROD® 2007 Fishing Rod Holder
RAP-399U, Float Tube Adapter with Strap and 1.5" Ball

Inflatable Watercraft Mounts

RAM® Bond-A-Base™

For inflatable rafts, the RAM® Bond-A-Base™ is the ideal universal mounting solution. Using the included 3M™ VHB™ double back adhesive pad, the flexible RAM® Bond-A-Base™ can be applied to PVC and Hypalon watercraft.

Part Number	Description
RAP-398-BLKU	Black base
RAP-398-BLK-202U	Black base with 1.5" (C) ball
RAP-398-BLK-114BMPU	Black base with post/spline receiver
RAP-398-BLK-TRACK-A	Black base with RAM® Tough-Track™
RAP-398-GRYU	Grey base
RAP-398-GRY-202U	Grey base with 1.5" (C) ball
RAP-398-GRY-114BMPU	Grey base with post/spline receiver
RAP-398-GRY-TRACK-A	Grey base with RAM® Tough-Track™



Strap Base

For inflatable personal fishing pontoons, this base is secured using straps and allows you to easily mount a fishing rod holder and more.

Part Number	Ball Size
RAP-399U	1.5" (C)
RAP-B-399U	1" (B)



Stand Up Paddleboard Mounts



Seen in this photo:
RAM-B-166-UN7, RAM® X-Grip® Phone Mount with RAM® Twist-Lock™ Suction Cup (shown with iPhone X in a case)

Stand Up Paddleboard Mounts

Whether you need to mount your action camera, drink, paddle or phone to your stand up paddleboard, RAM® has you covered. Solutions like the Flex Adhesive Base, RAM® Tough-Pole™ and double and triple RAM® Twist-Lock™ Suction Cup will keep your devices secure on your SUP.

Kits

Part Number	Device	Mount Type
RAM-B-166-GOP1	Action cameras	RAM® Twist-Lock™ suction cup double ball
RAM-B-166-UN7	Small phones	RAM® Twist-Lock™ suction cup double ball
RAM-B-166-UN8	Small tablets	RAM® Twist-Lock™ suction cup double ball
RAM-B-166-UN10	Large phones	RAM® Twist-Lock™ suction cup double ball
RAP-224-18-A-GOP1	Action cameras	18" RAM® Tough-Pole™ with suction cup
RAP-224-18-A-UN7	Small phones	18" RAM® Tough-Pole™ with suction cup
RAP-224-18-A-UN10	Large phones	18" RAM® Tough-Pole™ with suction cup
RAP-365-18-429	Drink cup holder	18" RAM® Tough-Pole™ with triple suction cup
RAP-365-18-430	Paddle holder	18" RAM® Tough-Pole™ with triple suction cup
RAP-430-224	Paddle holder	Low profile double suction cup
RAP-B-378-202U-GOP1	Action cameras	Flex adhesive double ball mount
RAP-B-378-UN7	Small phones	Flex adhesive double ball mount
RAP-B-378-UN8	Small tablets	Flex adhesive double ball mount
RAP-B-378-UN10U	Large phones	Flex adhesive double ball mount



RAP-430-224



RAP-B-378-UN7



RAM-B-166-GOP1

Stand Up Paddleboard Mounts

Leash Cup and Plug Adapters

With a simple twist of the base, quickly secure the RAM® Leash Plug Adapter to your board. Add an arm or fishing rod holder to complete your custom SUP mount.

Ball Bases

Part Number	Ball Size
RAP-B-405U	1" (B)
RAP-405U	1.5" (C)



RAP-B-405U

Leash Cup

Part Number

RAP-406U



RAP-406U

RAM® Tough-Ball™

When a male threaded post is needed for your SUP, the RAM® Tough-Ball comes through. Attach a wide variety of arms and fishing rod holders to the 1" rubber ball.

Tough-Ball

Part Number	Ball Size	Compatible SUP's
RAP-B-379U-252050-KAY1	1" (B)	Connect SUP system
RAP-B-379U-M81208	1" (B)	Red Paddle Boards
RAP-379U-252050-KAY1	1.5" (C)	Connect SUP system



RAP-B-379U-252050-KAY1

Adhesive

Accommodating all 1" socket arms, this double-sided adhesive PSA stick pad is an excellent mounting solution for SUPs. Includes a sealed alcohol prep pad.

Base

Part Number	Ball Size	Diameter
RAP-B-378	1" (B)	2.5"



RAP-B-378

RAM® Twist-Lock™ Suction Cup

Use the RAM® Twist-Lock™ Suction Cup to secure your action camera or phone to your SUP. This popular solution provides a strong hold on non-porous surfaces.

Components

Part Number	Ball Size	Description
RAM-B-224-1	1" (B)	Suction cup base
RAP-350-35B	n/a	Flat adhesive disc



RAM-B-224-1



RAP-350-35B

Fishfinder Compatibility Chart

Part Number		Humminbird Helix 5	Humminbird Helix 7	Humminbird PiranhaMAX Series	Humminbird 500 Series	Humminbird 600 Series	Garmin Striker 4 & Striker Plus 4	Garmin Striker 5 & Striker Plus 5	Garmin Striker 7 & Striker Plus 7	Garmin echoMAP Chirp 42-55 Series	Garmin echoMAP Chirp 72-95 Series	Garmin GPSMAP 527	Garmin GPSMAP 547	Garmin ECHOMAP Plus 62cv	Garmin ECHOMAP Plus 63cv	Garmin ECHOMAP Plus 64cv	Garmin ECHOMAP Plus 65cv	Garmin GPSMAP 722xs	Garmin GPSMAP 742xs	Garmin GPSMAP 7607	Garmin GPSMAP 7608	Garmin GPSMAP 7407	Garmin GPSMAP 7408	Lowrance Elite-4	Lowrance Elite-5 Ti	Lowrance Elite-5 CHIRP Gold	Lowrance Elite-5 CHIRP	Lowrance Elite-7 Ti	Lowrance Elite-7 CHIRP	Lowrance HDS Carbon 7	Lowrance HOOK-3x	Lowrance HOOK-4	Lowrance HOOK-5	Lowrance HOOK-7	Lowrance HOOK ² -4 & 4x	Lowrance HOOK ² -5 & 5x	Raymarine Dragonfly 4, 5 & Wi-Fish	Raymarine Dragonfly 7 PRO	Raymarine Dragonfly 6 & 7											
Drill-Down Mounts	RAM-B-101-G4						•		•			•	•																																					
	RAM-B-111							•																																										
	RAM-111								•		•				•	•	•	•	•	•	•	•	X	X						•	•																			
	RAM-B-107				•	•																				•	•	•	•																					
	RAM-B-107-1			•																																														
	RAM-107																											•	•																					
	RAM-B-101-LO11																									•	•	•	•																					
	RAM-B-101-LO12																																																	
	RAM-101-LO11																											•	•																					
	RAM-202-153-202	•																																																
	RAM-202-24-202		•																																															
	RAM-101-RYM1																																															•		
	RAM-B-202-379-M616																																																	
	Track Mounts	RAM-202-24-354-TRA1		•																																														
		RAM-111B-354-TRA1							•	•		•				•	•	•	•	•	•	•	•	•	X	X					•	•																		
RAM-B-LO12-354-TRA1																																																		
RAP-B-202-LO11-354-TRA1																												•	•	•	•																			
RAP-B-107-1B-354-TRA1																																																		
RAP-B-107B-354-TRA1																																																		
RAP-B-111B-354-TRA1																																																		
RAP-B-202-153-354-TRA1			•																																															

X= Mounting plate will require modification to fit this device

Drawings Section

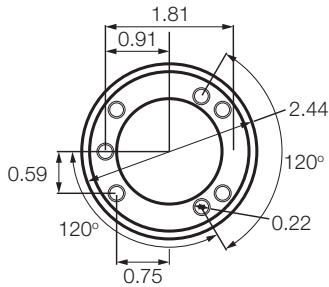

RAM-202

For: RAM-B-202, RAM-202, RAM-B-202-G2, RAM-202-G2U, RAM-B-202-G4U, RAM-202-G4, RAM-B-202-RYM1, RAM-202U-RYM1, RAM-B-101-G4, RAP-B-101U-G4, RAM-101-G4, RAM-101-RYM1 and RAM-B-101-RYM1

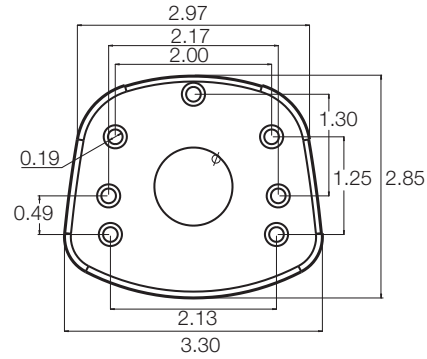

RAM-B-107-1B

For: RAM-B-107-1B, RAM-B-107-1

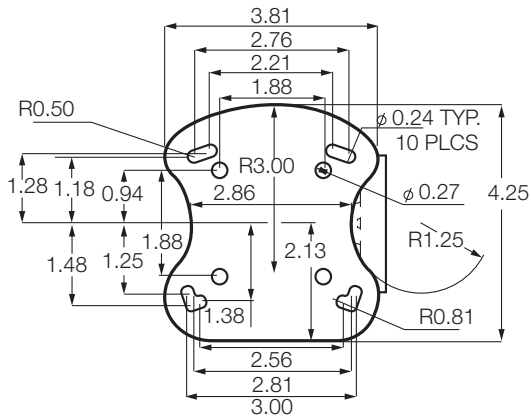

RAM-107B

For: RAM-B-107B, RAM-107B, RAM-B-107, RAM-107

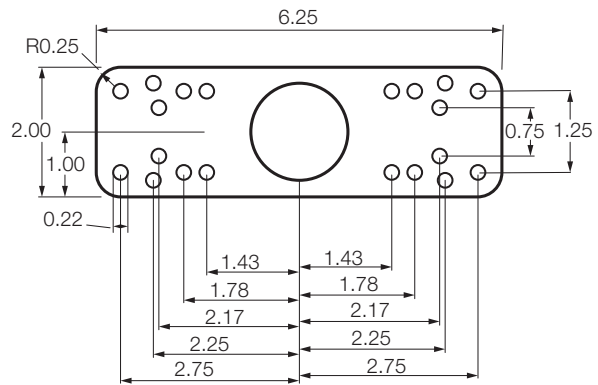

RAM-111B

For: RAM-111B, RAM-111-B, RAM-111, RAM-111-D, RAM-109H, RAM-109V, RAM-109H-1, RAM-109V-1

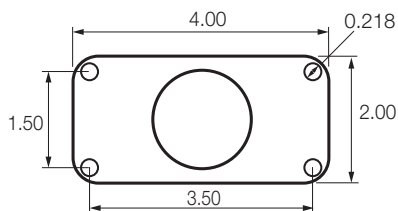

RAM-202U-24

For: RAM-B-202U-24, RAM-202U-24, RAM-202-24-B-202, RAM-202-24-202

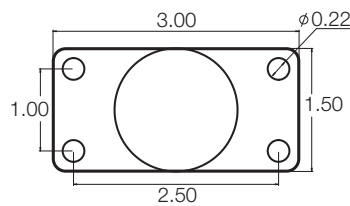

RAM-202U-153

For: RAM-B-202-153, RAM-202U-153, RAM-202-153-B-202, RAM-202-153-202

New Products

RAM® EZ-Roll'r™ Cradle for SPOT X™



RAM-HOL-SPO5U

RAM® Spine Mount for Garmin Handheld Devices



RAM-B-202-GA76U

RAM® Track-Node™



RAP-411

RAM® Bond-A-Base™ with Tough-Track™



RAP-398-GRY-TRACK-A

RAM® Double Ball Mount for Lowrance Hook² Series



RAM-101-LO12

RAM® Tough-Pole™ Track Mount with RAM® Track-Node™



RAP-411-18-A-GOP1-1

RAM ROD® HD



RAP-433-BMP

RAM ROD® JR



RAP-434-421

RAM® Roller-Ball™ Paddle Clip Base



RAP-412

RAM® Tough-Track™



RAM-TRACK-EXA-5U

The Shape That Started It All

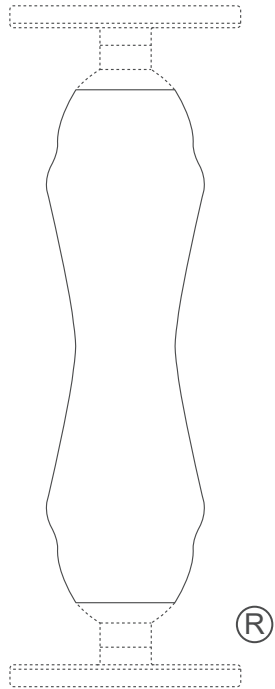

RAM® Mounts double socket arms—featuring a distinctive Hourglass Shape—are recognized globally as a symbol of durability, reliability, and quality. The Hourglass Shape is a registered trademark of National Products Inc.

The unique RAM® Mounts system offers a full line of interchangeable mounting bases, extensions, device adapters, and accessories to secure your gear where you want it. See all of the innovative products and solutions RAM® manufactures at rammount.com.

The unique RAM® Mounts system offers a full line of interchangeable mounting bases, extensions, device adapters and accessories to secure your gear where you want it. See all of the innovative products and solutions RAM® manufactures at rammount.com.



The distinctive RAM® “X-Grip®” product shape is a trademark of National Products Inc.



The distinctive “D” product shape of the GDS® connector is a trademark of National Products Inc.



RAM® Mounts is a division of National Products Inc.

8410 Dallas Avenue South

Seattle, WA 98108

Phone: 800.497.7479

sales@rammount.com

rammount.com

Lifetime Warranty

Patents and Trademarks

rammount.com/ip



RAM
MOUNTS



Contact Us

sales@rammount.com

1-800-497-7479

Join Our Community



NPI-CAT-PADDLESPORTS19
February 2019