

Operation and maintenance manual for **Lever hoist PREMIUM PRO**

Installation - Operation - Maintenance

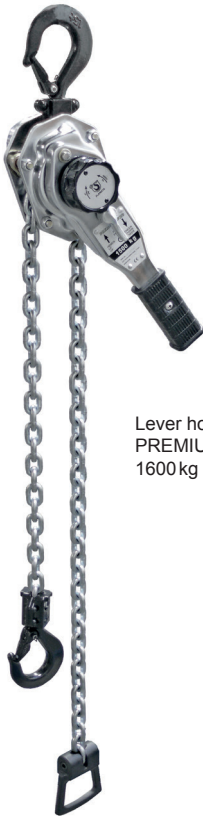

Lever hoist
PREMIUM PRO
1600 kg



Lever hoist
PREMIUM PRO
6400 kg

IMPORTANT - READ BEFORE USE!

PLANETA-Hebetechnik GmbH • Resser Str. 17 & 23 • D-44653 Herne
Tel. +49 2325 9580-0 • Fax +49 2325 77077 • info@planeta-herne.de • www.planeta-hebetechnik.de

© Reprint, also in extracts, only with written permission of PLANETA-Hebetechnik GmbH
01-01-09-0000-0215-00-BA-EN-PLA

Index















SAFETY

Generally

1. Introduction
2. Name plate
3. Safety remarks
4. General instructions about the safety
5. Operation
6. Installation
7. Operation Manual Lever Hoist PREMIUM PRO
8. Periodic inspections, Repair and Maintenance
9. Service
10. Technical Data Manual Lever Hoist PREMIUM PRO
11. Spare parts listing Manual Lever Hoist PREMIUM PRO
12. Test log book and annual UVV inspections

CE - DECLARATION OF CONFORMITY

SAFETY

				
<p>1. Read before use!</p>	<p>2. Do not overload</p>	<p>3. Do not work under a load!</p>	<p>4. Never pull the chain from the side!</p>	<p>5. Never work with a damaged hoist!</p>
				
<p>6. Never lift human with this hoist!</p>	<p>7. Never throw the hoist</p>	<p>8. Do not wrap the load chain around the load</p>	<p>9. NEVER extend the Hand lever with a pipe!</p>	<p>10. Never work up to the end of chain</p>
				
<p>11. Never attach the load on the tip of the hook!</p>	<p>12. Never work with a twisted or broken chain!</p>	<p>13. Never work without a safety latch!</p>	<p>14. Never remove the warning notice</p>	

Generally

Intellectual property

Hoist models, drawings and engineering are of our exclusive property. It is expressly forbidden to copy, use or hand over to third parties such information without a specific written permission.

Warranty

PLANETA warrants to the original user its hoists to be free of defects in material and workmanship for a period of one year from the date of purchase. PLANETA will repair, without cost, any product found to be defective, including parts and labor charges, or at its option, will replace such products or refund the purchase price less a reasonable allowance for depreciation, in exchange for the product.

If any product proves defective within its original one year warranty period, it should be returned to any authorized PLANETA dealer, transportation prepaid with proof of purchase or hoist data sheet / test certificate.

This warranty does not apply to products which PLANETA has determined to have been misused or abused, improperly maintained by the purchaser; or where the malfunction or defect can be attributed to the use of no genuine PLANETA parts. PLANETA makes no other warranty, and all implied warranties including any warranty of merchantability or fitness for a particular purpose are limited to the duration of the expressed warranty period as set forth above. PLANETA's maximum liability is limited to the purchase price of the product and in no event shall PLANETA be liable for any consequential, indirect, incidental, or special damages of any nature arising from the sale or use of the product, whether based on contract, tort, or otherwise.

1. Introduction

Some important points to start with: This manual provides instructions for safety and reliability of your hoist and trolley. It is not a substitute for the accident prevention regulations (UVV) of the German industrial injuries corporation or all the other numerous standards which are different in other countries. You have to know all these regulations when operating this hoist or trolley! We suppose that all these local rules will be substituted by European regulations since the E.C. has one common market. But the sense of any regulation is the same

To prevent accidents!

Please mind these regulations and warnings strictly! In the Federal Republic of Germany there are following important: The BGV D8, D6, BGR 258 and BGR A1 and The Directive 2006/42/ EC of the European Parliament and of the Council 2006/42/EG (EG Machinery Directive). PLANETA hoists and trolleys are intended to be safe and reliable assistants. For this reason, we have written this operation manual.

But it's only serving its purpose in the hands of the user.

It is worthless in a hidden file. If you need further copies, we shall be pleased to forward them. Mind these instructions also in regard of your purse: wrong maintenance, unproper use or accidents owing to miswatching of regulations exclude our guarantee and liability.

To maintain working safety, repairs may only be carried out by trained mechanics and only original PLANETA-spare parts should be used. It is important that only PLANETA-trained mechanics perform such repairs; they know which and when spare parts have to be changed. The installation of foreign spares is a safety risk and results in loss of guarantee.

2. Name plate

There are, of course, some spare parts with wear which have to be replaced after a longer operation period. We recommend to fill in at once the following table to assure that you get the correct parts in future. Mostly the lifting hoist or trolley has passed later a tough job and you cannot read the numbers or letters. Take the important data from the name plate or from your test certificate. Please use only our spare parts list to order parts and mention the correct spare part number.

Model	Serial-No.
Capacityt	Year
Liftm	Chainmm

Since the quality of the product is being continually improved and alterations or inventions should be latest state of art, changes of design are reserved by us without prior information. If this manual differs in unimportant points from the real version of your hoist, we kindly beg your pardon. The next print will include this modification. But if you mention us the serial number, year of manufacturing or other typical design details, we should be able to find out the proper part which you require. For further information in English language please order our English manual.

3. Safety remarks

Some works and some way of operations are not allowed with the chain hoist and trolley of any type because they may destroy the hoist or trolley or they can do invisible damage and a later sudden accident. They also will bring danger for life and health of the operator. So remind:

- Transportation of persons is strictly forbidden.
- Do not drive loads hanging in trolley hooks above persons.
- Do not pull attached loads under angle or aside. Only vertical lifting and lowering and horizontal movements are allowed.
- Do not try to force sticking loads.
- Do not attach overload willingly..
- Never leave a suspended load unattended.
- Never run chains over sharp edges and around corners. Use a sheave!
- Do not use lifting chain as a sling.
- Chain hoist with push or geared trolley has to be moved by hauling the hand chain or by pushing against the load or the bottle hook. Never pull or tear simply the hand chain.
- Don not drop a load into the slack chain or hook.

4. General instructions about the safety

We have pointed out already in the introduction how important it is to mind all points of this instruction. You should especially be aware of the regulations and laws in connection with the product liability and insurance requests.

- The Operation and maintenance manual has to be always in the near of the place of employment. It contains important and essential aspects and extracts from the relevant standards and precautions. Any non-observance of the guide lines and hints out of this manual may lead to injuries or even to the death of the user of hoist or other innocent persons.
- In addition to this operation and maintenance manual there are National standards, laws and common safety senses to mind and to follow. Have also pollution and accident prevention regulations in mind! It could also be your obligation to wear special protection suits or to use special tools and safety devices for handling of dangerous loads.
- Any working with this hoist and trolley assumes and implies the observance of the local accident prevention regulations and the consequently action according these regulations.
- Even then, following up all of this, there could be more danger from untrained or not special advised workers using this hoist/trolley not in the sense of its originated purpose. Please make sure that only people with education and clear senses will use it.
- Please add to this chapter the instructions given by your company, i.e. regarding daily inspections, test procedures, working processes, records, and all instructions you think that they are helpfull to prevent accidents.
- All staff who will work with this lifting equipment must read this booklet prior the use of the hoist, especially the chapter about the safety instructions. This is too late during the operation of the hoist! This is valid especially for the use of hoists only through inspection periods or when doing seldom maintenance work with the hoist.
- Responsible personal shall check frequently whether the staff working with the hoist is doing it in accordance with the safety instructions.
- The owner of the hoist or of the company and his management are responsible for the good condition and for completeness of all necessary safety devices at the hoist and that it is used only in a safe manner. The Test booklet must be properly held and it has to contain the anual inspection check. We recommend to sign a maintenance contract with PLANETA who can inspect, maintain and repair your equipment periodically.
- Please set any chain hoist or trolley out of order if a failure appears in function. Call for designated help!
- The personal who works with the hoist, shall not bear long open hair, loose suits or jewels including rings. That could effect danger of injuries or that something can be pulled into the hoist.
- Safety tags, stickers and other attached instructions at the hoists like name plates are not allowed to be replaced, removed or overpainted. All written, printed or stamped letters and safety instructions have to be held in good readable condition. Use grease or other protection if necessary!

- Important: If this hoist or this trolley was made for manual powered operation, you are not allowed to power it by a motorized device without prior allowance of the manufacturer.
For example: the use of an electric hand drilling machine is not allowed to be used at a reel chain wheel.

5. Operation

Test before use

- Please check whether the supplied hoist is in accordance with your purchase order, check completeness and tightness of all bolts and nuts.
- Make sure that there occurred no damages during transportation.
- Copy and write down the date from name plate into your operation manual after inspection of the hoist and trolley.
- Take fully care that the maintenance and operation manual is in reach of the personnel who works with the hoist or make sure that the supervisor has it at hand to instruct the personnel.
- Check or recalculate whether the supporting construction (beam, clamp etc) in which the trolley or hoist hangs is in full compliance with the necessary capacity. If you are in doubt, please call for help of a construction engineer for statics.
- Chain hoists hanging in a trolley or even incorporated in a trolley, are cranes. They have to comply with special standards and safety regulations (BGV D6 in Germany). They have to be checked by a "crane expert" prior use. We can help you with such an expert upon your request.

Installation hint

- Do not use the hoist and trolley without corrosion protection (grease) under free sky or leave it there.
- If it is necessary that the unit has to be used outside, we recommend to construct a little "hut" or only a roof like a "car port" to protect the unit against rain and other environed aggressive influences. A new PLANETA-hoist is not restricted in use outside or under the described conditions, but during the operations while chains move and wheels drive, there will be wear on metal parts where corrosion can take effect. This is not a warranty claim! Mainly high temperatures, high air moisture, acid atmospheres, poison steams or high dust pollution are the major reasons why a hoist can get wear and can get a shortened life time. Mechanical moving parts are mostly affected. Watch these parts generally and keep them greased and maintained whenever it seems to be necessary.
- When your unit will be used daily and it is important that it functions absolutely for sure, please buy a spare unit to have it at hand in case of trouble. This avoids down time in your production.
- Do not allow the unit and chain to be exposed to extremely cold whether. Do not apply loads to a cold chain. Temperatures below -20 degr. C or above +60 may decrease the safe working load. Call manufacturer if in doubt!

6. Installation

Prior delivery, all units have been lubricated, tested with full load and overload and they received a test certificate.

- Hang hoist with the clamp into the load carrying system and turn once.
- Hand chain and load chain must hang free and be without breaks or twists.
- Operate mechanism for lifting and lowering and carry out load-free test run with lifting and lowering.
- Inspection of load brake: Lift up lightly the load and hold it. If load is safe, go on lifting. When lowering, the load shall not slide after hand chain shutdown or stop of the lever movement at the lever hoist respectively.
- If everything is performed properly, operation can be started.
- Important for devices of multiple lines: Lower block shall not be snapped through the chain loop. This can be recognised by a twisted chain. Each second chain link is in one row not steadily in alignment. If the welded seams of the chain links are not in same direction the lower block must be struck back through the chain loop.
- The last chain link must be fastened on the cabinet.

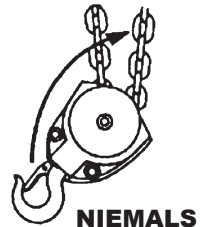

Indications for the lever hoist PREMIUM PRO

- The top load hook of the hoist must be secured fasten to the supporting part. Make sure that the safety latch is engaged.
- Don't use a hoist showing wear or damages.
- Inspect the hoist periodically and replace worn and damaged parts.
- Don't support any load with the tip of the hook. The hoist is very dangerous if you over load it.
When you feel the operation hand force is obviously bigger than the effort under lifting permissible capacity, you should stop the operation immediately and ask the technical personnel for checking. Because you could be in overloading or some parts have been damaged.
- Chain freewheel must be switched off before lifting.
- Never load the lever hoist with switched on free-wheel!
- Do not lift a load simultaneously with several lever hoists
- Click sound of safety catch is normal when the load is lifted.
- The brake grabs permanently – independent from traction direction (lifting or lowering)
Exception: In case of switched freewheel. – Never switch to freewheel under load!
- Never hang on the rubber protection handhold!

7. Operation manual lever hoist PLH premium PRO

- Fast shortening of load chain:
Turn change lever in central position and handwheel clockwise; or set control lever to LOWER. The brake is opened by fitful left-hand rotation of hand lever. Set control lever to and pull through chain with little manual force
- Lift/Pull/Clamp
For Lifting/Pulling/Clamping tighten load chain and set control lever to Lift, for lowering (or loosening during clamping) of load set control lever to LOWER.
- Operation by settled, continuous pump movements of device lever.
- Brake closes independently when hanging on the minimal load (appr. 10% of nominal load).



Warning: Do not attempt to select freewheel under load.

8. Inspections, Repair and Maintenance

When you detect during the disassembling of your hoist that some parts are worn or damaged, please replace them by original new parts. The name of the spare parts are found in the spare parts list and the spare parts drawings which are attached some pages later. Please mention the correct spare part number, the description and the capacity of the hoist. If you are in doubt, send defect part to us.

Chain and Hook Test

Demounting of the load chain (Item 44): Unload the device. Disassemble the chain end link (pos. 71) and put it aside. Pull out the chain by using the freewheel. Inspect the chain, the chain end link and the hook.

Please check the chain regularly at short intervals. Pay attention to wear, notches, sectional deviations, corrosion and other damage. Check if the chain is running properly on the chain sprocket as follows:

- The chains and clamps have to be inspected continuously!
Clean chain before inspection. Lubricate load chain from time to time a bit!
Never lubricate or grease the brake!
- Retracted chain shall not click under load.
- Check chain for tension! The internal length (t) of a worn chain link, smallest diameter of wire (D) and length of 11 chain links (a) are measured by a slide gage where the chain must be tightened firmly.
- Dimensions: If the deviations of measurement exceed the values (a) in the following table substitute chain immediately. Measure of diameter (D) shall not be underrun and the splitting (t) of the single link not be exceeded.

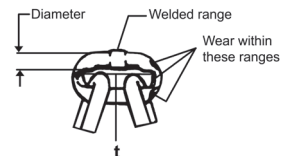

In case if the chain needs replacement it is assumed that the chain sprocket is also affected. This must also be checked for wear.

Hook test (pos. 45 and 50): Hooks can get bent or extended due to heavy loading and wrong handling of the equipment. The following table indicates when the hook needs replacement upon exceeding dimension “G”. If this is the case, then the overloading has also damaged other parts and the hoist needs to be checked thoroughly for deformations in all related components.

Because of the tolerances of the forged hooks, the actual dimension “G” has to be measured at the particular device by the operator and to be registered in the following list before bringing it into service.

Capacity	Max. Measurement of		Min. chain link diameter (D)
	1 chain link (t)	11 chain link (a)	
800 kg	18.0 mm	193.7 mm	5.0 mm
1600 kg	22.4 mm	237.9 mm	6.4 mm
3200 kg, 6400 kg, 9600 kg	29.4 mm	317.2 mm	9.0 mm

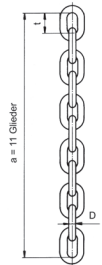

Capacity	Clamp mouth opening “G” normal – maximal
800 kg	31 mm – 34 mm
1600 kg	35 mm – 39 mm
3200 kg	45 mm – 50 mm
6400 kg	50 mm – 55 mm
9600 kg	50 mm – 55 mm

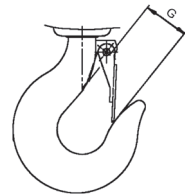
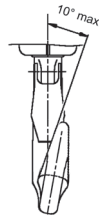

Measurement must be carried out as follows:

- Measure “G” from metal to metal in the hook opening, not including the hook safety latch.
- The abrasion of the hook surface should not exceed 10 % of the actual value.
- Determine the lateral torsion of the hook! In case of torsion exceeding 10 degrees beyond plane level, the hook must be replaced.
- Check the hook security catch for tight closure and smooth operation! If negative, replace!
- Excessive damage due to chemical or corrosive influences require replacement of the hooks. Do not repair a hook by welding or grinding!
- To check the hook for freedom from cracks, a fluorescent medium test is carried out. Cracked hooks need to be replaced.

These tests are to be carried out specialists for hoisting equipment only. In case of unavailability please contact your supplier or PLANETA. We perform such regular tests, also within the framework of Maintenance Agreement.

Disassembly of the brake: Please make use of the Spare Parts List!

Follow the sequence in the explosion representation and dismantle it from right to left.

Check lever handle, free knob, hand wheel, pawl, select lever, brake disks, ratchet wheel and feathers for deformation and wear as previously described under disassembly.

9. Service

After using the device please consider:

- Switch the selector lever to its middle position.
- Wipe off dust and water, grease chain and all rotating parts of the hook a little.
- Check for functional capability of the safety latch.

From time to time – dependent on the frequency of use – the lubrication of the gear wheels has to be checked.

Grease Directive:

Lubricate all movable parts (gear wheels etc.) with a thin layer of Molykote grease.

Exception: All parts of the brake system are not allowed to be greased!

When not in use hang the lever hoist at a dry place.

Please note that a faultless and safe use is only warranted with the use of original spare parts. If you want your device to be inspected or maintained within the warranty, please send it back in an assembled state.

Returns of devices in a disabled state void all warranty claims.

Expert inspection:

All PLANETA lever hoists are subject to the Regulations of the UVV/BGV D 8 and have to be inspected once a year by an expert. The entrepreneur has to proof the inspection.

10. Technical data manual Lever hoist PREMIUM PRO

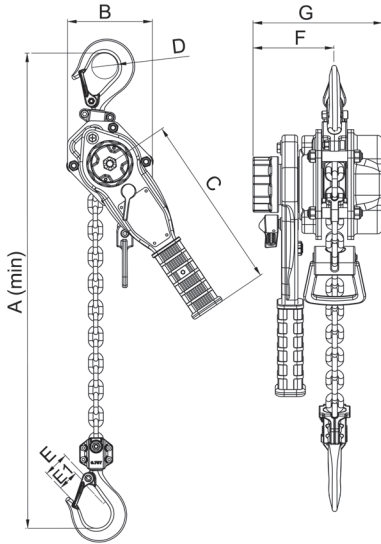

Lever hoist PREMIUM PRO 800 kg - 3200 kg

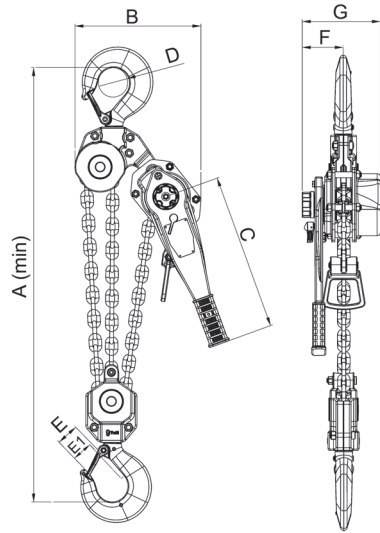

Lever hoist PREMIUM PRO 9600 kg

TYPE PREMIUM PRO...		0.8	1.6	3.2	6.4	9.6
Capacity	t	0.8	1.6	3.2	6.4	9.6
Standard lift	m	1.5	1.5	1.5	1.5	1.5
Min. headroom (A)	mm	320	360	431	500	635
Lever force	daN	22	24	33	36	38
Number of chain falls		1	1	1	2	3
Chain size	mm	5.6 x 17	7.1 x 21	9 x 27 Grad 100	9 x 27 Grad 100	9 x 27 Grad 100
B (Dimensions)	mm	115	137	169	238	300
C	mm	239	259	374	374	374
D	mm	35	42	48	60	70
E	mm	35	38	46	59	54
E'	mm	23	28.5	33	39	51
F	mm	91	67	98	98	98
G	mm	146	162	187	187	187
Weight with 1.5 m lift	kg	5.3	8.6	15.2	23	43
Weight for 1m add. lift	kg	0.7	1.1	1.8	3.6	5.4

Subject to technical modifications

11. Spare parts for Lever hoist PREMIUM PRO 800 kg - 9600 kg

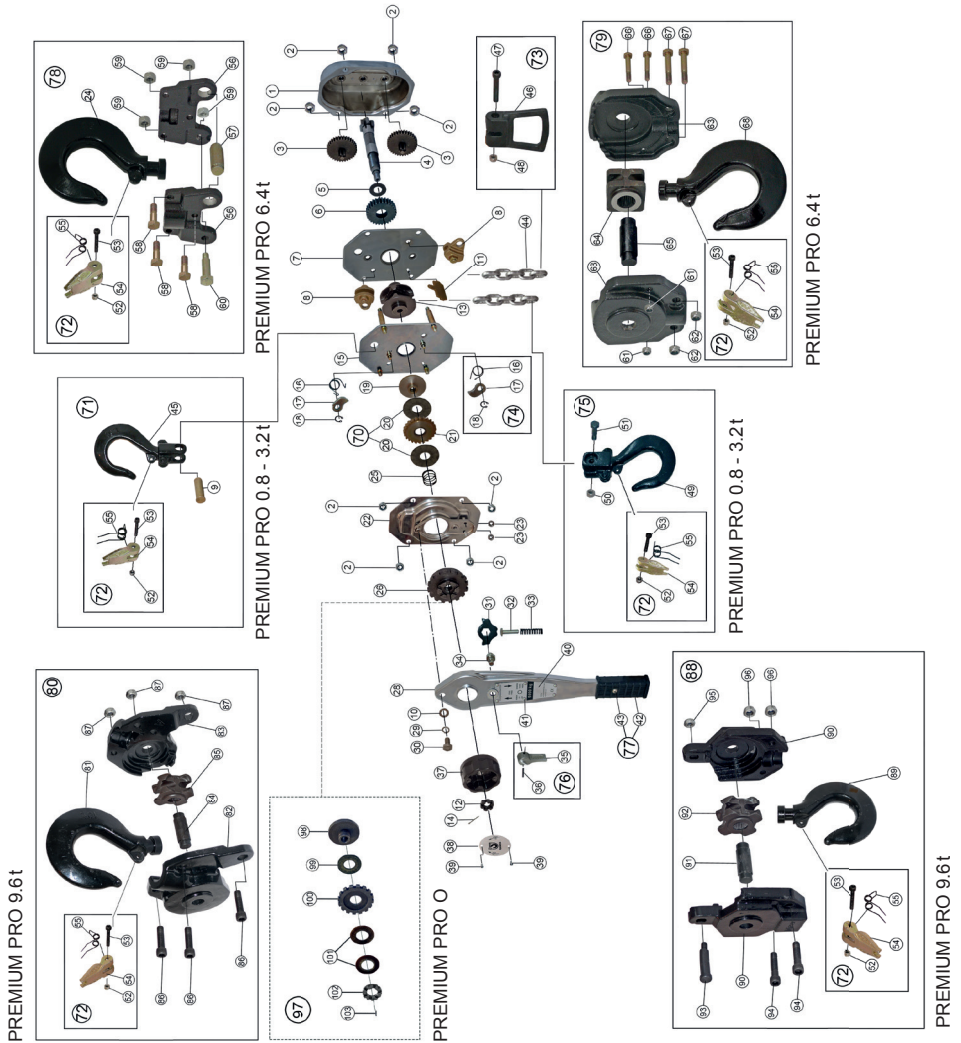

12. Spare parts listing for Lever hoist PREMIUM PRO 800 kg - 9600 kg

Component parts Lever hoist PREMIUM PRO 800kg

Item	Qty.	Description	Part-No.	
1	1	Cover	Z0100301	Stück
2	8	Hexagon nut	Z0100302	Stück
3	2	Driven shaft assembly	Z0100303	Stück
4	1	Drive shaft	Z0100304	Stück
5	1	Washer	Z0100305	Stück
6	1	Splined gear	Z0100306	Stück
7	1	Side plate assembly A	Z0100307	Stück
8	2	Chain guide	Z0100308	Stück
9	1	Top pin	Z0100309	Stück
10	1	Washer	Z0100310	Stück
11	1	Stripper	Z0100311	Stück
12	1	Castle nut	Z0100312	Stück
13	1	Load Chain sprocket	Z0100313	Stück
14	1	Split pin	Z0100314	Stück
15	1	Side plate assembly B	Z0100315	Stück
19	1	Disk hub	Z0100319	Stück
21	1	Ratchet disk	Z0100321	Stück
22	1	Brake cover assembly	Z0100322	Stück
23	2	Hexagon nut	Z0100323	Stück
25	1	Free spring	Z0100325	Stück
26	1	Change over gear	Z0100326	Stück
28	1	Lever handle	Z0100328	Stück
29	1	Spring washer	Z0100329	Stück
30	1	Screw	Z0100330	Stück
31	1	Change over pawl	Z0100331	Stück
32	1	Spring shaft	Z0100332	Stück
33	1	Change over sprin	Z0100333	Stück
34	1	Selector shaft	Z0100334	Stück
37	1	Hand wheel	Z0100337	Stück
38	1	Indicator cap	Z0100338	Stück
39	2	Screw	Z0100339	Stück
40	1	Name plate	Z0100340	Stück
41	6	Nameplate rivet	Z0100341	Stück
44	1,5	Load chain 5.6 x 17 mm	Z0100344	m

Complete parts Lever hoist PREMIUM PRO 800kg

Item	Qty.	Description	Part-No.	
70	1	Friction plates assy., Item. 20 (2x)	Z0100370	Set
71	1	Top load hook assy., Item. 9, 45, 72	Z0100371	Set
72	1	Safety latch assy., Item 52, 53, 54, 55	Z0100372	Set
73	1	Chain end link assy., Item 46, 47, 48	Z0100373	Set
74	2	Pawls assembly, Item 16, 17, 18	Z0100374	Set
75	1	Load hook assy., Item 49, 50, 51, 72	Z0100375	Set
76	1	Selector lever assy., Item 35, 36	Z0100376	Set
77	1	Rubber grip assy., Item 42, 43	Z0100377	Set
97	1	Overload protection assy., Item 98, 99, 100, 101 (2x), 102, 103	Z0100397	Set

Component parts Lever hoist PREMIUM PRO 1600 kg

Item	Qty.	Description	Part-No.	
1	1	Cover	Z0100401	Stück
2	8	Hexagon nut	Z0100402	Stück
3	2	Driven shaft assembly	Z0100403	Stück
4	1	Drive shaft	Z0100404	Stück
5	1	Washer	Z0100405	Stück
6	1	Splined gear	Z0100406	Stück
7	1	Side plate assembly A	Z0100407	Stück
8	2	Chain guide	Z0100408	Stück
9	1	Top pin	Z0100409	Stück
10	1	Washer	Z0100410	Stück
11	1	Stripper	Z0100411	Stück
12	1	Castle nut	Z0100412	Stück
13	1	Load Chain sprocket	Z0100413	Stück
14	1	Split pin	Z0100414	Stück
15	1	Side plate assembly B	Z0100415	Stück
19	1	Disk hub	Z0100419	Stück
21	1	Ratchet disk	Z0100421	Stück
22	1	Brake cover assembly	Z0100422	Stück
23	2	Hexagon nut	Z0100423	Stück
25	1	Free spring	Z0100425	Stück
26	1	Change over gear	Z0100426	Stück
28	1	Lever handle	Z0100428	Stück
29	1	Spring washer	Z0100429	Stück
30	1	Screw	Z0100430	Stück
31	1	Change over pawl	Z0100431	Stück
32	1	Spring shaft	Z0100432	Stück
33	1	Change over sprin	Z0100433	Stück
34	1	Selector shaft	Z0100434	Stück
37	1	Hand wheel	Z0100437	Stück
38	1	Indicator cap	Z0100438	Stück
39	2	Screw	Z0100439	Stück
40	1	Name plate	Z0100440	Stück
41	6	Nameplate rivet	Z0100441	Stück
44	1,5	Load chain 7.1 x 21 mm	Z0100444	m

Complete parts Lever hoist PREMIUM PRO 1600 kg

Item	Qty.	Description	Part-No.	
70	1	Friction plates assy., Item 20 (2x)	Z0100470	Set
71	1	Top load hook assy., Item 9, 45, 72	Z0100471	Set
72	1	Safety latch assy., Item 52, 53, 54, 55	Z0100472	Set
73	1	Chain end link assy., Item 46, 47, 48	Z0100473	Set
74	2	Pawls assembly, Item 16, 17, 18	Z0100474	Set
75	1	Load hook assy., Item 49, 50, 51, 72	Z0100475	Set
76	1	Selector lever assy., Item 35, 36	Z0100476	Set
77	1	Rubber grip assy., Item 42, 43	Z0100477	Set
97	1	Overload protection assy., Item 98, 99, 100, 101 (2x), 102, 103	Z0100497	Set

Component parts Lever hoist PREMIUM PRO 3200 kg

Item	Qty.	Description	Part-No.	
1	1	Cover	Z0100501	Stück
2	8	Hexagon nut	Z0100502	Stück
3	2	Driven shaft assembly	Z0100503	Stück
4	1	Drive shaft	Z0100504	Stück
5	1	Washer	Z0100505	Stück
6	1	Splined gear	Z0100506	Stück
7	1	Side plate assembly A	Z0100507	Stück
8	2	Chain guide	Z0100508	Stück
9	1	Top pin	Z0100509	Stück
10	1	Washer	Z0100510	Stück
11	1	Stripper	Z0100511	Stück
12	1	Castle nut	Z0100512	Stück
13	1	Load Chain sprocket	Z0100513	Stück
14	1	Split pin	Z0100514	Stück
15	1	Side plate assembly B	Z0100515	Stück
19	1	Disk hub	Z0100519	Stück
21	1	Ratchet disk	Z0100521	Stück
22	1	Brake cover assembly	Z0100522	Stück
23	2	Hexagon nut	Z0100523	Stück
25	1	Free spring	Z0100525	Stück
26	1	Change over gear	Z0100526	Stück
28	1	Lever handle	Z0100528	Stück
29	1	Spring washer	Z0100529	Stück
30	1	Screw	Z0100530	Stück
31	1	Change over pawl	Z0100531	Stück
32	1	Spring shaft	Z0100532	Stück
33	1	Change over sprin	Z0100533	Stück
34	1	Selector shaft	Z0100534	Stück
37	1	Hand wheel	Z0100537	Stück
38	1	Indicator cap	Z0100538	Stück
39	2	Screw	Z0100539	Stück
40	1	Name plate	Z0100540	Stück
41	6	Nameplate rivet	Z0100541	Stück
44	1,5	Load chain 9 x 27 mm Grad 100	Z0100544	m

Complete parts Lever hoist PREMIUM PRO 3200 kg

Item	Qty.	Description	Part-No.	
70	1	Friction plates assy., Item 20 (2x)	Z0100570	Set
71	1	Top load hook assy., Item 9, 45, 72	Z0100571	Set
72	1	Safety latch assy., Item 52, 53, 54, 55	Z0100572	Set
73	1	Chain end link assy., Item 46, 47, 48	Z0100573	Set
74	2	Pawls assembly, Item 16, 17, 18	Z0100574	Set
75	1	Load hook assy., Item 49, 50, 51, 72	Z0100575	Set
76	1	Selector lever assy., Item 35, 36	Z0100576	Set
77	1	Rubber grip assy., Item 42, 43	Z0100577	Set
97	1	Overload protection assy., Item 98, 99, 100, 101 (2x), 102, 103	Z0100597	Set

Component parts Lever hoist PREMIUM PRO 6400 kg

Item	Qty.	Description	Part-No.	
1	1	Cover	Z0100701	Stück
2	8	Hexagon nut	Z0100702	Stück
3	2	Driven shaft assembly	Z0100703	Stück
4	1	Drive shaft	Z0100704	Stück
5	1	Washer	Z0100705	Stück
6	1	Splined gear	Z0100706	Stück
7	1	Side plate assembly A	Z0100707	Stück
8	2	Chain guide	Z0100708	Stück
10	1	Washer	Z0100710	Stück
11	1	Stripper	Z0100711	Stück
12	1	Castle nut	Z0100712	Stück
13	1	Load Chain sprocket	Z0100713	Stück
14	1	Split pin	Z0100714	Stück
15	1	Side plate assembly B	Z0100715	Stück
19	1	Disk hub	Z0100719	Stück
21	1	Ratchet disk	Z0100721	Stück
22	1	Brake cover assembly	Z0100722	Stück
23	2	Hexagon nut	Z0100723	Stück
25	1	Free spring	Z0100725	Stück
26	1	Change over gear	Z0100726	Stück
28	1	Lever handle	Z0100728	Stück
29	1	Spring washer	Z0100729	Stück
30	1	Screw	Z0100730	Stück
31	1	Change over pawl	Z0100731	Stück
32	1	Spring shaft	Z0100732	Stück
33	1	Change over sprin	Z0100733	Stück
34	1	Selector shaft	Z0100734	Stück
37	1	Hand wheel	Z0100737	Stück
38	1	Indicator cap	Z0100738	Stück
39	2	Screw	Z0100739	Stück
40	1	Name plate	Z0100740	Stück
41	6	Nameplate rivet	Z0100741	Stück
44	3	Load chain 9 x 27 mm Grad 100	Z0100744	m

Complete parts Lever hoist PREMIUM PRO 6400 kg

Item	Qty.	Description	Part-No.	
70	1	Friction plates assy., Item 20 (2x)	Z0100770	Set
72	1	Safety latch assy., Item 52, 53, 54, 55	Z0100772	Set
73	1	Chain end link assy., Item 46, 47, 48	Z0100773	Set
74	2	Pawls assembly, Item 16, 17, 18	Z0100774	Set
76	1	Selector lever assy., Item 35, 36	Z0100776	Set
77	1	Rubber grip assy., Item 42, 43	Z0100777	Set
78		Top load hook assy., Item 24, 56 (2x), 57, 58 (3x), 59 (4x), 60, 72	Z0100778	Set
79		Load hook assy., Item 61 (2x), 62 (2x), 63 (2x), 64, 65, 66 (2x), 67 (2x), 68, 72	Z0100779	Set
97	1	Overload protection assy., Item 98, 99, 100, 101 (2x), 102, 103	Z0100797	Set

Component parts Lever hoist PREMIUM PRO 9600 kg

Item	Qty.	Description	Part-No.	
1	1	Cover	Z0100801	Stück
2	8	Hexagon nut	Z0100802	Stück
3	2	Driven shaft assembly	Z0100803	Stück
4	1	Drive shaft	Z0100804	Stück
5	1	Washer	Z0100805	Stück
6	1	Splined gear	Z0100806	Stück
7	1	Side plate assembly A	Z0100807	Stück
8	2	Chain guide	Z0100808	Stück
10	1	Washer	Z0100810	Stück
11	1	Stripper	Z0100811	Stück
12	1	Castle nut	Z0100812	Stück
13	1	Load Chain sprocket	Z0100813	Stück
14	1	Split pin	Z0100814	Stück
15	1	Side plate assembly B	Z0100815	Stück
19	1	Disk hub	Z0100819	Stück
21	1	Ratchet disk	Z0100821	Stück
22	1	Brake cover assembly	Z0100822	Stück
23	2	Hexagon nut	Z0100823	Stück
25	1	Free spring	Z0100825	Stück
26	1	Change over gear	Z0100826	Stück
28	1	Lever handle	Z0100828	Stück
29	1	Spring washer	Z0100829	Stück
30	1	Screw	Z0100830	Stück
31	1	Change over pawl	Z0100831	Stück
32	1	Spring shaft	Z0100832	Stück
33	1	Change over sprin	Z0100833	Stück
34	1	Selector shaft	Z0100834	Stück
37	1	Hand wheel	Z0100837	Stück
38	1	Indicator cap	Z0100838	Stück
39	2	Screw	Z0100839	Stück
40	1	Name plate	Z0100840	Stück
41	6	Nameplate rivet	Z0100841	Stück
44	3	Load chain 9 x 27 mm Grad 100	Z0100844	m

Complete parts Lever hoist PREMIUM PRO 9600 kg

Item	Qty.	Description	Part-No.	
70	1	Friction plates assy., Item 20 (2x)	Z0100870	Set
72	1	Safety latch assy., Item 52, 53, 54, 55	Z0100872	Set
73	1	Chain end link assy., Item 46, 47, 48	Z0100873	Set
74	2	Pawls assembly, Item 16, 17, 18	Z0100874	Set
76	1	Selector lever assy., Item 35, 36	Z0100876	Set
77	1	Rubber grip assy., Item 42, 43	Z0100877	Set
80	1	Top load hook assy., Item 72, 81, 82, 83, 84, 85, 86 (3x), 87 (3x)	Z0100880	Set
88	1	Load hook assy., Item 72, 89, 90 (2x), 91, 92, 93, 94 (2x), 95, 96 (2x)	Z0100888	Set
97	1	Overload protection assy., Item 98, 99, 100, 101 (2x), 102, 103	Z0100897	Set

10. Annual safety inspections

Type of test	Date	Name & Signature the examiner	Result



CE-Declaration of Conformity
in the sense of 2006/42/EC Guidelines, Appendix II A, 2004/108/EG,
Appendix I and 2006/95/EG, Appendix III

We herewith declare that the
PLANETA-Hebetechnik GmbH, Resser Straße 17, 44653 Herne

that the partly completed machinery
Lever hoist Model PREMIUM PRO
in payload range 800 kg – 9600 kg

which was developed for lifting and lowering of loads, in the standard version, including load capacity control and meets the basic requirements for the following EC directives, as applicable for the delivered scope:

EG-Maschinenrichtlinie 2006/42/EG

Authorized for the compilation of the relevant technical documentation

Dipl.-Ing. Matthias B. Klawitter, CE-Koordinator,
PLANETA-Hebetechnik GmbH, Resser Straße 17, 44653 Herne

Herne, 04.02.2015

PLANETA-Hebetechnik GmbH



Dipl.-Ing. Paul H. Klawitter
(General Manager)

For the completion, installation and commissioning according to the operating instructions is responsible

Location

Date

Person in charge

Company

Your responsible supplier