

- INSTRUCTION MANUAL -

PASSERELLE TABLE

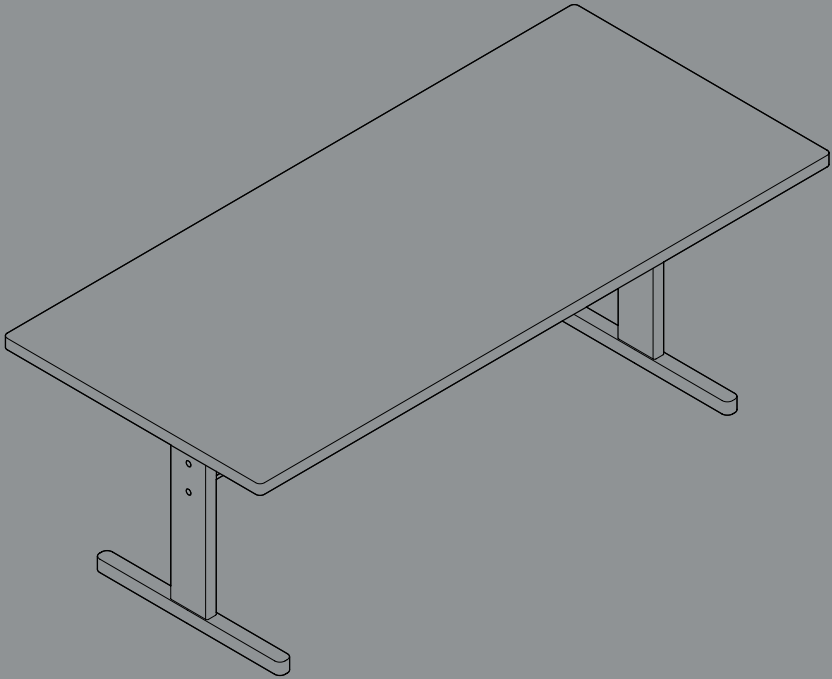

DESIGN BY RONAN & ERWAN BOURoulLEC

HAY

- PARTS -

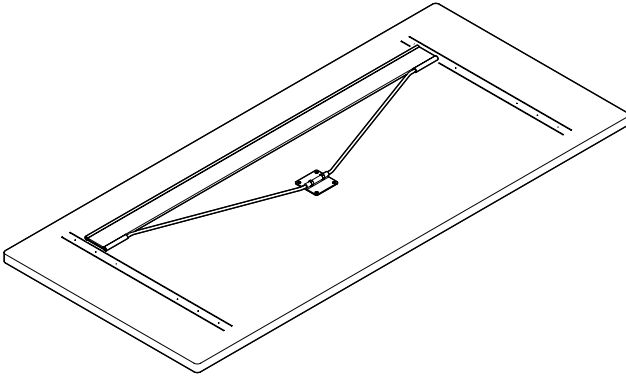

A Tabletop x1

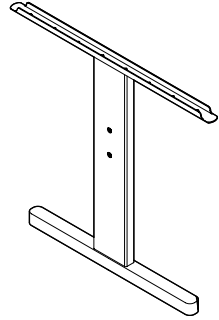

B Leg x2



C Screw x12

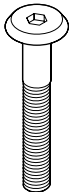

D Screw x4

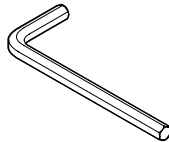

E Allen key x1



F Wrench x1

Protect the tabletop from scratches and other damage while assembling.

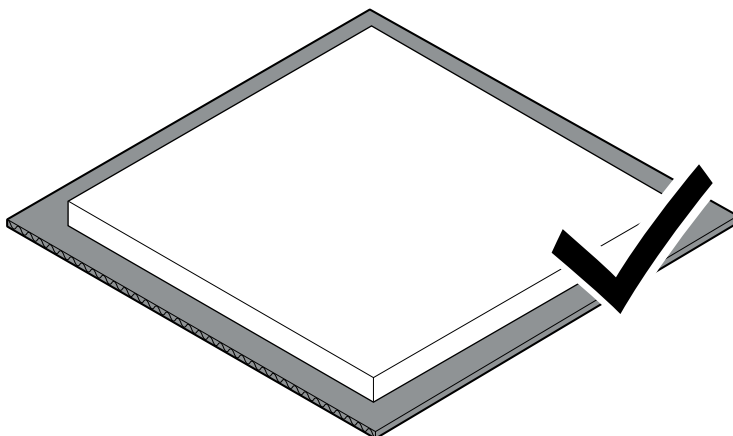
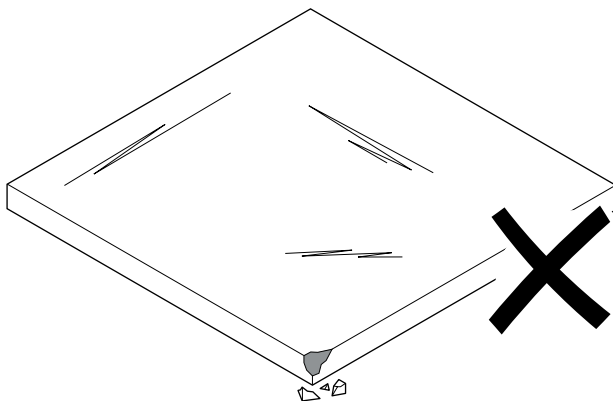

1.

Mount one leg **B** to the tabletop **A**. Fasten it with screws **C** using the Allen key **E**.
First mount all the screws loosely, before tightening them all completely.

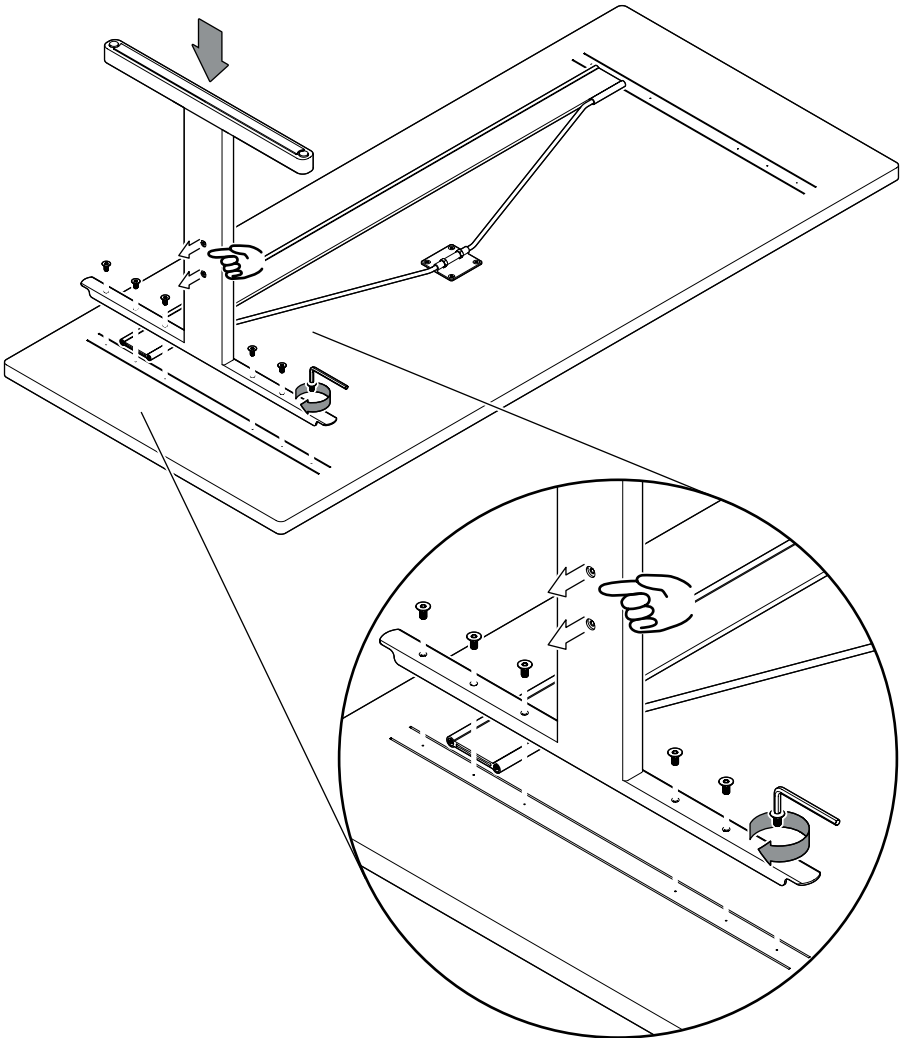

2.

Flip up the cross bar.

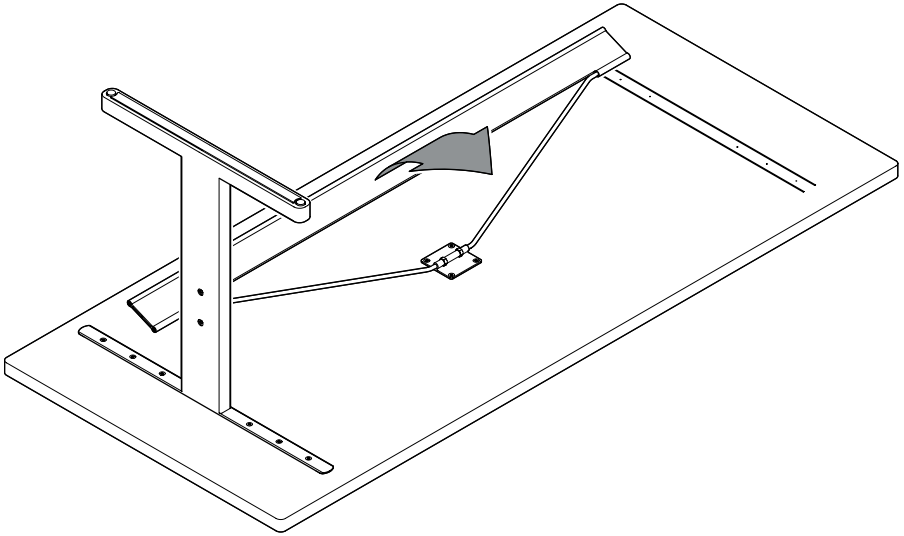

3.

Secure the cross bar with screws **D**.

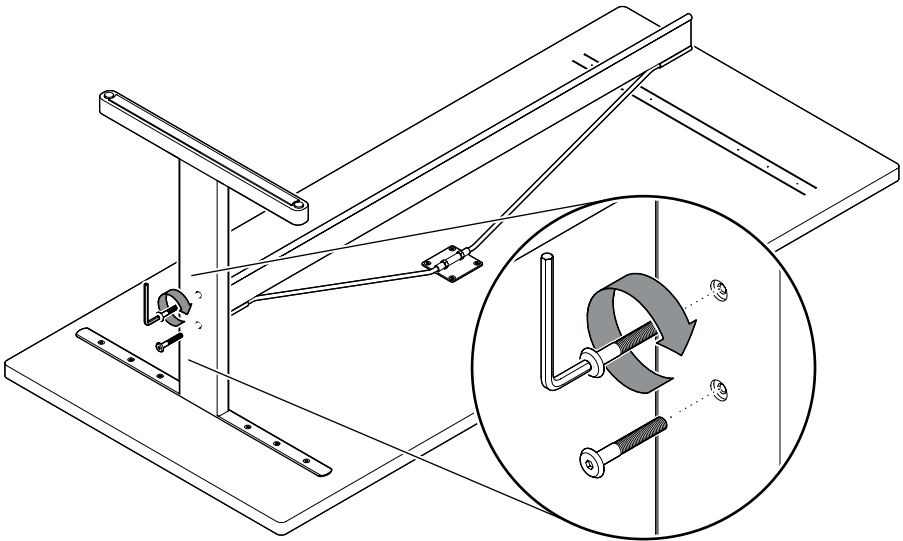

4.

Mount the other leg **B** and fasten with screws **C** using the Allen key **E**.
First mount all the screws loosely, before tightening them all completely.

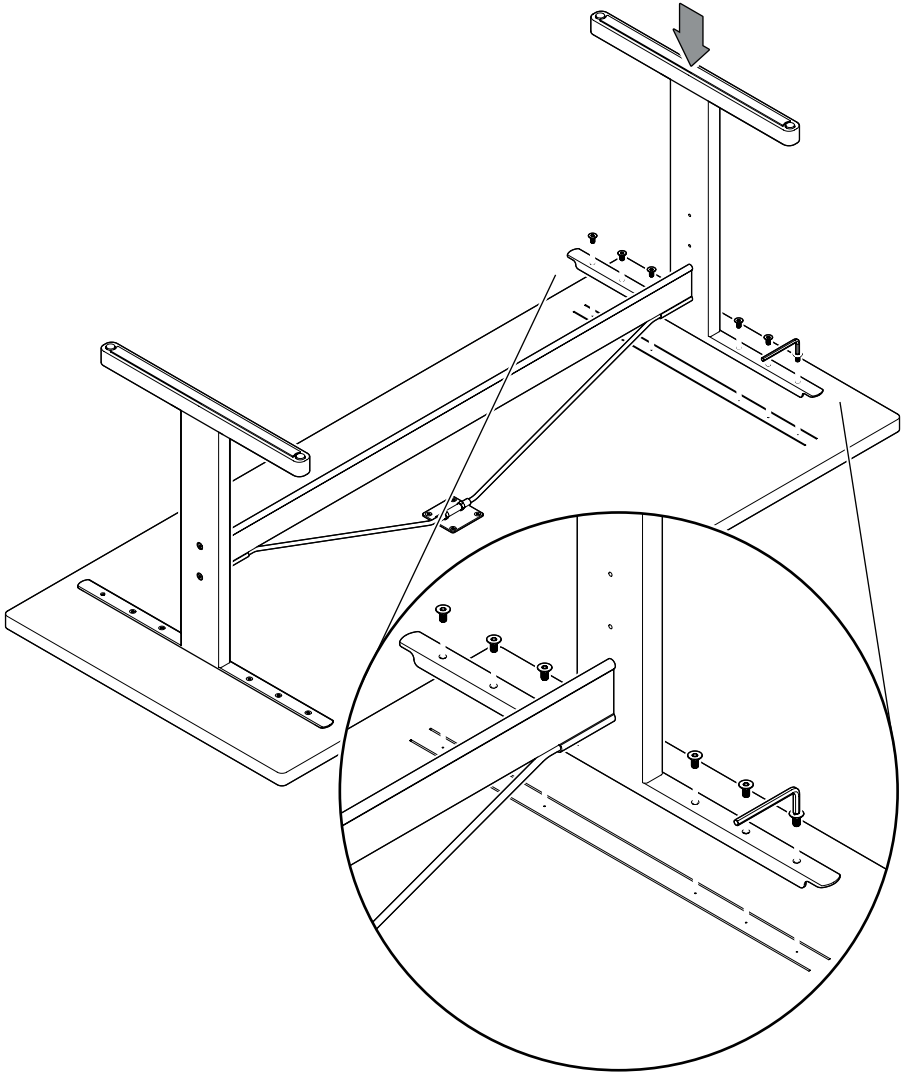

5.

Align the cross bar with the holes in the leg section. Secure with screws **D**.

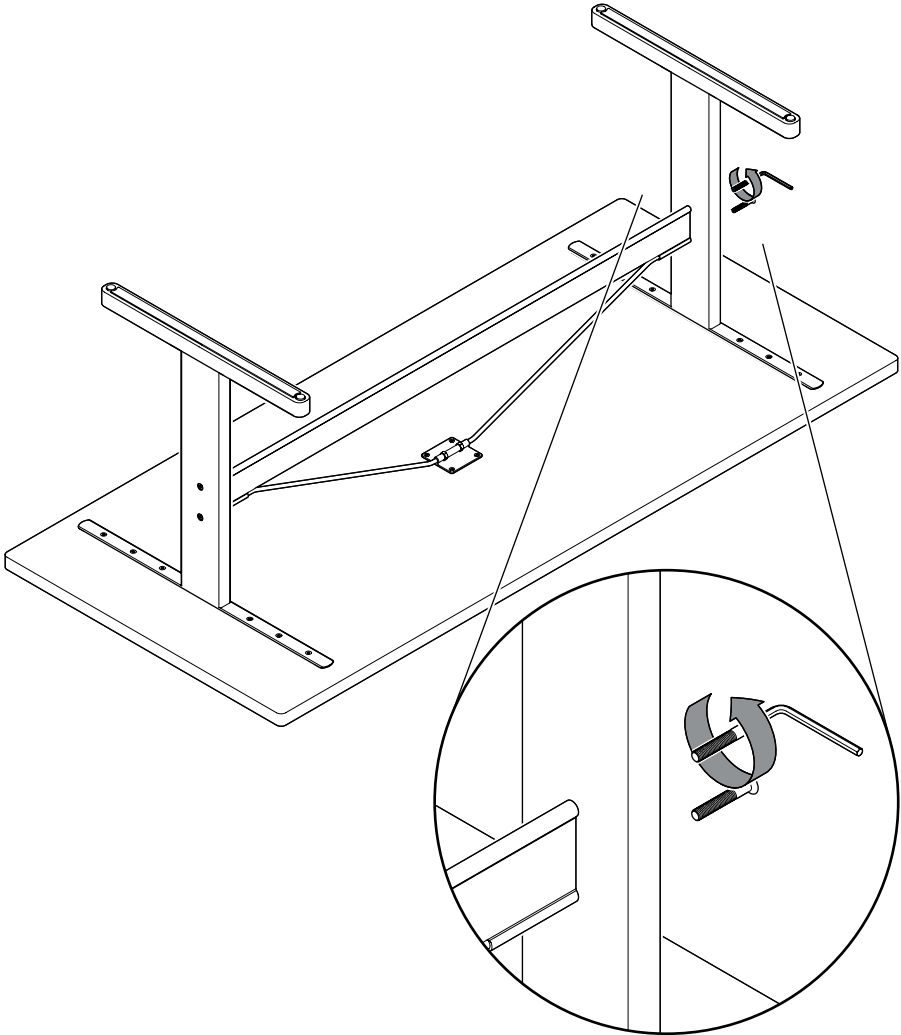

6.

Use the wrench **F** to adjust the tabletop and make sure it is level.

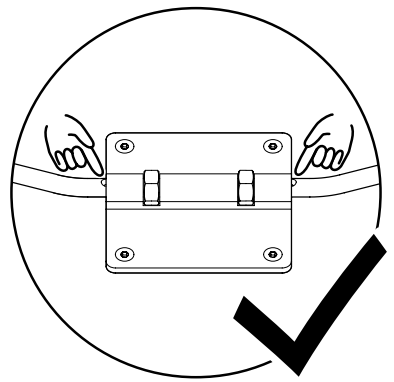
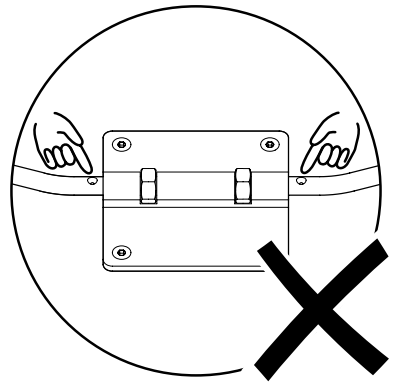
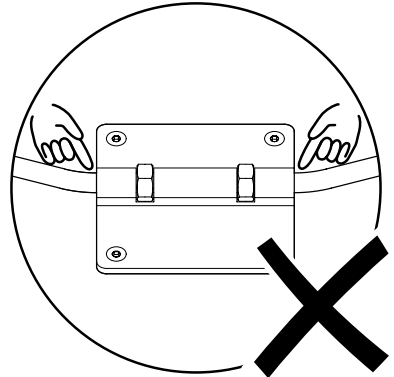
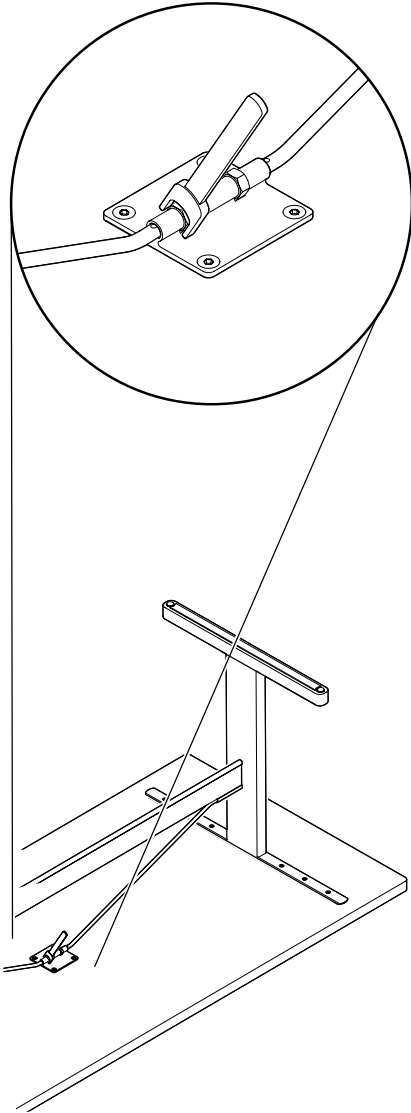

7.

Tightening or loosening the nuts brings the support rods in or out, which pushes the tabletop down or up.

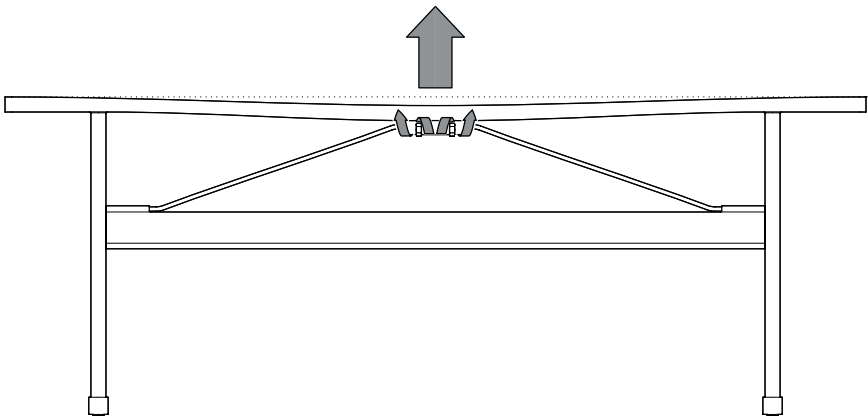
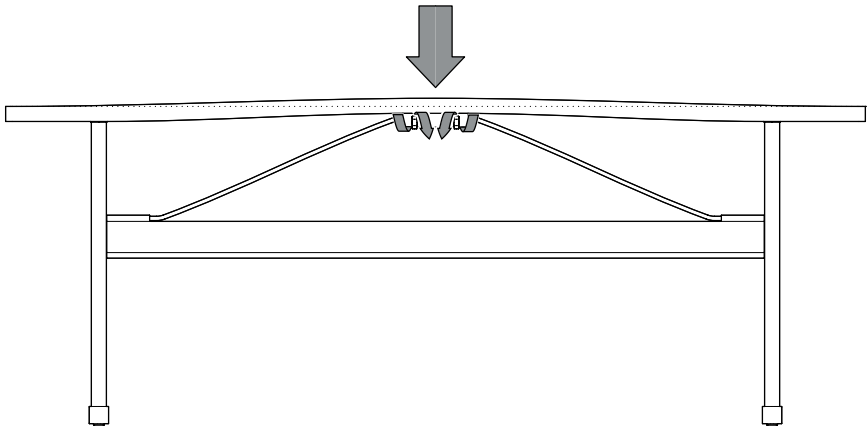
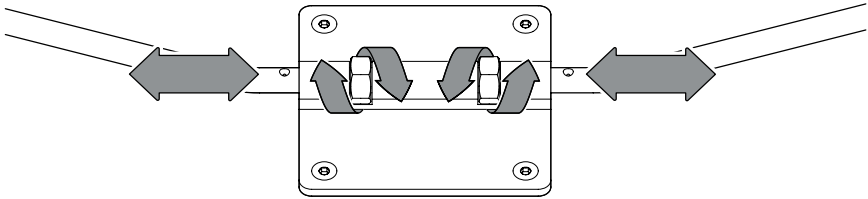

8.

If the floor is uneven, adjust the feet to make the table stable.

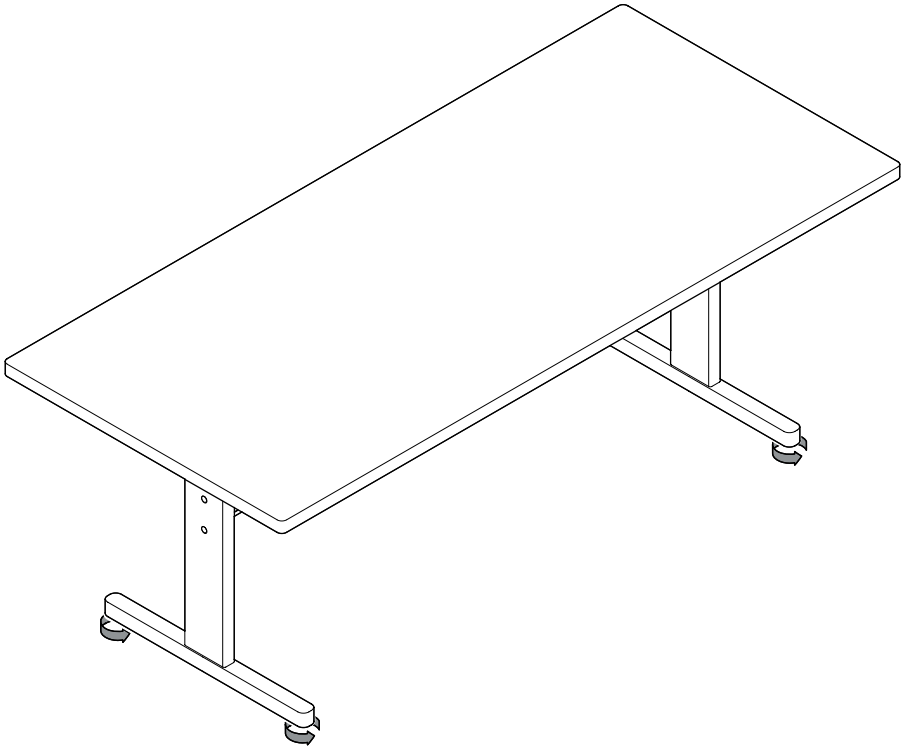

- CARE & MAINTENANCE -

Our Care & Maintenance offers guidance for optimal maintenance of your HAY product. It includes advice and instructions on cleaning and caring for specific materials to prolong the life of your furniture.



Please find our Care & Maintenance guide by scanning the QR code



You can find more relevant information on Passerelle Table by scanning the QR code

You can also find the same information here
hay.dk/downloads

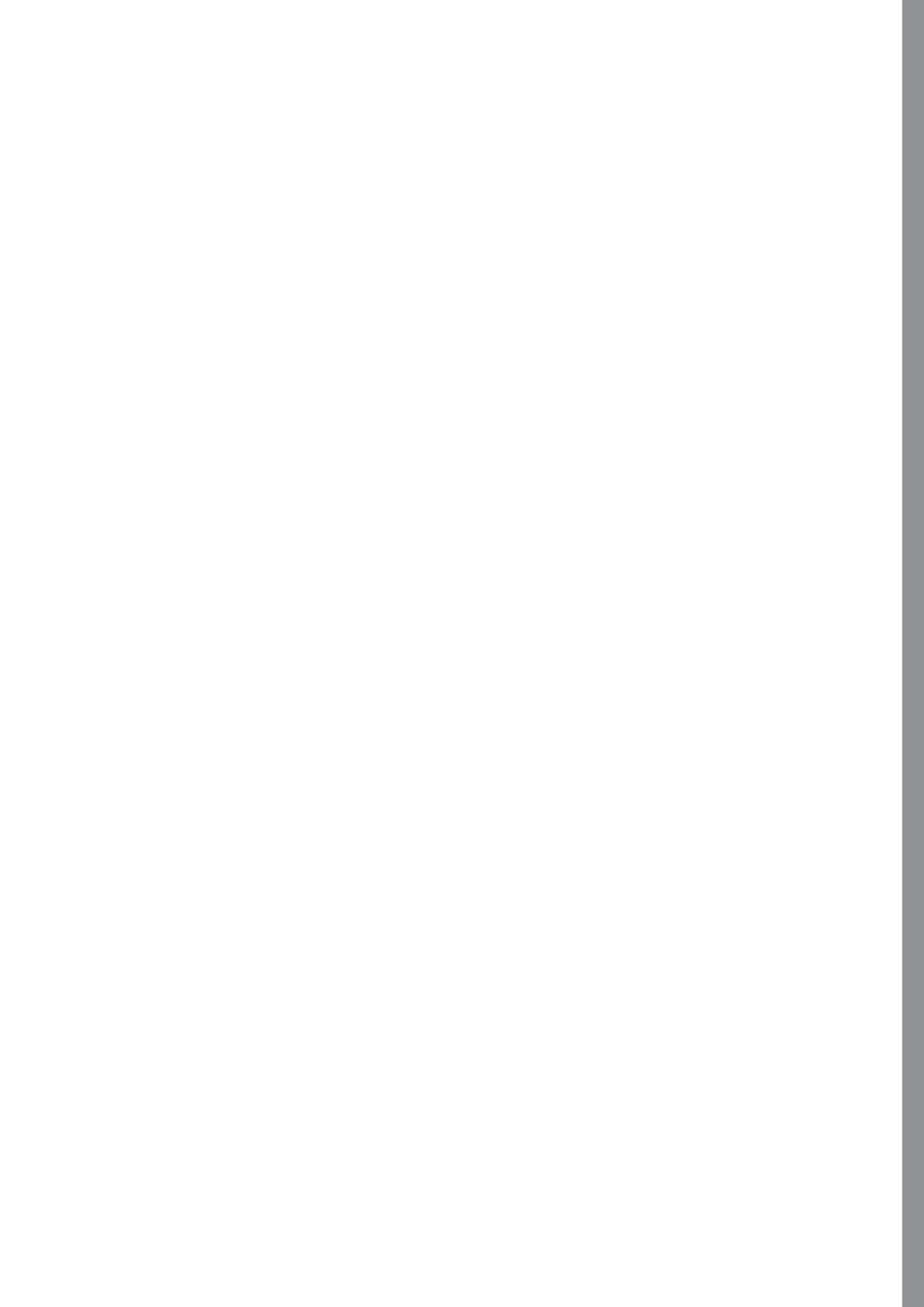

Havnen 1 8700 Horsens Denmark
+45 3164 6000 / hay@hay.com

10/01/2023

HAY