

- INSTRUCTION MANUAL -

PANDARINE

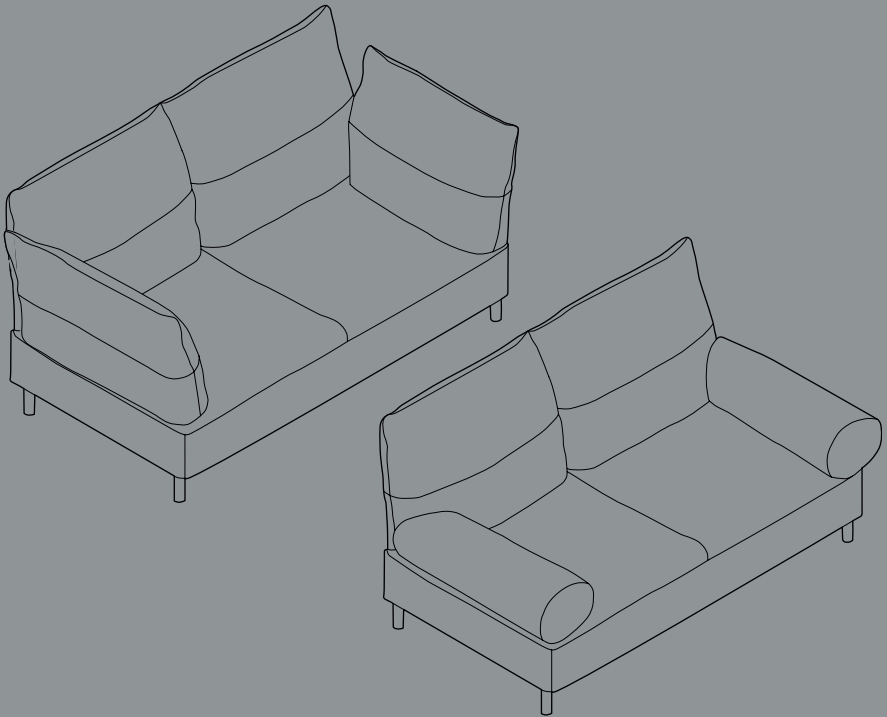

DESIGN BY INGA SEMPÉ

HAY

- PARTS -

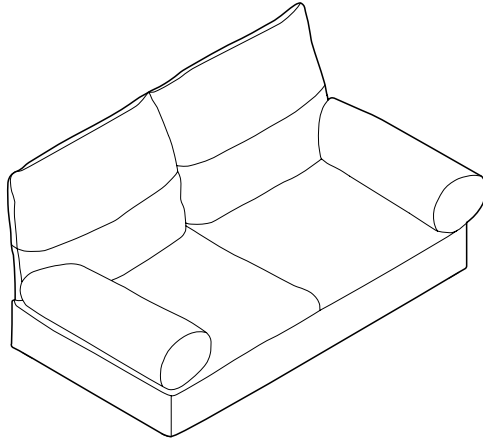

A Sofa module

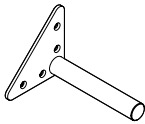

B Leg



C Leg sleeve



D Screw

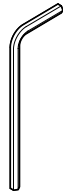

E Allen key x1

1.

Mount the legs **B** using the screws **D** and Allen key **E**.
The below diagram shows placement of legs, with the legs indicated by black dots.

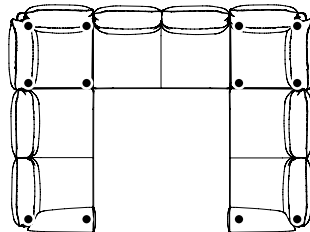
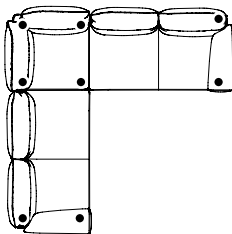
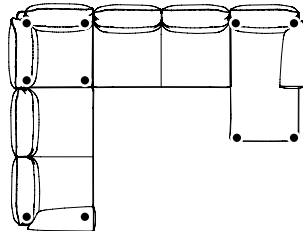
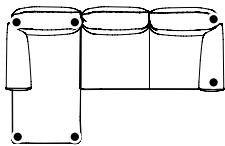
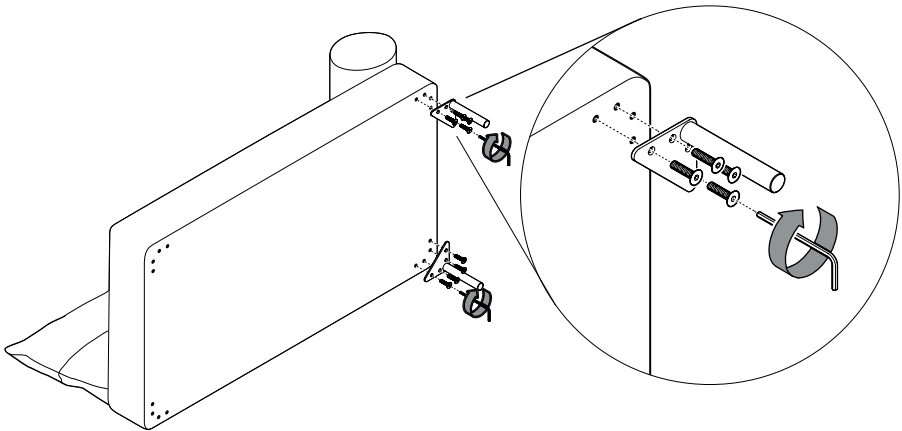

Examples of placements of legs.

2.

Mount the sleeve **B** by simply sliding it onto the leg. Make sure the seam is facing towards the middle of the sofa to minimise its visibility. If your sofa consists of several modules, assemble them by interlocking the two brackets together. Make sure to push the two parts of the sofa together while pushing down.

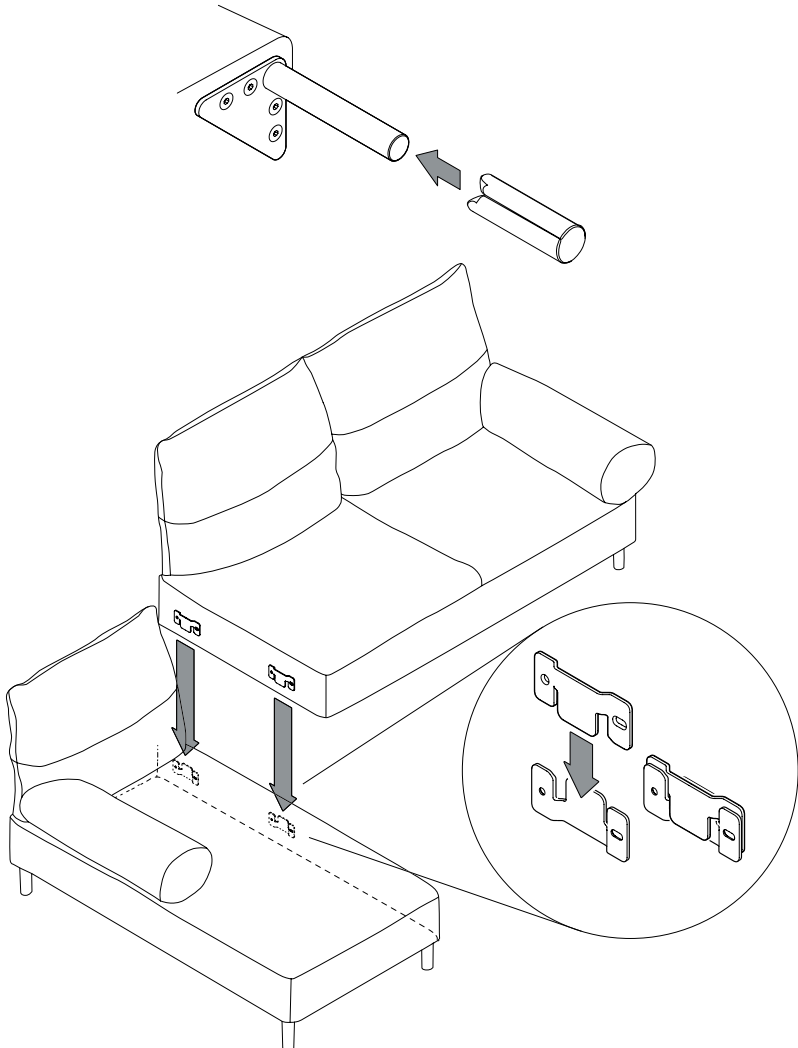

3.

Done!

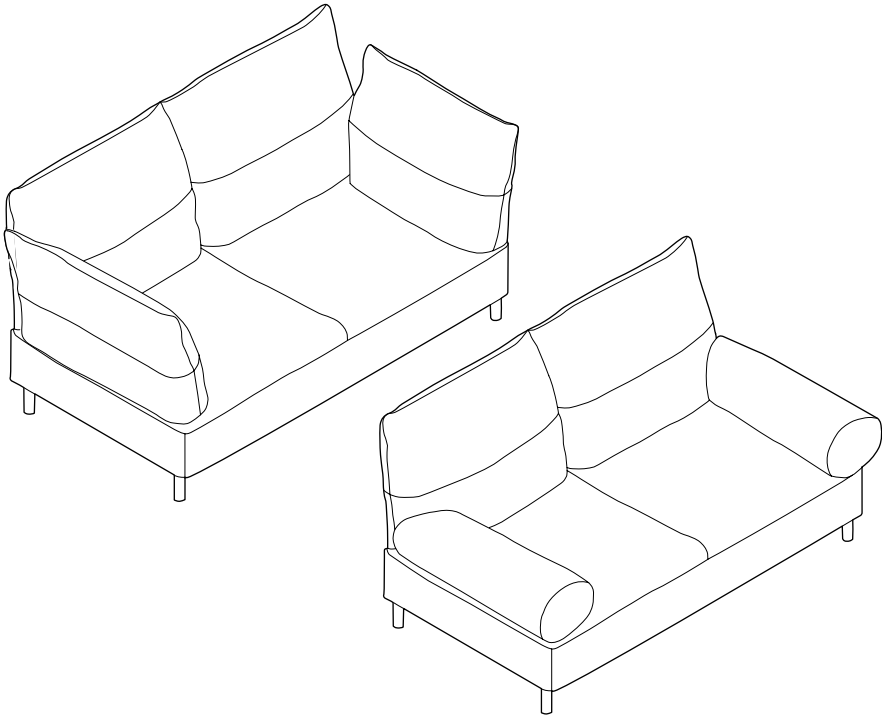

- MAINTENANCE -

Over time, your sofa will need some attention to ensure that the cushions remain plump and the seat cushion keeps its shape. To ensure that the cushion filling is spread evenly, follow these steps to plump the cushions. Repeat regularly when needed. More information on your specific fabric is to be found under the Care and Maintenance section.

PLUMPING CUSHIONS

Start from the bottom of the cushions and pull your hands up, while applying pressure.

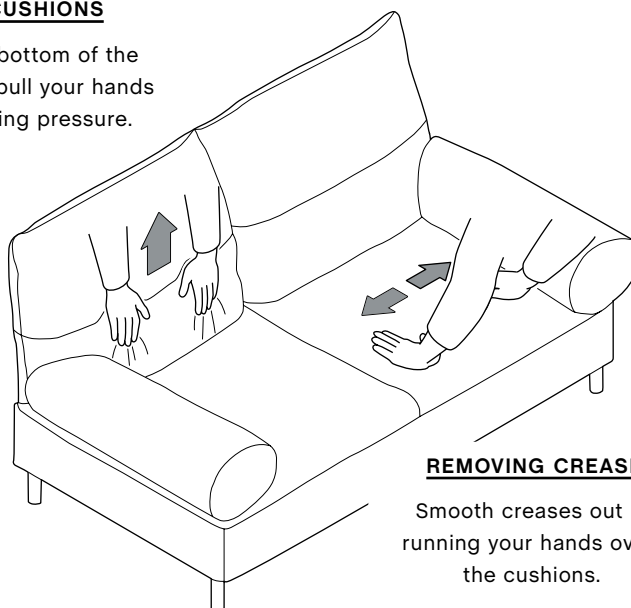

REMOVING CREASES

Smooth creases out by running your hands over the cushions.

- FUNCTION -

By pushing down on the backrest, you can tilt it backwards. To reset its position, simply lift it back up while holding one hand on the front of the cushion. This function is also available on reclining armrests.

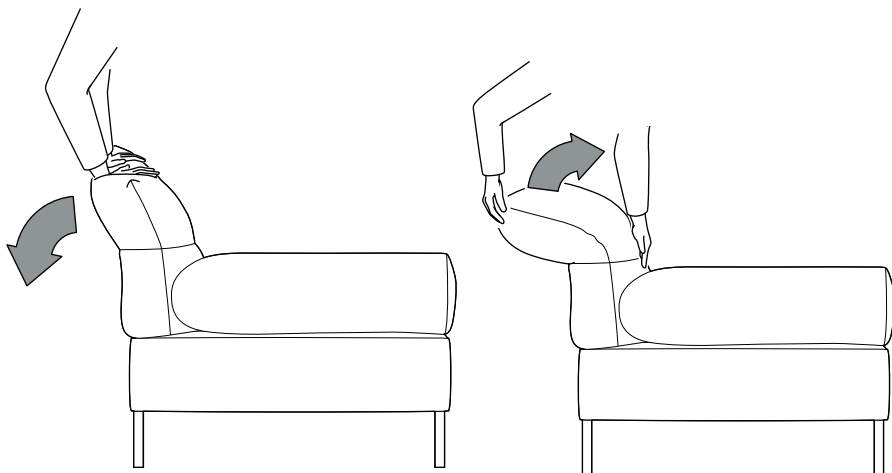

Backrest

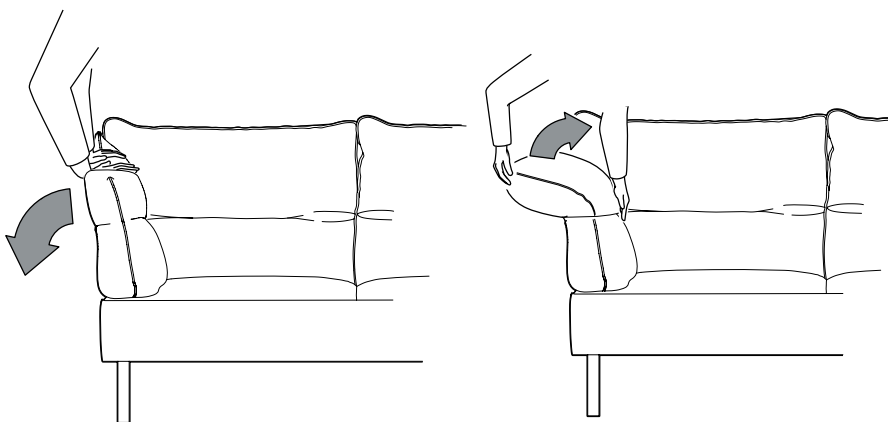

Armrest

- CARE & MAINTENANCE -

Our Care & Maintenance offers guidance for optimal maintenance of your HAY product. It includes advice and instructions on cleaning and caring for specific materials to prolong the life of your furniture.



Please find our Care & Maintenance guide by scanning the QR code



You can find more relevant information on Pandarine by scanning the QR code

You can also find the same information here
hay.dk/downloads

Havnen 1 8700 Horsens Denmark
+45 4282 0282 / hay@hay.com

29/10/2021

HAY