

LIGHTING COLLECTION



NEW PERSPECTIVES ON SCANDINAVIAN DESIGN

Muuto is rooted in the Scandinavian design tradition characterized by enduring aesthetics, functionality, craftsmanship and an honest expression.

By expanding this heritage with forward-looking materials, techniques and bold creative thinking, our ambition is to deliver new perspectives on Scandinavian design.

In fact our name, Muuto, comes from muutos, meaning new perspective in Finnish. We handpick leading contemporary designers who are strong interpreters of our philosophy and combine their talents with the passionate Muuto creative team.

Working across table lamps, floor lamps, pendants and wall lamps, our collection of lighting is designed with forward-thinking functionalities at its heart, allowing you to adjust each design to the unique atmosphere of any space, paired with a timelessly modern sentiment that'll shine through, even when not in use.

These are our new perspectives on modern lighting.



Rime Pendant Lamp
by TAF Studio

4	Overview
6	Inspiration
16	Strand Pendant Lamp
18	Rime Lamp Series
22	Post Lamp Series
24	Linear Lamp Series
28	Ambit Lamp Series
32	Grain Pendant Lamp
33	Beam Table Lamp
34	Tip Lamp Series
38	E27 Pendant Lamp
40	Unfold Pendant Lamp
42	Under The Bell Pendant Lamp
44	Fluid Pendant Lamp
46	Leaf Lamp Series
48	Pull Floor Lamp
50	Focus Table Lamp
51	Cosy in Grey Table Lamp
52	Control Table Lamp
54	General Information
56	Prices

Overview – Muuto Lighting Collection

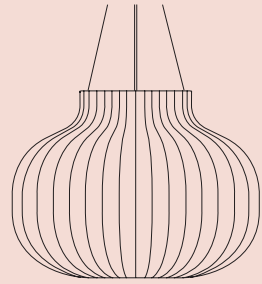

STRAND PENDANT LAMP
Closed Ø 80 cm

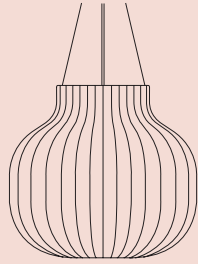

STRAND PENDANT LAMP
Closed Ø 60 cm

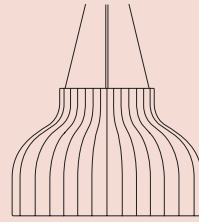

STRAND PENDANT LAMP
Open Ø 60 cm

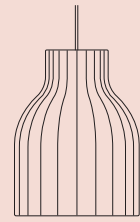

STRAND PENDANT LAMP
Open Ø 40 cm



STRAND PENDANT LAMP
Open Ø 28 cm

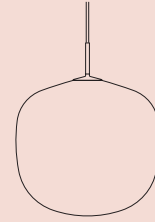

RIME PENDANT LAMP
Ø 45 cm

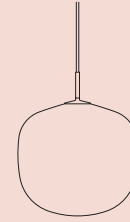

RIME PENDANT LAMP
Ø 37 cm

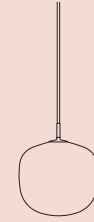

RIME PENDANT LAMP
Ø 25 cm



RIME PENDANT LAMP
Ø 12 cm



RIME WALL LAMP
L 23 cm

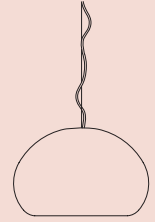

FLUID PENDANT LAMP
Ø 42 cm



FLUID PENDANT LAMP
Ø 23 cm

4



LINEAR PENDANT LAMP
L 169,2 cm

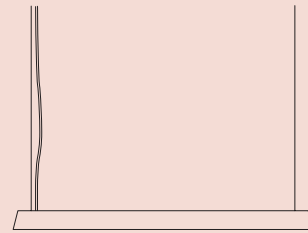

LINEAR PENDANT LAMP
L 87,2 cm



LINEAR TABLE LAMP
H 36,5 cm

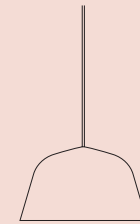

AMBIT PENDANT LAMP
Ø 40 cm

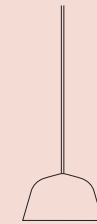

AMBIT PENDANT LAMP
Ø 25 cm



AMBIT PENDANT LAMP
Ø 16,5 cm

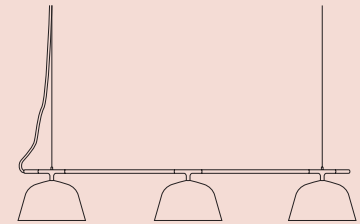

AMBIT RAIL LAMP
L 126 cm

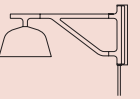

AMBIT WALL LAMP
L 40,7 cm

5

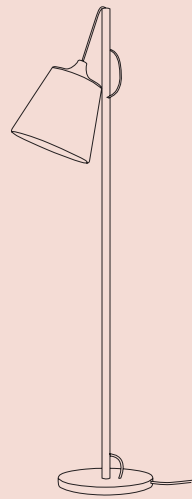

PULL FLOOR LAMP
H 150 cm

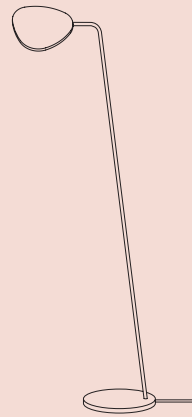

LEAF FLOOR LAMP
H 118 cm



LEAF TABLE LAMP
H 41,5 cm

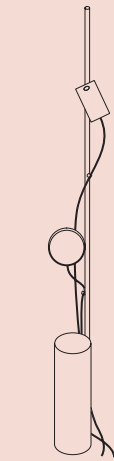

POST FLOOR LAMP
H 136,2 cm



POST TABLE LAMP
Ø 9,5 cm



TIP FLOOR LAMP
H 110,8 cm

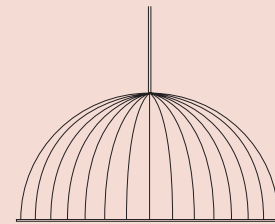

UNDER THE BELL PENDANT LAMP
Ø 82 cm

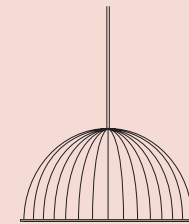

UNDER THE BELL PENDANT LAMP
Ø 55 cm



E27 PENDANT LAMP
Ø 12,5 cm



GRAIN PENDANT LAMP
Ø 21 cm

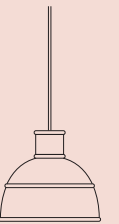

UNFOLD PENDANT LAMP
Ø 32,5 cm



TIP TABLE LAMP
H 40 cm



TIP WALL LAMP
Ø 9,5 cm



CONTROL TABLE LAMP
H 21,5 cm

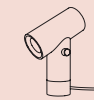

BEAM TABLE LAMP
H 26,2 cm



COSY IN GREY LAMP
H 32 cm



FOCUS TABLE LAMP
H 29 cm

“The Strand Pendant Lamp is designed in a unique cocoon material that filters light through for a comfortable glow, paired with its elegant shapes.”

– Benjamin Hubert

Strand Pendant Lamp
by Benjamin Hubert



6

Muto Lighting



Tip Floor Lamp
by Jens Fager

7

Muto Lighting



Post Floor & Wall Lamp
by Earnest Studio



Rime Pendant Lamp
by TAF Studio

Tip Table Lamp
by Jens Fager



IO
Muto Lighting
II
Muto Lighting

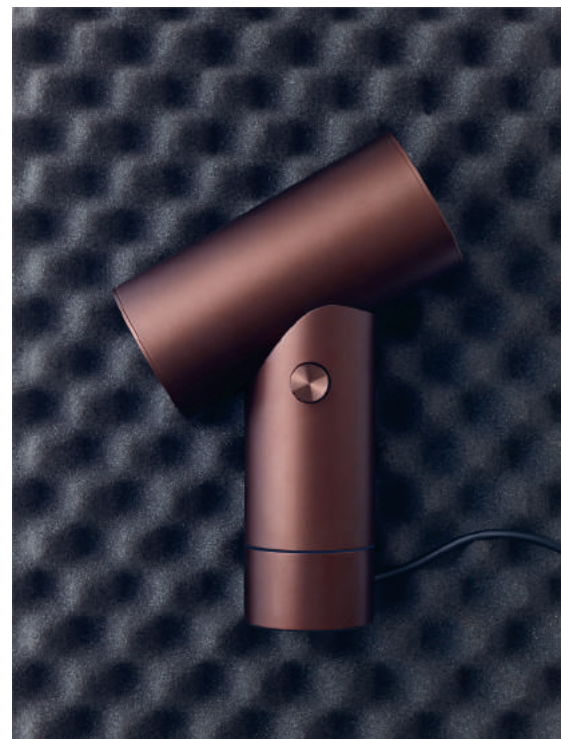

Beam Table Lamp
by Tom Chung

“The idea for Beam was to give as many possibilities for lighting control as possible while offering a poetic and interactive experience of light.”

– Tom Chung



Unfold Pendant Lamp
by Form Us With Love



Rime Pendant Lamp
by TAF Studio

“The Post Floor Lamp came from the idea of exploring the flexibility of the magnetic joint, giving the user the freedom to position and dim the lamp’s light units according to individual needs.”

– Earnest Studio

Post Floor Lamp
by Earnest Studio



14

Muto Lighting



15

Muto Lighting

Strand Pendant Lamp
by Benjamin Hubert

With its cocoon material filtering light through for a warm, comfortable glow, the Strand Pendant Lamp hovers almost cloud-like in space, bringing comfort, harmony and a refined sensitivity to any room.



STRAND PENDANT LAMP

by Benjamin Hubert

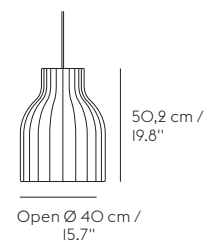
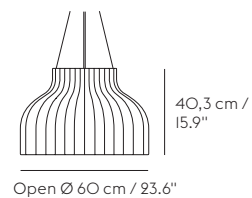
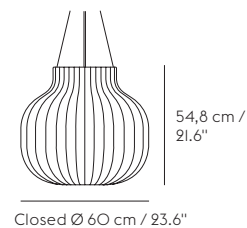
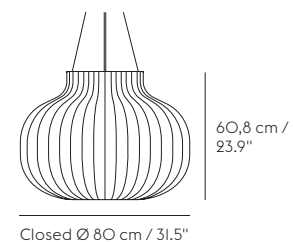

17

Muuto Lighting

MATERIAL

Steel structure covered with cocoon material. PVC cord, PVC covered steel wire

LIGHT SOURCE

Ø80 – EU/US: E27/E26, max. 60W Incandescent, 18W SBCFL or 18W SBLED. Recommended light source: Type G90 or G120, L170 Ø120 mm frosted, 1000 - 1500 lm, 2700 K, CRI >90. Light source not included

Ø60 – EU/US: E27/E26, max. 60W Incandescent, 18W SBCFL or 18W SBLED. Recommended light source: Type G90 or G120, L170 Ø120 mm frosted, 800 - 1000 lm, 2700 K, CRI >90. Light source not included

Ø40 – EU/US: E27/E26, max. 40W Incandescent, 13W SBCFL or 13W SBLED. Recommended light source: Type G90, L130 Ø90 mm frosted, 600 - 800 lm, 2700 K, CRI >90. Light source not included

Ø28 – EU/US: E27/E26, max. 40W Incandescent, 13W SBCFL or 13W SBLED. Recommended light source: Type G90, L130 Ø90 mm frosted, 400 - 600 lm, 2700 K, CRI >90. Light source not included

Versions: EU, UK, US, AUD/NZL, EURASIA, CHN

The Rime Pendant Lamp brings an elegant perspective to the glass light through its mouthblown semi-transparent glass.



RIME PENDANT LAMP

by TAF Studio

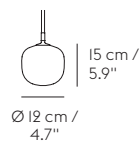
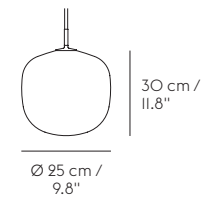
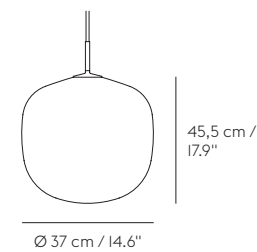
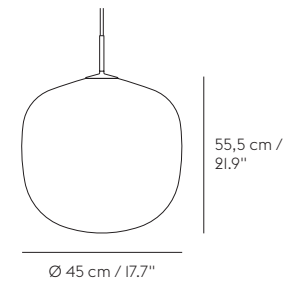

Black

White

Orange

Grey

MATERIAL

Mouthblown glass shade, aluminum, powder coated top-piece and pendant tube, PVC cord

LIGHT SOURCE

Ø45 – EU/US: E27/E26, max. 60W Incandescent or 18W SBLED
Recommended light source: Type A60 or A67, L110 Ø60 mm frosted, 750-1500 lm, 2700 K, CRI >90. Light source not included

Ø37 – EU/US: E27/E26, max. 60W Incandescent or 18W SBLED
Recommended light source: Type A60, L110 Ø60 mm frosted, 750-1500 lm, 2700 K, CRI >90. Light source not included

Ø25 – EU/US: E14/E12, max. 40W Incandescent or 10W SBLED
Recommended light source: Type P45, L85 Ø45 mm frosted, 400-800 lm, 2700 K, CRI >90. Light source not included

Ø12 – EU: G9, max. 25W. Included light source: 3W frosted LED, 200 lm, 2700K, CRI >90, dimmable

Versions: EU, UK, US (except Ø12), AUD/NZL, CHN
Please note that the availability of this product or specific variants of it may vary across regions.

RIME WALL LAMP

by TAF Studio

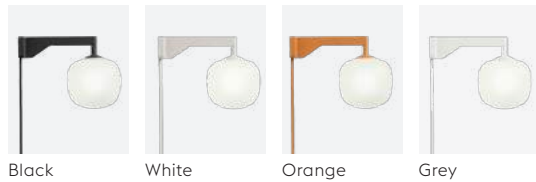

Black

White

Orange

Grey

23,9 cm / 9,1"

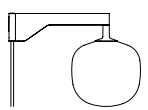

16,2 cm / 6,4"

Ø 12 cm / 4,7"

MATERIAL

Shade in mouthblown, sandblasted glass. Arm in pressure die-casted and powder-coated aluminum. Wall bracket in chrome-plated steel. Cord in PVC.

LIGHT SOURCE

EU: G9, max. 25W. Included light source: 3W frosted LED, 190 lm, 2700K, CRI 90, dimmable

Variants: EU, UK

The Rime Wall Lamp is inspired by the shape of acorns for its subtle lines while hinting towards the shaded expression of ice and rime for the glass of the design, allowing for light to shine slightly through with a refined touch.



POST FLOOR LAMP

by Earnest Studio

The Post Floor Lamp is an innovative modular lighting design with an archetypal appearance, graphic lines and forward-thinking functionalities.



MATERIAL

Powder coated steel base, PVC cord, powder coated magnesium, acrylic opal diffuser, silicone cord, magnet with powder coated plastic

LIGHT SOURCE

Integrated non-replaceable LED, max. 13W, 660 lm (330 lm/light unit), 2700 K, CRI 90, dimmable

Versions: EU, UK, US, EURASIA

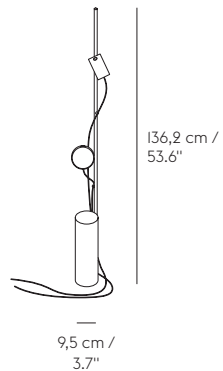

POST WALL LAMP

by Earnest Studio

Exploring the utmost flexibility of a magnetic joint, the Post Wall Lamp can be positioned, dimmed and turned according to your exact needs.



MATERIAL

Powder coated magnesium, acrylic opal diffuser, silicone cord, magnet with powder coated plastic

LIGHT SOURCE

Integrated non-replaceable LED, max. 6.7W, 330 lm, 2700 K, CRI 90, dimmable

Versions: EU, UK, US, EURASIA

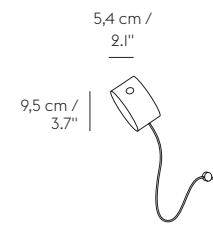

LINEAR PENDANT LAMP

by Thomas Bentzen



Black

Grey

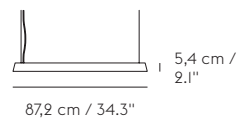
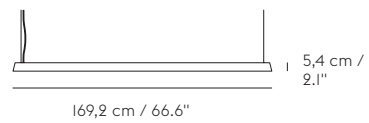

MATERIAL

Lamphead in pressure-die casted and extruded, powder coated aluminum. Diffuser in polycarbonate. PVC cord.

LIGHT SOURCE

169,2 cm EU: Integrated non-replaceable LED, max. 37.7W, 1880 lm, 3000 K, CRI 90, dimmable

87,2 cm EU: Integrated non-replaceable LED, max. 20.3W, 1060 lm, 3000 K, CRI 90, dimmable

Variants: EU, UK

Designed to create smaller atmospheres within larger spaces, the Linear Pendant Lamp provides dimmable overhead lighting while complementing the atmosphere through its elegant profile.



LINEAR TABLE LAMP

by Thomas Bentzen

The Linear Table Lamp hints towards the archetypal library lamp through its familiar form, featuring a dimmable LED and a USB-C plug for charging electronic devices.

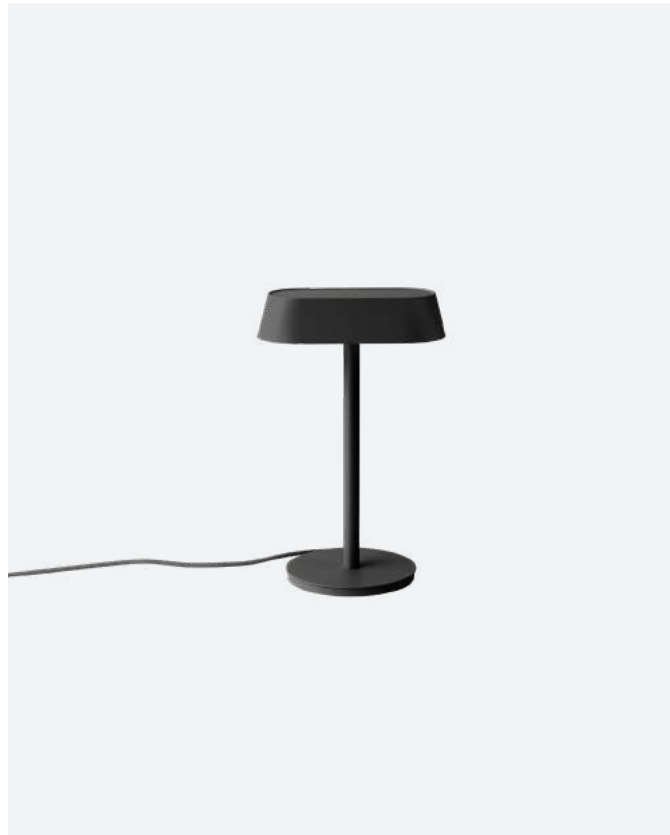

Black



Grey



36,5 cm /
14,4"

23,2 cm /
9,1"

MATERIAL

Lamphead in powder coated, pressure die-casted aluminum. Stem in powder coated steel. Polycarbonate diffuser and PVC cord.

LIGHT SOURCE

Integrated non-replaceable LED, max. 6.25W, 242 lm, 3000 K, CRI 90, dimmable, built-in 18W USB-C charger

Variants: EU, UK



Embodying the values of Scandinavian design, the Ambit Pendant Lamp is as timeless as it is contemporary, enhancing the light emitted in any room.



AMBIT PENDANT LAMP

by TAF Studio

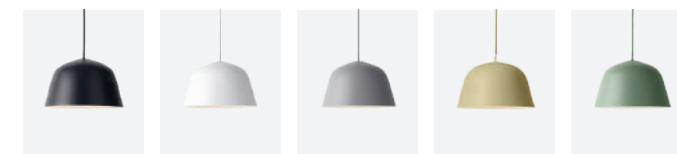
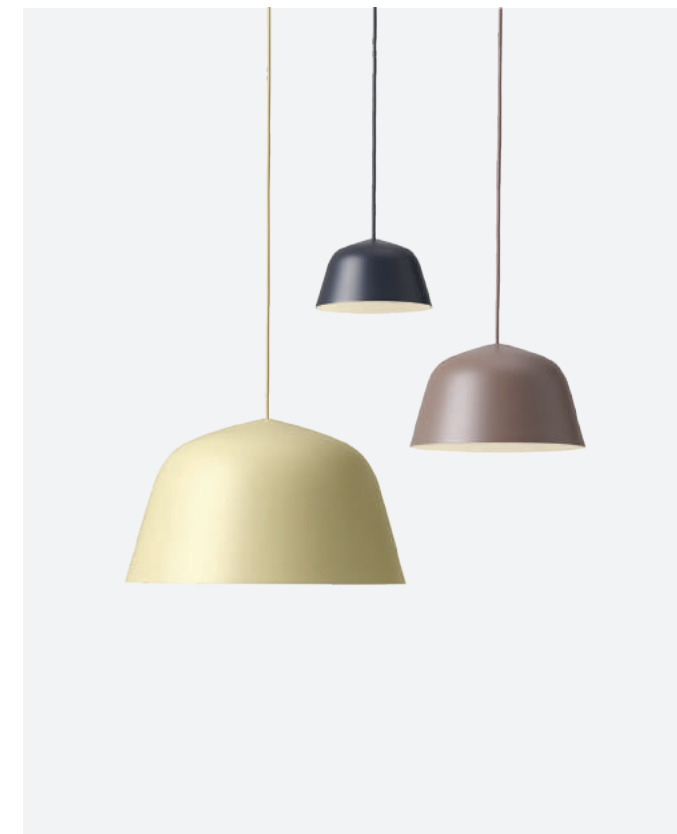

Black

White

Grey

Beige-Green

Dusty Green

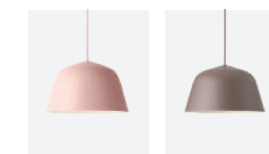

Rose

Taupe

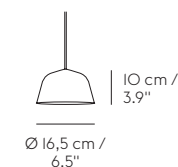
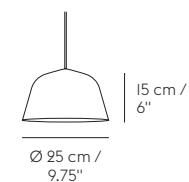
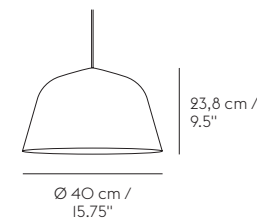

MATERIAL

Handspun and handpainted aluminum shade, PVC cord

LIGHT SOURCE

Ø40 – EU/US: E27/E26, max. 60W Incandescent, 13W SBCFL or 11W SBLED. Recommended light source: Type A60, L110 Ø60 mm frosted, 600-1000 lm, 2700 K, CRI >80. Light source not included

Ø25 – EU/US: E14/E12, max. 60W Incandescent, 13W SBCFL or 11W SBLED. Recommended light source: Type G45 or P45, L85 Ø45 mm frosted, 400-600 lm, 2700 K, CRI >80. Light source not included

Ø16,5 – EU & US: GX53, max. 12W LED. Included light source: 5,5W frosted LED, 330 lm, 2700K, CRI >90, dimmable

Versions: EU, UK, US, AUD/NZL (except Ø16,5), CHN
Please note that the availability of this product or specific variants of it may vary across regions.

AMBIT RAIL LAMP

by TAF Studio

The Ambit Rail Lamp is characterized by its simple lines and elegant shapes, bringing a refined light to any space.



Black White Grey

MATERIAL

Cast and extruded aluminum, handspun aluminum, PVC cord, steel wires

LIGHT SOURCE

EU/US: E14/E12, 3x max. 60W Incandescent, 3x 13W SBCFL or 3x 11W SBLED. Recommended light source: Type G45 or P45, L85 Ø45 mm frosted, 400-600 lm, 2700 K, CRI >80. Light source not included

Versions: EU, UK, US, AUD/NZL, CHN

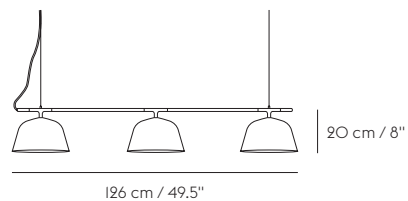

AMBIT WALL LAMP

by TAF Studio

The Ambit Wall Lamp is designed with a quiet, modern expression and subtle details. Through its rotating arm and head, the lamp brings refined light to any room.

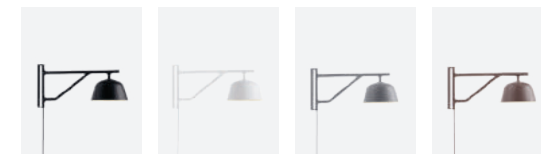

Black White Grey Taupe

MATERIAL

Handspun aluminum, pressure die-casted aluminum, PVC cord

LIGHT SOURCE

EU & US: GX53, max. 12W SBLED. Included light source (for EU version only): 5,5W frosted LED, 330 lm, 2700K, CRI >90, dimmable

Versions: EU, UK, US

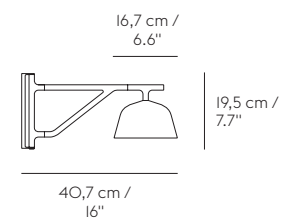

GRAIN PENDANT LAMP

by Jens Fager

The Grain Pendant Lamp is made from a bamboo fiber composite, lending the design an elegant, matte surface.

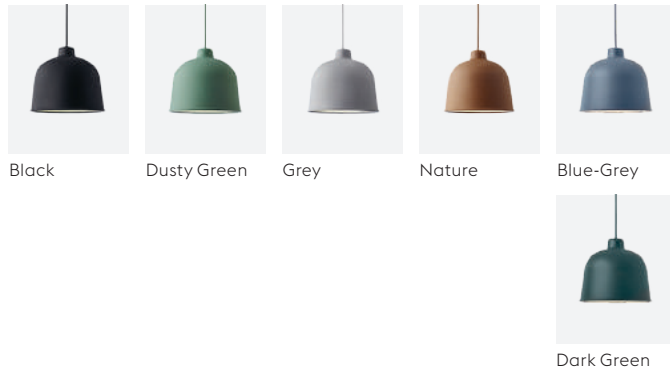

MATERIAL
Mixture of bamboo fibers and plastic, PVC cord

LIGHT SOURCE
EU & US: G9, max. 5W SBLLED. Included light source: 3W LED, 260 lm, 3000K, CRI >90, dimmable

Versions: EU, UK, US, AUD/NZL, CHN
Please note that the availability of this product or specific variants of it may vary across regions.

BEAM TABLE LAMP

by Tom Chung

Beam is a versatile table lamp with a modern expression and intuitive user-friendliness through the turn of a playful dial with light shone from both ends.

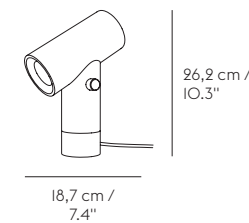

MATERIAL
Extruded aluminum, PVC cord

LIGHT SOURCE
Integrated non-replaceable LEDs, max. 10.5W, 425 lm, 2700 K, CRI >90, dimmable

Versions: EU, UK, US, EURASIA

TIP FLOOR LAMP

by Jens Fager



Black White Grey

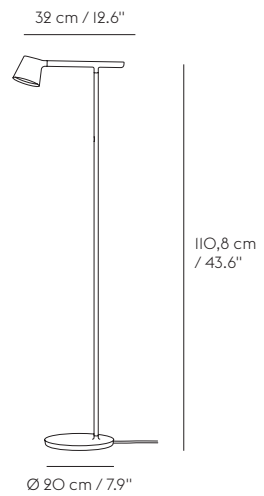

MATERIAL
Pressure die-casted aluminum, PVC cord

LIGHT SOURCE
Integrated non-replaceable LED, max. 10,9W, 330 lm, 2700 K, CRI 90, dimmable

Versions: EU, UK

The Tip Floor Lamp features a dimmable light source for both ambient and direct lighting. Designed in a height that allows for the user to dim and turn the lampshade and arm whilst seated.



TIP TABLE LAMP

by Jens Fager

Offering direct as well as ambient light, the Tip Table Lamp's adjustable head and arm feature an opal diffuser and dimmer function that effortlessly alters the volume of light.



Black White Grey Copper Brown Olive

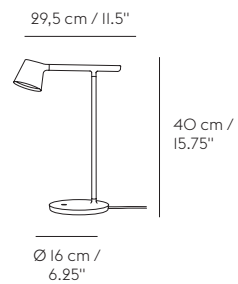

MATERIAL
Pressure die-casted aluminum, PVC cord

LIGHT SOURCE
Integrated non-replaceable LED, max. 8W, 200 lm, 3000 K, CRI 90, dimmable

Versions: EU, UK, US, AUD/NZL
Please note that the availability of this product or specific variants of it may vary across regions.

TIP WALL LAMP

by Jens Fager

The Tip Wall Lamp offers direct as well as ambient lighting, featuring an adjustable head with opal diffuser and dimmer function, allowing you to alter the volume of light as you'd like.



Black White Grey Copper Brown

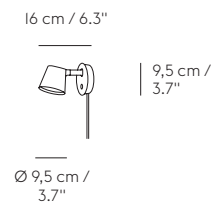

MATERIAL
Pressure die-casted aluminum, PVC cord

LIGHT SOURCE
Integrated non-replaceable LED, max. 8W, 220 lm, 2700 K, CRI 90, dimmable

Versions: EU, UK, US, AUD/NZL
Please note that the availability of this product or specific variants of it may vary across regions.

With its naked LED bulb and playfully modern silicone rubber material, the E27 Pendant Lamp is a simple yet characterful addition to any space.

E27 PENDANT LAMP

by Mattias Ståhlbom

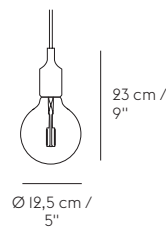
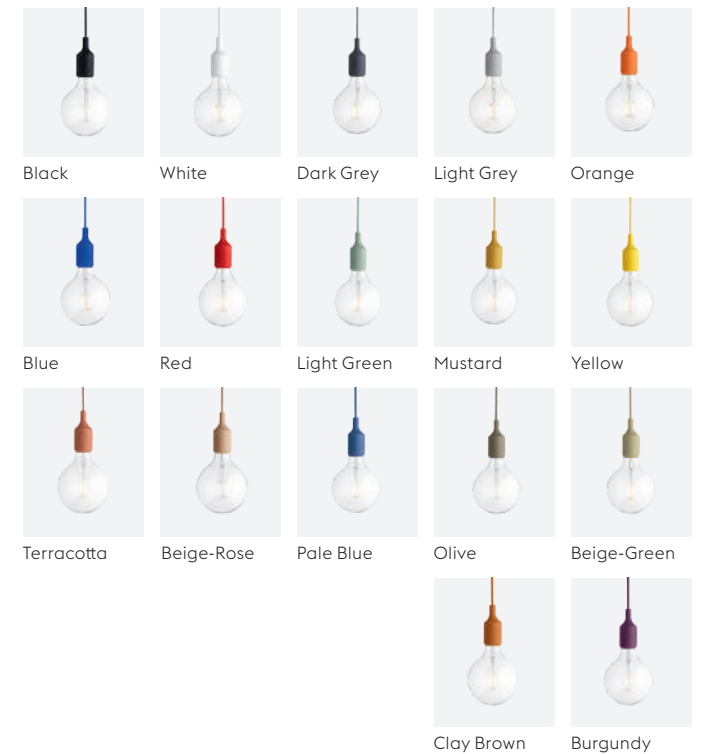

MATERIAL
Silicone rubber

LIGHT SOURCE
EU/US: E27/E26, max. 40W Incandescent or 6W SBLED. Included light source: 2W LED, 190 lm, 2500K, CRI >90, dimmable

Versions: EU, UK, US, AUD/NZL, EURASIA, CHN

The soft, silicone rubber shade of Unfold makes for a unique and playful take on the timeless industrial lamp. With its modern expression and soft materiality in a wide variety of colors, the Unfold Pendant Lamp adds a vibrant touch.



UNFOLD PENDANT LAMP

by Form Us With Love

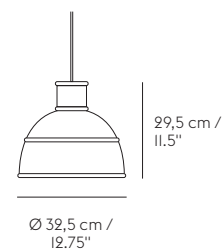
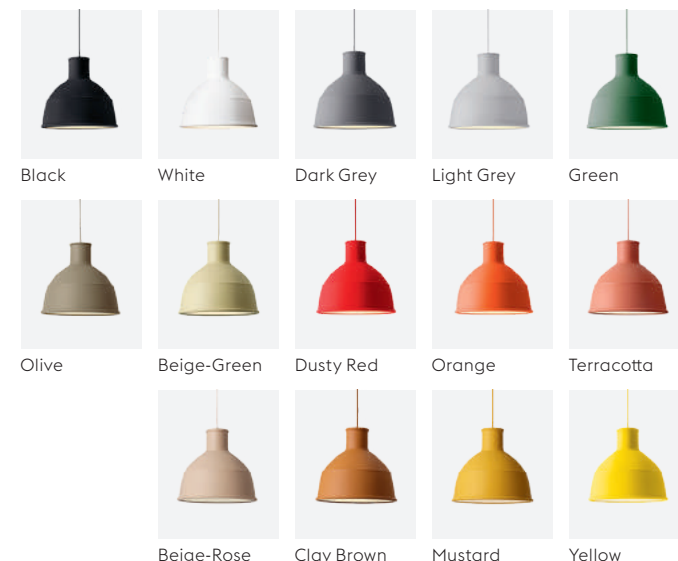
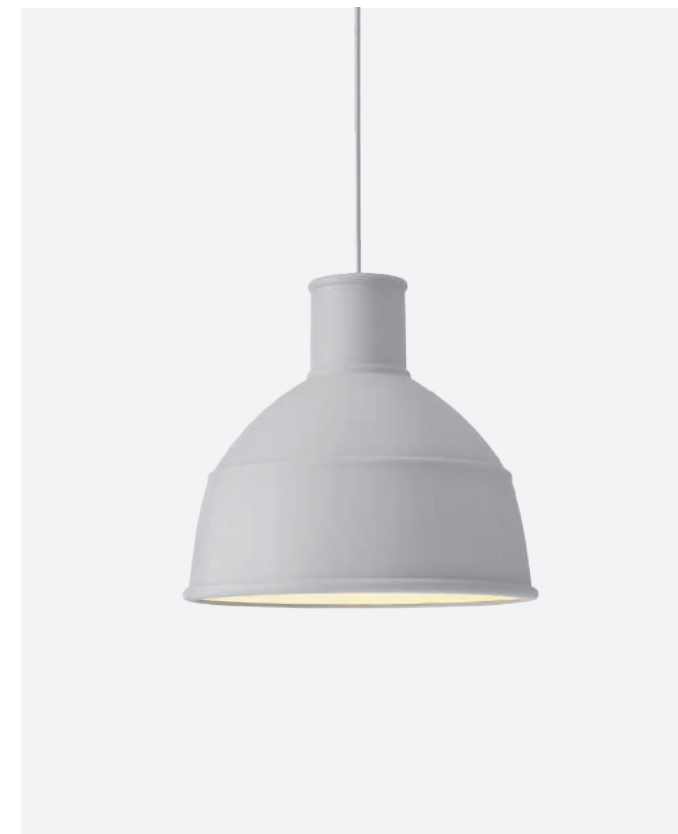

MATERIAL
Silicone rubber, PC plastic diffuser

LIGHT SOURCE
EU/US: E27/E26, max. 60W Incandescent or 20W SBCFL
Recommended light source: Type A60, L110 Ø60 mm frosted,
600-1000 lm, 2700 K, CRI >80. Light source not included

Versions: EU, UK, US, AUD/NZL, EURASIA, CHN

UNDER THE BELL PENDANT LAMP

by Iskos-Berlin

Designed in a material that uses up to 80% recycled plastic, the Under The Bell Pendant Lamp not only brings a tactile and modern expression to any space but also enhances the acoustics of a room.

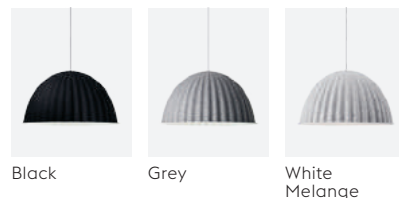

Black

Grey

White
Melange

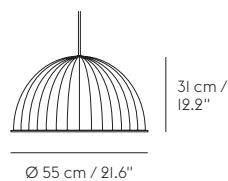
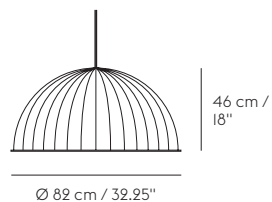

MATERIAL
Recycled plastic, PVC cord

LIGHT SOURCE
Ø82 & Ø55 – EU/US: E27/E26, max. 30W SBCFL or 18W SBLED / max. 60W Incandescent or 30W SBCFL. Recommended light source: Type A60 or G90 or G125, L175 Ø125 mm frosted, 1000 - 1500 lm, 2700 K, CRI >80. Light source not included

Versions: EU, UK, US, AUD/NZL, EURASIA, CHN



Inspired by a resting drop of water, the Fluid Pendant Lamp shows how soft light can diffuse throughout a space for a cosy atmosphere.



FLUID PENDANT LAMP

by Claesson Koivisto Rune

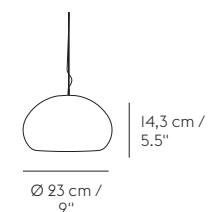
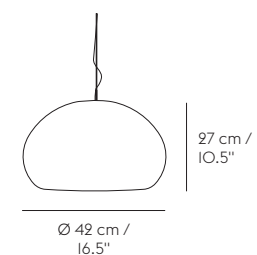
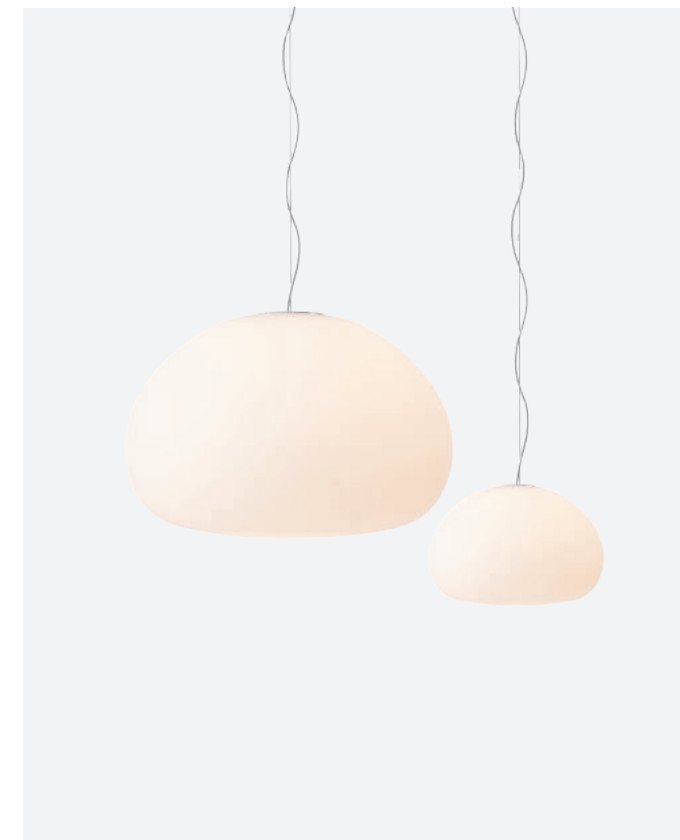

MATERIAL
Silk matt opal glass, PVC cord, metal wire

LIGHT SOURCE
Ø42 – EU/US: E27/E26, max. 60W Incandescent, 13W SBCFL or 18W SBLED / 60W Incandescent or 13W SBCFL. Recommended light source: Type A, L115 Ø70 mm frosted, 600 - 1000 lm, 2700 or 3000 K, CRI >90. Light source not included

Ø23 – EU & US: G9, max. 40W. Included light source: 3W LED, 260 lm, 3000K, CRI >90, dimmable

Versions: EU, UK, US, AUD/NZL, CHN

LEAF FLOOR LAMP

by Broberg & Ridderstråle

With its elegant body and the organic shape of its head, the Leaf Floor Lamp brings a gentle and dimmable light to any space.

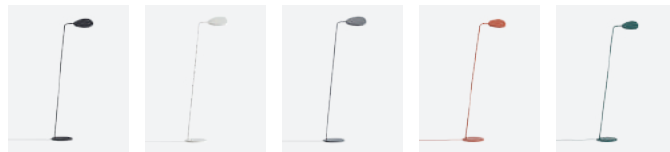

Black White Grey Copper Brown Dark Green

15,5 x 18,5 cm /
6" x 7.25"

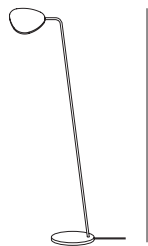

22 cm /
8.75"

MATERIAL

Pressure die-casted aluminum, PVC cord

LIGHT SOURCE

Integrated non-replaceable LEDs, max. 8W, 370 lm, 3000 K, CRI 90, dimmable

Versions: EU, UK, US, AUD/NZL

Please note that the availability of this product or specific variants of it may vary across regions.

LEAF TABLE LAMP

by Broberg & Ridderstråle

Inspired by the leaves of a tree and featuring a dimmable LED light, the Leaf Table Lamp is an easy match with your desk, bedside or any table space.

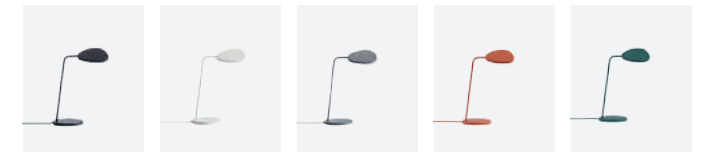

Black White Grey Copper Brown Dark Green

15,5 x 18,5 cm /
6" x 7.25"



18 cm /
7"

MATERIAL

Pressure die-casted aluminum, PVC cord

LIGHT SOURCE

Integrated non-replaceable LEDs, max. 8W, 370 lm, 3000 K, CRI 90, dimmable

Versions: EU, UK, US, AUD/NZL

Please note that the availability of this product or specific variants of it may vary across regions.

PULL FLOOR LAMP

by Whatswhat



Oak/White Grey/White

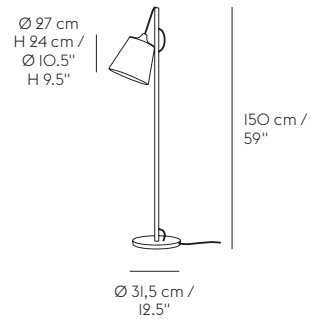

MATERIAL

Oiled oak wood or grey lacquered oak wood, 100% linen covered plastic shade, textile cord

LIGHT SOURCE

EU/US: E27/E26, max. 60W Incandescent. Recommended light source: Type A60, L110 Ø60 mm frosted, 600 - 1000 lm, 2700 K, CRI >90. Light source not included

Versions: EU, UK, US, AUD/NZL
Light source must be dimmable.

Fusing the ideas of Scandinavian design with a playful approach, the Pull Floor Lamp combines the warmth of oak with an adjustable shade for a cosy light.



FOCUS TABLE LAMP

by Andreas Bergsaker

With a protruding base that is perfect for small items, the Focus Table Lamp fits seamlessly on a windowsill or shelf in need for a bit of light.



COSY IN GREY TABLE LAMP

by Harri Koskinen

With its modern shape in mouth-blown glass, the Cosy In Grey Table Lamp provides gentle lighting through its dimmable naked bulb, encased in smoked grey glass.



50

Muto Lighting

51

Muto Lighting

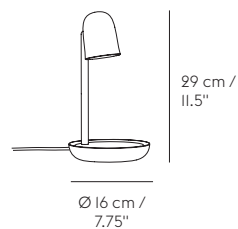

MATERIAL
Turned ash wood, PVC cord

LIGHT SOURCE
EU: GU10, max. 3W SBLED
Recommended light source: Type MR 16, L70 Ø50 mm frosted, 150-300 lm, 2700 K, CRI >80. Light source included

Versions: EU, UK

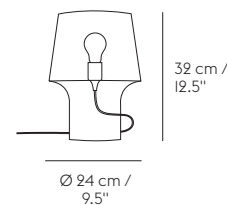

MATERIAL
Mouth-blown soda lime glass, textile cord

LIGHT SOURCE
EU: E27, max. 60W Incandescent or 6W SBLED. Recommended light source: Type A60, L110 Ø70 mm clear spiral filament, 250-500 lm, 2500 K, CRI >90. Light source not included

Versions: EU, UK
Light source must be dimmable.

CONTROL TABLE LAMP

by TAF Studio



Black

White

Grey

Copper Brown

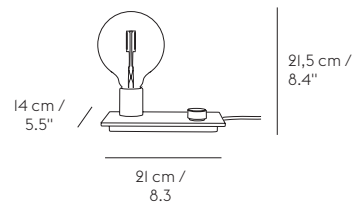

MATERIAL
Casted aluminum, PVC cord

LIGHT SOURCE
EU/US: E27/E26, max. 40W Incandescent or 6W SBLED. Included light source: 2W LED, 190 lm, 2500K, CRI >90, dimmable

Versions: EU, UK, US, AUD/NZL
Light source must be dimmable.

A unique and playful lamp with references to hi-fi and industrial design, the Control Table Lamp has a friendly dimmer that hints towards volume controls.





Tip Wall Lamp
by Jens Fager

Availability

Please note that all variants are subject to stock availability and certification across regions. Please check availability with your local retailer.

Prices

Please find recommended retail prices on ipaper.ipapercms.dk/Muuto/muuto-lighting-catalog

Downloads

Find more product information, product fact sheets, assembly instructions, lifestyle images, packshots and much more on our download site

download.muuto.com

Join Us

Sign up to our newsletter or follow us on social media to stay in the loop on new product releases, case stories and events.

muuto.com/newsletter
[instagram.com/muutodesign](https://www.instagram.com/muutodesign)
[pinterest.com/muuto](https://www.pinterest.com/muuto)
[facebook.com/muuto](https://www.facebook.com/muuto)
twitter.com/muutodesign
[linkedin.com/company/muuto](https://www.linkedin.com/company/muuto)

Artworks by

Amalie Jakobsen /
 Gether Contemporary
 Anders von Greffelstein
 Anne Marie Stahl
 Anne Nowak
 Elsa Binder
 Else-Rikke Bruun
 Jeba Arkitekter
 Josephine Andredottir &
 Emilie Bobek
 Kristel Laurits
 Kristine Mandsbjerg
 Leila Guinefollau
 Linda Weimann
 Lis Andersen
 Malene Bach
 Mette Sandfær
 Nanna Gabriella
 Noa Noon Gammelgaard
 Sara Martinsen
 Sara Saur
 Sigrid Soomus
 Stine Leth
 The Ode To

Muuto Head Office
 Østergade 36-38
 DK-1100 Copenhagen,
 Denmark

For more information
 visit muuto.com

Prices

All prices are recommended retail prices from the Q1 2021 price list and are subject to change.



**STRAND
PENDANT LAMP**
Closed Ø 80

€ 795 / £ 715 / DKK 5.995 /
SEK 8.049 / NOK 8.049 /
USD 995 / CAD 1.295



**STRAND
PENDANT LAMP**
Closed Ø 60

€ 679 / £ 615 / DKK 4.995 /
SEK 6.749 / NOK 6.749 /
USD 849 / CAD 1.149

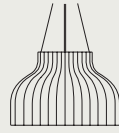

**STRAND
PENDANT LAMP**
Open Ø 60

€ 595 / £ 535 / DKK 4.495 /
SEK 6.049 / NOK 6.049 /
USD 745 / CAD 965



**STRAND
PENDANT LAMP**
Open Ø 40

€ 395 / £ 355 / DKK 2.995 /
SEK 4.049 / NOK 4.049 /
USD 495 / CAD 645



**STRAND
PENDANT LAMP**
Open Ø 28

€ 269 / £ 245 / DKK 1.995 /
SEK 2.695 / NOK 2.695 /
USD 335 / CAD 439



**FLUID
PENDANT LAMP**
Ø 42

€ 299 / £ 269 / DKK 2.295 /
SEK 3.095 / NOK 3.095 /
USD 449 / CAD 595



**FLUID
PENDANT LAMP**
Ø 23

€ 169 / £ 155 / DKK 1.195 /
SEK 1.649 / NOK 1.649 /
USD 269 / USD 349



**UNDER THE BELL
PENDANT LAMP**
Ø 82

€ 699 / £ 629 / DKK 4.495 /
SEK 5.995 / NOK 6.049 /
USD 875 / CAD 1.149



**UNDER THE BELL
PENDANT LAMP**
Ø 55

€ 499 / £ 449 / DKK 3.495 /
SEK 4.695 / NOK 4.695 /
USD 735 / CAD 995



**E27
PENDANT LAMP**
Ø 12,5

€ 69 / £ 65 / DKK 499 /
SEK 675 / NOK 675 /
USD 105 / CAD 139



**RIME
PENDANT LAMP**
Ø 45

€ 469 / £ 425 / DKK 3.495 /
SEK 4.695 / NOK 4.695 /
USD 585 / CAD 765



**RIME
PENDANT LAMP**
Ø 37

€ 399 / £ 349 / DKK 2.995 /
SEK 3.995 / NOK 4.049 /
USD 499 / CAD 649



**RIME
PENDANT LAMP**
Ø 25

€ 349 / £ 315 / DKK 2.495 /
SEK 3.349 / NOK 3.349 /
USD 435 / CAD 565



**RIME
PENDANT LAMP**
Ø 12

€ 199 / £ 179 / DKK 1.495 /
SEK 1.995 / NOK 2.049 /
USD 249 / CAD 325



**RIME
WALL LAMP**

€ 335 / £ 305 / DKK 2.495 /
SEK 3.349 / NOK 3.349 /
USD 509 / CAD 659



**GRAIN
PENDANT LAMP**
Ø 21

€ 135 / £ 125 / DKK 995 /
SEK 1.349 / NOK 1.349 /
USD 209 / CAD 265



**UNFOLD
PENDANT LAMP**
Ø 32,5

€ 175 / £ 159 / DKK 1.249 /
SEK 1.695 / NOK 1.695 /
USD 269 / CAD 349



**STUDIO
PENDANT LAMP**
Ø 39

€ 349 / £ 315 / DKK 2.495 /
SEK 3.349 / NOK 3.349 /
USD 435 / CAD 565



**POST
WALL LAMP**
Ø 9,5

€ 249 / £ 225 / DKK 1.795 /
SEK 2.449 / NOK 2.449 /
USD 375 / CAD 485



**POST
FLOOR LAMP**
H 136,2

€ 599 / £ 539 / DKK 4.495 /
SEK 6.049 / NOK 6.049 /
USD 925 / CAD 1.195



**LINEAR
PENDANT LAMP**
L 169,2 cm

€ 710 / £ 639 / DKK 5.295 /
SEK 7.149 / NOK 6.695

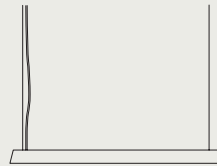

**LINEAR
PENDANT LAMP**
L 87,2 cm

€ 535 / £ 485 / DKK 3.995 /
SEK 5.395 / NOK 5.049



**LINEAR
TABLE LAMP**
H 36,5 cm

€ 375 / £ 339 / DKK 2.795 /
SEK 3.795 / NOK 3.549 /
USD 569 / CAD 739



**TIP
FLOOR LAMP**
H 110,8

€ 395 / £ 355 / DKK 2.995 /
SEK 4.049 / NOK 4.049 /
USD 495 / CAD 645



**TIP
TABLE LAMP**
H 40

€ 269 / £ 245 / DKK 1.995 /
SEK 2.695 / NOK 2.695 /
USD 399 / CAD 535



**TIP
WALL LAMP**
Ø 9,5

€ 195 / £ 175 / DKK 1.495 /
SEK 2.049 / NOK 2.049 /
USD 299 / CAD 389



**LEAF
FLOOR LAMP**
H 118

€ 349 / £ 315 / DKK 2.495 /
SEK 3.349 / NOK 3.349 /
USD 535 / CAD 689



**LEAF
TABLE LAMP**
H 41,5

€ 249 / £ 225 / DKK 1.795 /
SEK 2.449 / NOK 2.449 /
USD 385 / CAD 495



**AMBIT
PENDANT LAMP**
Ø 40

€ 375 / £ 339 / DKK 2.795 /
SEK 3.795 / NOK 3.795 /
USD 599 / CAD 779



**AMBIT
PENDANT LAMP**
Ø 25

€ 199 / £ 179 / DKK 1.495 /
SEK 2.049 / NOK 2.049 /
USD 299 / CAD 395



**AMBIT
PENDANT LAMP**
Ø 16,5

€ 149 / £ 135 / DKK 1.095 /
SEK 1.495 / NOK 1.495 /
USD 229 / CAD 299

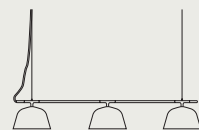

**AMBIT
RAIL LAMP**
L 126

€ 749 / £ 675 / DKK 5.495 /
SEK 7.395 / NOK 7.395 /
USD 1.149 / USD 1.495



**AMBIT
WALL LAMP**
L 37

€ 349 / £ 315 / DKK 2.495 /
SEK 3.349 / NOK 3.349 /
USD 535 / CAD 695

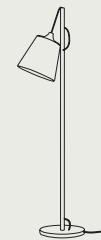

**PULL
FLOOR LAMP**
H 150

€ 469 / £ 425 / DKK 3.495 /
SEK 4.695 / NOK 4.695 /
USD 569 / CAD 739



**BEAM
TABLE LAMP**
H 26,2

€ 199 / £ 179 / DKK 1.495 /
SEK 1.995 / NOK 2.049 /
USD 299 / CAD 395



**CONTROL
TABLE LAMP**
H 21,5

€ 149 / £ 135 / DKK 995 /
SEK 1.295 / NOK 1.349 /
USD 229 / CAD 299



**COSY IN GREY
TABLE LAMP**
H 32

€ 229 / £ 209 / DKK 1.695 /
SEK 2.295 / NOK 2.295 /
USD 285 / CAD 375



**FOCUS
TABLE LAMP**
H 29

€ 159 / £ 145 / DKK 1.150 /
SEK 1.549 / NOK 1.549 /
USD 199 / CAD 259

By the leading
contemporary designers:

Andreas Bergsaker
Benjamin Hubert
Broberg & Ridderstråle
Claesson Koivisto Rune
Earnest Studio
Form Us With Love
Harri Koskinen
Iskos-Berlin
Jens Fager
Mattias Ståhlbom
TAF Studio
Thomas Bentzen
Tom Chung
Whatswhat

Styling:
Pernille Vest

Photography:
Petra Bindel / Mikkel Tjelleesen

Printing:
Narayana Press

Subject to printer's errors