

IN SITU MODULAR SOFA 2-Seater Configuration 3

— Anderssen & Voll

1

Place all components on a flat, clean and soft surface to avoid scratches and to get an overview of all parts that are needed to assemble your sofa.

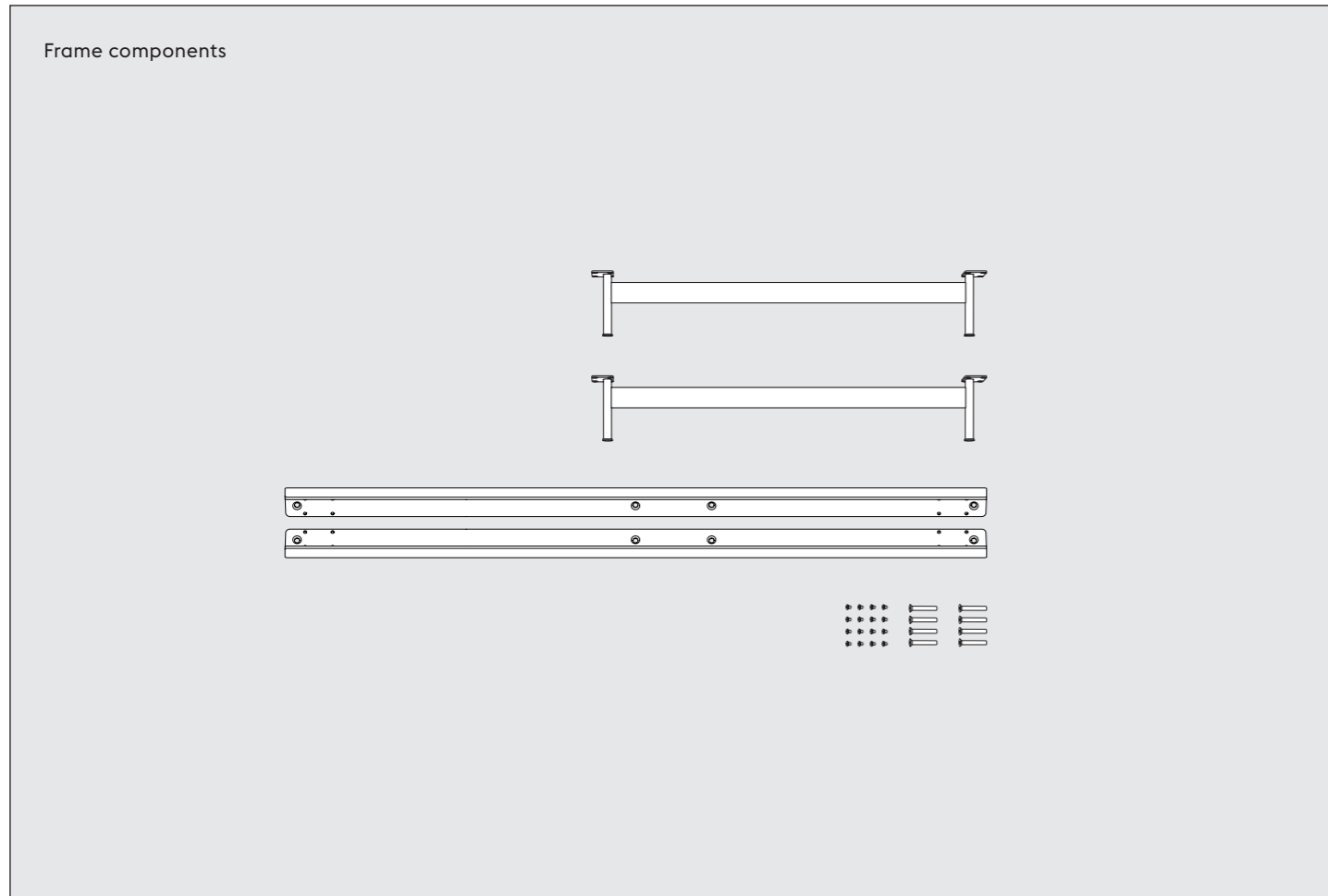
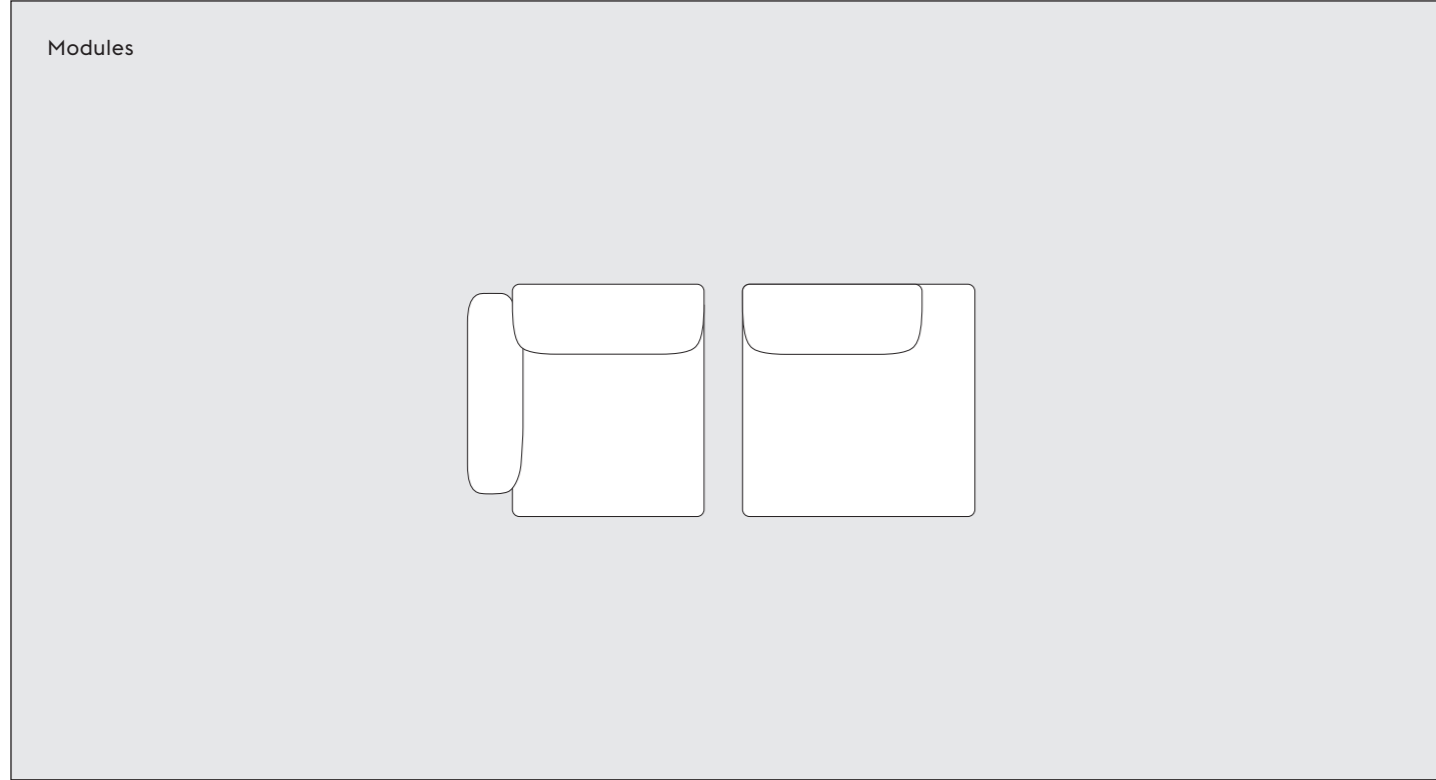

2

Make sure you have received all components needed.

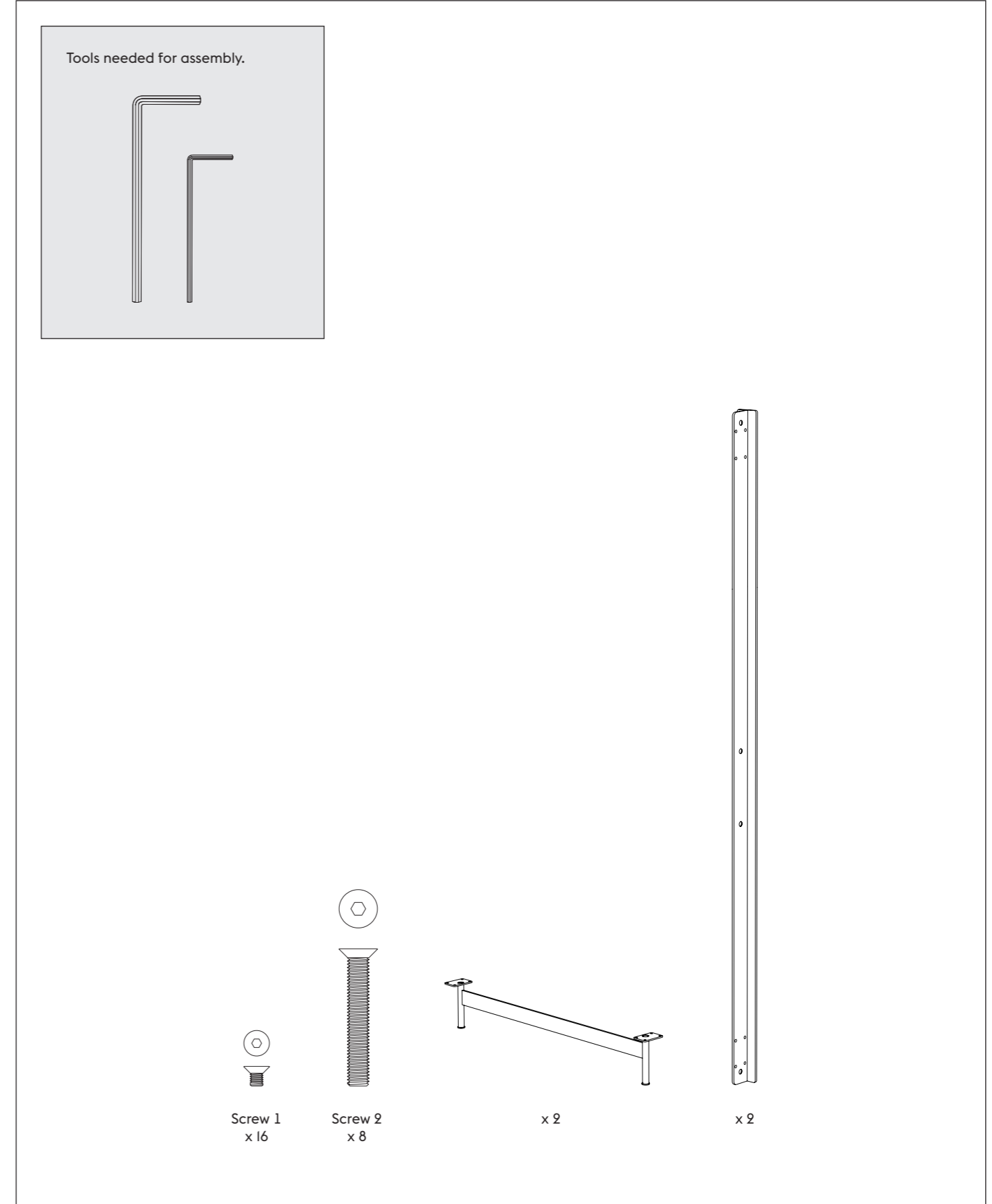

3

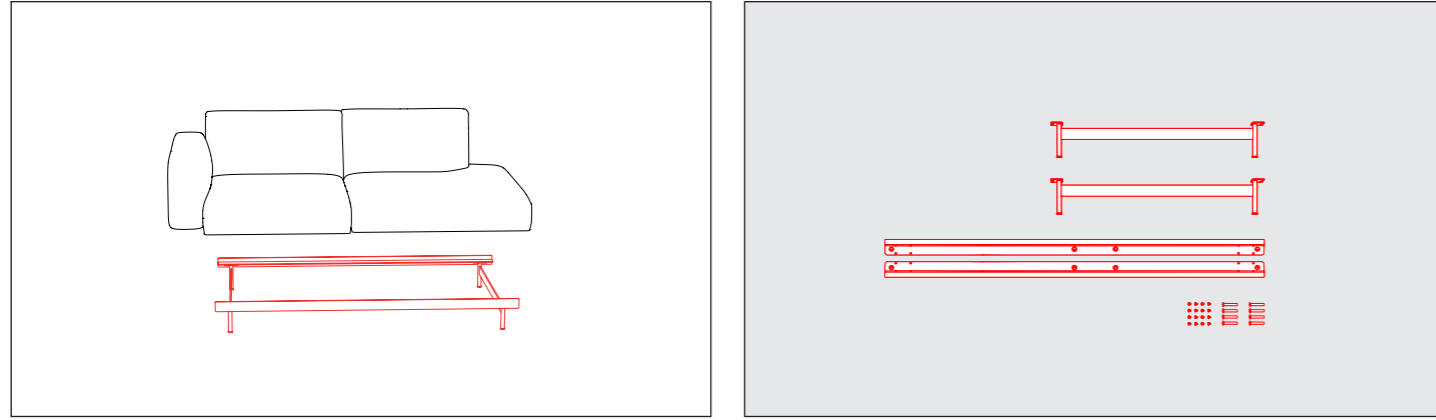

Assembling the straight section:

Place needed components on the floor and fasten legs to bars with screws.

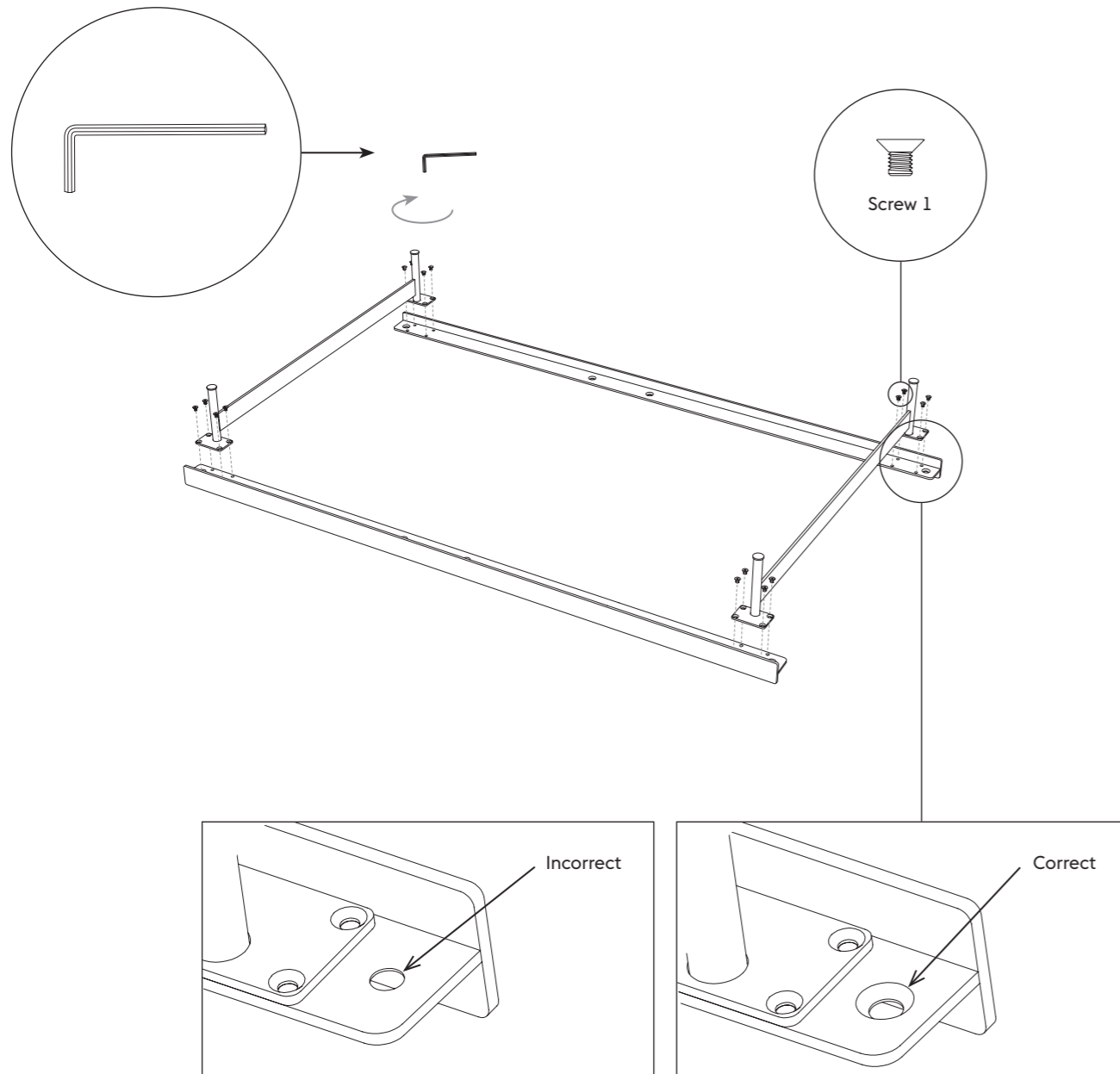

4

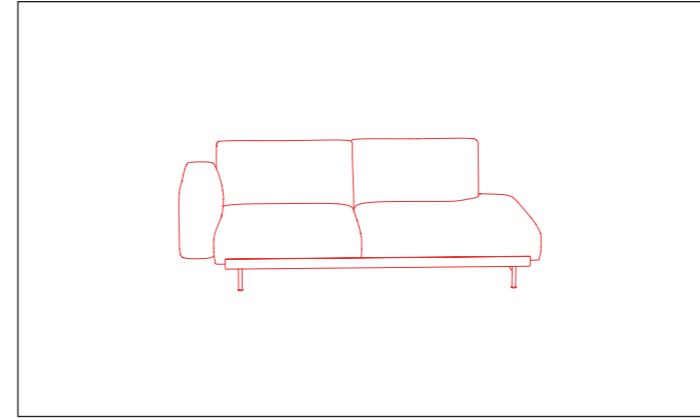

Starting from one side/end of the frame section, attach the individual modules loosely without leaving any gap in between.

When all modules are attached, secure the modules by tightening the screws.

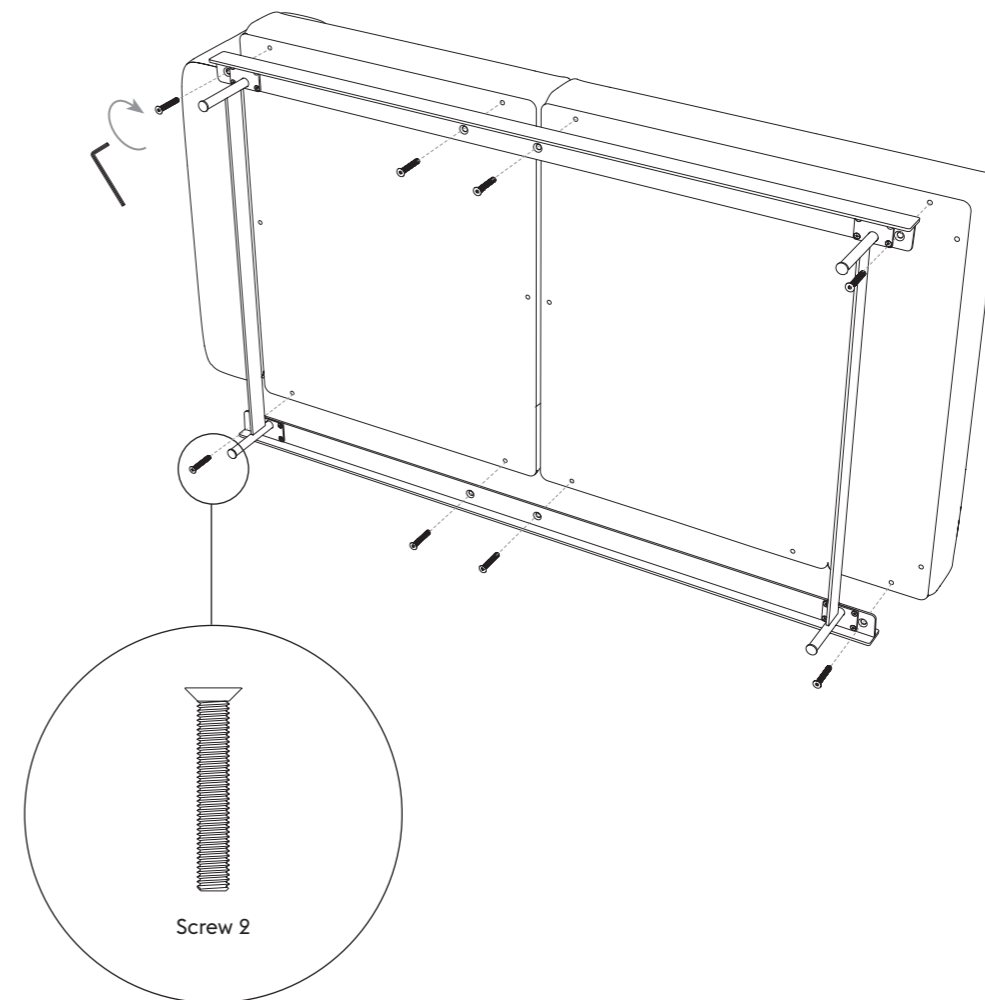

CLEANING — RENGØRING — SÄUBERN — NETTOYAGE — LIMPIEZA

- EN To remove stains from a textile-upholstered sofa, use foam from a mild mixture of water and detergent. A leather-upholstered sofa should be treated 2-3 times a year. Keep leather products away from direct sunlight and dry air.
- DK Brug skummet fra en mild blanding af vand og opvaskemiddel til at fjerne pletter på en tekstil polstret sofa. Sofaer med læder polster skal behandles 2-3 gange om året. Hold læder produkter fra direkte sollys og tør luft.
- DE Zum Entfernen von Flecken auf gepolsterten Sofas verwenden Sie den Schaum aus einer Wasser-Spülmittel-Mischung. Sofas mit Lederpolstern sollten 2-3 Mal im Jahr behandelt werden. Die Lederprodukte von direkter Sonneneinstrahlung und trockener Luft fernhalten.
- FR Pour retirer les tâches du textile sur les canapés, utilisez de la mousse depuis un mélange d'eau douce et du détergent. Le cuir des canapés devrait être traité 2 à 3 fois par an. Veillez à ne pas exposer directement les produits en cuir à la lumière et à l'air frais.
- ES Para eliminar las manchas del tapizado textil de los sofás, utilice una solución de agua jabonosa neutra. Trate el tapizado de los sofás de cuero entre 2 y 3 veces al año con el set de cuidado para pieles incluido. No exponga los productos de cuero a la luz solar directa ni al aire seco.

