

- INSTRUCTION MANUAL -

# CPH DEUX 210

L140/200 X W75 X H73 CM

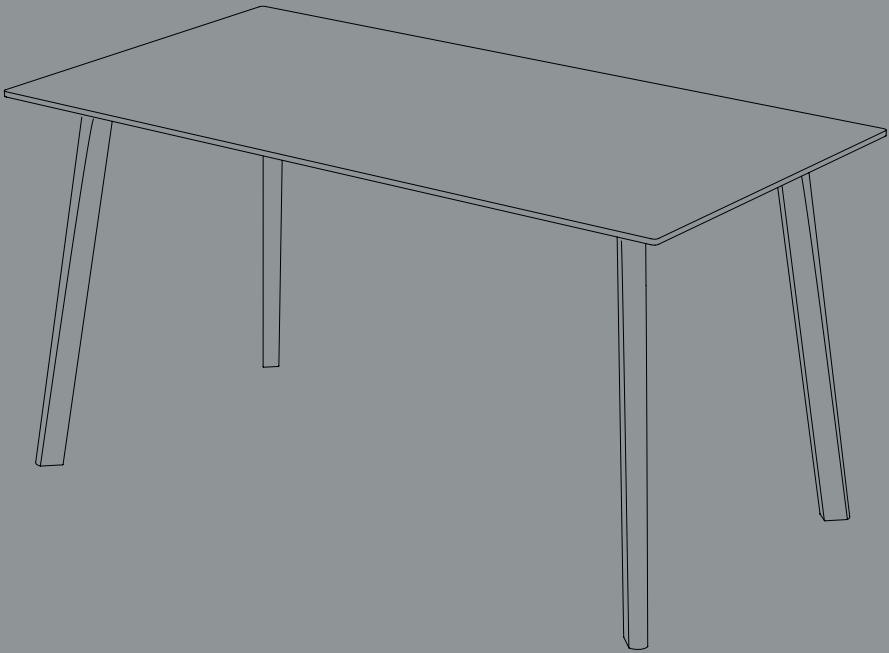

DESIGN BY RONAN & ERWAN BOURoulLEC

# HAY



- PARTS -

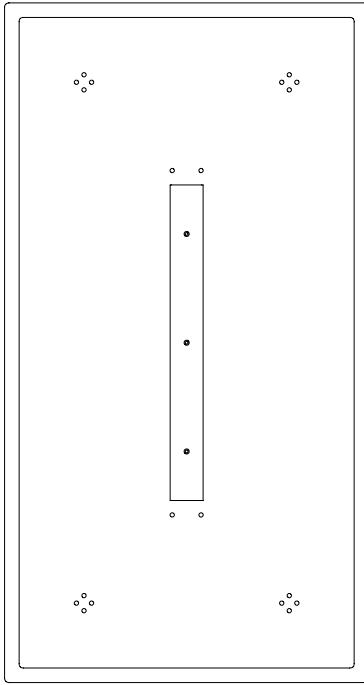

**A** Table top x1

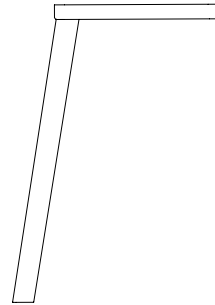

**B** Leg x4

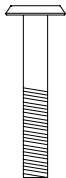

**C** Screw x20



**D** Allen key x1

Protect the table top from scratches and other damage while assembling.

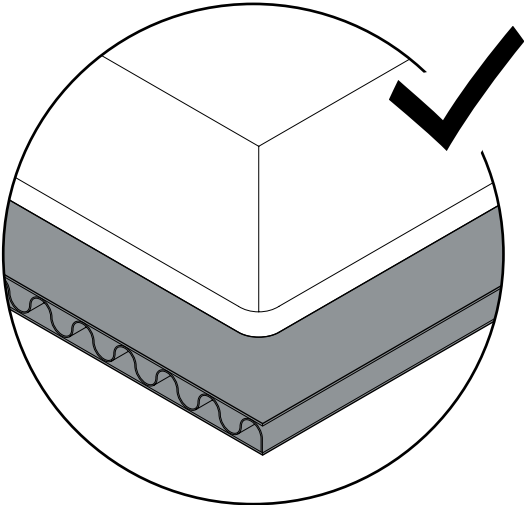
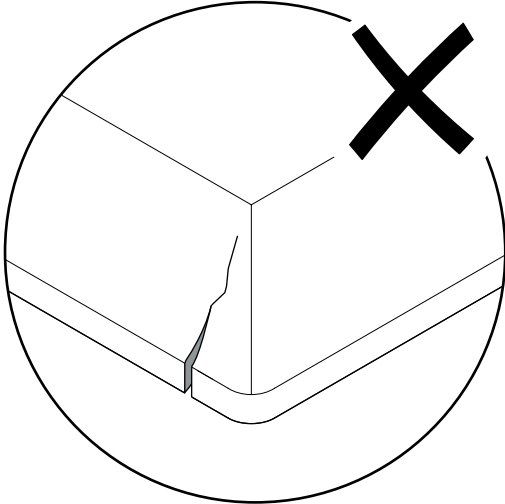

1.

Place the **B** parts on the reverse side of **A** and align them with the holes.  
Insert the **C** parts into the holes and gently tighten them.

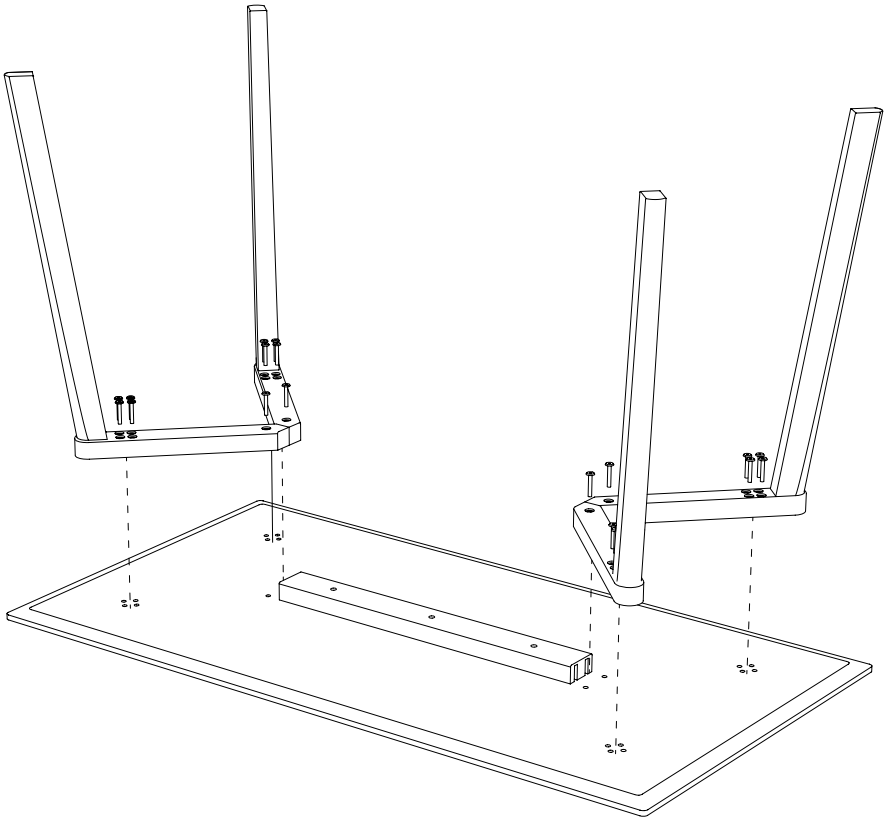

2.

Use the Allen key to tighten the **C** parts completely.

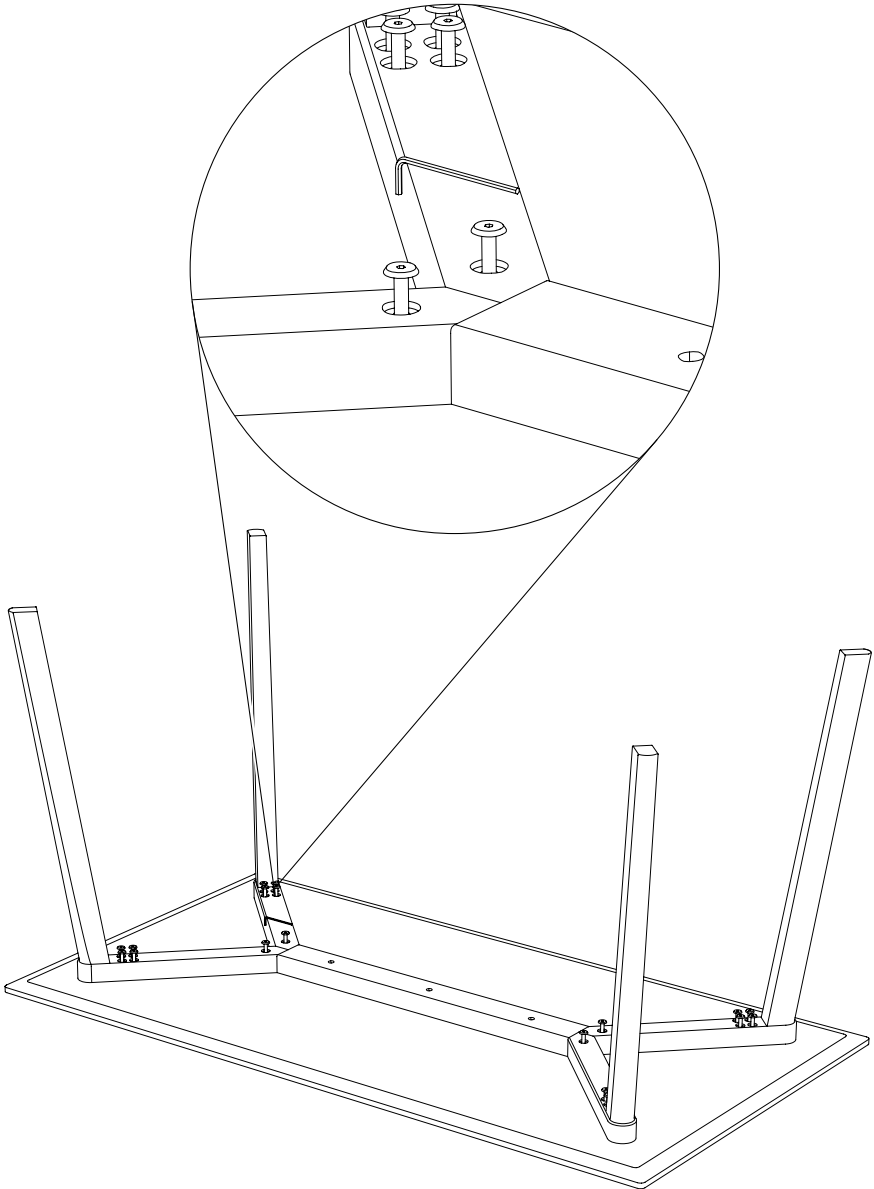

3.

Turn the table over (2 persons recommended).

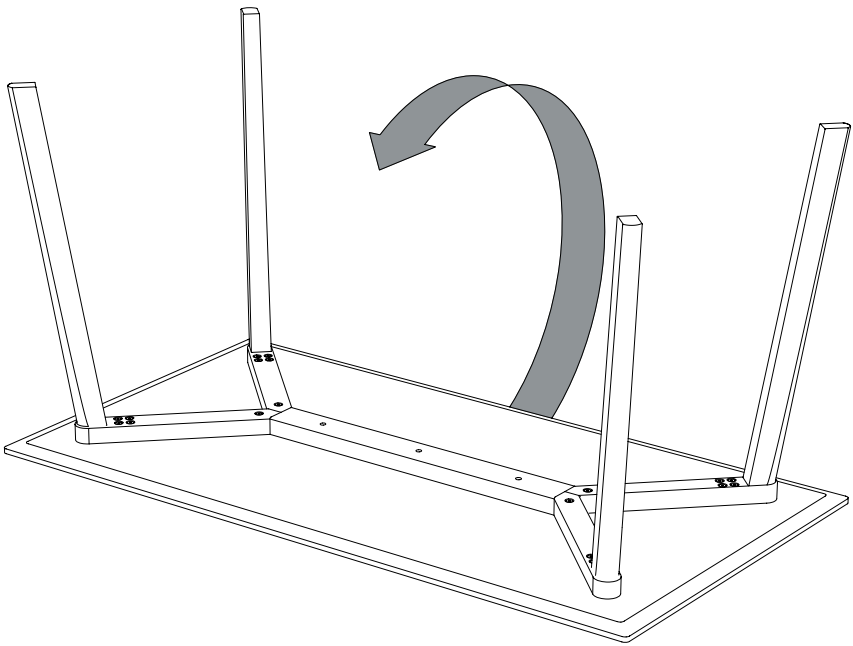

4.

Done!

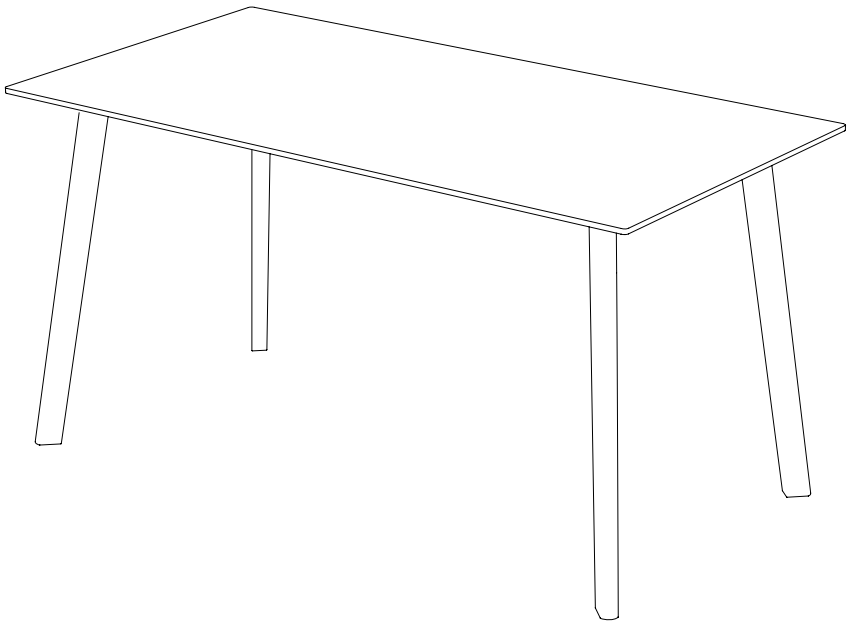



- CARE & MAINTENANCE -

Our Care & Maintenance offers guidance for optimal maintenance of your HAY product. It includes advice and instructions on cleaning and caring for specific materials to prolong the life of your furniture.



Please find our Care & Maintenance guide by scanning the QR code



You can find more relevant information on CPH Deux 210 by scanning the QR code

You can also find the same information here  
[hay.dk/downloads](http://hay.dk/downloads)

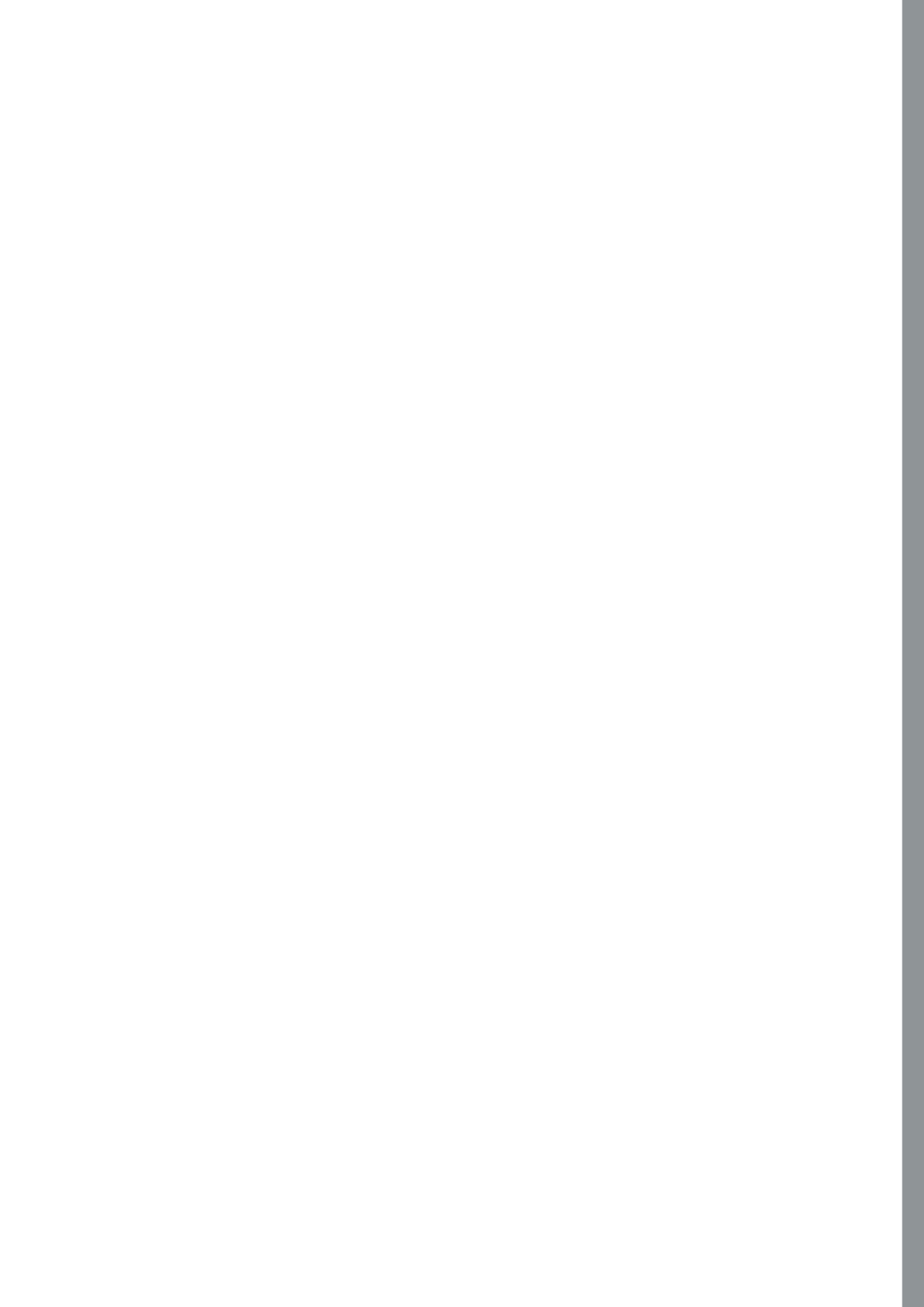



Havnen 1 8700 Horsens Denmark  
+45 4282 0282 / hay@hay.com

06/10/2021

**HAY**