

- INSTRUCTION MANUAL -

CPH 90 DESK

L130 X W65 X H74

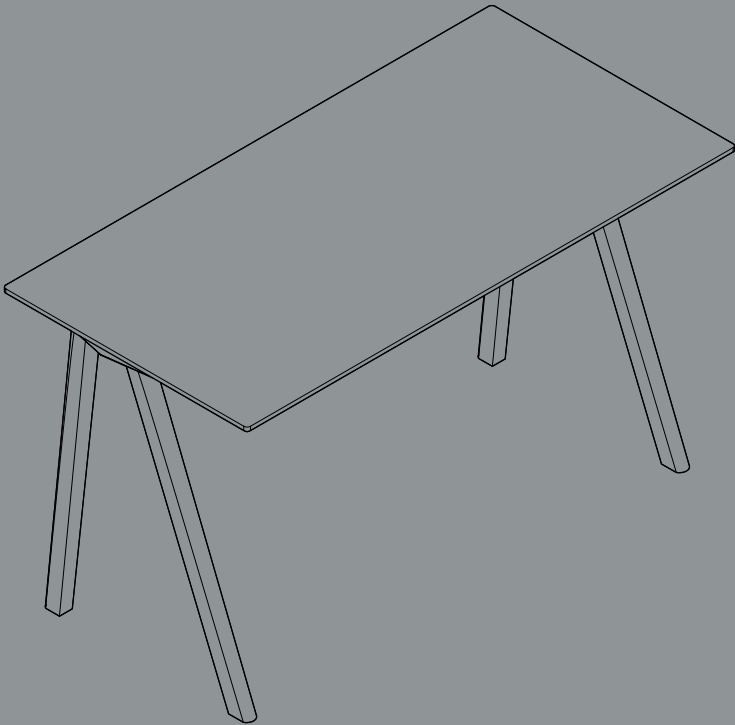

DESIGN BY BY RONAN & ERWAN BOURULLEC

HAY

- PARTS -

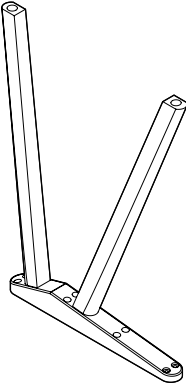

A Leg x2

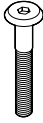

B Screw x8

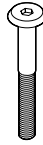

C Screw x11



D Allen key

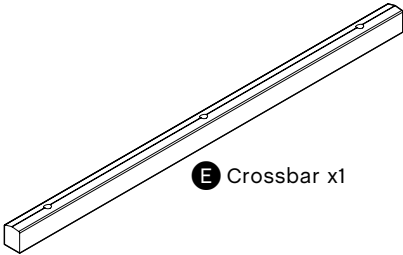

E Crossbar x1

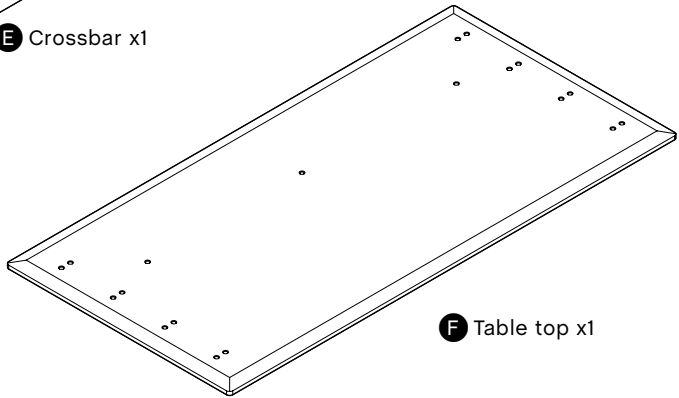

F Table top x1

Protect the table top from scratches and other damage while assembling.

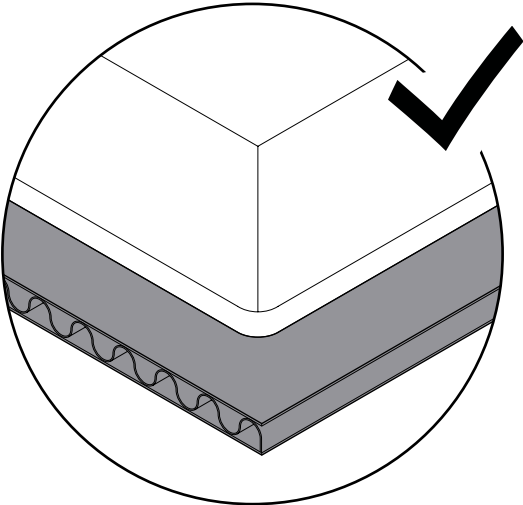
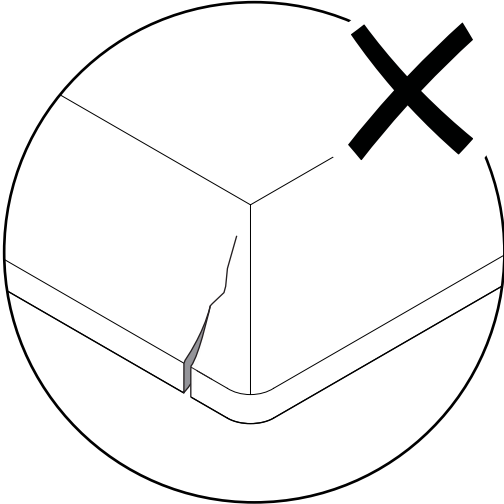

1.

Place the crossbar **E** on the table top **F** and fasten it with the screws **C** using the Allen key **D**. Make sure all the screws are inserted and tightened loosely, before tightening them completely.

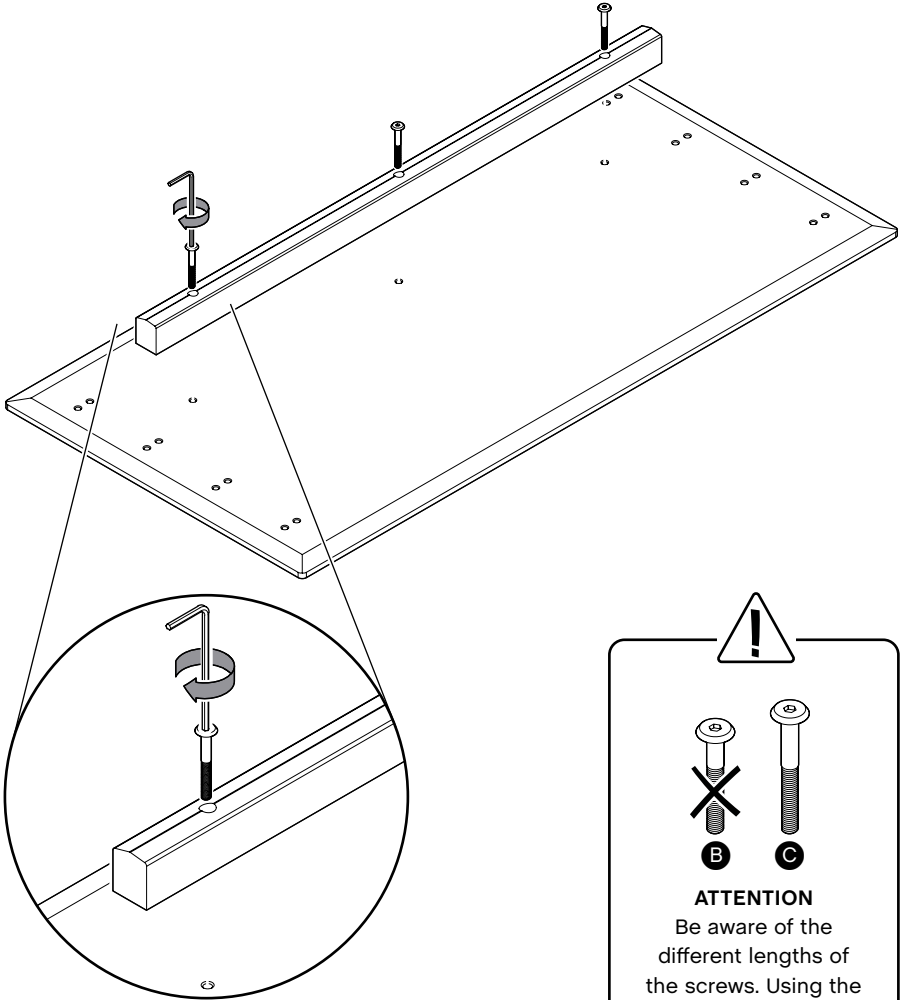

ATTENTION
Be aware of the different lengths of the screws. Using the incorrect screw could damage the table.

2.

Place the legs **A** on the table top **E** and fasten them with the screws **B** and **C** using the Allen key **D**. Make sure all the screws are inserted and tightened loosely, before tightening them completely.

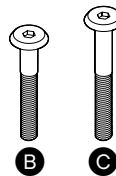
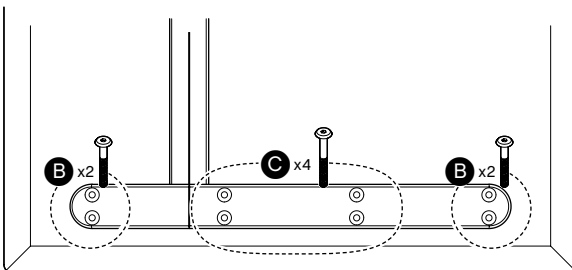
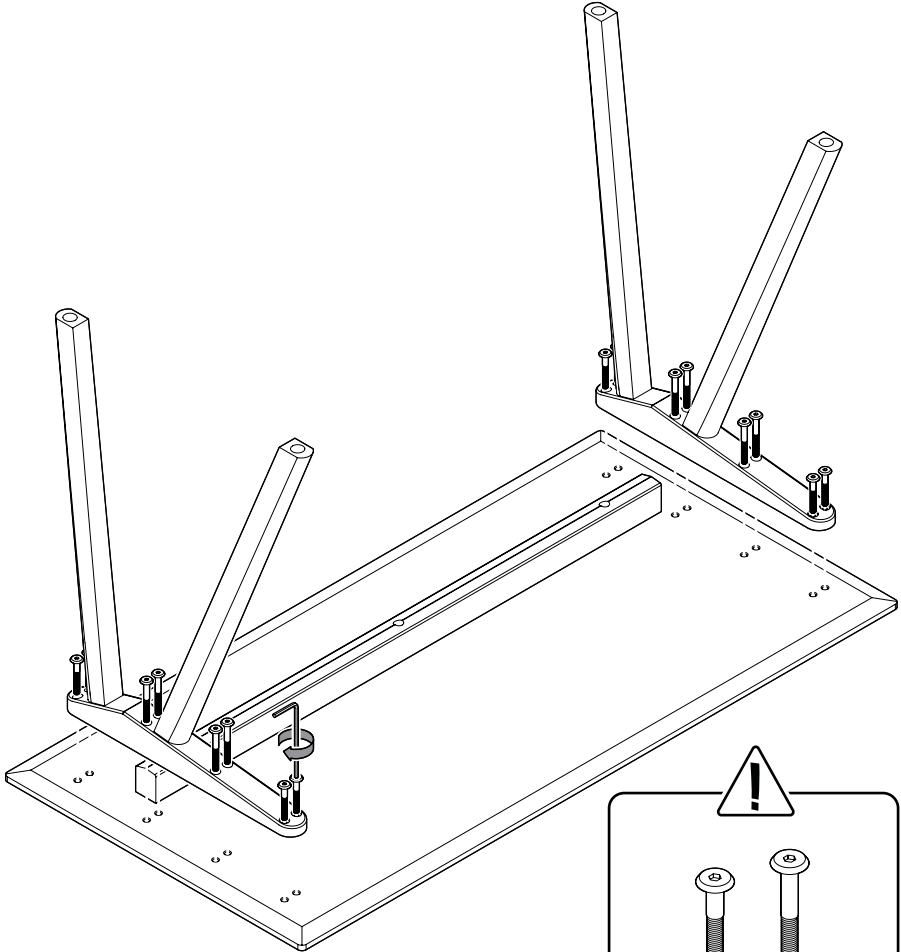

ATTENTION

Be aware of the different lengths of the screws. Using the incorrect screw could damage the table.

3.

Turn the table over. (2 persons recommended).

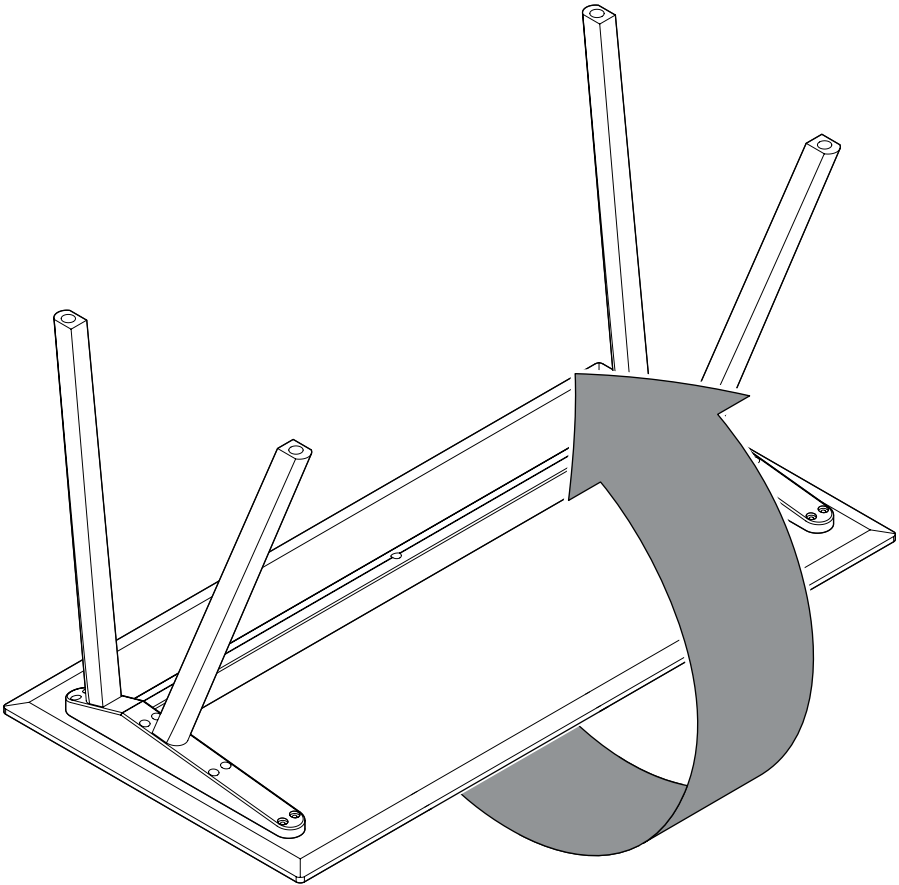

4.

If the floor is uneven and the table is wobbly, you can turn the feet to adjust them up and down to stabilise the table.

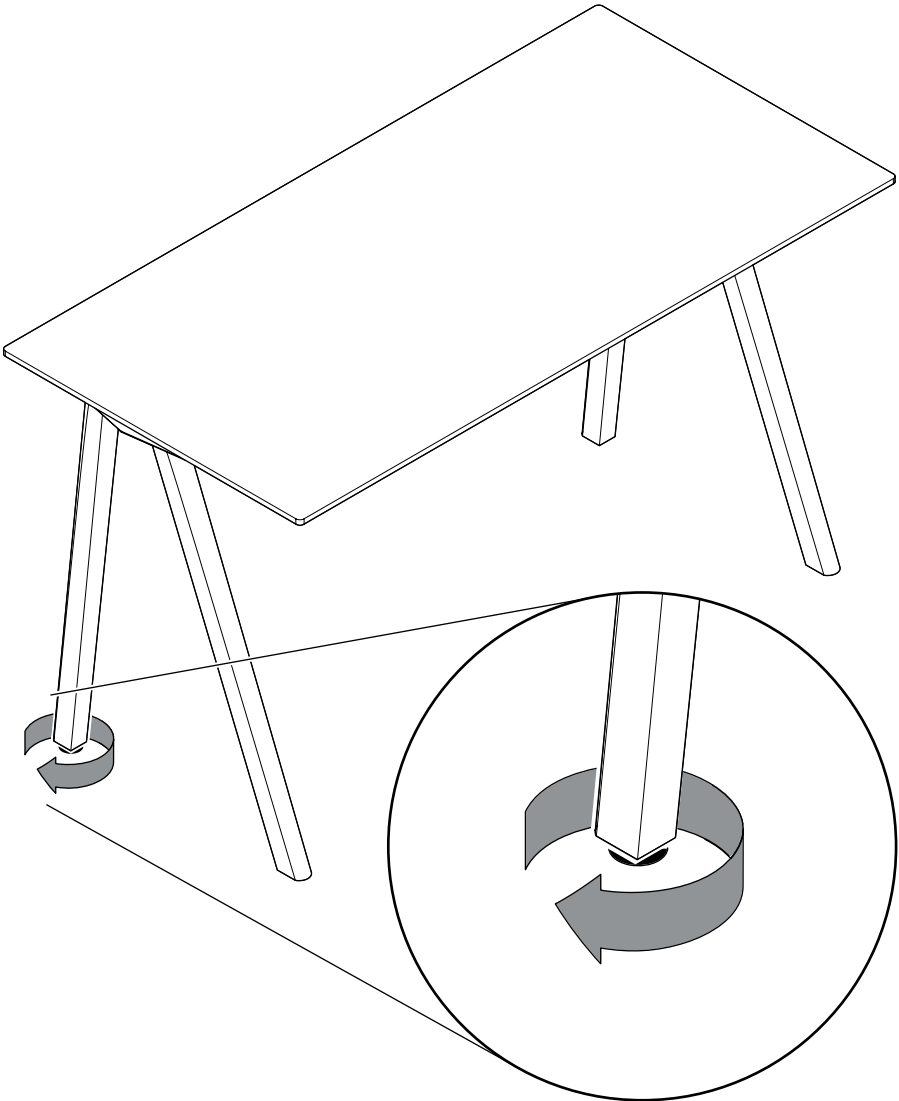

- CARE & MAINTENANCE -

Our Care & Maintenance offers guidance for optimal maintenance of your HAY product. It includes advice and instructions on cleaning and caring for specific materials to prolong the life of your furniture.



Please find our Care & Maintenance guide by scanning the QR code



You can find more relevant information on CPH 90 Desk by scanning the QR code

You can also find the same information here
hay.dk/downloads

Havnen 1 8700 Horsens Denmark
+45 4282 0282 / hay@hay.com

06/10/2021

HAY