

Thank you for purchasing the OREI HDMI Extender. For optimum performance and safety please carefully read the instructions and keep them for future reference.

• IMPORTANT SAFETY NOTICE

1. Do not mix up the transmitter unit (TX) and the receiver unit (RX), IR blaster extension cable and IR receiver extension cables before installation.
2. Do not unplug while the device is in use.
3. Power the device using the included 5V DC power supply adapter only. If using other adapters please make sure the specs are identical.
4. Static electricity will damage this item. Please follow ESD protection guidelines while installing this device.

• INTRODUCTION

The OREI **HD14-EX132-K** HDMI extender kit includes 1 transmitter and 4 receivers which allows you transmit 1080P HDMI signal to 4 displays up to 132 ft via Cat/6A/7 LAN cable. This kit supports IR passback with wide IR frequency between 20~60KHz.

• PACKAGE CONTENTS



Transmitter unit x1pcs



Receiver unit x4pcs



DC5V/3A x1pcs

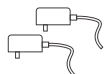

DC5V/1A x4pcs

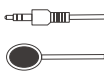

IR blaster extension cable x1pcs



IR receiver extension cable x4pcs



User Manual x1pcs

• FEATURES

1. Distribute 1 HDMI source to 4 HD displays over Lan Cables
2. Supports 1080P signal up to 132 ft over LAN
3. Supports CAT6/6A/7 LAN Cables
4. Plug & play easy set-up without software installation
5. Support 20-60KHz IR passback
6. Support one HDMI loop-out and EDID management

• INSTALLATION REQUIREMENTS

1. HDMI source device(computer graphics card, DVD,PS3, HD monitoring equipment etc).
2. HDMI display device like SDTV, HDTV, and projector with HDMI port.
3. UTP/STP CAT6/6A/7 cable, follow standard IEEE-568B.

• FUNCTION

1. Transmitter unit (TX)

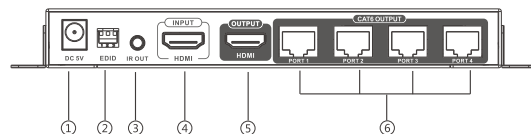

• FEATURES

1. Distribute 1 HDMI source to 4 HD displays over Lan Cables
2. Supports 1080P signal up to 132 ft over LAN
3. Supports CAT6/6A/7 LAN Cables
4. Plug & play easy set-up without software installation
5. Support 20-60KHz IR passback
6. Support one HDMI loop-out and EDID management

• INSTALLATION REQUIREMENTS

1. HDMI source device(computer graphics card, DVD,PS3, HD monitoring equipment etc).
2. HDMI display device like SDTV, HDTV, and projector with HDMI port.
3. UTP/STP CAT6/6A/7 cable, follow standard IEEE-568B.

• FUNCTION

1. Transmitter unit (TX)

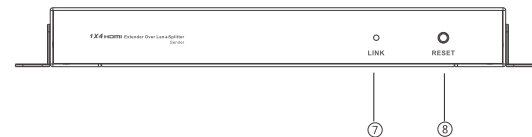
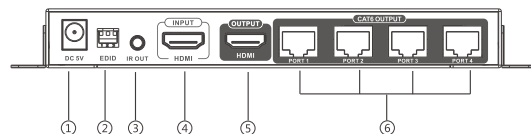

- ① Power input (DC5V)
- ② EDID switch
- ③ IR signal output to connect with blaster extension cable
- ④ HDMI input
- ⑤ HDMI output
- ⑥ RJ45 signal output
- ⑦ Power/ signal indicator
- ⑧ Reset button

2. Receiver unit (RX)

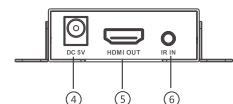
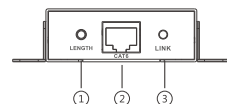

- ① LENGTH: for adjusting to the length of network cable
- ② RJ45 signal input
- ③ RJ45 indicator led it lights on all the time with HDMI signal transmission, flashes with no signal transmission
- ④ DV5V power input
- ⑤ HDMI signal output
- ⑥ IR signal input to connect with IR receiver extension cable

Remarks: The LENGTH key is designed for switching between automatic and manual setting to adjust cable length. Powered on without any operation, extender works with parameter set and memorized before. Powered on and then press LENGTH key, The first two press, it will entering automatic mode to adapt cable length. The following 12 times of pressing, it will entering manual mode in 12 levels to meet different cable length. After all 12 levels of press, it will entering auto mode again and into next loop.

• Installation Procedures

1. How to make a CAT5/5E/6 network cable

Follow the standard of IEEE-568B:

- | | |
|-----------------|-----------|
| 1- Orange/white | 2- Orange |
| 3- Green/white | 4- Blue |
| 5- Blue/white | 6- Green |
| 7- Brown/white | 8- Brown |



2. Connection

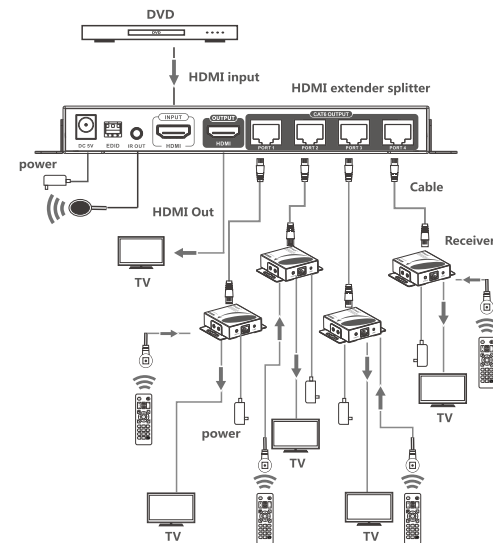

Remarks: Please do not remote control two or RX units' IR cable at the same time, which to avoid interference.

3. Connection instruction:

- 1) Connect the HDMI signal source device to the Transmitter HDMI input port with HDMI cable.
- 2) Connect IR blaster to EXTENDER IR OUT
- 3) Connect the Transmitter RJ45 port to HDMI EXTENDER RX's Rj45 input port by network cable.
- 4) Connect HDMI EXTENDER RX's HDMI output port to HDMI display's HDMI input port by HDMI cable and set the HDMI display's signal source to be HDMI port.
- 5) Supply the power(Power's signal light is red, when there are signal input then the power light is blue),the product will work.

4.EDID Setting

- 1) HDMI source device reads the EDID information of the transmitter (TX) and then output the relative HDMI signal format.
- 2) There are 8 build-in EDID status, and others could be selected by the EDID switch in the HDMI extender splitter(transmitter), the detail Setting Information shown as below:



Switch UP : use the Arabic numeral "1" to represent



Switch DOWN : use the Arabic numeral "0" to represent

	SW1	SW2	SW3	EDID Mode
Switch Status	0	0	0	720P@50Hz 2.1CH
	1	0	0	720P@50Hz 7.1CH
	0	1	0	1080i@60Hz 2.1CH
	1	1	0	1080i@60Hz 7.1CH
	0	0	1	1080P@60 2.1CH
	1	0	1	1080p@60Hz 7.1CH
	0	1	1	Read Loop-out(if not connect the loop-out show default)
	1	1	1	Default 720P@50Hz 2.1CH

• FAQ

Q : No image or audio output on display ?

- A: 1) Please check whether display on standby mode;
2) Please check whether display HDMI signal channel in accord with HDMI input port;
3) Please check whether " LINK " LED on RX side keeps on, LED flash means RX does not receive signal from TX;
4) Please check whether signal indicator LED on TX turns blue, LED on red means no input signal;
5) Please check whether input resolution supported by this product.

Q : Image unstable ?

- A: 1) Press the "LENGTH" or "RESET" button on the transmitter to re-identify the signal;
2) Please pull & plug CAT cable on corresponding port to reconnect.

Q : Only partial ports have output ?

- A: 1) Please check whether CAT cable or HDMI cable connected correctly;
2) Press the "LENGTH" or "RESET" button on the transmitter to re-identify the signal;
3) Please pull & plug CAT cable on corresponding port to reconnect.

• SPECIFICATION

Items	Specifications
HDMI signal	HDMI1.3, Compatible with HDCP1.2
Input	1 x HDMI
Output	4 x RJ45
Support resolutions	480i@60Hz, 480p@60Hz, 576i@50Hz, 576p@50Hz, 720p@50/60Hz, 1080i@50/60Hz, 1080p@50/60Hz
Transmit distance	Full HD resolution 1080p@60Hz up to 40 meters via CAT6 cable
IR signal	Support 20~60kHz IR device

EDID	Support EDID setting function
Working temperature	0°C ~ 60°C
Power supply	DC5V/3A
Power Consumption	<15W
Dimension	TX: 190(L) x 95.9(W) x 23.9(H) mm RX: 71.6×66.6×22.6mm
Color	Black

Disclaimer

OREI is a registered trademark of OREI, LLC The pictures in the user manual are for reference only and there may be a slight difference in the appearance of the actual product. We reserve the right to make changes without further notice to a product or system described herein to improve its reliability and functionality.



1080P Uncompressed 1X4 HDMI Splitter
Over 40meter Cat6 with IR

HD14-EX132-K User manual

