

 深圳市玩视科技有限公司 SHENZHEN HDCVT TECHNOLOGY CO., LTD	File No.	RD-I-19-006
	Version	1.0
HDV-E5100 User Manual	Effective Date	2019-3-12
	Page	2 / 21

Approval :	Approve by :	Issue : 刘晨风
Date :	Date :	Date : 2019/3/12



深圳市玩视科技有限公司
SHENZHEN HDCVT TECHNOLOGY CO., LTD

File No. RD-I-19-006

Version 1.0

HDV-E5100 User Manual

Effective Date 2019-3-12

Page 1 / 21

HDMI over IP Extender with Loop out (100M)



User Manual

VER 1.0

Thank you for purchasing this product

For optimum performance and safety, please read these instructions carefully before connecting, operating or adjusting this product. Please keep this manual for future reference.

 深圳市玩视科技有限公司 SHENZHEN HDCVT TECHNOLOGY CO., LTD	File No.	RD-I-19-006
	Version	1.0
HDV-E5100 User Manual	Effective Date	2019-3-12
	Page	2 / 21

Surge protection device recommended

This product contains sensitive electrical components that may be damaged by electrical spikes, surges, electric shock, lightning strikes, etc. Use of surge protection systems is highly recommended in order to protect and extend the life of your equipment.

Table of Contents

1. Introduction	3
2. Features	3
3. Package Contents	4
4. Specifications	5
5. Operation Controls and Functions	6
5.1 Encoder Panel	6
5.2 Decoder Panel	7
6. The Computer plays Video Stream	8
6.1 Web GUI introduction	8
6.2 VLC media player instruction	14
7. Application Example	19
8. FAQ	21

1. Introduction

HDMI over IP Extender is based on AV over IP solution for distribution of one HD content to one HD display device or to multiple HD display devices over a standard 1G network switcher, and extends distance up to 100m/328ft between

 深圳市玩视科技有限公司 SHENZHEN HDCVT TECHNOLOGY CO., LTD	File No.	RD-I-19-006
	Version	1.0
HDV-E5100 User Manual	Effective Date	2019-3-12
	Page	3 / 21

encoder and decoder via Cat5e/6 cable. It offers configurable high quality, low-bandwidth H.265 compression video. The resolution up to 1920x1200@60Hz YCbCr 4:4:4. It also supports HDMI loop output.

HDMI over IP Extender includes two units: Encoder unit and Decoder unit. Encoder unit is used to capture the HDMI input with IR blaster signal and carries the signals via one effective Cat5e/6 cable, and Encoder unit can also support HDMI loop output. The Decoder unit is responsible for outputting HDMI signal from Encoder unit with IR receiver signal. The product offers the most convenient solution for HDMI extension over a single Cat5e/6 and is the perfect solution for any application.

2. Features

- ② HDMI 1.4b, HDCP 1.4 compliant
- ② Supports 10.2Gbps bandwidth
- ② Video resolution up to 1920×1200@60Hz YCbCr 4:4:4
- ② Extend distance up to 100m/328ft between encoder and decoder via Cat5e/6 cable
- ② Support standard H.265 encoding / decoding
- ② Support 1G standard IP switcher / router / hub
- ② Support one-way IR control
- ② Compact design for easy and flexible installation

3. Package Contents

- ① 1× HDMI over IP Encoder
- ② 1× HDMI over IP Decoder
- ③ 1× Wideband IR Blaster cable
- ④ 1× Wideband IR Receiver cable
- ⑤ 2× 5V/1A Power Adapters
- ⑥ 1× User Manual

 深圳市玩视科技有限公司 SHENZHEN HDCVT TECHNOLOGY CO., LTD	File No.	RD-I-19-006
	Version	1.0
HDV-E5100 User Manual	Effective Date	2019-3-12
	Page	4 / 21

4. Specifications

Technical	
HDMI Compliance	HDMI 1.4b
HDCP Compliance	HDCP 1.4
Video Bandwidth	10.2Gbps
Video Resolution	640x480@60Hz~1920x1200@60Hz
HDMI Audio Formats	LPCM 2.0CH,48KHz
IR Frequency	20KHz ~ 60KHz
Compression Technology	H.265
Request for Switcher /Router	Support 1 GMP, Support DHCP
Color Space	RGB, YCbCr 4:4:4, YCbCr 4:2:2
Color Depth	8-bit
ESD Protection	Human body model—±8kV (Air-gap discharge) & ±4kV (Contact discharge)
Connections	
Encoder	Inputs: 1×HDMI Type A [19-pin female] Outputs: 1×HDMI Type A [19-pin female] 1×IR OUT [3.5mm Stereo Mini-jack] 1×CAT OUT [RJ45 connector]
Decoder	Inputs: 1×IR IN [3.5mm Stereo Mini-jack] 1×CAT IN [RJ45 connector]



深圳市玩视科技有限公司
SHENZHEN HDCVT TECHNOLOGY CO., LTD

File No. RD-I-19-006

Version 1.0

HDV-E5100 User Manual

Effective Date 2019-3-12

Page 5 / 21

Outputs: 1×HDMI Type A [19-pin female]

Mechanical

Housing Metal Enclosure

Silkscreen Color Black

Dimensions 88mm (W) × 61.2mm (D) × 16.5mm (H)

Weight Encoder: 155g, Decoder: 150g

Power Supply Input: AC100 - 240V 50/60Hz, Output: DC 5V/1A
(US/EU standards, CE/FCC/UL certified)

Power Consumption Encoder: 1.5W, Decoder: 1.25W

Operation Temperature -10°C ~ 50°C / 14°F ~ 122°F

Storage Temperature -20°C ~ 60°C / -4°F ~ 140°F

Relative Humidity 20~90% RH (non-condensing)

5. Operation Controls and Functions

5.1 Encoder Panel

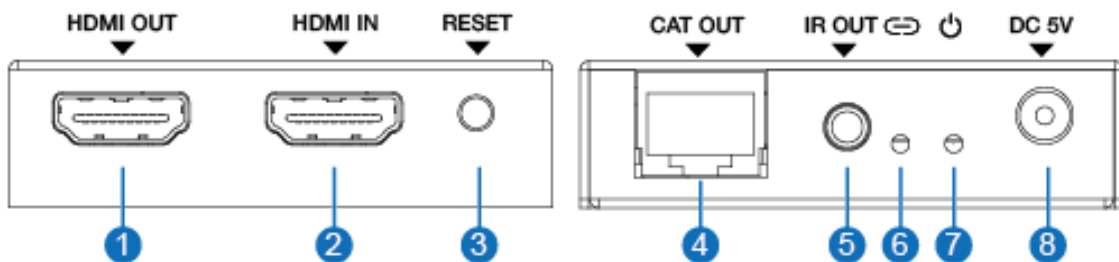

Number	Name	Function description
1	HDMI OUT	HDMI Loopout port, connect to HDMI display device such as TV or monitor with an HDMI cable.
2	HDMI IN	Connect to HDMI source device such as DVD player

 深圳市玩视科技有限公司 SHENZHEN HDCVT TECHNOLOGY CO., LTD	File No.	RD-I-19-006
	Version	1.0
HDV-E5100 User Manual	Effective Date	2019-3-12
	Page	6 / 21

		or set-top box with an HDMI cable.
3	RESET button	Reset the product, including IP address, encoding information and EDID. The EDID will recover default status for 1920*1080@60Hz
4	CAT OUT	The CAT OUT port is connected CAT IN port in Decoder or connected to switcher / router / hub with CAT cable for sending signal to Decoder. Notice: The CAT OUT is also a network port, it can be connected directly PC (through corresponding on-demand software such as VLC media player software.) to output signal from HDMI IN port.
5	IR OUT	Connect to wideband IR blaster cable. The IR blaster signal is from IR IN at the Decoder.
6	LINK LED	The LED will flash blue when Encoder is connected Decoder or connected switcher / router / hub.
7	POWER LED	The LED will illuminate blue when the Encoder is powered on.
8	DC 5V	Plug the DC 5V/1A power supply into the unit and connect the adapter to an AC outlet.

5.2 Decoder Panel

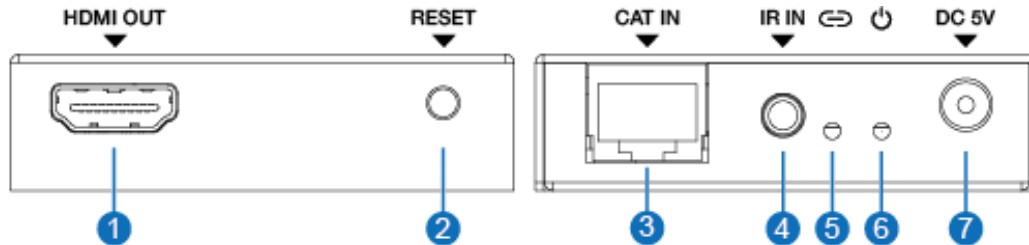

Number	Name	Function description
1	HDMI OUT	Connect to HDMI display device such as TV or monitor with an HDMI cable.
2	RESET button	<ul style="list-style-type: none"> Press the button briefly to reset the product, including IP address, encoding information and EDID. The EDID will recover default status for 1920*1080@60Hz. Press the button up to 3 seconds to copy EDID from Decoder display device to Encoder's HDMI source device.
3	CAT IN	The CAT IN port is connected CAT OUT port at the Encoder or connected switcher / router / hub with CAT cable for receiving Encoder signal.
4	IR IN	Connect to wideband IR receiver cable. The IR signal is sent to IR OUT port at the Encoder.
5	LINK LED	The LED will flash blue when Decoder is connected Encoder or connected switcher / router / hub.
6	POWER LED	The LED will illuminate blue when the Decoder is powered on.
7	DC 5V	Plug the DC 5V/1A power supply into the unit and connect the adapter to an AC outlet.

 深圳市玩视科技有限公司 SHENZHEN HDCVT TECHNOLOGY CO., LTD	File No.	RD-I-19-006
	Version	1.0
HDV-E5100 User Manual	Effective Date	2019-3-12
	Page	8 / 21

6. The Computer plays Video Stream

6.1 Web GUI introduction

The Encoder supports play video stream on computer through the corresponding on-demand software such as VLC media player, and you can connect the Web GUI of the product to control your on-demand software on the computer. The default IP address is 192.168.10.10. The operation method is shown as below:

Step 1: The CAT OUT port of the Encoder is connected directly the netport of a Computer with an UTP cable. The HDMI IN port of the Encoder is connected an source device such as DVD player with an HDMI cable. You can also connect an HDMI display device in HDMI loopout port such as TV. The Encoder is connected power supply. The connection diagram is shown as below.

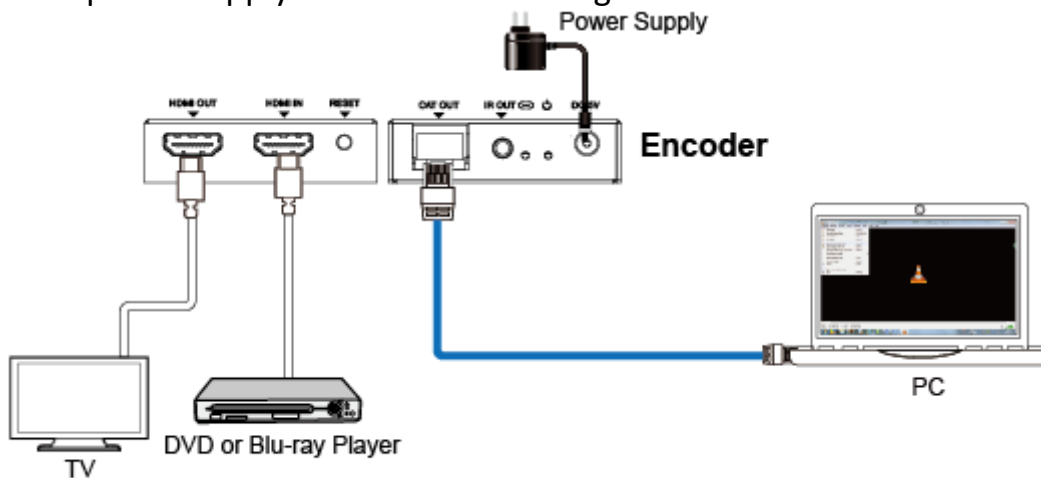
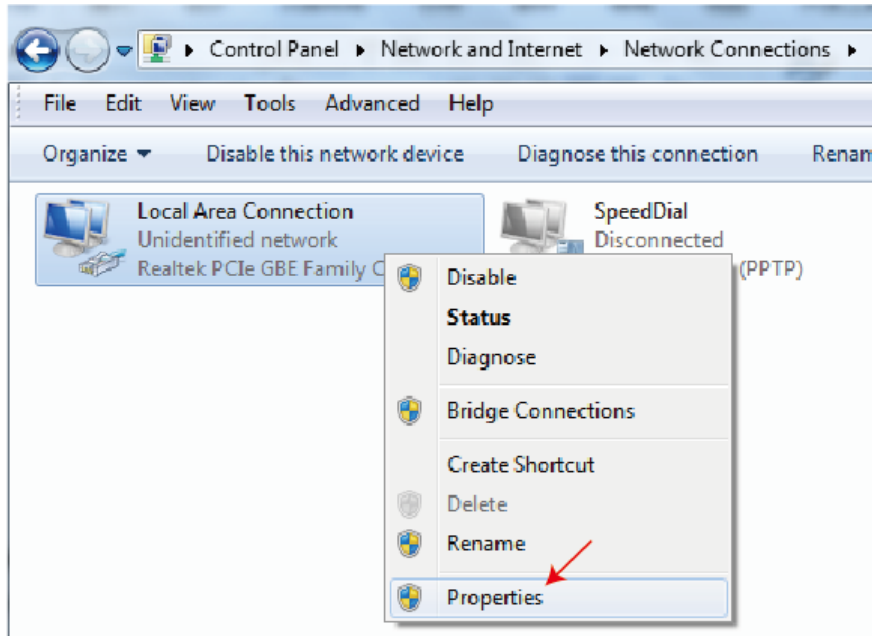

Figure 1: Video Stream connection diagram

Step 2: On the PC, go to **Control Panel > Network and Internet > Network Connections > Local Area Connections**, right click on it, choose **Properties**.

 深圳市玩视科技有限公司 SHENZHEN HDCVT TECHNOLOGY CO., LTD	File No.	RD-I-19-006
	Version	1.0
HDV-E5100 User Manual	Effective Date	2019-3-12
	Page	9 / 21



Double click Internet Protocol Version 4 (TCP/IPv4).

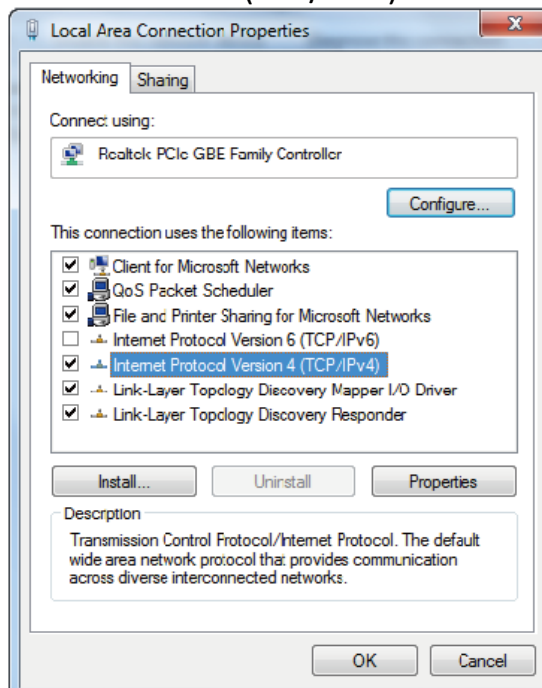

Choose “Use the following IP address”, input 192.168.10.200 as IP address, 255.255.255.0 as Subnet mask, and then click on OK, click on OK again.

 深圳市玩视科技有限公司 SHENZHEN HDCVT TECHNOLOGY CO., LTD	File No.	RD-I-19-006
	Version	1.0
HDV-E5100 User Manual	Effective Date	2019-3-12
	Page	10 / 21

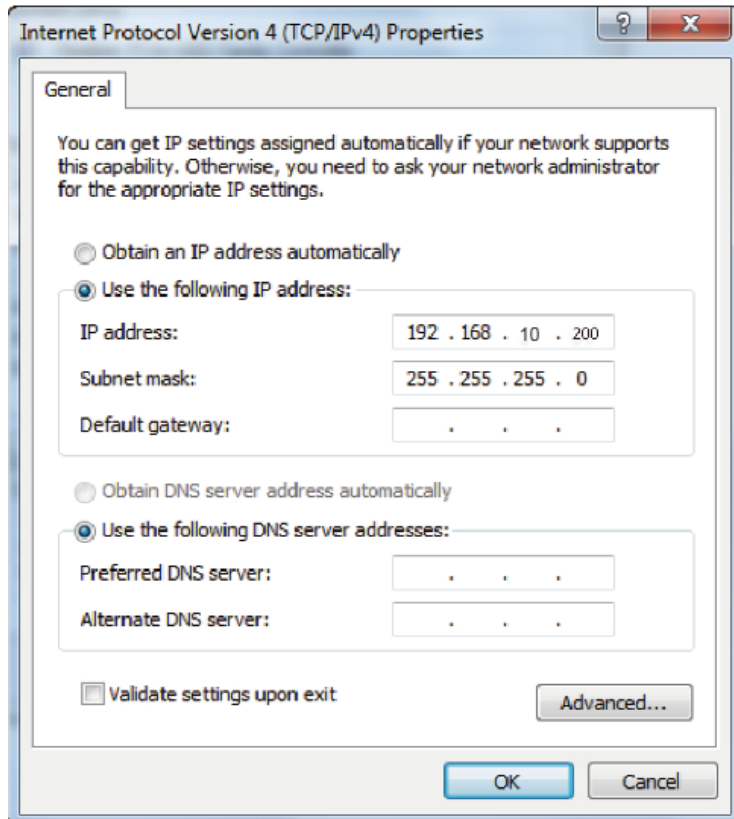

Notice: The IP address of the computer and Encoder should be in the same network segment. As the Encoder's IP address is 192.168.10.10, the computer's IP should be 192.168.10.X (X contains 1~255 except 10).

Step 3: Input the Encoder's IP address into your browser on the PC to enter Web GUI page, These pages are showed as below.

Video page

 深圳市玩视科技有限公司 SHENZHEN HDCVT TECHNOLOGY CO., LTD	File No.	RD-I-19-006
	Version	1.0
HDV-E5100 User Manual	Effective Date	2019-3-12
	Page	11 / 21

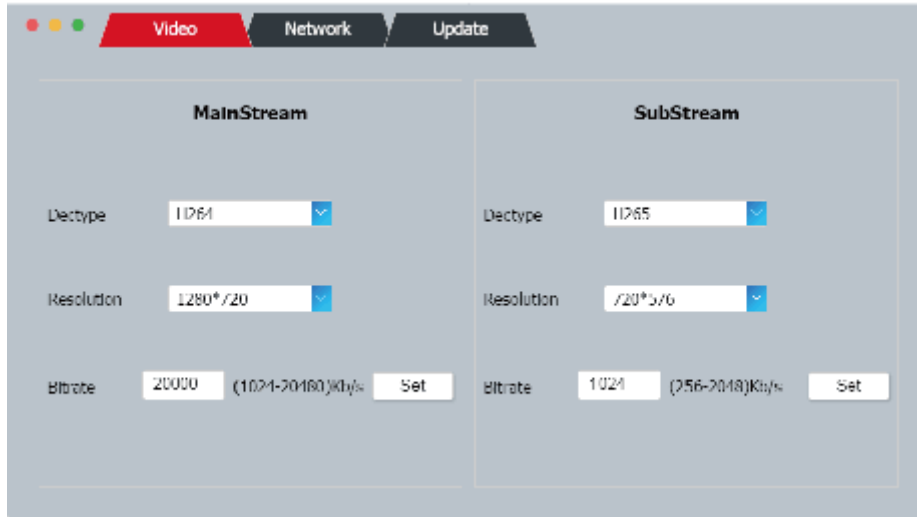

Dectype: There is a drop-down frame when you click the blue arrow area. You can choose H.264 or H265 code at MainStream or SubStream. Please see below picture 1.



Picture 1

Resolution: There is a drop-down frame when you click the blue arrow area. You can choose an output resolution. The MainStream resolution includes 1280*720 and 1920*1080, and the Substream resolution includes 352*288, 640*480, 720*576. Please see the below picture 2 and picture 3.



Picture 2

Picture 3

Bitrate: You can set bitrate at MainStream or SubStream, and then click “Set” button to confirm this operation. The MainStream range is from 1024Kb/s to 20480Kb/s and the SubStream range is from 256Kb/s to 2048Kb/s.

Note: You can only use either MainStream or SubStream in VLC media player. The MainStream has larger resolution and bitrate than the SubStream. So, the MainStream picture is clearer than the SubStream.

Network page

 深圳市玩视科技有限公司 SHENZHEN HDCVT TECHNOLOGY CO., LTD	File No.	RD-I-19-006
	Version	1.0
HDV-E5100 User Manual	Effective Date	2019-3-12
	Page	12 / 21

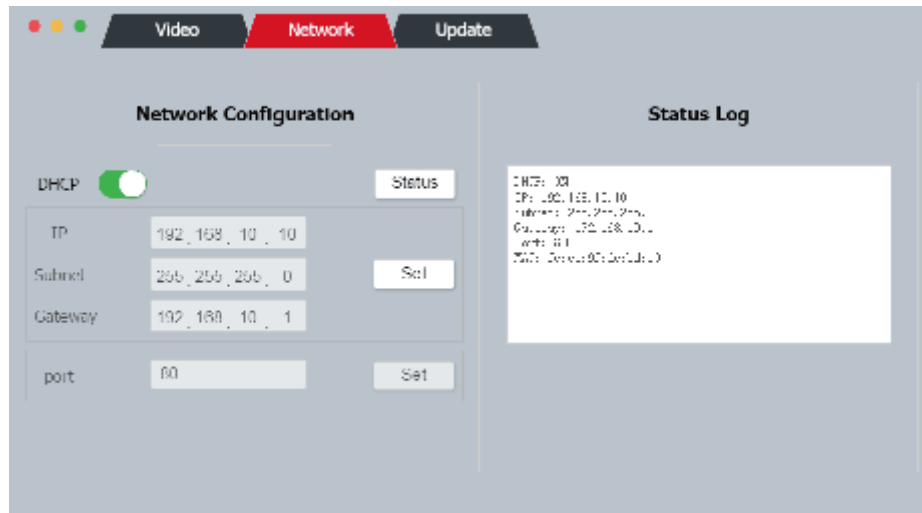

Network Configuration

 In DHCP open status:

DHCP switch: Obtain automatically the network configuration information, including IP address, Subnet, Gateway.

 In DHCP close status:

DHCP switch: If the DHCP switch has been closed, you can set IP, Subnet, Gate address. You must pay attention to the Gate address and the IP address in the same network segment. IP address and Gate address can not be the same in the last address. You don't need to change the Subnet address. In this moment, click the "Set" button to save current status information.

Note: If you have changed the Network Configuration and clicked the "Set" button. You have changed the IP address, and you can continue use current Web GUI function. But next time you connect Web GUI, you need to use the IP address that you set before. The IP address will recover default 192.168.10.10 when the product is set factory reset.

Status button: Clicking this button will refresh currently network configuration information to display in Status Log.

Status Log: Display the Net configuration information.

port: Set netport port value. The default value is 80.

Note: When you use the product alone, we suggest that you use the default IP setting. If you can not obtain the IP information as HDCP setting, you can press the "RESET" button of the Encoder to recover default IP address. The default IP address is 192.168.10.10.

 深圳市玩视科技有限公司 SHENZHEN HDCVT TECHNOLOGY CO., LTD	File No.	RD-I-19-006
	Version	1.0
HDV-E5100 User Manual	Effective Date	2019-3-12
	Page	13 / 21

Update page

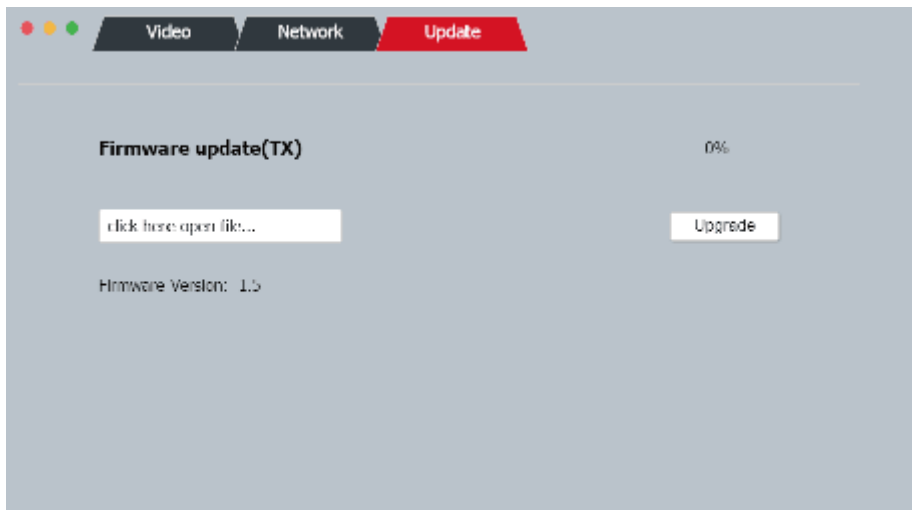

Firmware update port, open a bin. file and then click “Upgrade” button to update firmware.

Note: When the update file is too large, the upgrade progress could stay a long time in 99%.This is a normal phenomenon. Please do not turn off the power or press the “RESET” button until the upgrade progress up to 100%.

6.2 VLC media player instruction

When you have connected the Web GUI, then you need to open the VLC media player software on the computer. Double click the “VLC media player” shortcut icon. Please see the icon at picture 4.

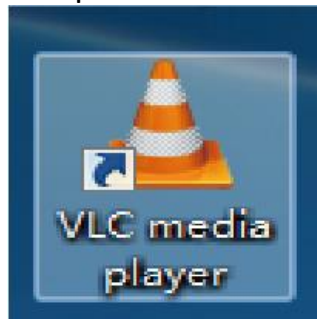

Picture 4

Step 1: Click “Media > Open Network Stream”

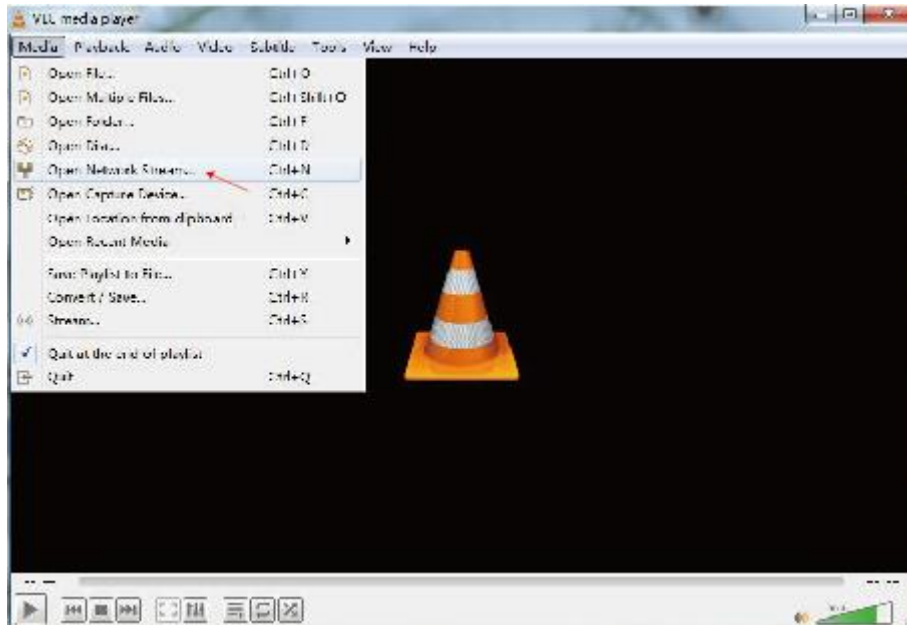

Step 2: At this time, you will see the following page. You need to enter a network URL. If you want to enter MainStream, please input a MainStream network URL. The MainStream is “rtsp://192.168.10.10/live/main/av_stream”. If you want to enter SubStream, please input a SubStream network URL. The SubStream is “rtsp://192.168.10.10/live/sub/av_stream”. Then click the “Play” button. Please see the following page.

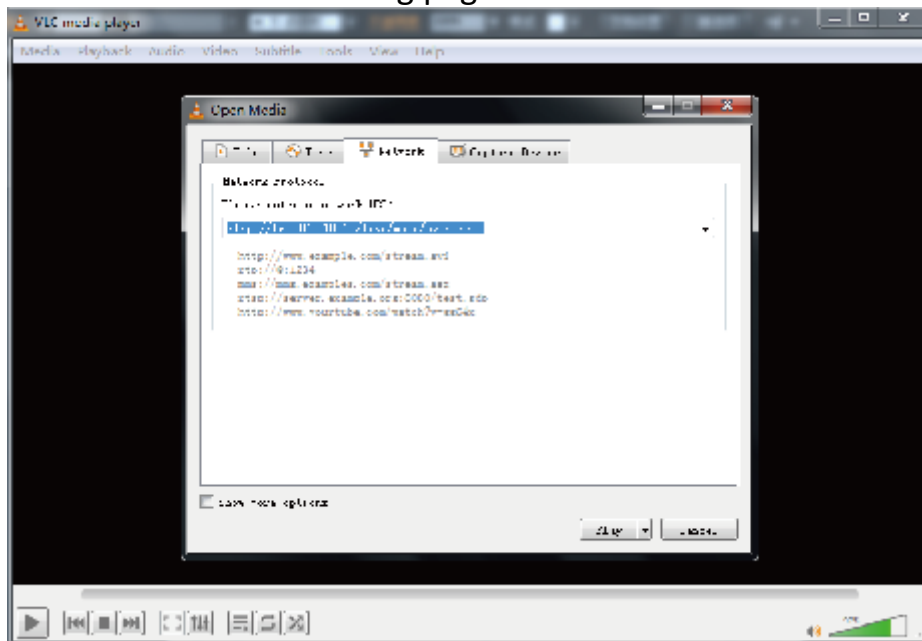

Note: ① If you enter a MainStream network URL, you can use the MainStream to control the VLC media player on the Video page of Web GUI. If you enter

 深圳市玩视科技有限公司 SHENZHEN HDCVT TECHNOLOGY CO., LTD	File No.	RD-I-19-006
	Version	1.0
HDV-E5100 User Manual	Effective Date	2019-3-12
	Page	15 / 21

a SubStream network URL, you can use the SubStream to control the VLC media player on the Video page of Web GUI.

② If the VLC media player is not work well, please check the IP address (the IP address of the computer and product should be in the same network segment.) and network connection status.

③ If everything is OK, the product boot static IP need to a little time to communication for router. Please try it more times.

Step 3: If you enter a MainStream network URL, you can use the MainStream of the Web GUI to setting the Dectype, Resolution and Bitrate value of the VLC media player.

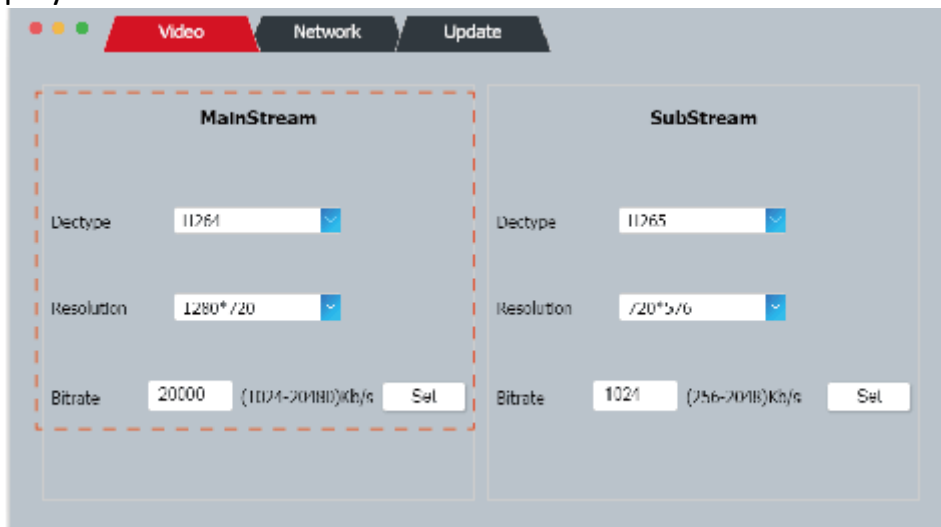

At the same time, you can check the setting on VLC media player. Choose “Tools>Codec information” to check current codec and resolution. Please see the following picture.



Choose “Tools>Codec information>Statistics” to check current bitrate. Please see the following picture.

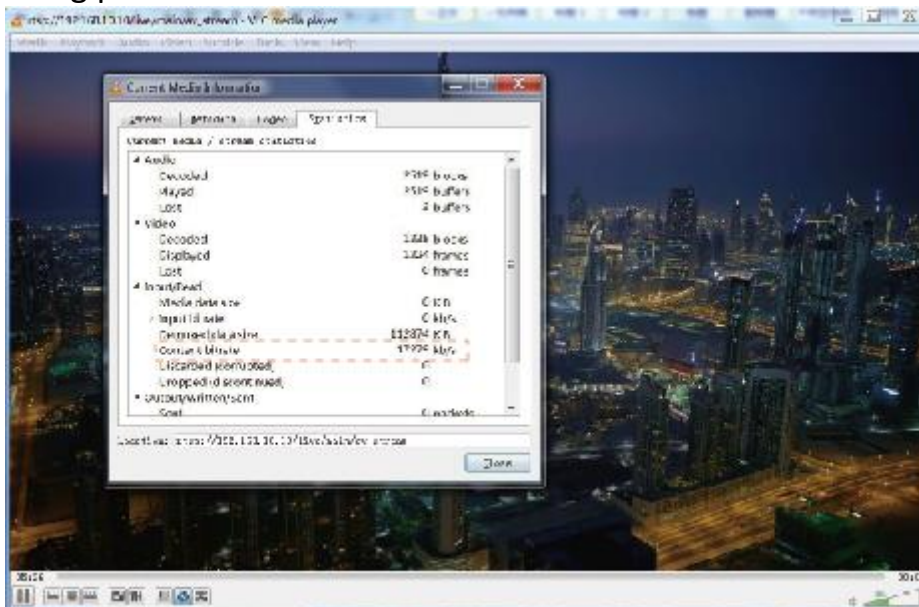

Note: The bitrate is floating up and down when you check it. This is a normal phenomenon.

7. Application Example

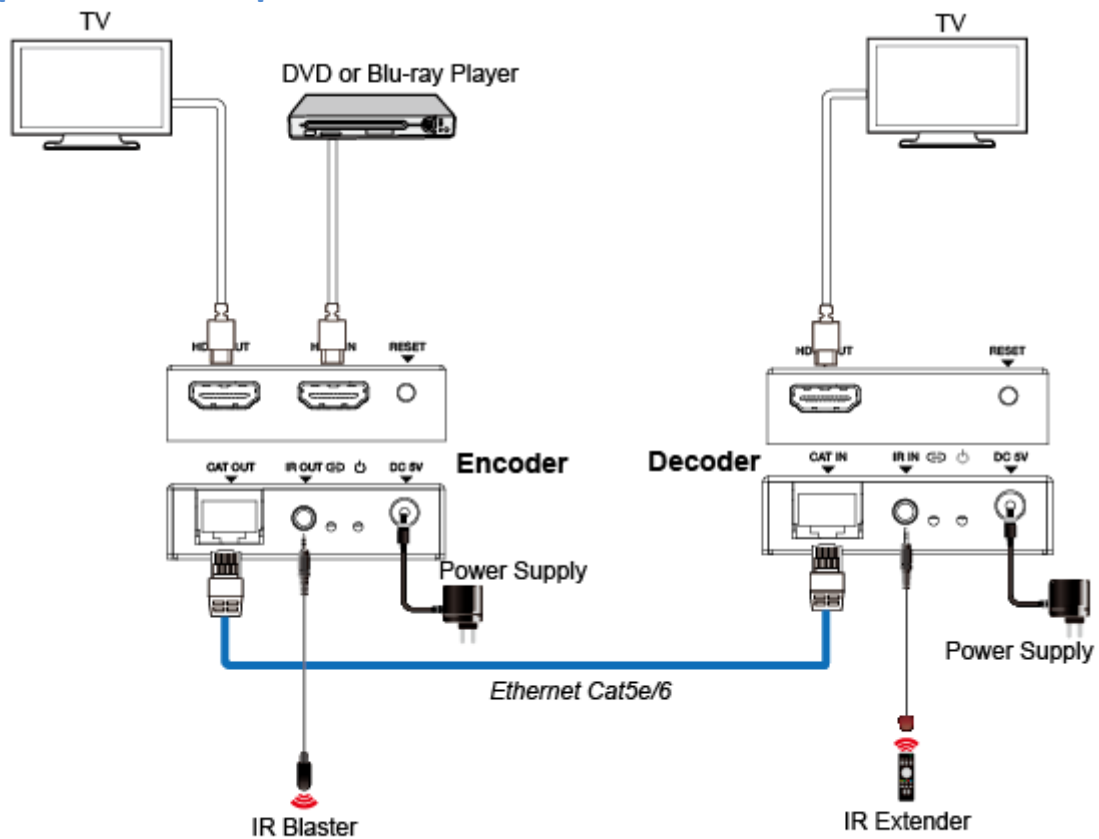

Figure 2: Encoder connects directly Decoder

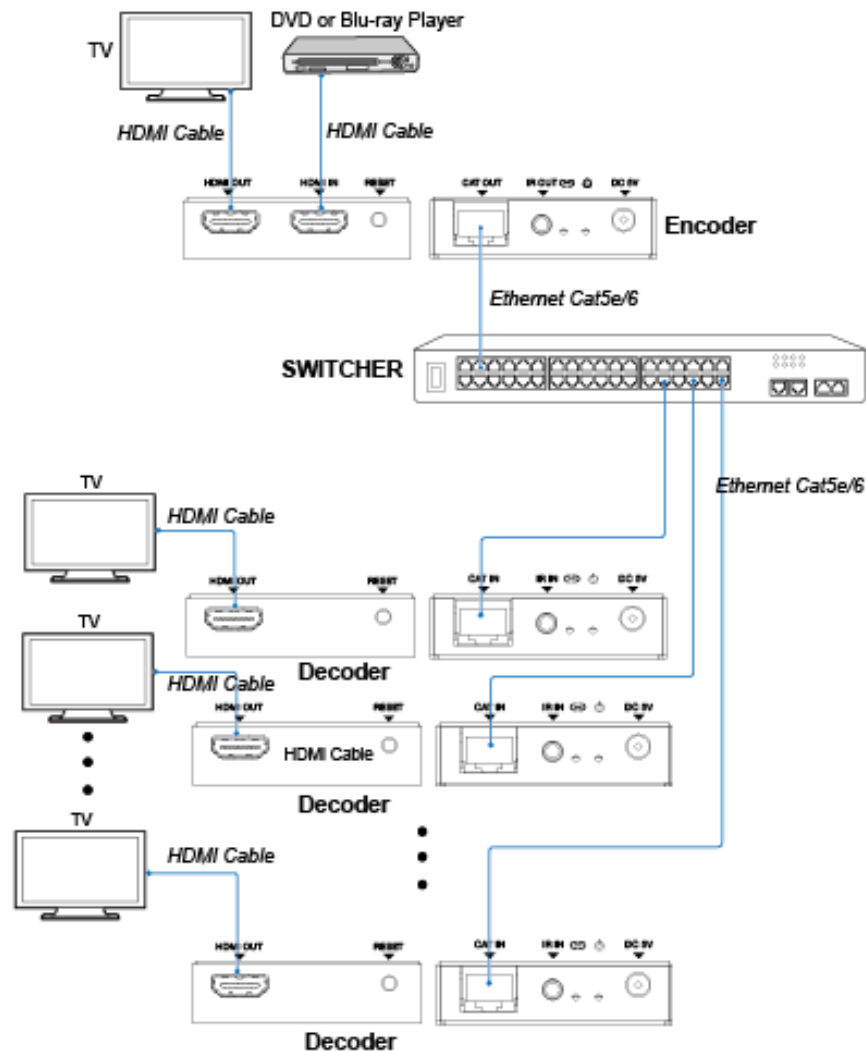

Figure 3: Encoder connects Decoder via switcher
(one Encoder to multiple Decoders)

8. FAQ

Q: Does this product require an line length for the connection interface?

A: According to HDMI line length test, 1920×1200@60Hz YCbCr 4:4:4 is the longest line length up to 15m/49.2ft. According to CAT line length test, using

 深圳市玩视科技有限公司 SHENZHEN HDCVT TECHNOLOGY CO., LTD	File No.	RD-I-19-006
	Version	1.0
HDV-E5100 User Manual	Effective Date	2019-3-12
	Page	19 / 21

CAT 5e/6 cable extends distance up to 100m/328ft between Encode and Decode.

The use of “Premium High Speed HDMI” cable is highly recommended.