

备注

H20018-ORE01说明书

物料编号：0106020147618

材质：100克书纸

尺寸：111x146mm

装订方式：骑马钉



**1080P HDMI Extender Over
70Meter Cat6 with Two-Way
IR & HDMI Loop-out**

www.orei.com

© 2022



**1080P HDMI Extender Over
70Meter Cat6 with Two-
Way IR & HDMI Loop-out**

USER MANUAL

Follow us on Youtube
and Facebook



www.orei.com

Table of Contents

Introduction	05
Features	06
Package Contents	06
Specifications	07
Operation Controls and Functions	09
Connection Diagram	11

Thank you for purchasing this product

For optimum performance and safety, please read these instructions carefully before connecting, operating or adjusting this product. Please keep this manual for future reference.

Surge protection device recommended

This product contains sensitive electrical components that may be damaged by electrical spikes, surges, electric shock, lightning strikes, etc. Use of surge protection systems is highly recommended in order to protect and extend the life of your equipment.

Registration page

Caution

Please Activate your warranty by registering our product through the link below - www.orei.com/register

Technical Support

Need Help?

Our experienced Technical Support Team is here for you to answer your questions, give technical advice or help troubleshoot your project to get you installed on time and on budget. Call, email or chat with us now.

OREI Live Technical Support Hours

US team (US/Canada/Mexico): Monday-Friday, 9 a.m. - 6 p.m. Central Time

Support Email - info@orei.com | **Support Number** - 877-290-5530

Or

Chat Live on www.orei.com

Send us an instant message now. Our Technical Support Team will respond momentarily. Available during live support hours.

The extender need to follow direct interconnection method CAT cable.

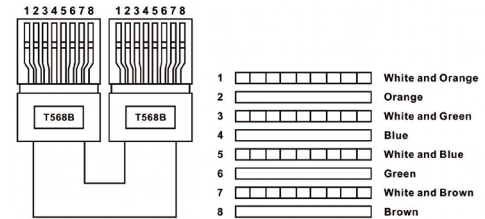

Direct interconnection method

The extender will go into protection mode automatically and no video out when using cross interconnection method CAT cable.

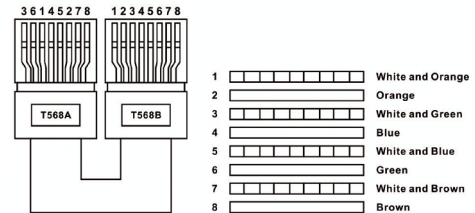

Cross interconnection method

Introduction

Features

This HDMI Extender includes a transmitter unit and a receiver unit, allows the HDMI signal to be transmitted up to 70 meters for 1080P@60Hz, and 40 meters for 4K@30Hz resolution using a Cat6/6A/7 network cable. It adopts a point-to-point connection configuration, supports bi-directional IR pass-back and 3.5 mm stereo audio output. It is perfect for outdoor advertising, monitor system, home entertainment, conference, etc.

1. Zero latency.
2. Support up to 4K@30Hz resolution.
3. Support CAT6/6A/7 network cables, 1080p@60Hz transmission distance is up to 70 meters, 4K30Hz transmission distance is up to 40 meters.
4. Support bi-directional IR pass-back function (20~60KHz).
5. Support HDR10.
6. Support EDID passthrough.
7. Transmitter supports HDMI loop-out.
8. Receiver supports 3.5mm stereo audio output.
9. Automatically adjusts parameters to match different network cables and achieve the best display performance.
10. Lightning Protection, Surge Protection, ESD Protection.



Package Contents

- 1 x Transmitter
- 1 x Receiver
- 2 x DC5V/500mA
- 1 x User manual
- 1 x IR receiver extension
- 1 x IR blaster extension

Specifications

Items		Specification
Power Supply	Voltage/Current	DC5V/500mA
	Power consumption	TX<2.5WRX<2.5W
HDMI Performance And Interface	HDMI compliance	HDMI 1.4
	HDCP compliance	HDCP 1.4
	HDMI resolution	800x600、1024x768、1280x720、1280x960、1366x768、1440x900、1680x1050、1920x1080、480i@60Hz、480p@60Hz、576i@50Hz、576p@50Hz、720p@50/60Hz、1080i@50/60Hz、1080p@24/25/30/50/60Hz、3840x2160@24/25/30Hz
	Supports audio formats	PCM, LPCM, DTS HD, DTS Audio
	Input and output TMDS signal	0.7-1.2Vp-p(TMDS)
	Input and output DDC signal	5Vp-p(TTL)
	Input cable length	≤8m(AWG24)
	Output cable length	≤8m(AWG24)
Transmission Distance	Cat6/6A/7	1080p@60Hz≤70m 4K@30Hz≤40m
Transmission Distance	Electrostatic protection of the whole machine	Implementation of the standard: IEC61000-4-2 1a Contact discharge level 2 (4KV) 1b Air discharge level 3 (8KV)

Specifications

Operating Environment	Working temperature	-20~60 C
	Storage temperature	-30~70 C
	Humidity (no condensation)	0~90%RH
Transmission Distance	Dimension	75.0(L) x 80.0(W) x 18.0(H)mm
	Material	Aluminum alloy material + crystal panel
	Treatment process	Crit blast
	Color	Black
	Weight	TX:160g RX:160g

Operation controls and functions

Transmitter

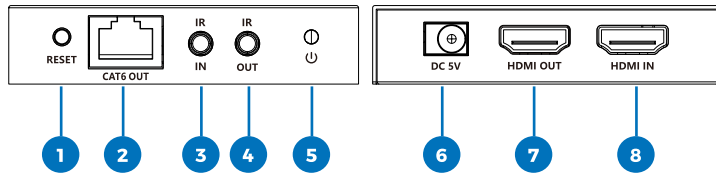

- 1 Reset button:** Press to restart the device.
- 2 RJ45 output:** Output modulated HDMI signal.
- 3 IR out:** Connect the IR receiver extension cable to ensure that the remote control used is within the range of the IR receiving device.
- 4 IR out:** Connect the IR blaster extension cable, please keep the infrared transmitter as close as possible to the signal source device when using.
- 5 Power/Signal indicator:**
 - When power is on and no HDMI signal is transmitted, the indicator flashes.
 - When power is on and HDMI signal is transmitted, the indicator is always on.
- 6 DC 5V input:** Connect to the 5V500mA DC power adapter.
- 7 HDMI output:** Connect to a local HDMI display device.
- 8 HDMI input:** Connect to a HDMI source device.

Operation controls and functions

Receiver

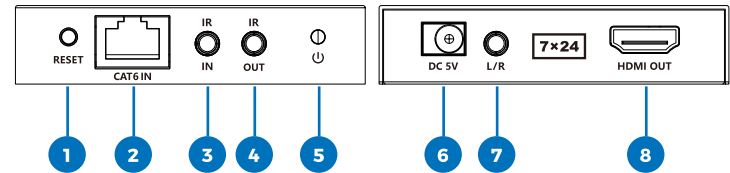

- 1 Reset button:** Press to restart the device.
- 2 RJ45 output:** Input modulated HDMI signal.
- 3 IR out:** Connect the IR receiver extension cable to ensure that the remote control used is within the range of the IR receiving device.
- 4 IR out:** Connect the IR blaster extension cable, please keep the infrared transmitter as close as possible to the signal source device when using.
- 5 Power/Signal indicator:**
 - When power is on and no HDMI signal is transmitted, the indicator flashes.
 - When power is on and HDMI signal is transmitted, the indicator is always on.
- 6 DC 5V input:** Connect to the 5V500mA DC power adapter.
- 7 3.5mm L/R out:** Connect headphones or power amplifiers to output stereo audio.
- 8 HDMI output:** Connect to a HDMI display device.

Operation controls and functions

Transmitter

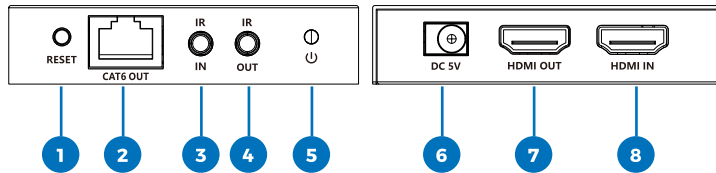

- 1 Reset button:** Press to restart the device.
- 2 RJ45 output:** Output modulated HDMI signal.
- 3 IR out:** Connect the IR receiver extension cable to ensure that the remote control used is within the range of the IR receiving device.
- 4 IR out:** Connect the IR blaster extension cable, please keep the infrared transmitter as close as possible to the signal source device when using.
- 5 Power/Signal indicator:**
 - When power is on and no HDMI signal is transmitted, the indicator flashes.
 - When power is on and HDMI signal is transmitted, the indicator is always on.
- 6 DC 5V input:** Connect to the 5V500mA DC power adapter.
- 7 HDMI output:** Connect to a local HDMI display device.
- 8 HDMI input:** Connect to a HDMI source device.

Operation controls and functions

Receiver

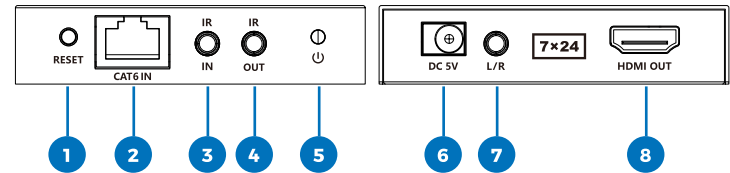

- 1 Reset button:** Press to restart the device.
- 2 RJ45 output:** Input modulated HDMI signal.
- 3 IR out:** Connect the IR receiver extension cable to ensure that the remote control used is within the range of the IR receiving device.
- 4 IR out:** Connect the IR blaster extension cable, please keep the infrared transmitter as close as possible to the signal source device when using.
- 5 Power/Signal indicator:**
 - When power is on and no HDMI signal is transmitted, the indicator flashes.
 - When power is on and HDMI signal is transmitted, the indicator is always on.
- 6 DC 5V input:** Connect to the 5V500mA DC power adapter.
- 7 3.5mm L/R out:** Connect headphones or power amplifiers to output stereo audio.
- 8 HDMI output:** Connect to a HDMI display device.

Connection Diagram

Description

Connection Diagrams

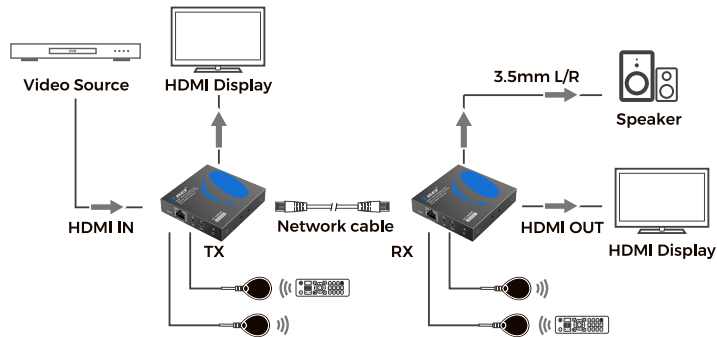

Connection Diagram

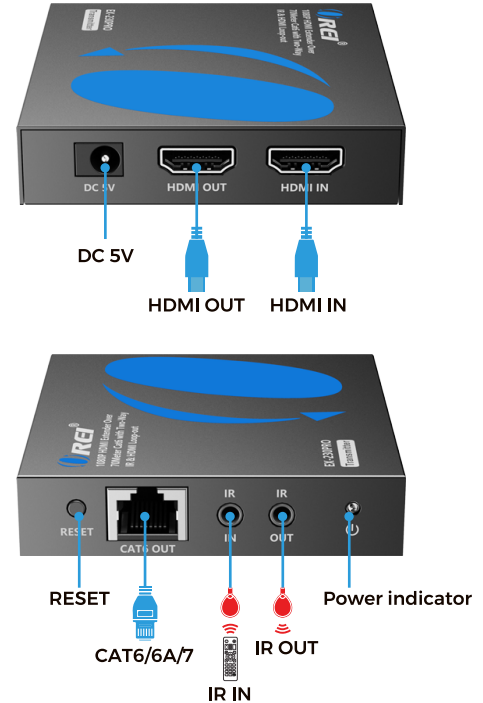

Connection Diagram

