

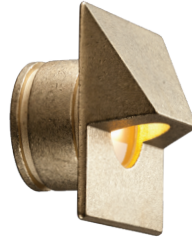

RD



SQ



ST



WW

PROJECT \_\_\_\_\_

CATALOG # \_\_\_\_\_

TYPE \_\_\_\_\_

NOTES \_\_\_\_\_

## MO Wall Light **DESIGNER PREMIUM**

Glare-free wall light can also function as an up light in 1 or 3 LED. Available in four brass faceplate options. An RGBW version is also available for use with Luxor® ZDC systems.

### Quick Facts

- Die-cast brass
- Natural, powder coated, or antiqued brass
- Cree® integrated LEDs
- Color temperature filters
- Compatible with Luxor technology
- Phase and PWM dimmable
- Input voltage: 10-15V

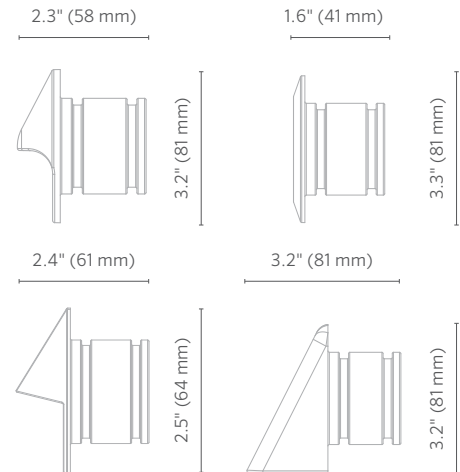

# MO Wall Light SPECIFICATIONS

Output	1LED	3LED	3LEDT	ZDC
Total Lumens <sup>†‡</sup>	13-68	33-169	21-102	61
Input Voltage	10 to 15V	10 to 15V	10 to 15V	11 to 15V
Input Power (W)	2.0	4.2	4.2	6.0
VA	2.4	4.5	4.5	7.2
Efficacy (Lumens/Watt)	18	21	29	19
Color Rendering Index (CRI)	82	82	--	82
Max Candela <sup>‡</sup>	31	79	195	51
Dimming	PWM, Phase**	PWM, Phase**	PWM, Phase**	--
RGBW Available	No	No	No	Yes
<b>Luxor Compatibility</b>				
Default	Zoning	Zoning	--	--
ZD Option	Zoning/Dimming	Zoning/Dimming	Zoning/Dimming	--
ZDC Option	--	--	--	Zoning/Dimming/Color
Minimum Rated Life (L70)	50,000 Hrs	50,000 Hrs	50,000 Hrs	50,000 Hrs
BUG Rating (RD & SQ)	B0-U1-G0	B0-U1-G1	B0-U1-G1	B0-U1-G0

<sup>†</sup> Measured using the 3,900K CCT lens. Multipliers for other CCTs include 0.80 (2,700K), 0.65 (4,500K), and 0.65 (5,200K).

<sup>‡</sup> Measured using the Round (RD) faceplate. Multipliers for other faceplates include: 1.0 (Square), 2.0 (spot), and 0.4 (Wall Wash).

\*\* For optimal performance, use a trailing-edge, phase-cut dimmer.

## FX Luminaire

FX Luminaire is an industry-leading manufacturer of landscape and architectural lighting products with a focus on the advancement of LED technology and digital lighting control with zoning, dimming, and color adjustment capabilities. We offer a full spectrum of highly efficient lighting fixtures that can be utilized to create elegant, cutting-edge landscape lighting systems for commercial or residential applications. Our products are available exclusively via our extensive professional distributor network.

## Materials

Die-cast C360 brass faceplate, A380 aluminum housing, ABS construction conduit sleeve.

## Socket

Socket contains MoistureBlock™ technology, preventing moisture from wicking up into sealed areas of the fixture.

## Warranty

10-year limited warranty.

## Lamp

Integrated module with Cree LEDs. Gold-plated connectors and conformal coated for maximum reliability and corrosion resistance. Proprietary on-board intelligent driver uses firmware-controlled temperature regulation, maximizing LED life. Field upgradeable and replaceable, the LEDs are rated to 50,000 hrs. Maximum drive current: 1 A.

## Optics

Polycarbonate color temperature adjustment lenses included with fixture: 2,700K (preinstalled), 3,900K (no lens), 4,500K, and 5,200K. Color temperature lenses field serviceable. Beam angle is calculated using LM-79 method for SSL luminaires.

## Wiring

18 AWG (1 mm); SPT-1W; 220°F (105°C); 300V; 10' (3 m) length.

## Faceplate

Die-cast brass faceplate.

## Power

Input 10-15VAC/VDC 50/60Hz. Remote transformer required (specify separately).

## Housing

Die-cast aluminum housing with capacity for 1LED, 3LED, or ZDC integrated LEDs.

## IES Classification

Type IV (RD & SQ), Type V (ST), Type II (WW).

## Lens

Tempered glass lens with shock resistance and high tolerance for thermal expansion and stress.

## Finish

Options of natural brass finish, antique finish with brushed (Antique Bronze) or tumbled (Antique Tumbled) effect, or TGIC powder coat finish. Antique finishes sealed with a clear TGIC powder coat layer.

## Ambient Operating Temperature

0°F to 140°F (-18°C to 60°C)

## Weight

3.6 lbs. (1.6 kg)

## Hardware

Includes 2" (51 mm) x 12" (305 mm) ABS conduit sleeve with ½"-14 (13 mm) NPT female hole for strain relief. Strain relief specified separately.

## Control

Luxor ZD or ZDC utilizes Luxor technology to zone light fixtures in up to 250 groups, dim each group in 1% increments between 0 and 100%, or change to one of 30,000 colors with RGBW LEDs. Select the ZD option for zoning/dimming or ZDC for zoning/dimming/color. Standard fixture is zoneable with Luxor.

## Sustainability

Innovation meets conservation in the design and manufacturing of our products. Where we can, we use recycled materials while maintaining superior functionality. Our LED products provide high-quality light at optimal energy efficiency, lifespan, and durability.

## Manufacturing

ISO 9001:2015 certified facility

## Wildlife-Friendly Lighting

When used with the 3LEDT Output option, this fixture is Wildlife Lighting Certified by the Florida Fish and Wildlife Conservation Commission.

## Installation Requirements

RD & SQ - Designed for recessed installation in a vertical wall in the down lighting position only.

WW - Designed for recessed installation in a vertical wall in any orientation.

ST - Designed for recessed installation in a vertical or horizontal wall; ensure substantial drainage flow for up lighting (e.g., decking).













## International Compliance

Compliant per IEC 60598-1 and IEC 60598-2-7 when used with International WallKit ("EKITWALL").

## Listings



# MO Wall Light ORDERING INFORMATION

Fixture	Luxor Option	Output	Faceplate	Finish	
MO*	■ [default] Zone	■ 1LED 60 Lumens	■ RD Round	■ BS Natural Brass	
	■ ZD Zone/Dim	■ 3LED 165 Lumens	■ SQ Square	■ BZ Bronze Metallic	
		■ 3LEDT** Wildlife-Friendly Amber (585-595 nm)	■ ST Spot	■ DG Desert Granite	
	■ ZDC Zone/Dim/Color	■ [default] 90 Lumens	■ WW Wall Wash	■ WI Weathered Iron	
				■ SB Sedona Brown	
				■ FB Black	
				■ WG White Gloss	
				■ FW Flat White	
				■ AL Almond	
				■ SV Silver	
			■ NP Nickel Plate		
			■ AB Antique Bronze		
			■ AT Antique Tumbled		

EXAMPLE FIXTURE CONFIGURATION:

MO-ZDC-RD-SV

\*Includes 2.0" (51 mm) conduit sleeve (250020600000)

\*\* Available with ZD Luxor option and CU, AB, or AT finishes only



## ACCESSORIES: Specify Separately

Accessories	Code
■ PO MOUNTING BRACKET	POBRKT
■ STANDARD OPTICS KIT	ΔLEDOPTICKIT

# MO Wall Light PHOTOMETRICS

MO 1LED Illuminance at a Distance		RD/SQ	
Feet (Meters)	Center Beam	Beam Width	
	Foot-candle (Lux)	Vertical 45°	Horizontal 75°
0.5' (0.2 m)	16 fc (174 lx)	0.4' (0.1 m)	0.7' (0.2 m)
1.0' (0.3 m)	4 fc (43 lx)	0.8' (0.2 m)	1.5' (0.5 m)
1.5' (0.5 m)	1.8 fc (19 lx)	1.2' (0.4 m)	2.2' (0.7 m)
2.0' (0.6 m)	1.0 fc (11 lx)	1.6' (0.5 m)	3' (0.9 m)
2.5' (0.8 m)	0.6 fc (7 lx)	2' (0.6 m)	4' (1 m)

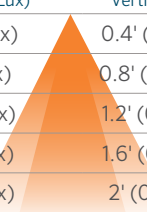

MO 1LED Illuminance at a Distance		ST	
Feet (Meters)	Center Beam	Beam Width	
	Foot-candle (Lux)	Vertical 90°	
0.5' (0.2 m)	136 fc (1,467 lx)	1' (0.3 m)	
1.0' (0.3 m)	34 fc (366 lx)	2' (0.6 m)	
1.5' (0.5 m)	15 fc (162 lx)	3' (0.9 m)	
2.0' (0.6 m)	9 fc (97 lx)	4' (1.2 m)	
2.5' (0.8 m)	4 fc (43 lx)	5' (1.5 m)	

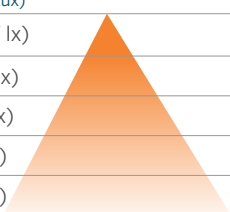

MO 1LED Illuminance at a Distance		WW	
Feet (Meters)	Center Beam	Beam Width	
	Foot-candle (Lux)	Vertical 50°	Horizontal 60°
0.5' (0.2 m)	33 fc (355 lx)	0.5' (0.2 m)	0.7' (0.2 m)
1.0' (0.3 m)	8 fc (86 lx)	1' (0.3 m)	1.3' (0.4 m)
1.5' (0.5 m)	4 fc (43 lx)	1.5' (0.5 m)	2.0' (0.6 m)
2.0' (0.6 m)	2 fc (22 lx)	2.0' (0.6 m)	2.6' (0.8 m)
2.5' (0.8 m)	1.3 fc (14 lx)	2.4' (0.7 m)	3.3' (1 m)

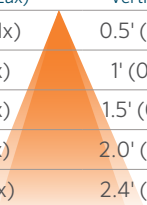

MO 3LED Illuminance at a Distance		RD/SQ	
Feet (Meters)	Center Beam	Beam Width	
	Foot-candle (Lux)	Vertical 40°	Horizontal 60°
0.5' (0.2 m)	33 fc (355 lx)	0.4' (0.1 m)	0.6' (0.2 m)
1.0' (0.3 m)	8 fc (86 lx)	0.8' (0.2 m)	1' (0.4 m)
1.5' (0.5 m)	4 fc (43 lx)	1' (0.4 m)	2' (0.6 m)
2.0' (0.6 m)	2 fc (22 lx)	2' (0.5 m)	3' (0.8 m)
2.5' (0.8 m)	1.3 fc (14 lx)	2' (0.6 m)	3' (0.8 m)

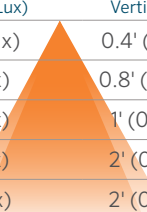

MO 3LED Illuminance at a Distance		ST	
Feet (Meters)	Center Beam	Beam Width	
	Foot-candle (Lux)	Vertical 85°	
0.5' (0.2 m)	355 fc (3,821 lx)	1' (0.4 m)	
1.0' (0.3 m)	89 fc (958 lx)	2' (0.5 m)	
1.5' (0.5 m)	39 fc (424 lx)	3' (0.9 m)	
2.0' (0.6 m)	22 fc (239 lx)	4' (1.2 m)	
2.5' (0.8 m)	14 fc (153 lx)	5' (1.5 m)	

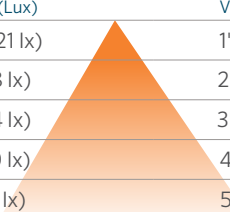

MO 3LED Illuminance at a Distance		WW	
Feet (Meters)	Center Beam	Beam Width	
	Foot-candle (Lux)	Vertical 50°	Horizontal 70°
0.5' (0.2 m)	88 fc (946 lx)	0.5' (0.2 m)	0.7' (0.2 m)
1.0' (0.3 m)	22 fc (237 lx)	1' (0.3 m)	1.3' (0.4 m)
1.5' (0.5 m)	10 fc (106 lx)	1.5' (0.5 m)	2.0' (0.6 m)
2.0' (0.6 m)	6 fc (59 lx)	2' (0.6 m)	2.5' (0.8 m)
2.5' (0.8 m)	4 fc (38 lx)	3' (0.9 m)	3' (0.8 m)

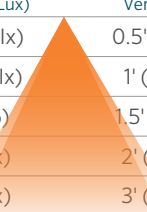

# MO Wall Light PHOTOMETRICS

MO zDC Illuminance at a Distance		RD/SQ	
Feet (Meters)	Center Beam	Beam Width	
	Foot-candle (Lux)	Vertical 45°	Horizontal 70°
0.5' (0.2 m)	24 fc (262 lx)	0.4' (0.1 m)	0.7' (0.2 m)
1.0' (0.3 m)	61 fc (655 lx)	0.8' (0.2 m)	1' (0.4 m)
1.5' (0.5 m)	2.7 fc (29 lx)	1.2' (0.4 m)	2' (0.6 m)
2.0' (0.6 m)	1.5 fc (16 lx)	1.6' (0.5 m)	3' (0.9 m)
2.5' (0.8 m)	0.97 fc (10 lx)	2' (0.6 m)	3' (0.9 m)

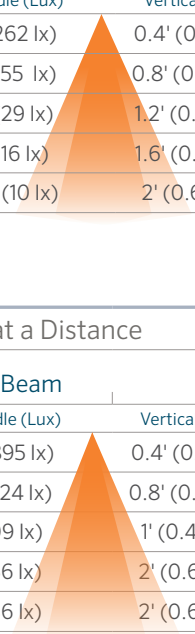

MO zDC Illuminance at a Distance		ST	
Feet (Meters)	Center Beam	Beam Width	
	Foot-candle/Lux	Vertical 90°	
0.5' (0.2 m)	268 fc (2,885 lx)	1' (0.4 m)	
1.0' (0.3 m)	67 fc (721 lx)	2' (0.6 m)	
1.5' (0.5 m)	30 fc (321 lx)	3' (0.9 m)	
2.0' (0.6 m)	17 fc (181 lx)	4' (1.2 m)	
2.5' (0.8 m)	11 fc (115 lx)	5' (1.5 m)	

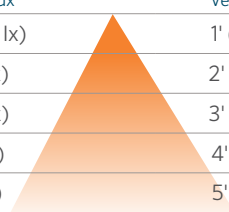

MO zDC Illuminance at a Distance		WW	
Feet (Meters)	Center Beam	Beam Width	
	Foot-candle (Lux)	Vertical 40°	Horizontal 70°
0.5' (0.2 m)	83 fc (895 lx)	0.4' (0.1 m)	0.7' (0.2 m)
1.0' (0.3 m)	21 fc (224 lx)	0.8' (0.2 m)	1' (0.4 m)
1.5' (0.5 m)	9 fc (99 lx)	1' (0.4 m)	2' (0.6 m)
2.0' (0.6 m)	5 fc (56 lx)	2' (0.6 m)	3' (0.9 m)
2.5' (0.8 m)	3 fc (36 lx)	2' (0.6 m)	4' (1 m)

