

# DX CONTROLLER

LED Landscape  
Lighting Transformer

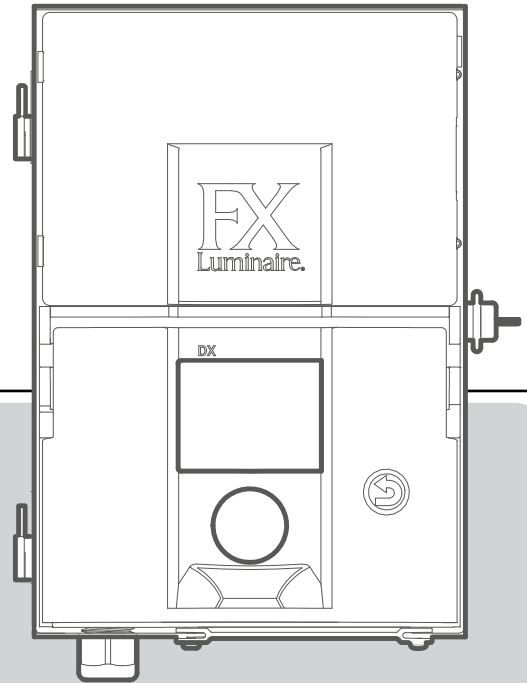

Owner's Manual and Installation Instructions  
for DX Controller

FXLuminaire®

# TABLE OF CONTENTS

---

<b>DX Controller Overview .....</b>	<b>3</b>	<b>Installing Multiple Transformers .....</b>	<b>17</b>
Controller Components.....	3	Controlling A Transformer	
Facepack Components .....	3	Via An External Source .....	17
<b>Safety Information .....</b>	<b>4</b>	<b>Care and Maintenance.....</b>	<b>18</b>
<b>Installing the DX Controller .....</b>	<b>5</b>	Regular Preventive Maintenance .....	18
Placing the Transformer(s) .....	5	<b>Warranty .....</b>	<b>19</b>
Mounting the Transformer(s) .....	5		
Running Cable to the Fixtures .....	6		
Summary .....	7		
Cable Stats.....	7		
<b>Operating the DX Controller .....</b>	<b>8</b>		
Navigating the DX.....	8		
Home Screen .....	8		
Setup Screen .....	9		
Time/Date .....	9		
Language .....	9		
Location .....	10		
Backup .....	11		
Disable .....	11		
Firmware.....	12		
Manual.....	14		
Programs .....	15		
Activity.....	16		

# DX CONTROLLER OVERVIEW

---

## CONTROLLER COMPONENTS

1. Transformer Cover
2. Facepack Connection
3. Output Terminals
4. Primary Voltage Cover
5. External Input Terminal Block

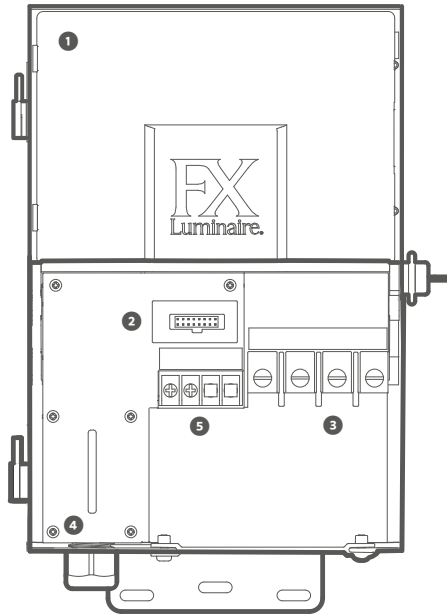

## FACEPACK COMPONENTS

1. LCD Screen
2. Back Button
3. Clickable Scroll Wheel

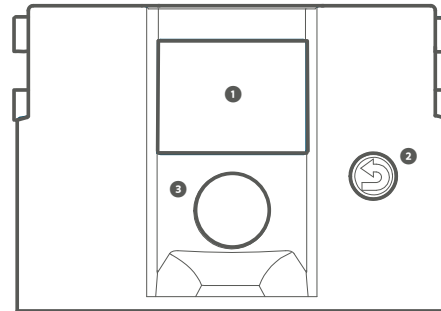

# SAFETY INFORMATION

---

These cord-connected units consist of step-down, isolated, two-winding-type transformers, circuit breakers, and associated circuitry intended to supply power to low-voltage and submersible fountain lighting fixtures.

**WARNING — Risk of Electric Shock:** Install the power unit 5 feet or more from a pool or spa and 10 feet or more from a fountain. Where the power unit is installed within 10 feet of a pool or spa, connect the power unit to a GFCI-protected branch circuit. Do not use an extension cord when connecting the power unit to the 120V source. The grounding conductor shall be 12 AWG minimum. Outdoor power unit shall be connected to a GFCI-protected hooded flush type cover plate receptacle marked “Wet Location” while in use.

**Caution:** The supply circuit for the landscape lighting system shall be protected by a Class A-type ground fault circuit interrupter, unless it is provided with the landscape lighting system. This device is accepted as a component of a landscape lighting system where the suitability of the combination shall be determined by local inspection authorities having jurisdiction. Do not connect two or more power supplies in parallel. Not for use in dwelling units. This presents a risk of fire. Do not place insulation under terminal plate. Check connector after installation.

**Circuit Protection:**

150-watt power controller: 12.5 amps

300-watt power controller: 25 amps

# INSTALLING THE DX CONTROLLER

## STEP 1

### PLACING THE TRANSFORMER(S)

1. Place transformer(s) in a well-ventilated area away from direct irrigation spray and central to the proposed installation site of the majority of the lighting fixtures. The primary goal is to minimize the length of cable runs from your transformer(s) to the lighting fixtures, which minimizes voltage drop and cable size. A common mistake is to locate the single transformer on the service side of the house or in the garage, which might result in excessively long cable runs to reach lighted areas.
2. Transformer(s) with power cords must be located adjacent to a 120-volt, GFCI-protected exterior electrical receptacle. If a 120-volt power source is not available at the desired transformer installation location, we recommend that you hire a licensed electrician to run a dedicated 120-volt, 15-amp circuit to the desired location.
3. Test all existing receptacles with both a receptacle tester and a digital voltmeter or amp clamp to verify proper wiring and voltage at the receptacle.

## STEP 2

### MOUNTING THE TRANSFORMER(S)

#### Wall-Mount Installation:

1. Install all transformers a minimum of 12" above the finish grade (as measured from the finish grade to the bottom of the transformer) and according to code.
2. Drill pilot holes into the mounting surface, insert anchors, and install screws into the anchors, leaving approximately 1/8" of thread exposed. Mount the transformer.
3. Use a level and a pencil to determine and mark locations for the bottom anchors. Remove the transformer from the wall. Drill bottom anchor holes and install the anchors.
4. Place the transformer back on top of the uppermost mounting screw and install screws into the anchors at the bottom of the transformer to secure it to the wall.

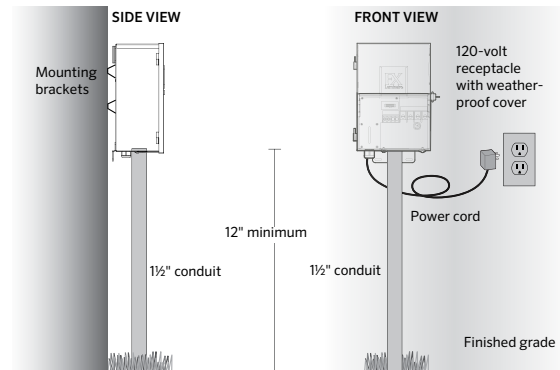

# INSTALLING THE DX CONTROLLER

**Post-Mount Installation:** Install a pressure-treated 4" x 4" x 36" (min) post in concrete footing. Follow wall-mount installation instructions from page 5, without the use of wall anchors.

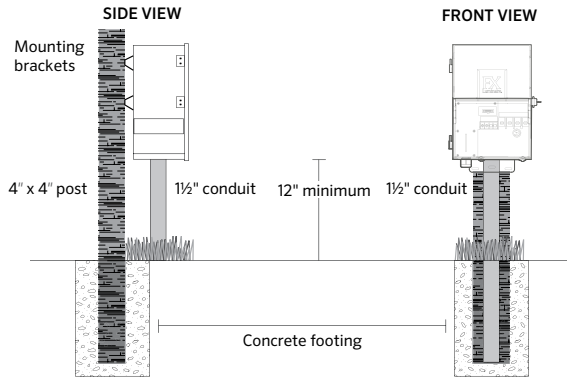

For additional information regarding installation techniques, visit [fxl.com](http://fxl.com) and click on the Professionals tab.

All transformers come equipped with a 5-foot, 12-gauge, 3-prong electrical power cord. Only use the power cord in conjunction with a GFCI-protected, 120-volt exterior receptacle.

## STEP 3

### RUNNING CABLE TO THE FIXTURES

Once the transformer has been installed and all fixture locations have been determined, the next step is to run a correctly sized cable from the transformer to the fixtures. FX Luminaire LED fixtures require between 10 and 15 volts for optimal operation and longevity. This is accomplished by the following:

1. Group fixtures into distance zones as illustrated on the following page. Do not place a fixture that is 10 feet away from the transformer on the same cable run as one that is 100 feet away.
2. Use the proper cabling method for the application. To minimize the voltage differential between fixtures, center-load all cable runs when possible.
3. Use a correctly sized cable to accommodate voltage drop. As a general rule of thumb, limit the wattage load per cable run to no more than 160 watts.

# INSTALLING THE DX CONTROLLER

## SUMMARY

For maximum light output and LED life, each luminaire should be provided with between 10 to 15 volts.

## CABLE STATS

Low-voltage lighting systems are typically installed using direct-burial-rated stranded cable. The most common cable used is referred to as 12/2 stranded cable. The size of cable used in wiring the lighting system is determined by the wattage load and length of cable run from the transformer to the lighting fixtures. It is very important to note that all low-voltage cable has a maximum rating. Overloading cable can create a dangerous safety hazard, so be sure to choose the proper cable for your lighting system.

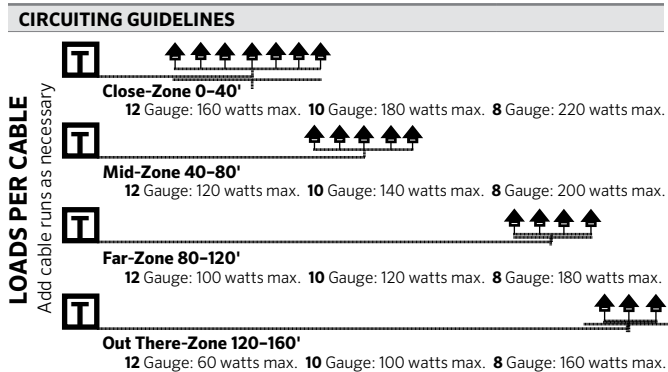

# OPERATING THE DX CONTROLLER

---

## NAVIGATING THE DX

The DX controller contains two user interface elements:

- The clickable scroll wheel is the primary navigation and selection element.
- The **BACK** button navigates to the previous screen.

## HOME SCREEN

All DX controller functions are accessible through the **HOME** screen. The default display on the **HOME** screen includes the following:

- Current time
- Current date
- Sunrise/sunset time for the current day
- Menu options (PROGRAMS, SETUP, MANUAL)

All menu options are placed on the right-hand side of the **HOME** screen and can be selected by using the scroll wheel. Turn the scroll wheel clockwise or counterclockwise until the desired menu option is highlighted in blue. Press the scroll wheel down to select and enter the desired option.

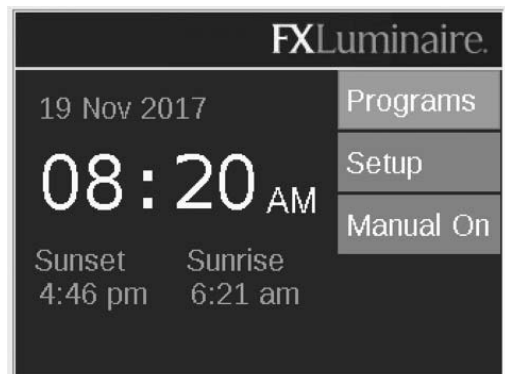
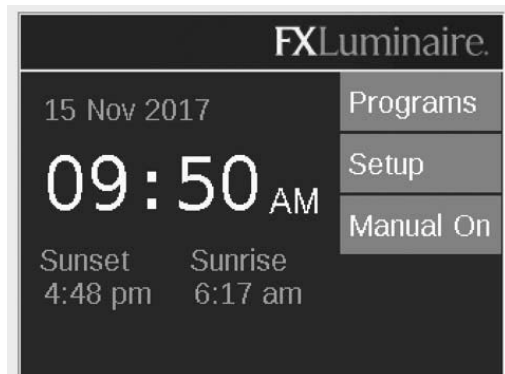



# OPERATING THE DX CONTROLLER

## SETUP SCREEN

All background tools and settings are accessible in the **SETUP** screen. Scroll through the various options to configure the controller.

## TIME/DATE

- Set the three date categories (Month, Day, Year) to the current date by pushing the scroll wheel when the appropriate field is highlighted, scrolling through the options, and pressing the scroll wheel again to finalize the selection.
- Setting the month, day, and year automatically sets the day of the week, which appears to the right of the year.
- Set the three time categories (Hr:Min:Sec) to the current time settings by pushing the scroll wheel when the appropriate field is highlighted, scrolling through the numeric options, and pressing the scroll wheel again to finalize the selection.
- Turn past 12 on the hour (“Hr”) setting to adjust a.m. and p.m., as displayed next to the seconds (“Sec”).
- To convert the clock to 24-hour convention, select the “24hr” selection box.
- Daylight Saving Time (DST), when activated, will adjust time forward or backward by one hour on the relevant dates each year. To initiate it, select **ON**. To deactivate it, select **OFF**.

## LANGUAGE

In the **SETUP** screen, select the language field by pressing the scroll wheel and turning it to the desired language. Press the scroll wheel again to finalize the selection.

- The language change will not take effect until the **BACK** button is pressed.

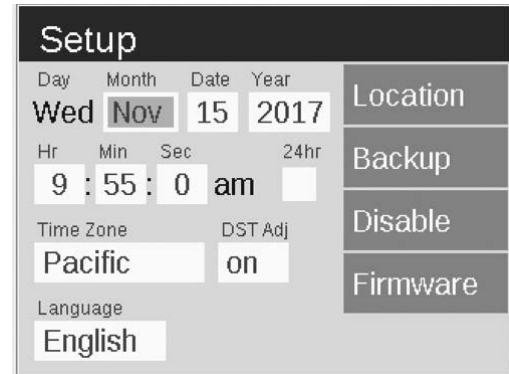

# OPERATING THE DX CONTROLLER

## LOCATION

The **LOCATION** menu is designed to graphically represent a DX controller's location on a map for accurate sunrise and sunset times based on the current date, time zone, and longitude/latitude settings. First, set the time zone in the **SETUP** screen. While in the **SETUP** screen, enter the **LOCATION** screen to adjust longitude and latitude coordinates.

- The full-screen crosshairs designate the user's location on the map.
- Latitude is first adjusted by rotating the scroll wheel to move the crosshairs up and down. Numeric indicators at the top right display the actual coordinate. Press the scroll wheel to select the latitude; set it by pressing the click-wheel.
- Longitude is adjusted by rotating the scroll wheel to move the crosshairs left and right.
- The coordinates are automatically saved after each press of the scroll wheel. Select the **BACK** button to leave the **LOCATION** screen.
- Reset or adjustment is initiated by pressing the scroll wheel and then repeating the above latitude and longitude steps.

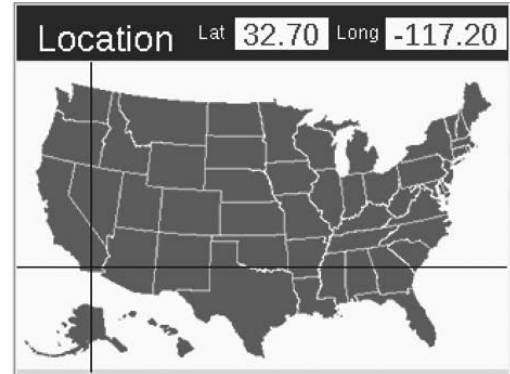

# OPERATING THE DX CONTROLLER

---

## **BACKUP**

The **BACKUP** function saves all user input information, including programs and setup data. To create a backup file for your DX controller, follow the steps below:

1. Remove the plastic cover from the side of the DX facepack and insert an SD card with the pins facing the front of the facepack. Press the card completely inward and then release. The card will lock into place.
2. From the **HOME** screen, navigate to the **SETUP** screen and then the **BACKUP** screen using the scroll wheel.
3. Input a file name for the backup file. You do not need to use all available spaces.
4. Press **BACKUP**.
5. After backup is successful, press the SD card inward and then release to remove the card from the facepack. Replace the cover to the facepack.

### **To restore an existing file, follow the steps below:**

1. Remove the plastic cover from the side of the DX facepack and insert an SD card (pins facing the front) with the pre-loaded file. Press the card completely inward and then release. The card will lock into place.
2. From the **HOME** screen, navigate to the **SETUP** screen and then the **BACKUP** screen using the scroll wheel.
3. Input the file name of the desired database to restore. The filename must match exactly.

4. Press **RESTORE**.

5. After a successful restore, press the SD card inward and then release to remove the card from the facepack. Replace the cover to the facepack.

## **DISABLE**

The **DISABLE** option completely shuts down all lighting events in the **MANUAL** and **PROGRAM** modes regardless of time or status, indefinitely. This mode does not turn off the unit, but rather suspends all lighting events until the user decides to reactivate. The lights will remain off after a reactivation is executed and will not turn back on until the next event (program or manual) occurs.

1. **DISABLE** is accessed from the **SETUP** screen.
2. When **DISABLE** is initiated via pressing the scroll wheel, the unit will immediately shut down all fixtures in **PROGRAMS** or **MANUAL**.
3. While **DISABLE** is initiated, all lights will remain off. The lights will not reactivate until **ENABLE** is selected.
4. The **HOME** screen will show **OFF** in place of the current time when the unit is **DISABLED**.

# OPERATING THE DX CONTROLLER

---

## FIRMWARE

Firmware updates are occasionally released for the DX to add features or enhance functionality. To update the facepack or flash firmware on the DX, an SD card is required to transfer the data from a computer to the facepack.

1. Go to the FX Luminaire website ([fxl.com](http://fxl.com)) and navigate to the DX product page. The firmware update files are located under the **RESOURCES** tab.
2. Save the desired firmware onto an SD card.
3. Pull up on facepack and remove the SD card slot cover by sliding the cover upward.
4. Insert the SD card with the pins facing the front of the facepack. Press it completely inward and then release to lock the card into place.

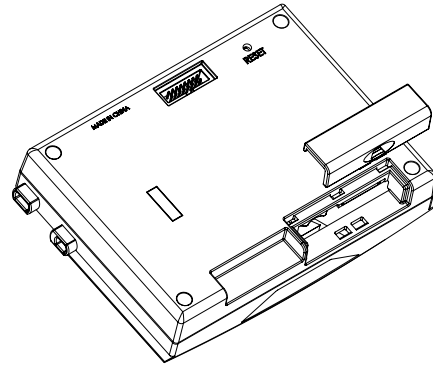

# OPERATING THE DX CONTROLLER

- From the **HOME** screen, select **SETUP**.
- Scroll to **FIRMWARE** and press the scroll wheel. The firmware load screen will appear.

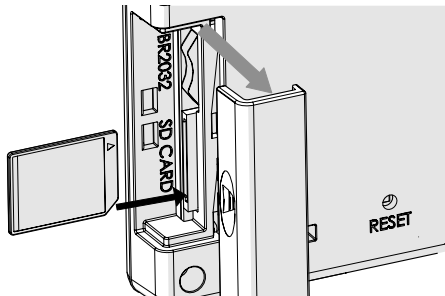

- Navigate to the desired update type and press the scroll wheel to select. The facepack and flash update processes usually take no longer than 15 seconds.

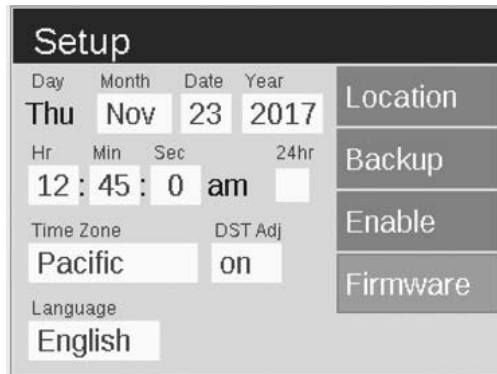

# OPERATING THE DX CONTROLLER

## MANUAL

The manual mode is used to turn on lights outside of set programs. Manual settings take precedence over any currently running or future programs if overlapped with the event time.

1. From the **HOME** screen, navigate to the **MANUAL** screen using the scroll wheel.

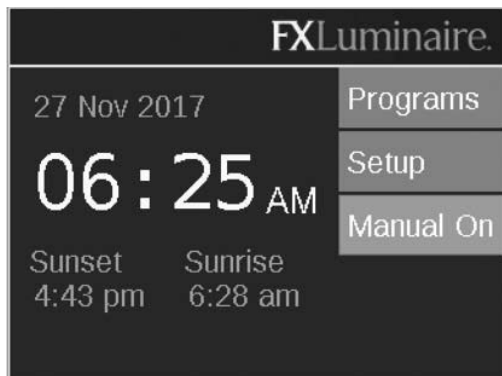

2. Select **MANUAL ON** to turn on the transformer. The initial run time is set to one hour. If additional run time is needed, select the duration field and increase the time by turning the scroll wheel to the right.
3. Lights will remain on for the duration of manual operation (until **MANUAL OFF** is selected from the **HOME** screen or **STOP** is selected from the **MANUAL** screen).

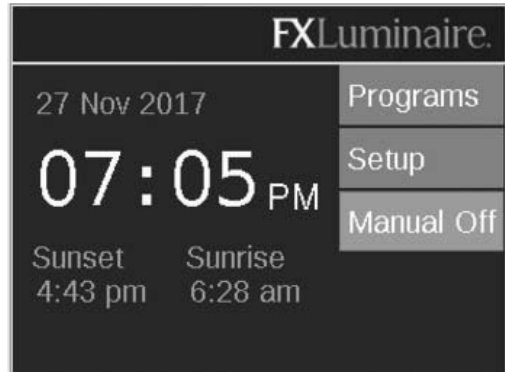
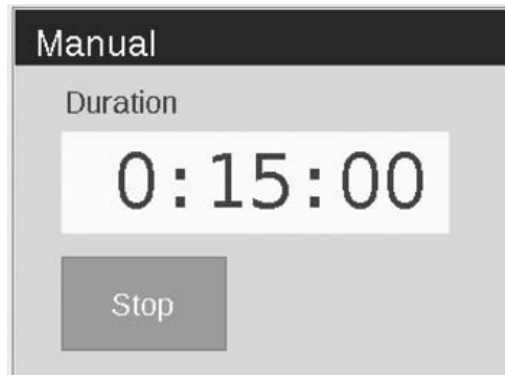

# OPERATING THE DX CONTROLLER

## PROGRAMS

The **PROGRAMS** screen is where all daily running programs are configured.

- Each program is designated by a letter (“A” through “G”) at the top right section of the screen. Select the desired letter using the scroll wheel prior to selecting the days of the week.
- Selecting days of the week designates which days the program will run based on the event settings. Select or remove each day by highlighting the corresponding box over each day with the scroll wheel and pushing to select or deselect.
- The event field specifies the event time a specific action will occur. Every event must have an initiation time.
- Four events can be created for each scheduled program.
- In addition to a fixed time setting for an event, a sunrise or sunset setting is available for each event. This is based on astronomical timing determined by the set location of the unit. The unit must have a location setting under **SETUP** to accurately adjust at the actual sunrise or sunset times.
- Time offsets can be used for sunrise/sunset events. Offsets can be either positive (+) or negative (-), and will adjust in 15-minute increments.
- The ON/OFF field determines the action that will occur during the scheduled event.

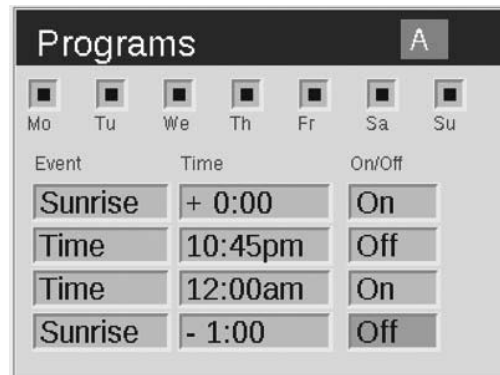
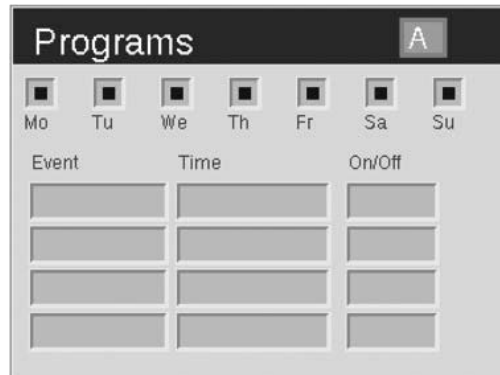

# OPERATING THE DX CONTROLLER

---

## ACTIVITY

After five minutes of inactivity, an **ACTIVITY** screen will appear on the LCD screen if the transformer is under load. The inactivity wait time decreases to five seconds when the current screen is the **HOME** screen. The **ACTIVITY** screen displays:

1. Menu options - All options are selectable from the **ACTIVITY** screen
2. **TIME** - Current time
3. **SOURCE** - Source of Activity (i.e., Manual operation or Scheduled operation)
4. **LOAD** - System load displayed as a percentage

The **HOME** screen is accessible by pressing the **BACK** button on the facepack.

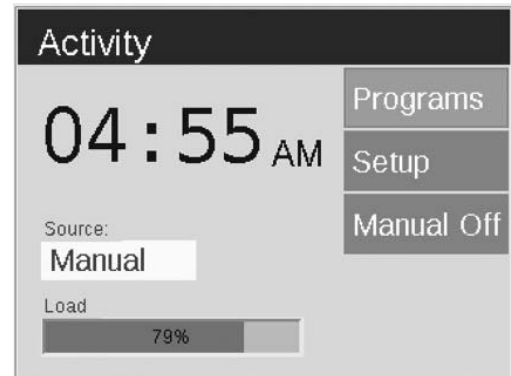



# INSTALLING MULTIPLE TRANSFORMERS

## CONTROLLING A TRANSFORMER VIA AN EXTERNAL SOURCE

The DX Transformer can be controlled from another transformer via the 12–24 volt **EXTERNAL** connection.

Operate multiple transformers from a single source:

1. If you have multiple transformers on a single site, a **PRIMARY** transformer can be designated to trigger them all.
2. Select **PRIMARY** controller and ensure that the **POWER IS OFF**.
3. Run a wire from the common terminal and one of the three voltage taps (12V, 13V, 14V) from the **PRIMARY TRANSFORMER**.
4. Connect this from **PRIMARY TRANSFORMER** into the secondary controller via the **EXT** (external) input.
5. At the **SECONDARY TRANSFORMER**, be sure to set the **ON TIME** to “**NONE**” so that the unit only comes on due to the **EXT** input.

1. The **SECONDARY TRANSFORMER** is now ready to receive input from the **PRIMARY TRANSFORMER**.
2. To confirm connection, reestablish power to both **PRIMARY** and **SECONDARY** transformers.
3. Activate lights via the **PRIMARY TRANSFORMER**.
4. A positive connection can be confirmed by the **EXT** light on the facepack of the **SECONDARY TRANSFORMER(S)** turning green.

The **PRIMARY** controls all lighting functions via its timing and/or control functions.

The **SECONDARY** initiates when the **PRIMARY** starts its lighting function.

There is no limit to the number of **SECONDARY** transformers that can be connected to a **PRIMARY** transformer, as long as each **SECONDARY** transformer receives between 12–24 volts.

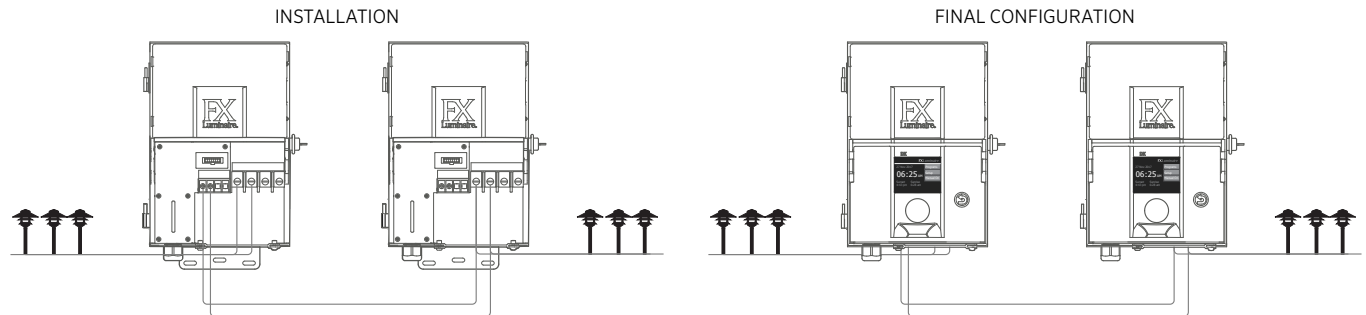

# CARE AND MAINTENANCE

---

## REGULAR PREVENTIVE MAINTENANCE

Perform the following regular preventive maintenance procedures:

Category	Description	Timeline
Transformer	Tighten all terminal lugs.	Annually
	Remove all bugs and webs.	Annually
Fixtures	Clean dirty lenses to minimize calcium deposits.	Annually
	Straighten all pathway lights.	Quarterly
	Trim all plants as needed; relocate fixtures as needed as plants mature.	Quarterly
	Clean debris off well light lenses and grates.	Quarterly
	Check cable and cable connectors.	Annually
	Rebury cable and connectors that may have risen to the surface.	Semi-annually
	Check aiming angles.	Semi-annually
	Check, adjust, and replace all cable and cable ties in trees.	As needed



**IMPORTANT: When replacing LED boards, be sure to replace with FX Luminaire LED boards. Use of other brands may cause the unit to malfunction.**

# WARRANTY

---

Hunter Industries Incorporated (“Hunter”) warrants FX Luminaire (“FX”) Transformers to be free of defects in materials or workmanship under normal use for a period of ten (10) years from the original date of installation. Hunter warrants FX Low-Voltage Lighting Fixtures to be free of defects in materials or workmanship under normal use for a period of three (3) years from the original date of installation. Hunter extends the warranty on FX Fixtures to ten (10) years from the original date of installation when both FX Fixtures and Transformers are installed on the same project exclusive of any competitor’s product. Hunter warrants FX LED Fixtures to be free of defects in materials or workmanship under normal use for a period of ten (10) years from the original date of installation. If a defect in an FX product is discovered during the applicable warranty period, Hunter will repair or replace, at its option, the product or the defective part. This warranty does not extend to repairs, adjustments, or replacement of an FX product or part that results from misuse, negligence, alteration, modification, tampering, or improper installation and/or maintenance of the product. This warranty extends only to the original installer of the FX product. If a defect arises in an FX product or part during the warranty period, you should contact your local FX Authorized Distributor.

FX LUMINAIRE’S OBLIGATION TO REPAIR OR REPLACE ITS PRODUCTS AS SET FORTH ABOVE IS THE SOLE AND EXCLUSIVE WARRANTY SET FORTH BY FX. THERE ARE NO OTHER WARRANTIES, EXPRESSED OR IMPLIED, INCLUDING WARRANTIES OF MERCHANTABILITY AND FITNESS FOR A PARTICULAR PURPOSE. FX WILL NOT BE LIABLE TO A DISTRIBUTOR OR ANY OTHER PARTY IN STRICT LIABILITY, TORT, CONTRACT, OR ANY OTHER MANNER FOR DAMAGES CAUSED OR CLAIMED TO BE CAUSED AS A RESULT OF ANY DESIGN OR DEFECT IN FX LUMINAIRE’S PRODUCTS, OR FOR ANY SPECIAL, INCIDENTAL, CONSEQUENTIAL, OR EXEMPLARY DAMAGES OF ANY NATURE, INCLUDING WITHOUT LIMITATION LOST BUSINESS OR PROFITS. NOTWITHSTANDING THE FOREGOING, IF FOR ANY REASON FX IS FOUND TO BE LIABLE IN NO EVENT SHALL FX’S LIABILITY EXCEED THE PRICE OF THE PRODUCT WHICH GIVES RISE TO THE CLAIM, LOSS, OR DAMAGE.

**Any FX Luminaire product being returned must receive a Return Goods Authorization number from Hunter Customer Service prior to returning the product.** All returned products are subject to a 25-percent restocking fee. Products must be returned within six (6) months of order date. All products returned must be in their original packaging, be undamaged and unused and never energized. Products not meeting these criteria will be returned to the original sender. Hunter Industries is not responsible for product loss or damage incurred during the return transit to the RMA location.

If you have questions concerning the warranty or its application, please write to: Customer Service Department, FX Luminaire, 1940 Diamond Street, San Marcos, CA 92078, USA.

# NOTES

---

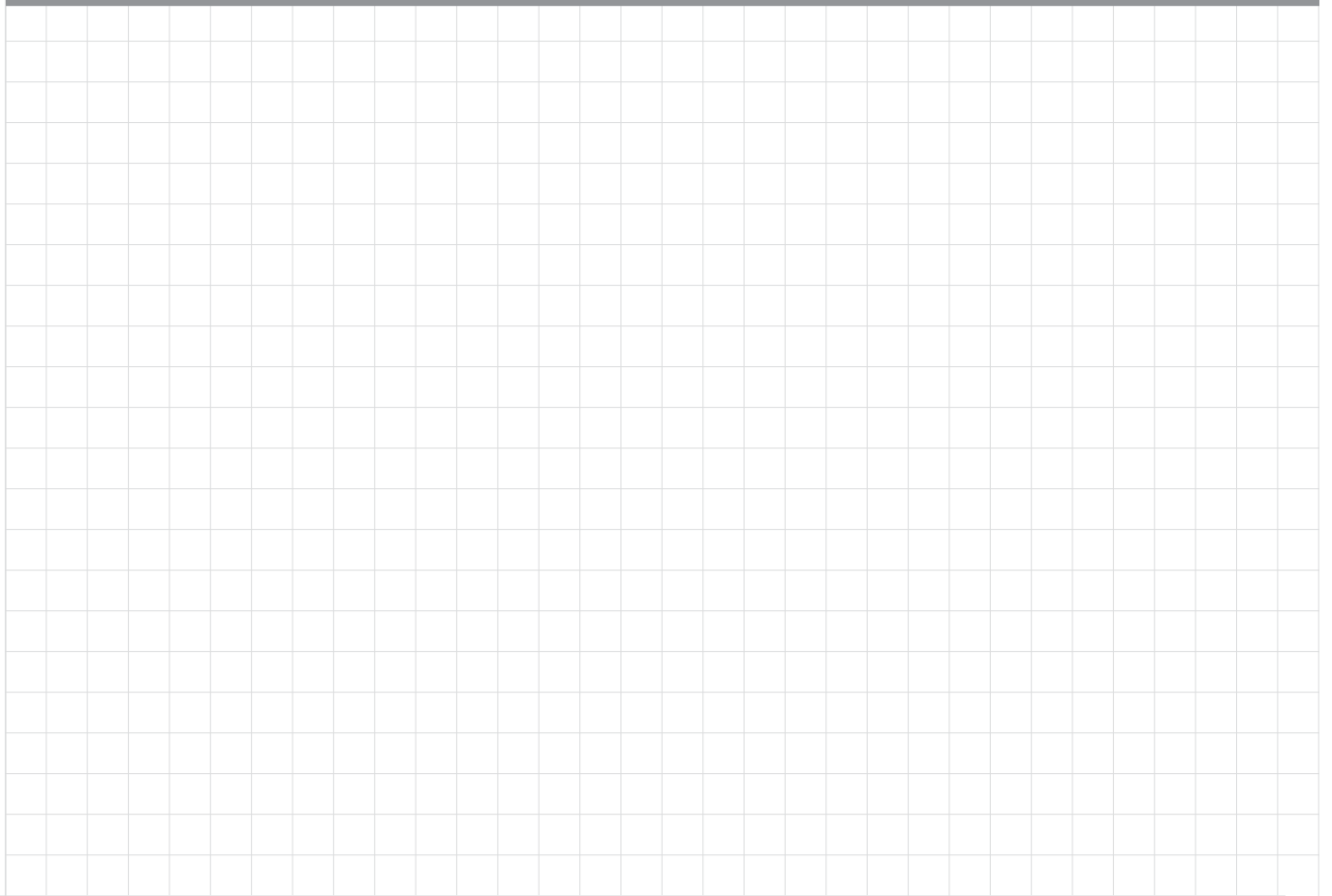

Find helpful information about your product, including tips on installation, controller programming, and more.



 [fxl.com](https://fxl.com)

 1-800-733-2823

---

**LANDSCAPE & ARCHITECTURAL LIGHTING**

1940 Diamond Street, San Marcos, California 92078, USA

[fxl.com](https://fxl.com)