

# Hunter®

 **Hydrawise™ Ready**  
IRRIGATION CONTROLLERS

---

## Hydrawise Software/App Owner's Manual



[hydrawise.com](http://hydrawise.com)

## Table of Contents

Table of Contents	2
Controller - Navigating Screens	5
Wireless - Connection Status Messages	6
Controller - Viewing Controller Status	7
Server Status	8
Success	9
Offline	10
Saving Settings	10
Serial Number	11
Controller - Viewing Network Information / Testing Internet Connectivity	11
Controller - Viewing Time and Date	12
Controller - Installing and Wiring	13
Controller - Function Paths	13
Controller - Manual Operation	15
Running a zone manually from the controller	15
Controller - Factory Default	16
Controller - Serial Number Location	18
Account - System Shut Off (Winterization)	19
Account - Location	22
Account - Language	25
Account - Controller Status	26
Account - Linking Controller	27
Account - Adding a Controller	28
Account - Zones and Schedules	32
Account - Run Length and Frequency	40
Account - Watering Start Times And Water Days	42
Account - Controller Weather Stations	46
Account - Water Triggers	49
Smart (ET) Watering	51
Account - Running Zone(s) Manually	54
Manual Single Station	54
Accounts - Reports	56
Account - Alerts	60
Assigning the Alert	60
Understanding Alerts:	63
Account - Controller Configuration	65
Account - Account Details	69
Account - Changing Current Controller	73
Account - Assigning/Removing Images on PC	74
Assigning New Image	74
Removing Image	75
Account - Assigning Images on Mobile	76
Account - Delete Controller	80
Account - Watering Type - Time Based	84
Account - Watering Type - Smart (ET) Watering	86

Account - Watering Type - Virtual Solar Sync	89
Account - Virtual Weather Station	92
Alerts - Auto suspend for high flow	94
Account - Units of Measurement	96
Account - Adding a Contractor	98
Account - Cycle/Soak Operation	100
Account - Account Name Edit	101
Account - Rename Controller	102
Account - Add User/Files	104
Add User	104
Account - Setting Delay	107
Account - Exporting Reports	109
Account - Editing Serial Number	110
Account - Resetting Password	113
Account - Not Receiving Hydrowise Activation Emails	114
Configuring - Several Watering Lengths One Zone	115
Configuring - Pre-configured Schedules	117
Configuring - Trigger "Water More Often When Hot"	120
Configuring - Trigger "Water Longer When Hot"	125
Setting Trigger	126
Smart Watering - Quick Reference	128
Smart Watering - Adjustment and Changes	129
Offline Mode - Accessing Offline Mode	133
Offline Mode - Run the Setup Wizard	136
Offline Mode - Sensors	138
Offline Mode - Seasonal Adjust	140
Account - API Information	143
Smart Voice Device - Amazon Alexa	143
Home Automation - Control4	147
HPC - Upgrading Pro-C	148
HCC - Valve Wiring	149
HCC - AC Wiring	150
HPC- WRCLIK and HC Flow Meter	153
Flow Meter - Install Chart	155
Flow Meter - Quick Start Guide	156
Flow Meter - Specifications	156
Flow Meter - Test	157
Flow Meter - Custom Flow Sensor Configuration	158
Flow Meter - Winterization	160
Sensors - Configuration	161
Flow Meters	161
Rain/Moisture Sensors	162
Wiring	162
Sensors - Clik Sensor Status	166
Normally Closed (Default Setup) All Hunter CLIK Sensors	166
Sensors - Installing Personal Weather Station	167

Master Valve - Configuration	168
How does it work?	169
Master Valve - HC	169
Master Valve - PRO-HC	170
Master Valve - HPC-FP (Panel for PC-400 controller)	171
Valve - Wire Distance	172

# Controller - Navigating Screens

The controller features a full color touchscreen making navigation easy.

The Home screen, shown below, has 3 buttons allowing you to view and run your irrigation zones, change controller settings or view status information.

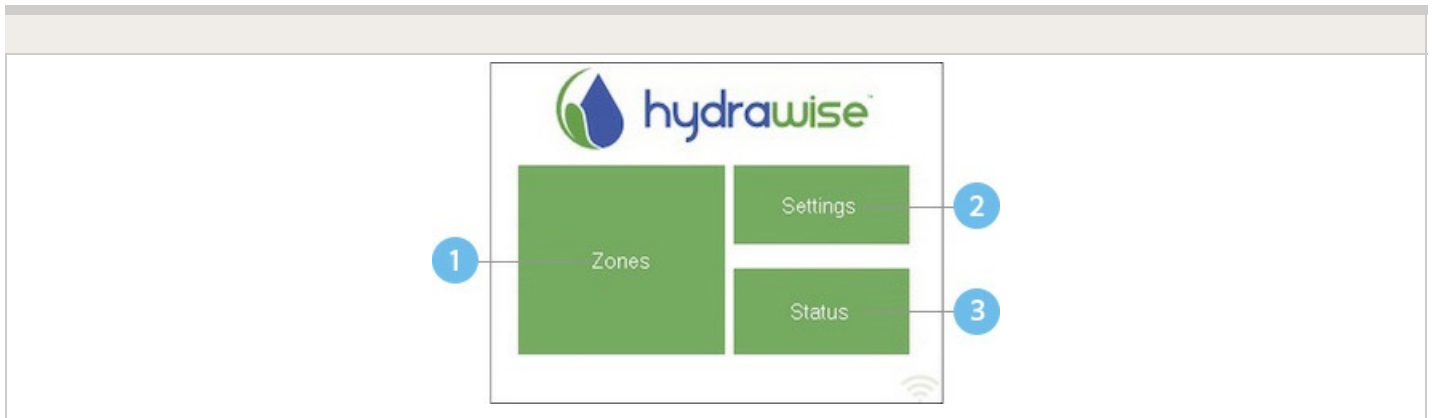

- 1 Touch to view all zones
- 2 Touch to change controller settings
- 3 Touch to view controller status information

Each screen (except for the home screen) has two buttons at the top of the page allow you to quickly navigate to the Home screen or the previous screen.



- 1 Go to previous screen (changes not saved)
- 2 Go to Home screen (changes not saved)
- 3 GREEN items indicate settings which can be changed
- 4 GREY items indicate status information

All items on each screen are color coded to indicate which screen elements are buttons and which screen elements indicate status information.

GREEN screen items indicate settings that can be changed. If you touch on the GREEN color item then you'll be able to change that setting.

GREY colored items indicate status information. Touching on these has no effect.

If you're entering information into the controller and use the Home or Back buttons then your changes on that screen will not be changed.

---

# Wireless - Connection Status Messages

The controller will show different status messages while connecting to your wireless router.

<b>Looking for Wireless</b>	Controller is currently scanning for local wireless networks.
<b>Connecting to</b>	Controller is currently trying to connect to your wireless router.
<b>Waiting for IP</b>	Controller has connected to your wireless router and is waiting for your wireless router to give it an IP address. Your wireless router must be configured as a DHCP server.

<b>Connected</b>	Controller has successfully connected to your wireless router.
<b>Local Connection Only</b>	Controller is acting as a local wireless router.

## Troubleshooting Wireless Connection Issues

After entering your wireless settings, the controller will connect to your access point. The connection process takes about 30 seconds.

Upon successful connection the wireless status will show **Connected**.

If your controller fails to connect to your wireless router check the following:

- Your password is entered It is case sensitive and must be at least 8 characters long.
- Check that the wireless security types match between the controller and your wireless Hydrawise recommends use of WPA2 security between the controller and your wireless router.
- We have WiFi specifications here: [WiFi Specs](#) <sup>[1]</sup>

---

# Controller - Viewing Controller Status

From the Home screen, navigate to the Controller Status by pressing Status > Controller Status.

The controller status screen shows your controller's connection to Hydrawise servers for synchronizing schedule and weather information.





- 1 Status of Connection to Hydrawise Servers
- 2 Your Serial Number. Used to link your controller to your account
- 3 Connection to Hydrawise Success Rate

## Server Status

A successful connection to the Hydrawise servers is indicated by **Sync'd** as the Server Status.

### SERVER STATUS MESSAGES

Message	Description
OK - updated xxx seconds ago	The controller is connected to Hydrawise and last got a configuration update xxx seconds ago. This is the normal state.
Wireless Down	Wireless is not connected
OK - Updating certificates	The controller is doing an initial upgrade from version 2.x to 3.x software. You should only see this once, if the controller is continually showing this then there is a problem - please contact Anthony with a video of the problem.
OK - Downloading Software	The controller is doing a firmware upgrade. During this period no configuration changes will be processed by the controller.
	The controller is not connected and is waiting xxx



<b>Connecting in xxx seconds</b>	seconds before attempting to reconnect to the internet. When a connection fails we do not try to reconnect immediately - there is an escalating delay between 5 seconds the 60 minutes (worst case after 33 unsuccessful connections). There is a “Reconnect Now” button on the Controller Status screen to force a reconnection immediately if you’re in front of the controller.
<b>Connecting to the Internet</b>	The controller is attempting to connect to the internet
<b>Connecting to Hydrawise</b>	Controller has connected to the internet and is now connecting to the Hydrawise servers
<b>OK - subscribing to updates</b>	Controller has connected to Hydrawise and is getting its configuration
<b>OK - processing cloud update</b>	Controller is connected to Hydrawise and is processing a configuration change
<b>Updating Wi-Fi firmware</b>	The controller is updating the Wi-Fi firmware to 19.5.4. During this period no configuration changes will be processed by the controller.
<b>Updating Pro-C adapter</b>	The controller is updating the Pro-C adapter software. During this period no configuration changes will be processed by the controller.

## Success

Success percentage - this is the percentage of time the controller has been connected to Hydrawise. We measure this over a 6-hour time frame. 100% means it was always connected, 80% means that for 20% of the time it was not connected.

A low success percentage will indicate a poor wireless connection between the controller and your access point.

To improve your wireless signal strength you could try the following –

- Move the controller closer to your wireless router.
- Remove any obstacles in a direct line of sight between the controller and your wireless router such as metal items (metal is an extremely good isolator for WiFi signals).
- Move your wireless router closer to the controller.
- Install a higher gain antenna on your wireless router.
- Use Ethernet to a location closer to the controller and install a new wireless router.
- Consider a WiFi repeater/extender between your wireless router and the Hydrowise controller to boost the signal strength.
- Consider moving the controller away from potential sources of interference, including microwave ovens, nearby base stations using adjacent channels or cordless telephones operating in the 2.4GHz range (you could also change the channel your phone uses).

Note that the Hydrowise unit is designed to work in poor wireless environments. However, if you wish to manually run or stop a zone and the wireless signal is down then these actions will fail.

## Offline

If the controller loses internet for more than 24 hours you'll receive a notification email.

The controller will go into an offline mode. In offline mode, your controller won't be able to access local weather conditions such as rainfall or evaporation and will revert to a pre-defined program.

- For Smart Watering zones, the controller will adjust each zone's watering length based on your offline watering budget and will water at each zone's configured peak watering frequency.
- For Time Based Watering zones, the controller will adjust each zone's watering length based on your offline watering budget and will water at each zone's configured watering frequency.
- For more information on Smart and Time Based Watering, see "[Configuring Irrigation Zones](#)" <sup>[2]</sup>.
- Note that Cycle & Soak is not supported in Offline Mode and each zone will water for its full watering length without pausing.
- The controller will only water at your configured Program Start Times.

## Saving Settings

The controller does not need a battery, all settings are saved in a non-volatile RAM (memory).

# Serial Number

The serial number is used to link your actual controller with your Hydrawise account. This number is also printed on the rear of the controller.

## Controller - Viewing Network Information / Testing Internet Connectivity

From the Home screen navigate to the Network Status by pressing Status > Controller Status.

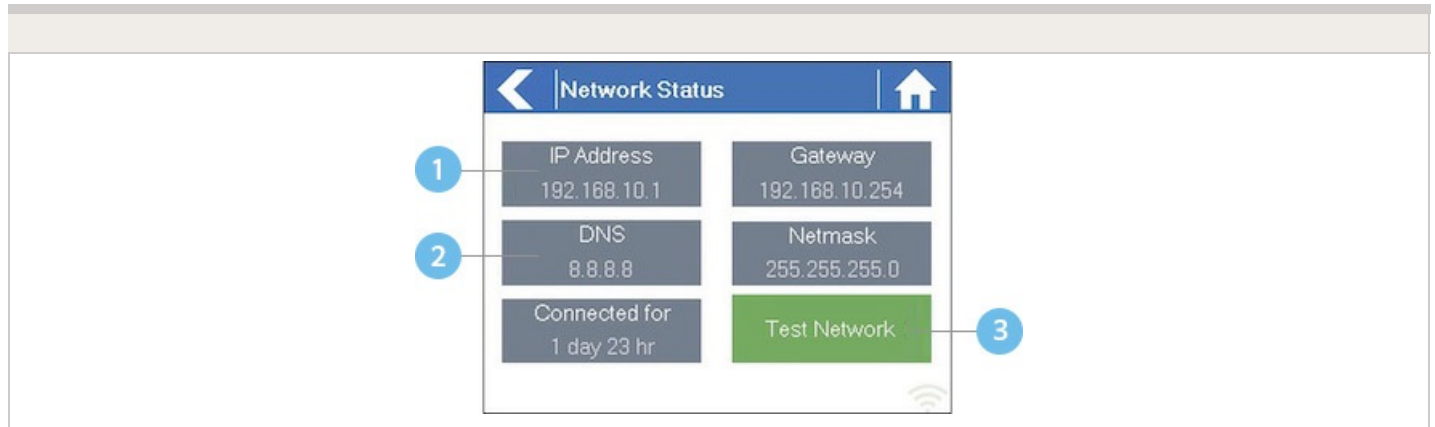

- 1 IP Address (set by your wireless router)
- 2 DNS Address (set by your wireless router)
- 3 Network Test Button

All settings on this page are provided to the controller by your wireless router when it first connects via a protocol, known as DHCP. If any of these settings appear incorrect please change them in your wireless router.

Once the controller has successfully connected to your wireless router the Test Network button can be used to test network connectivity for troubleshooting purposes. The network test will verify connectivity to 4 destinations –

### Test Network

Message Description **Checking WiFi** Performs a ping test to the Gateway address listed in the Network Status screen. If this test fails, check that you don't have MAC address filtering enabled on your router. **Checking DNS** Performs a ping test to the DNS address listed in the Network Status screen. If this test fails, check that the DNS address is correct – if it is wrong then correct the DNS address under DHCP Settings on your wireless router. It is possible that this test may fail if the DNS server doesn't accept ping requests which do not indicate an issue. **Checking Internet** Performs a ping test to the Google server at IP address 8.8.8.8. This is a well-known server which accepts ping requests on the internet. If this test fails then it indicates an issue with the internet configuration of your wireless router. **Checking Hydrowse** Performs a ping test to the Hydrowse servers. If this test fails then it may indicate an issue with the internet configuration of your wireless router.

---

# Controller - Viewing Time and Date

Time and date settings are synchronized with the settings that you configure in the Hydrowse app. The timezone is set based on the location you entered during the app wizard.

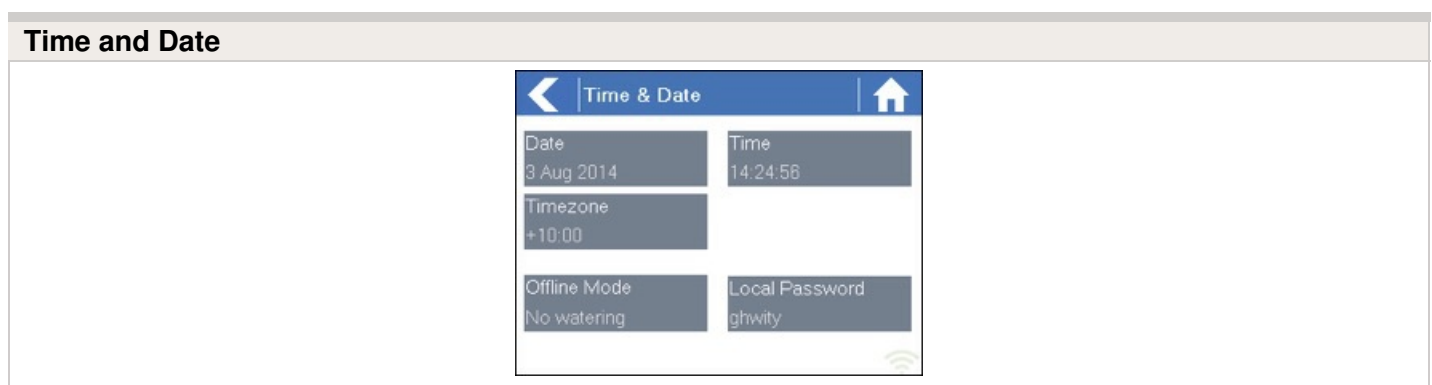

If your controller is running as a stand-alone controller (WiFi is disabled) then the date, time and time zone will be shown on a GREEN background can be changed.

---

# Controller - Installing and Wiring

You can also find the instructions included with the controller on our [Quick start Guides](#) <sup>[3]</sup> page.

For instructions on installing your residential controller, please visit our basic wiring setup page for PROHC and HC models [here](#) <sup>[4]</sup>.

**NOTE:** Once you've wired and installed your controller, please see [Configuring Your Controller](#) <sup>[5]</sup> for instructions on how to connect to your Wi-Fi.

---

## Controller - Function Paths

Below is a list of function paths for use with the controller interface in both online mode and offline mode.

ONLINE MODE
<b>Change Wi-Fi/Check Status:</b> Home>Settings>Wireless>Select a Setting to Modify
<b>Controller Status:</b> Home>Status>Controller Status
<b>Program Expander:</b> Home>Status>Expansion Modules
<b>Manually Run Zone(s):</b> Home>Zones>Select Zone> Run>Enter Time>OK
<b>Model:</b> Home>Status>Controller Status
<b>Network Status:</b> Home>Status>Network
<b>Reboot Controller:</b> Home>Settings>Config>Reboot Controller

**Reset Controller:** Home>Settings>Config>Factory Default

**Run Wizard:** Home>Settings>Run Wizard

**Sensor Status:** Home>Status>Sensor

**Serial Number:** Home>Status>Controller Status

**Server Status:** Home>Status>Controller Status

**Test Network:** Home>Status>Network>Test Network

**Test Zone:** Home>Status>Zone Tester

**Time and Date:** Home>Status>Time

**Version Number:** Home>Status>Controller Status

**Zone Status:** Home>Zones>Select Zone

#### OFFLINE MODE

(Note: Changes can be done in offline status only when Wi-Fi is disabled.)

**Adjust Time:** Home>Settings>Offline Status>Time

**Disable Wi-Fi:** Home>Settings>Offline Status>Disable Wi-Fi

**Program Expander/Check Status:** Home>Settings>Offline Status>Expansion Modules

**Program Sensor/Check Status:** Home>Settings>Offline Status>Sensors

**Program Start Times:** Home>Settings>Offline Status>Program Start Times

**Set Seasonal Adjust:** Home>Settings>Offline Status>Seasonal Adjust

# Controller - Manual Operation

You can run an irrigation zone on demand from the Hydrowise unit prior to having the system connected to wifi.

## Running a zone manually from the controller

From the **Home** screen, navigate to the **Zone Summary** screen by pressing **Zones**.

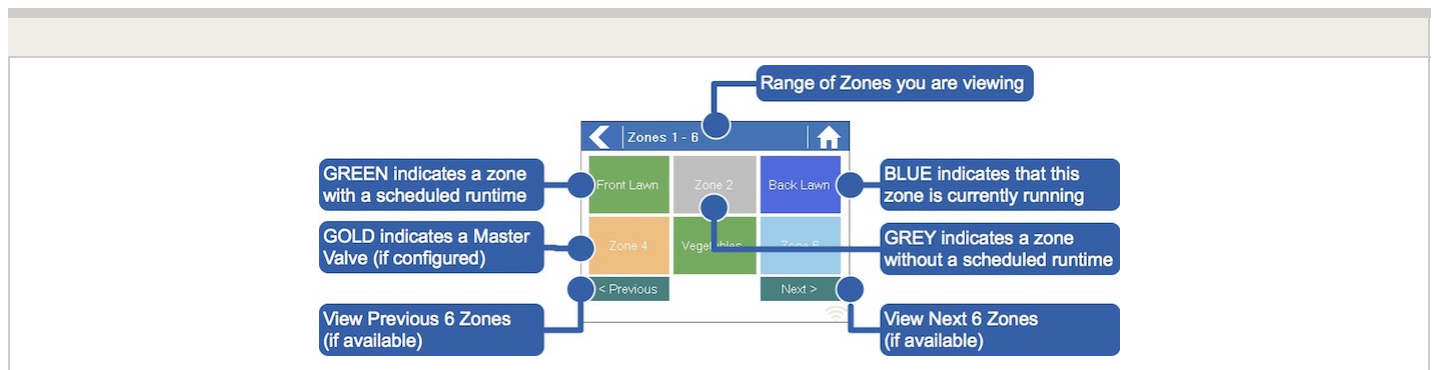

The Zone Summary screen shows the status of six zones at a time. To view the next or previous group of zones, use the **Next** and **Previous** buttons. The current range of zones that you are viewing is indicated at the top of the screen.

From the Zone Summary screen, touch the zone you wish to view.

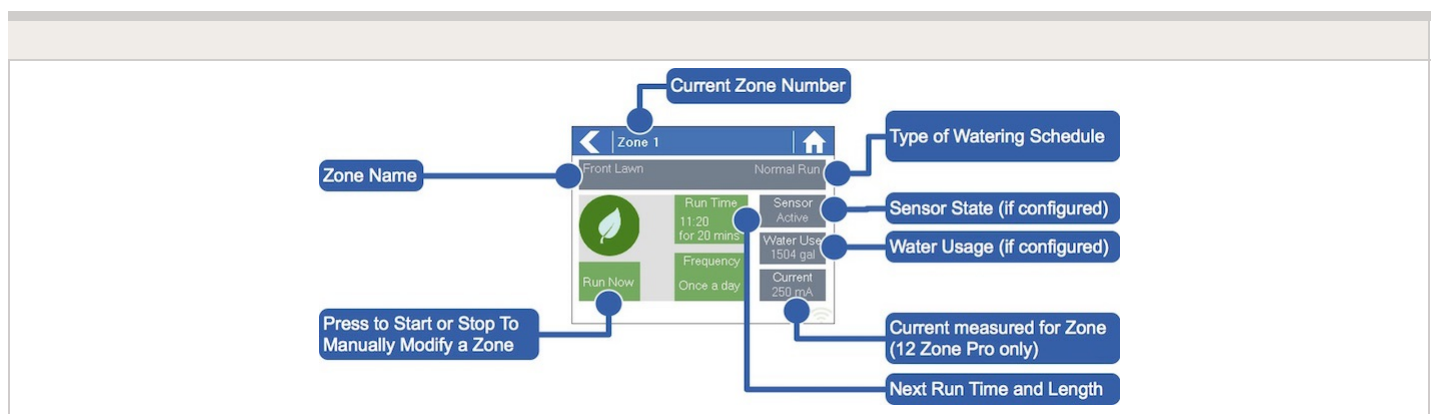

From the Zone Status screen, you can manually start a zone using the **Run Now** button. When started, the zone will run for the zone's default configured run length. This can be overridden by clicking on **Run Time** prior to manually starting the zone.

When a zone is running, the **Run Now** button will change to **Stop**. This allows you to stop a running zone.

---

# Controller - Factory Default

Please follow the steps below to perform a factory reset on your controller. When the controller goes back online, the settings in the software will sync back into controller.

1. From the home screen, tap on **Settings**.
2. Next, press **Config**.
3. Press **Factory Default**.
4. Finally, press the **Erase Config**.

## STEP 1

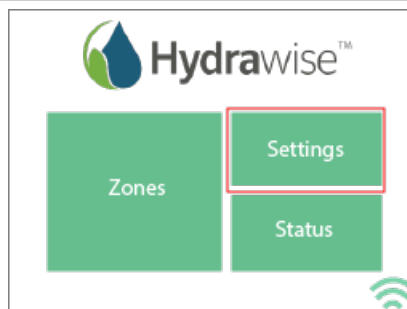

## STEP 2



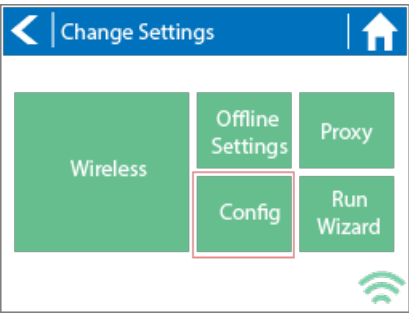

### STEP 3

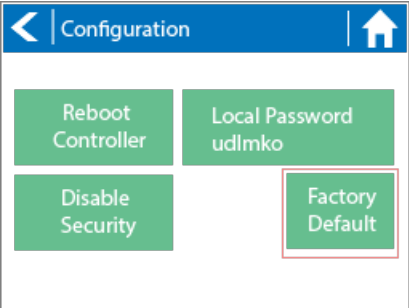

### STEP 4



Congratulations, you have now successfully factory reset your controller. The controller is now ready for fresh configuration settings, either manually or automatically through synchronization with your Hydrowise account.

To link your controller to your account, refer to [Linking Your Controller to Your Account](#) (6).

# Controller - Serial Number Location

Your controller's serial number is found on the rear of your controller or on the controller's touch screen.

To access the serial number on the touch screen, follow these steps:

1. From the Home screen, click **Status**.
2. Then click **Controller Status**.
3. The serial number is shown on this screen. Note: The serial number contains only letters **a through f** and numbers **0 through 9**.

## STEP 1

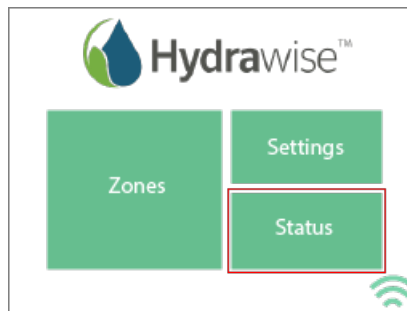

## STEP 2

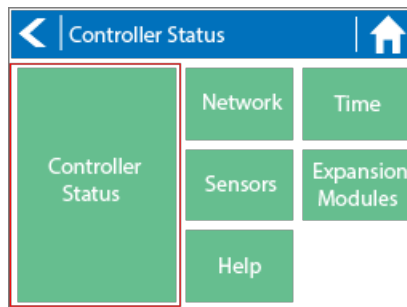

## STEP 3

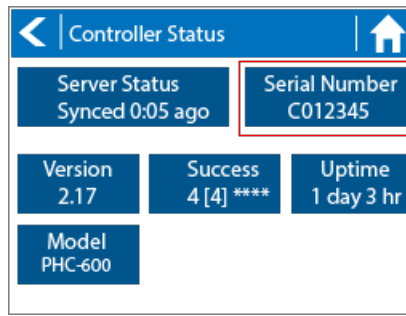

To link your controller to your account, please refer to this article [Linking a Controller to My Account](#) <sup>[7]</sup>.

## Account - System Shut Off (Winterization)

In the application (Smart Device or PC), you can suspend your system for any period of time for winterization purposes or basic system shut down.

- For information on winterizing using the HC flow meter, [CLICK HERE](#) <sup>[8]</sup>.
  - For more information on the winterization procedure, [CLICK HERE](#) <sup>[9]</sup>.
1. **CLICK** on the gear above the zones.
  2. Next, **CLICK** "Suspend all zones."
  3. Select the date range for which you would like the controller to be suspended. Use the arrow in the gray drop-down box to select a day and month. Once the date is selected, **CLICK** suspend.
  4. Your zones should all appear faded and you will get the following message: **"All zones suspended for XX months."** This message will disappear after a few minutes.
  5. If you wish to restart your system before the due date, **CLICK** the single gear above your zones, and **CLICK** "Suspend all zones." Then, **CLICK** "Remove suspension" in RED. The suspension will be removed and the system will be ready for watering.

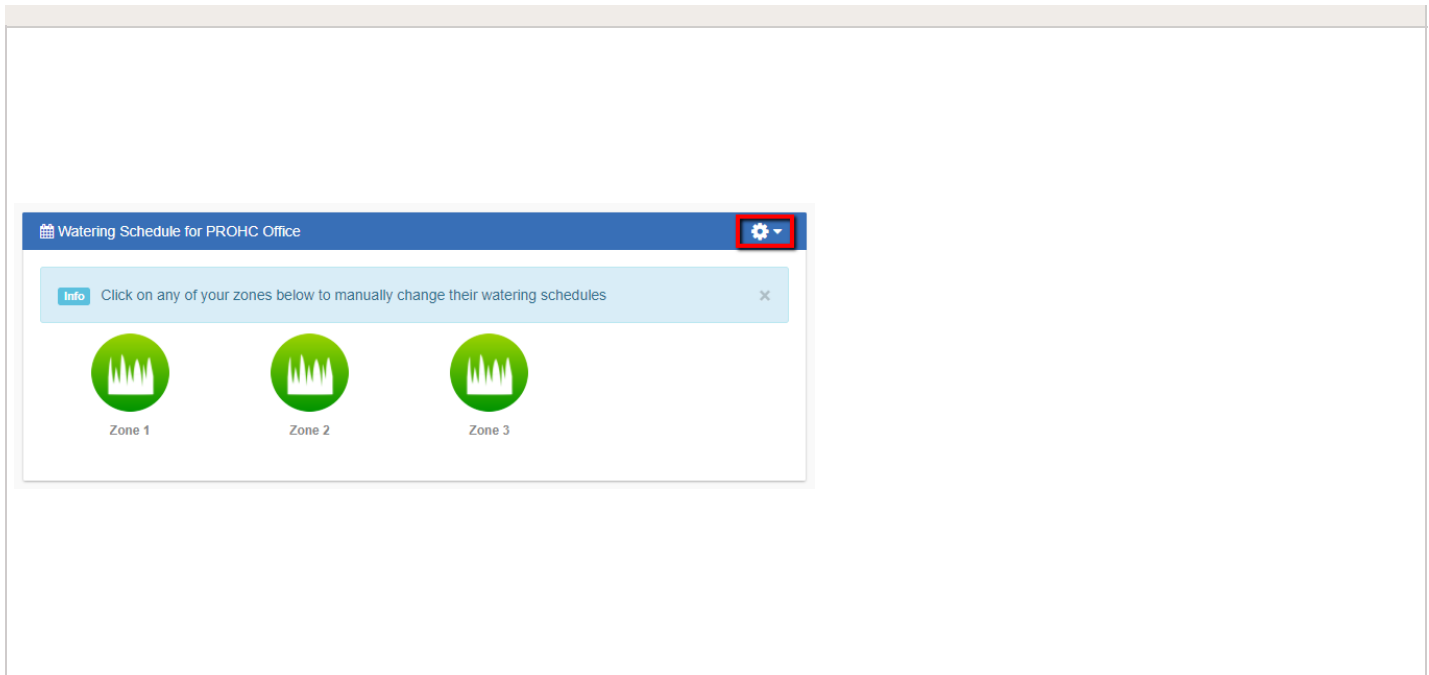

## STEP 2

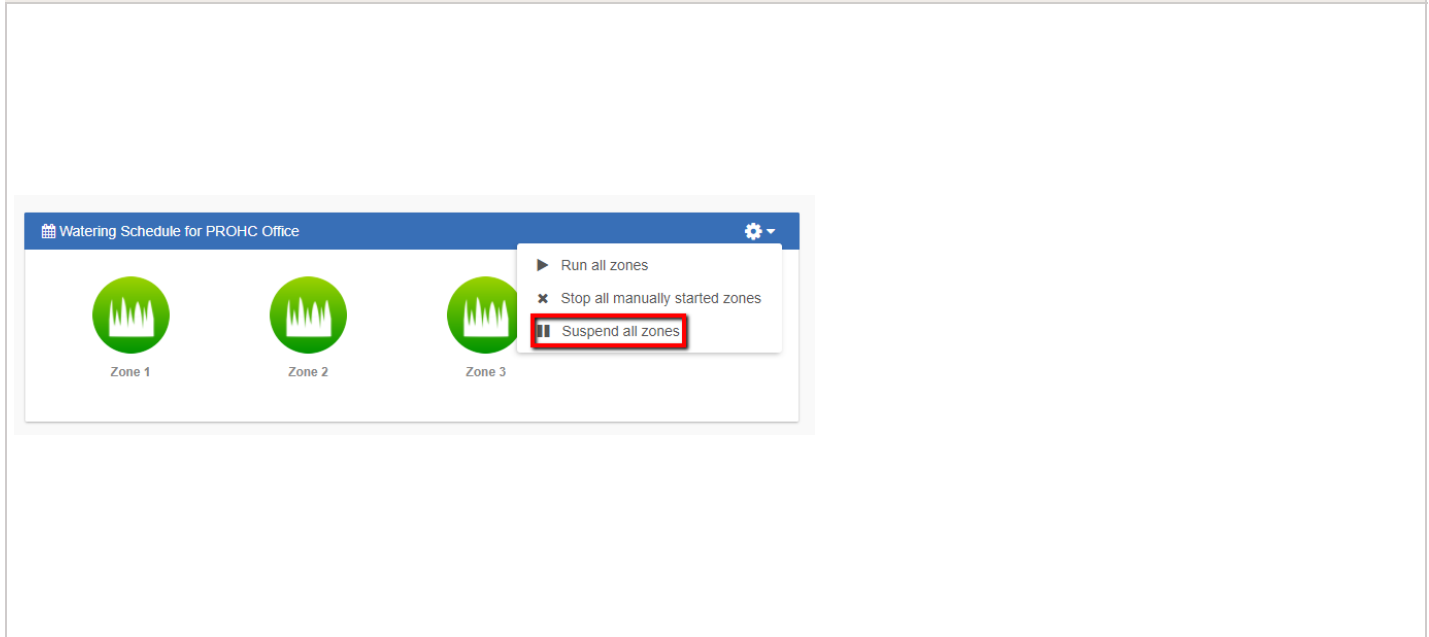

## STEP 3



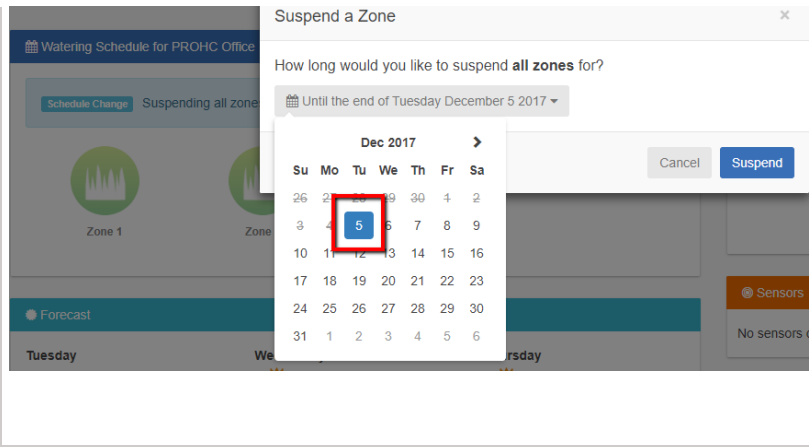

## STEP 4

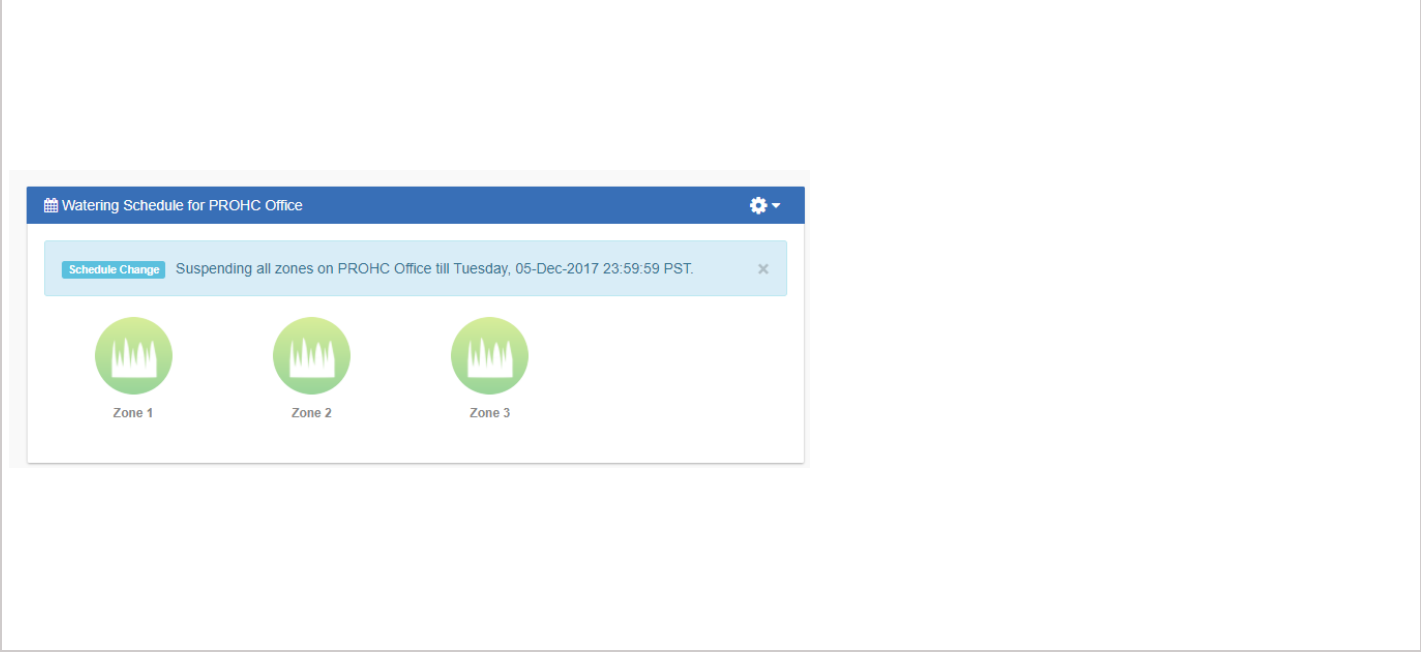

## STEP 5

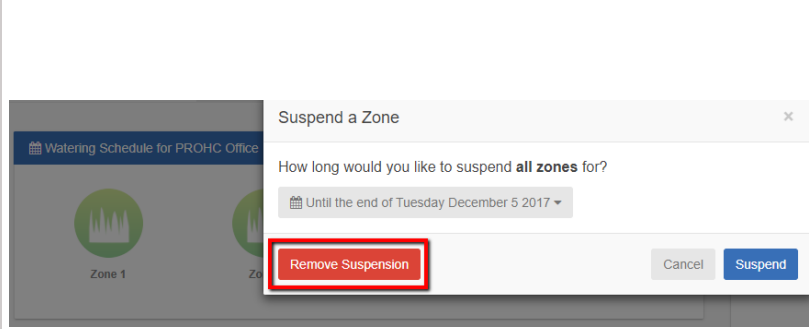

---

# Account - Location

## Mobile Quick View

---

The location is synchronized after the settings are configured in the Hydrawise app. The time zone and forecast are automatically set when the **location** is entered during the app set up wizard process. In the event this setup needs to be changed or updated, we

recommend editing the setting in the application under the Weather station tab.

Please view the steps and screenshots to set the weather station location:

1. Click on the settings tab on the upper right and select "**Weather Stations.**"
2. Enter the "**complete street address.**"
3. Regional setting will "**automatically**" be updated to the correct timezone.

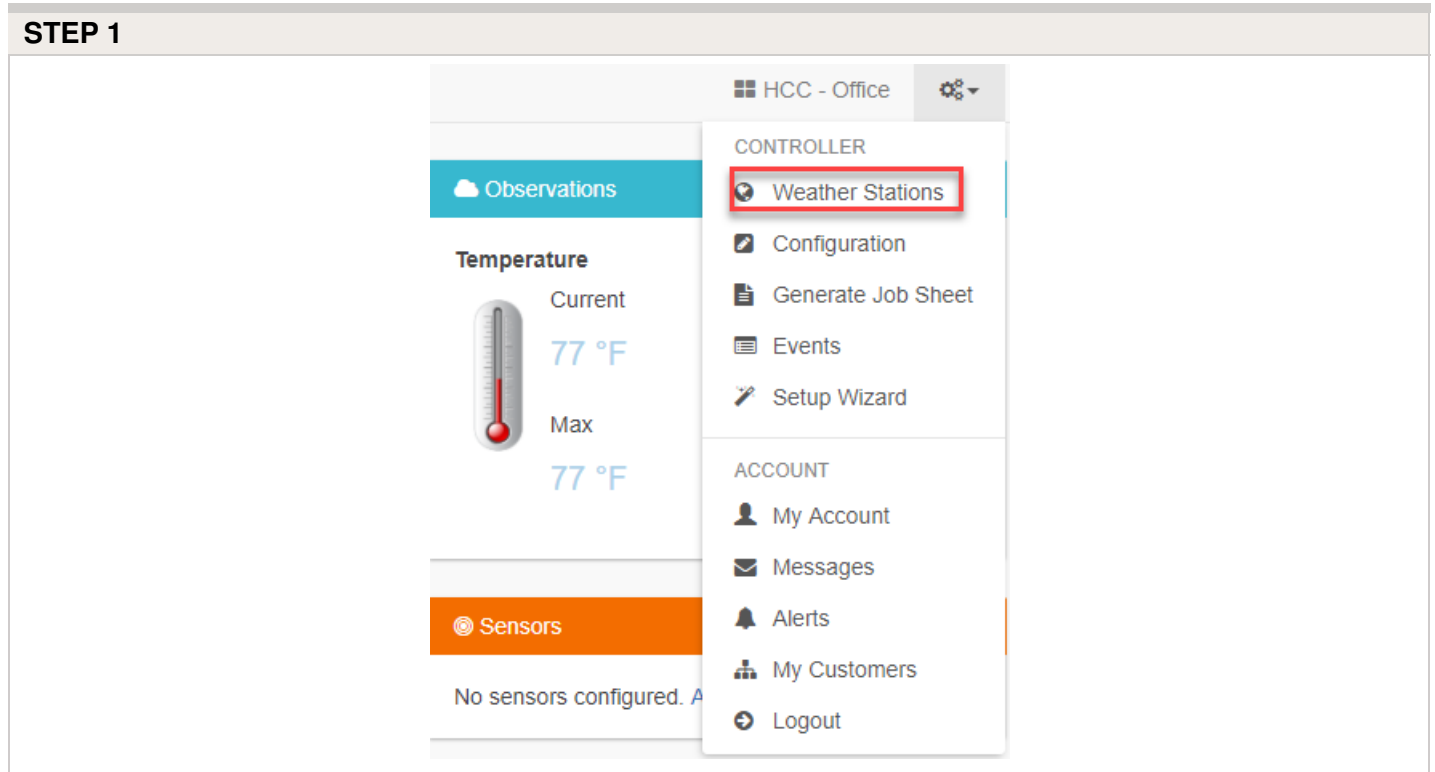

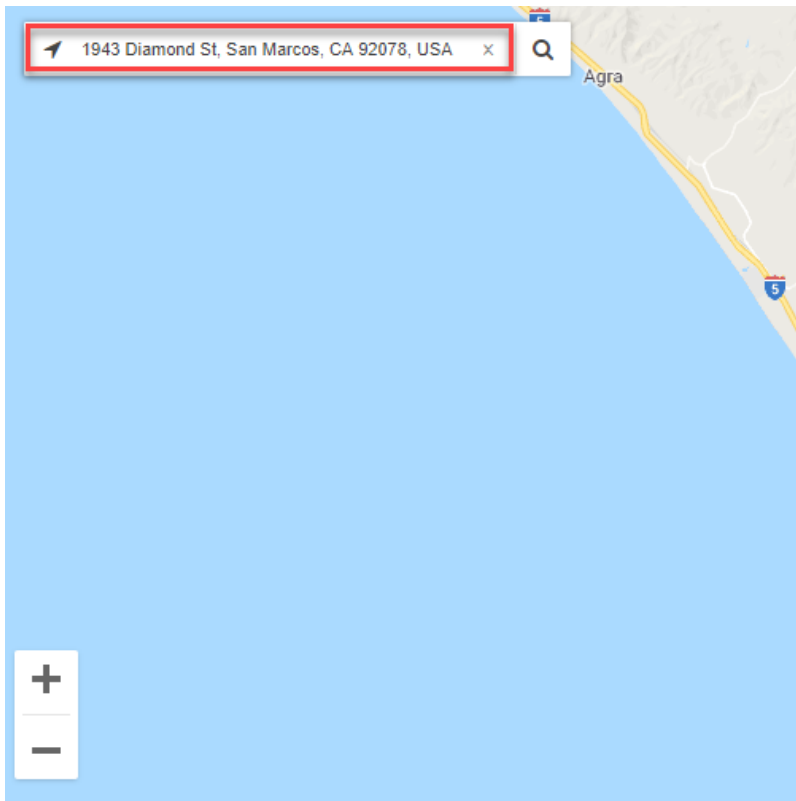

### STEP 3

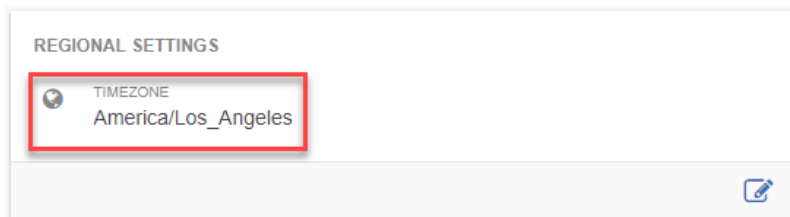

**NOTE:** If your controller is running in offline mode (WiFi is disabled) then the date, time and time zone will be shown on a GREEN background can be changed.



# Account - Language

For information on changing the language on your account, please view the steps and screenshots to access this feature:

1. Click **"My Account"** under the settings tab on the upper right.
2. Click the  icon in the user settings box.
3. Choose the **"language"** and select **"ok."**

## STEP 1

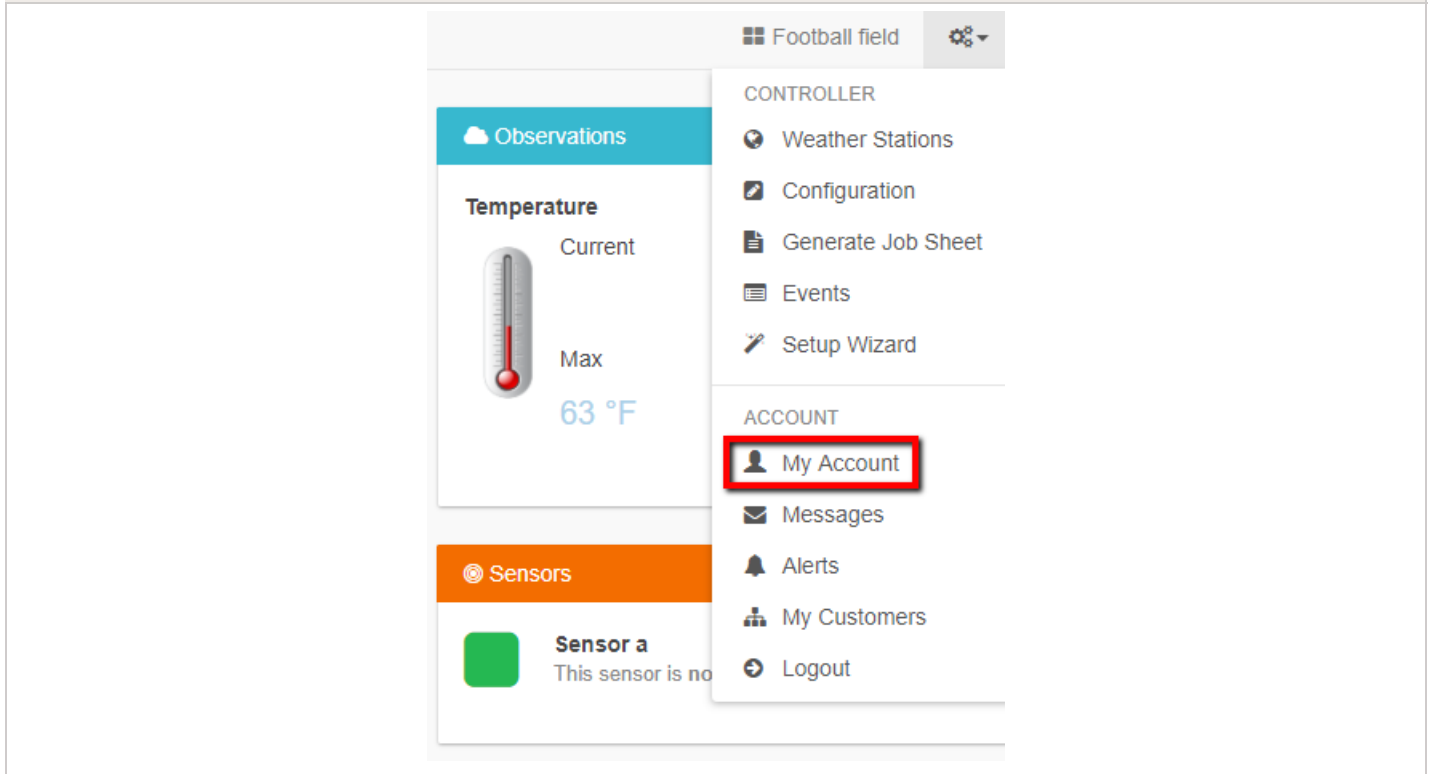



## STEP 2

**USER SETTINGS**

 UNITS OF MEASUREMENT  
Celsius & Millimeters

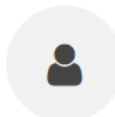
 LANGUAGE  
English

  
Hydrawise Contractor  
contractor@hydrawise.com



### STEP 3

Edit User ×

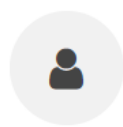
  
Change picture

**Name**

**Email Address**

**Units of Measurement**

**Language**

# Account - Controller Status

The message options below will display on the home dashboard under "**controller status**" when logged into your Hydrawise account. See example of a good wifi connection below:

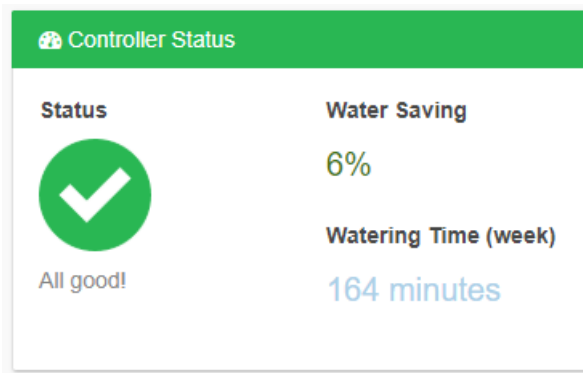

Controller Status	
<b>Not Connected</b>	The controller is not connected to Hydrowise. We detect this within about 7 minutes so this would be a connectivity problem.
<b>All Good</b>	The controller is connected to Hydrowise and the controller has the latest config.
<b>Waiting for Confirmation</b>	The controller is connected to Hydrowise but there is a difference between the app settings and the controller settings. This icon is normal to see just after a configuration change (including changes from the dashboard such as manual start/stop) is made but should only be visible for a few seconds.
<b>Out of Sync</b>	The controller is connected to Hydrowise and there is a difference between the cloud configuration and what the controller has reported and it has been longer than 60 seconds since the change happened. This is not a normal state however you will see this if the customer has configured more than 4 program start times per zone or 4 global start times due to controller memory.

**Note:** That you can have more than the recommended start times which will all run as long as the controller remains online, it will just say out of sync for the reasons above. If the controller goes offline it will only run the first 4 individual start times and the first 4 global start times.

## Account - Linking Controller

After you receive your Hydrowise irrigation controller, you will need to link it to your Hydrowise account.

There are two locations where you can link your controller to your account:

- During the setup wizard (optional)
- From the controller **Dashboard**

**NOTE:** You only need to link your controller to your account once. If you provided a serial number when going through the setup wizard, you've successfully linked your controller to your account and you can ignore these instructions.

To link your controller through your account Dashboard, follow these steps:

1. [Log in to your account](#) [10].
2. On the Dashboard, click on the **Settings icon** located on the blue Watering Schedule bar. Then click the **Link to controller...** button.
3. Enter your controller's **serial number**. The eight-character serial number is found on the side of the unit. The serial number is not case-sensitive.

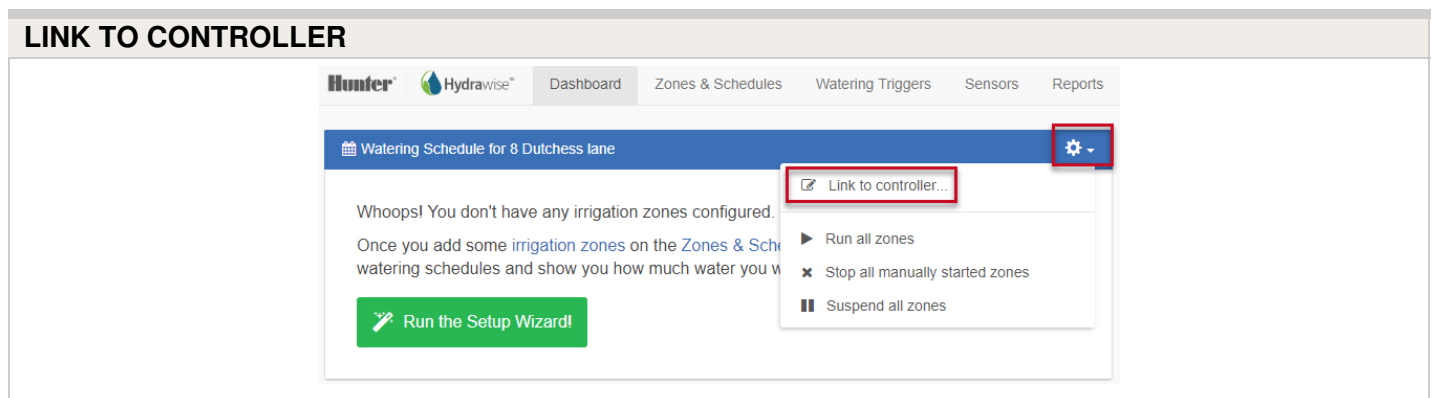

Once you've entered the serial number, your controller will automatically download your settings and begin watering based on your watering schedules.

## Account - Adding a Controller

### Mobile Quick View

For information on adding a controller to your account on the PC, please see the steps and screenshots below:

1. Select the **"Three Gear Icon"** on the upper right on the dashboard.
2. Click **"My Account"**
3. Click the **+** button in the my controllers section.
4. Add the new controller by inputting the name, serial number, location and model.
5. Click **"create"**.

Plan	Max Controllers
Home Plan	3 Controllers
Enthusiast Plan	5 Controllers

#### STEPS 1-2

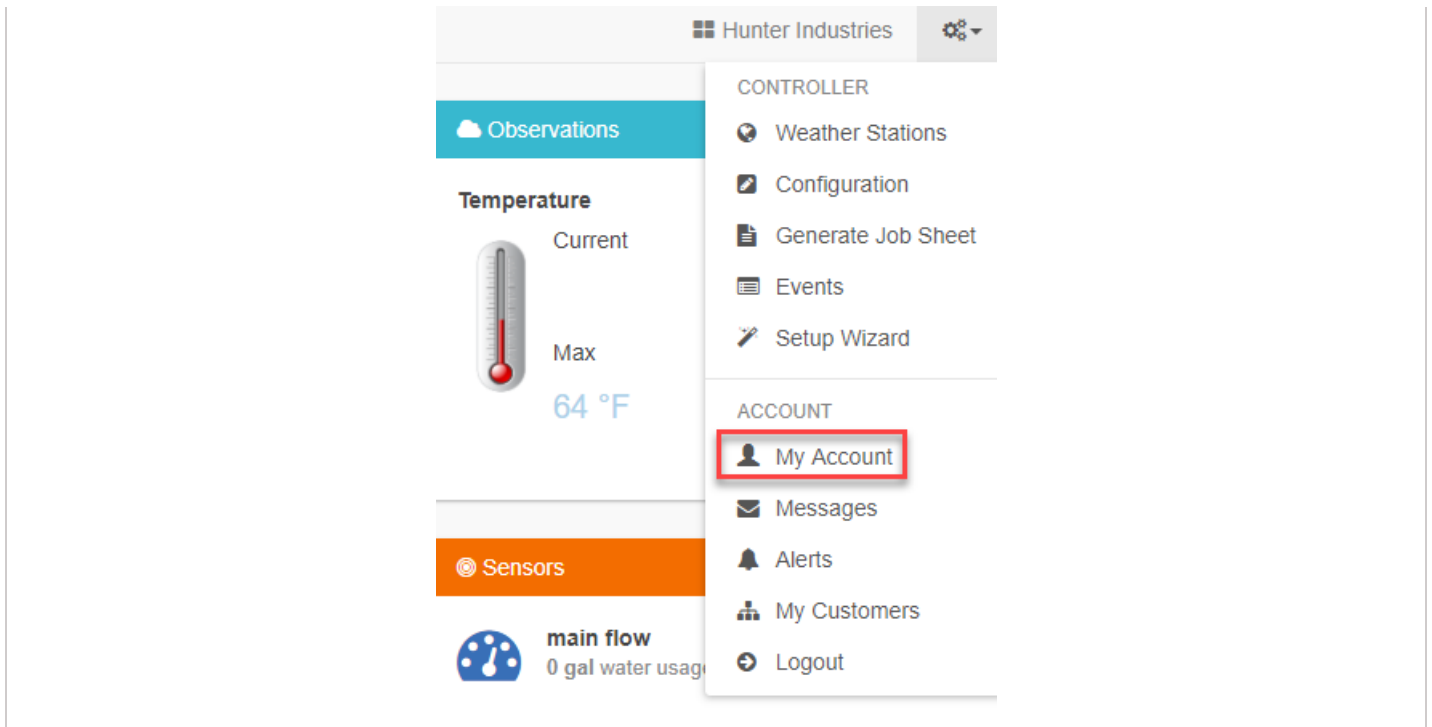

### STEP 3

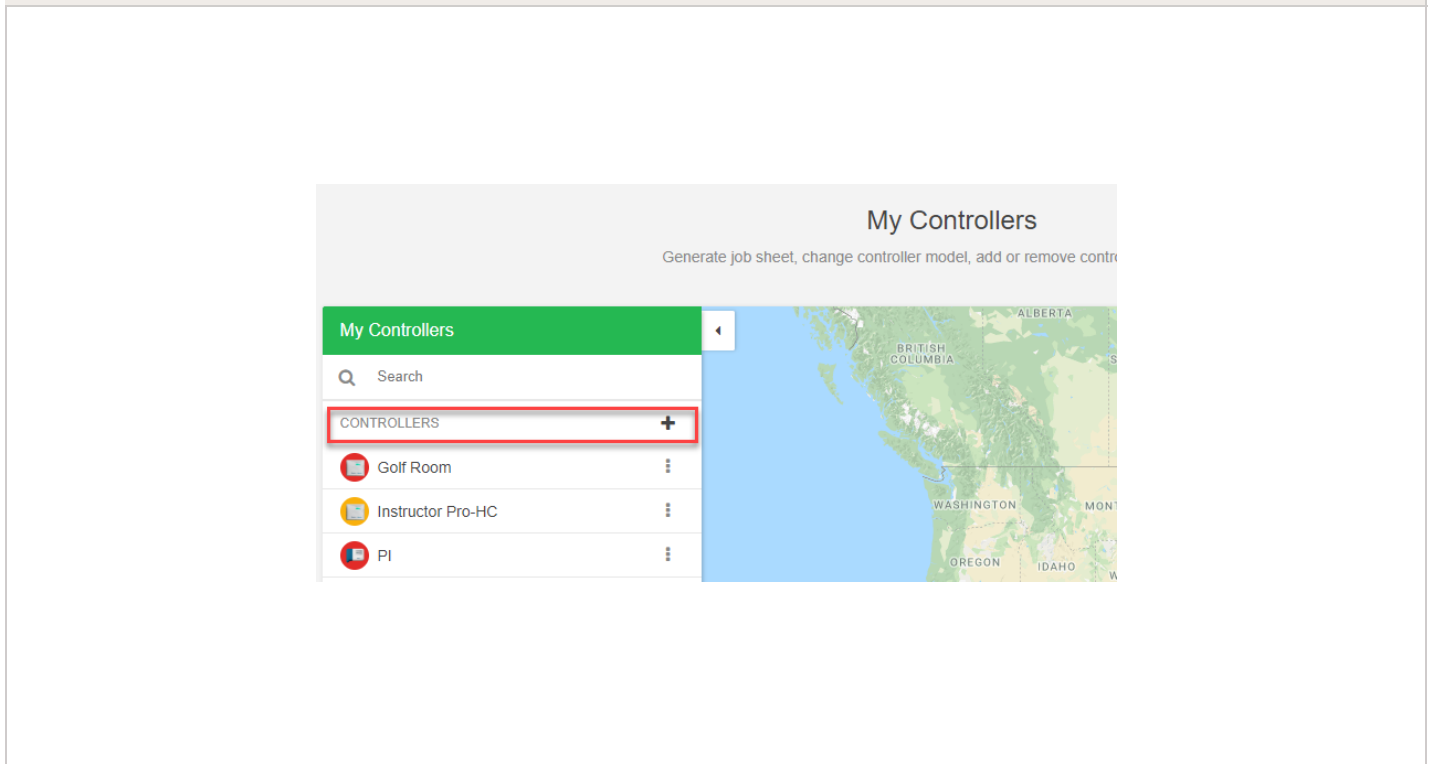

### STEP 4

Add New Controller ✕

**Controller name**

Enter the name of the new controller

**Serial number**

If you know the serial number of the controller enter it here, otherwise leave it blank

**Location**

Please enter your location

Cancel < Prev Next > Create

## STEP 5

Add New Controller ✕

**Controller model**

Please choose your controller model



**HC**  
6 or 12 Zone Controller

6 Zones

12 Zones



**Pro HC Indoor/Outdoor**  
6, 12 or 24 Zone Outdoor Controller

6 Stations

12 Stations

24 Stations



**HPC**  
Pro C WiFi Facepanel Upgrade

Up to 16 Stations

Cancel < Prev Next > Create

---

# Account - Zones and Schedules

Hydrawise supports 3 types of watering - [Time Based](#) <sup>[11]</sup>, [Smart \(ET\) Watering](#) <sup>[12]</sup>, and [Virtual Solar Sync](#) <sup>[13]</sup>. Choosing which style of watering depends on a number of things, including your type of irrigation zone, if any watering restrictions exist in your area and personal preference (for example, for people who like to know that their irrigation will start on Mondays, Wednesdays and Fridays then Time Based Watering is ideal). Other topics covered in this article include:

[Add a Zone](#)

[Add Zone Images](#)

[Configure Master Valve](#)

[Configure Program Start Times and Water Days](#)

[Configure Preconfigured Water Schedule](#)

## Adding a Zone

To add an irrigation zone, navigate to the **Zones & Schedules** page in your Hydrawise account and click on **Add a New Zone**. The Zone wizard will be displayed.



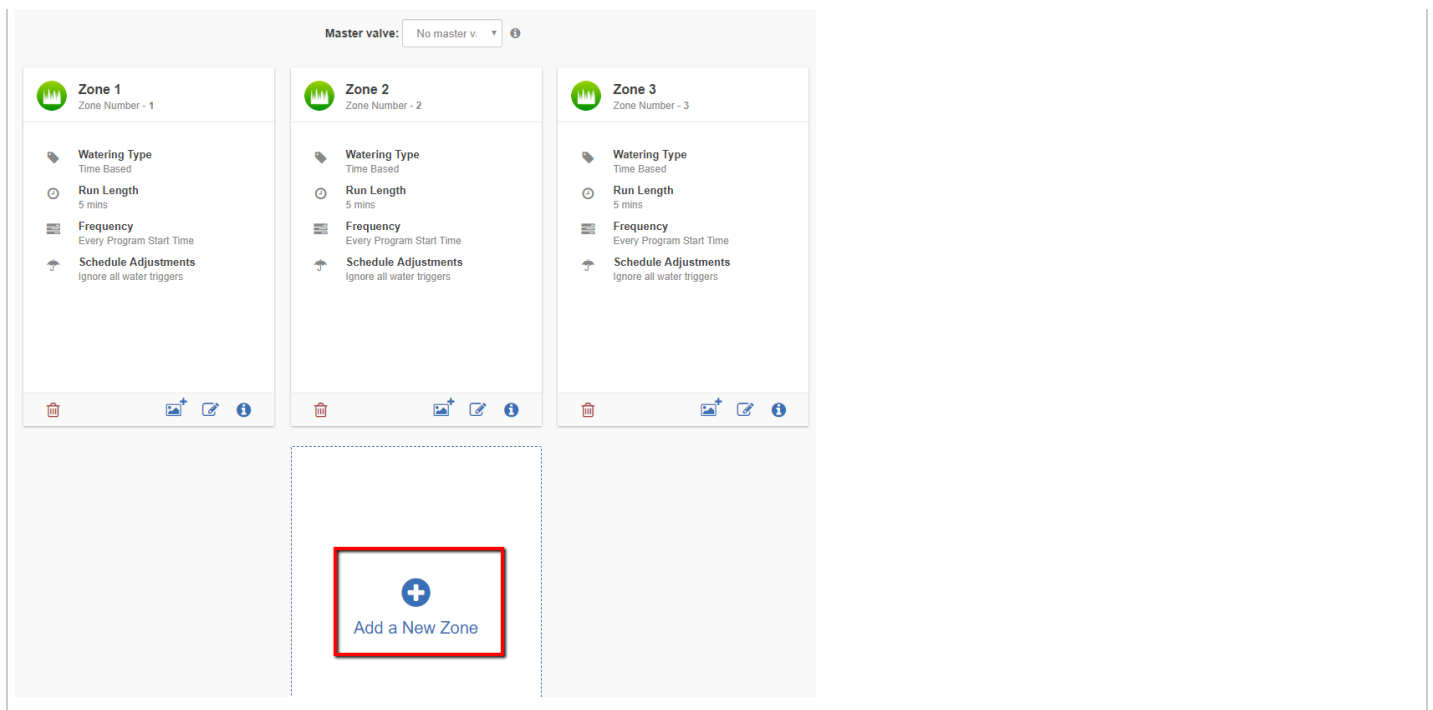

Fill in the Zone Details:

**Zone Name:** Name for each irrigation zone. Zone names are displayed on the Hydrowise controller and are used in your Hydrowise account to show run times and allow manual modification of watering schedules.

**Zone Number:** The zone number for each irrigation zone should match the number you have used when wiring the controller.

**Zone Icon:** Choose an icon which will be used to display the zone on the dashboard. If you have uploaded an image for this zone you can choose it to be displayed on the dashboard instead.

**Watering Type:** Select a watering mode for this zone. A zone can use Smart (ET) watering or Time Based watering, which are described below.

Depending on the type of watering you chose, fill in the details for Time Based, Smart (ET) Watering or Virtual Solar Sync.

## Time Based Watering

**Watering Type:** Choose whether to set the information manually or choose from a list of preconfigured watering schedules.

**Enter Time and Frequency:** allows you to manually set the watering length and frequency.

**Use a Preconfigured Watering Schedule:** add a preconfigured watering schedule or use

one you've previously created. If your controllers are managed by a contractor, you may see preconfigured watering schedules that your contractor has created, which you can also use.

**Enter Time and Frequency:** If you choose to enter the time and frequency, the following fields are available:

**Watering Length:** The number of minutes this zone will run for each time.

**Watering Frequency:** Choose how often to water the zone.

**Schedule Adjustment:** Choose how to adjust the watering time based on your weather triggers.

**Use a Preconfigured Watering Schedule:** If you choose to use a preconfigured Watering Schedule you can either choose from a list of schedules you've previously created, or add a preconfigured watering schedule by entering the watering length and frequency and schedule modifications as per the fields above. If your controllers are managed by a contractor, you may see preconfigured watering schedules that your contractor has created, which you can also use.

**Cycle and Soak:** Cycle and Soak is the ability to break the watering time for a zone into periods of watering (cycle) and pause (soak) to allow the water to soak into the soil without runoff.

You can enable or disable Cycle and Soak. If you enable it, you need to specify the cycle and soak periods:

- Cycle Time: the maximum number of minutes the zone can run for
- Soak Time: the minimum time between zone watering to allow the water to soak into the soil

**Tuning:** Adjust the watering time for this zone from the calculated time. This allows you to fine tune your watering if your zone appears to be too dry or wet.

## Smart (ET) Watering

**Watering Type:** Choose whether to set the information manually or choose from a list of preconfigured watering schedules.

**Enter Time and Frequency:** allows you to manually set the watering length and frequency.

**Use a preconfigured Watering Schedule:** add a preconfigured watering schedule or use one you've previously created. If your controllers are managed by a contractor, you may

see preconfigured watering schedules that your contractor has created, which you can also use.

**Enter Time and Frequency:** If you choose to enter the time and frequency, the following fields are available:

**Watering Length:** The number of minutes this zone will run for each time.

**Peak Season Watering Frequency:** How often the zone will normally run during your peak irrigation period. This frequency will be automatically adjusted throughout the year based on actual evaporation and rainfall.

**Use a Preconfigured Watering Schedule:** If you choose to use a preconfigured Watering Schedule you can either choose from a list of schedules you've previously created, or add a preconfigured watering schedule by entering the watering length and frequency and schedule modifications. If your controllers are managed by a contractor, you may see preconfigured watering schedules that your contractor has created, which you can also use.

Note that the Schedule Adjustment option in a preconfigured Watering Schedule is not used for Smart (ET) watering zones.

**Cycle and Soak:** Cycle and Soak is the ability to break the watering time into periods of watering (cycle) and pause (soak) to allow the water to soak into the soil without runoff. You can enable or disable Cycle and Soak. If you enable it, you need to specify the cycle and soak periods:

- Cycle Time- the maximum number of minutes the zone can run
- Soak Time- the minimum time between zone waterings to allow the water to soak into the soil

**Tuning:** Adjust the watering time for this zone from the calculated time. This allows you to fine tune your watering if your zone appears to be too dry or wet.

## Adding Zone Images

You can upload multiple pictures of each of your irrigation zones to the Hydrowise system. To upload an image click on the Image Add button  next to the Zone Edit button.

You can upload multiple images per zone. The total number of images that can be uploaded is based on the images size and is different for each account's Plan Subscription.

After an image is uploaded you can select an image to be displayed on the Dashboard by editing the zone  and selecting the image in the Zone Icon list

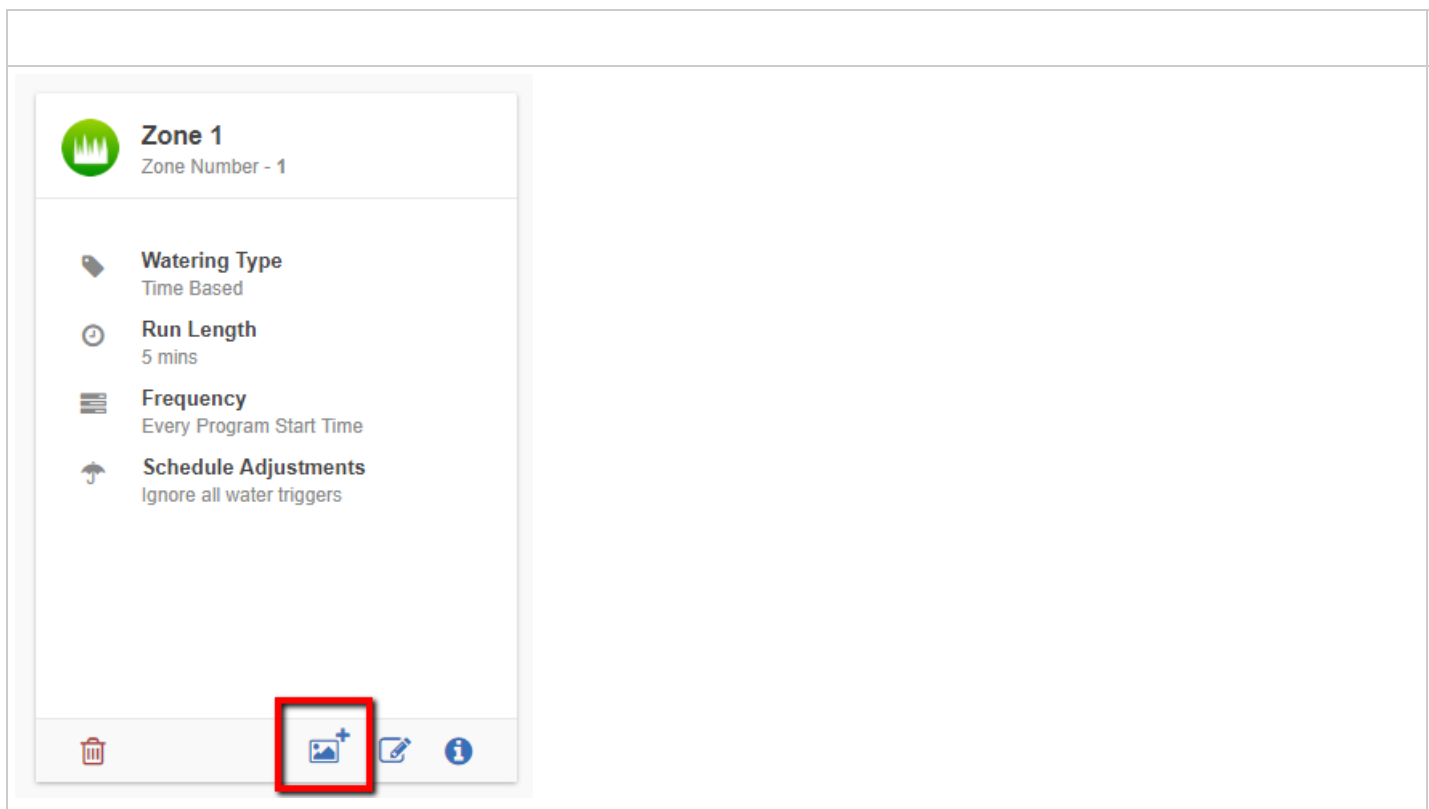

## Configuring a Master Valve (Sensors and Valves Section)

A master valve is an automatic valve that is installed at the point where the irrigation system connects to the water supply. (Sometimes this circuit is called a “pump start circuit.” Both types of circuits work similarly and can be used for a pump and/or a master valve.) The controller turns the master valve on and off.

Zone valves are the individual valves that operate a group of sprinklers or drip emitters. Typically one zone valve is turned on at a time, and controls the irrigation in a specific area of your garden. Whenever one of the irrigation zone valves is told to open by the controller, the controller also signals the master valve to open - the master valve acts like a back up valve, or a fail-safe valve. The purpose of the master valve is to shut off the water to the irrigation system when none of the zone valves are operating.

The image below shows a master valve operating connected to Zone 12 on a Hunter HC controller.

- Water main
- ◆ Master valve (optional)
- ◆ Solenoid Valves
- Water to zones
- Common wires
- @ 24V AC plug pack

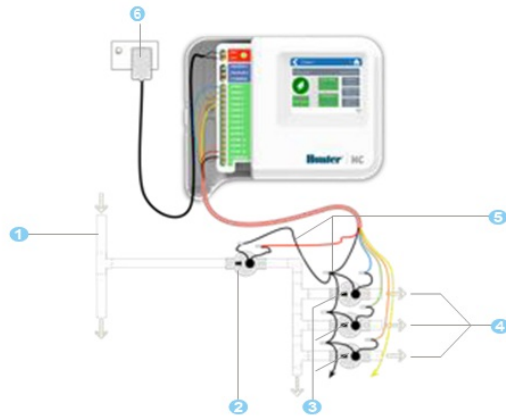

Different Hydrawise-Ready controller models have different options when selecting a master valve. With a Hunter HC controller, any one of your ordinary zones can be configured to act as a master valve, with all other Hydrawise-Ready controller models there is a dedicated master valve.

The master zone is configured on the Zones & Schedules page underneath your list of irrigation zones as highlighted in the image below.

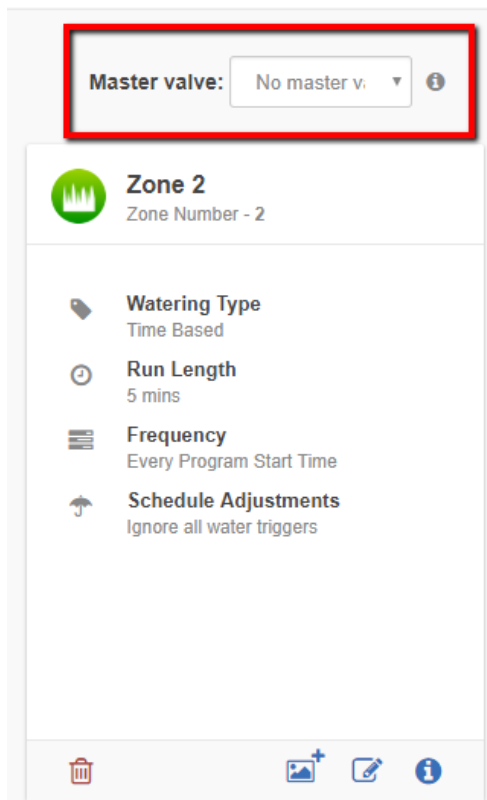

## Configuring Master Valve - PRO-HC

With the Pro-HC, setting the master valve (MV) is similar. All you need to do is select whether you have a MV as shown below.

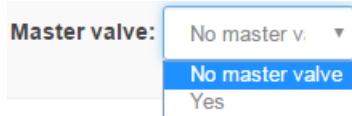

Master valve: No master v. ▾  
No master valve  
Yes

You no longer have to select which zone the MV is connected to, as the option will be different depending on the controller you select when setting up your controller for the first time.

Initially there is no master valve configured.

## Configuring Master Valve - HPC-FP (Panel for PC-400 controller)

The default is for all stations to have the master valve/pump start circuit ON. The master valve/pump start can be set **ON** or **OFF** by station, regardless of which program the station is assigned.

Please follow the steps for initializing the P/MV for each zone.

1. Click the  icon for the zone in "**zones and schedules**"
2. Click **Next** three times to enter the advanced section or programming.
3. You can now choose either of the following:
  1. Use **Global Master Valve Setting** (Turns the P/MV circuit ON)
  2. Use **Disable Master Valve** (Turns the P/MV circuit OFF)
- 4.

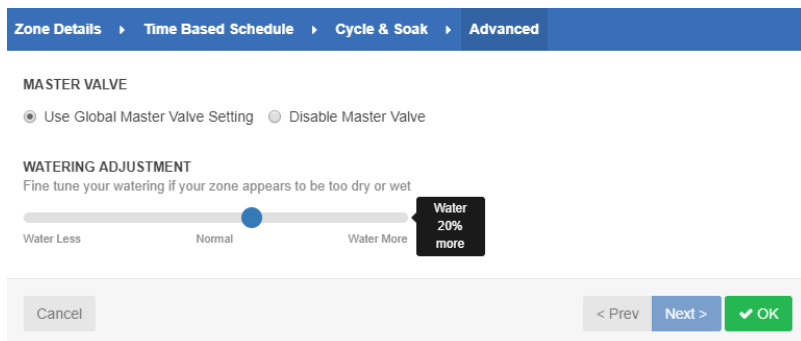

Zone Details ▶ Time Based Schedule ▶ Cycle & Soak ▶ **Advanced**

MASTER VALVE

Use Global Master Valve Setting  Disable Master Valve

WATERING ADJUSTMENT  
Fine tune your watering if your zone appears to be too dry or wet

Water Less Normal Water More **Water 20% more**

Cancel < Prev Next > OK

## Configuring Program Start Times

Your controller's watering Program Start Times specify when your controller is permitted to do any watering. If multiple zones are using the same Program Start Time, then they will be started in sequence (only one zone can run at a time).

To add a program start time, navigate to the Zones & Schedules page in your Hydrowise

account and click on Add Watering Time.

**Start Time:** Enter the time for this Program Start Time.

**Watering Type:** Choose the watering type for this Program Start Time. For example, choose odd or even weeks.

**Watering Days:** Choose which days this Program Start Time applies to. For example, choose odd or even days, or select specific days of the week.

The screenshot shows a configuration form with a blue header bar containing 'Set Time' and 'Select Zones'. Below the header, there are three sections: 'START TIME' with a text input field containing '05:00 AM'; 'WATERING TYPE' with a dropdown menu set to 'Normal watering time (every week)'; and 'WATERING DAYS' with a dropdown menu set to 'Selected Days of the week' and a row of seven circular buttons labeled 'S', 'N', 'M', 'T', 'W', 'TH', 'F'. At the bottom, there are three buttons: 'Cancel', '< Prev', and 'Next > OK'.

Then select the zones to which this Program Start Time applies. Either apply it to all zones or select from a list of zones or [Preconfigured Watering Schedules](#).

## Configuring Preconfigured Schedules

Preconfigured Watering Schedules allow you to group together zones with identical watering properties.

Each Preconfigured Watering Schedule determines how long a group of zones will run and how the schedule should be modified based on your local weather. Zones will water only at your defined [Program Start Times](#).

To add a preconfigured watering schedule, navigate to the Zones & Schedules page in your Hydrowise account and click on Add Watering Schedule.

**Schedule Name:** Give the schedule a name.

**Run Time:** Choose how long each irrigation zone associated with this Preconfigured Watering Schedule will run.

**Run Frequency:** Choose how often each irrigation zone associated with this Preconfigured Watering Schedule will run.

**Schedule Modification:** Select how the watering schedule for this Preconfigured Watering Schedule is modified based on temperature and rainfall. Note: if you apply this watering schedule to a Smart (ET) Watering zone, the schedule modification is not used.

## Viewing Preconfigured Watering Schedules

You can see all your preconfigured watering schedules on the Zones & Schedules page.

If your controllers are managed by a contractor, you may also see preconfigured watering schedules that your contractor has created. These will have a group symbol next to them as highlighted below. You can use these preconfigured watering schedules but you can't edit or delete them – only the contractor can do that.

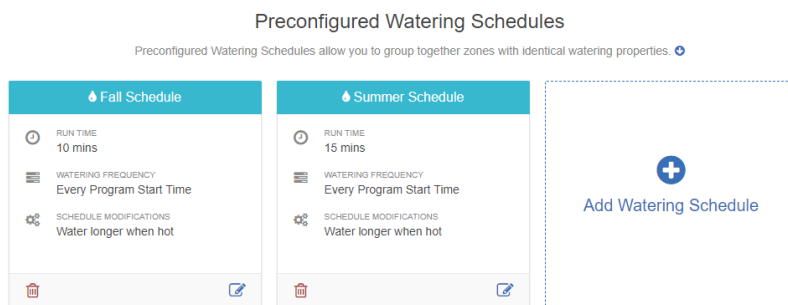

# Account - Run Length and Frequency

If you choose to enter the time and frequency for each of the zones, the following fields are available:

Time and Frequency	
<b>Watering Length:</b>	The number of minutes this zone will run for each time.
<b>Watering Frequency:</b>	Choose how often to water the zone. The most common is Every Program Start Time.
	Choose how to adjust the watering time based on your



Please view the steps and screenshots to access this feature:

Click on "**Zones and Schedules**" from the home dashboard.

1. Select the  box for the station (zone) that you will need to edit.
2. Select "**Next**" in the zone details
3. Enter "**watering length and/or frequency**". Select "**OK**" to save.

### STEP 1

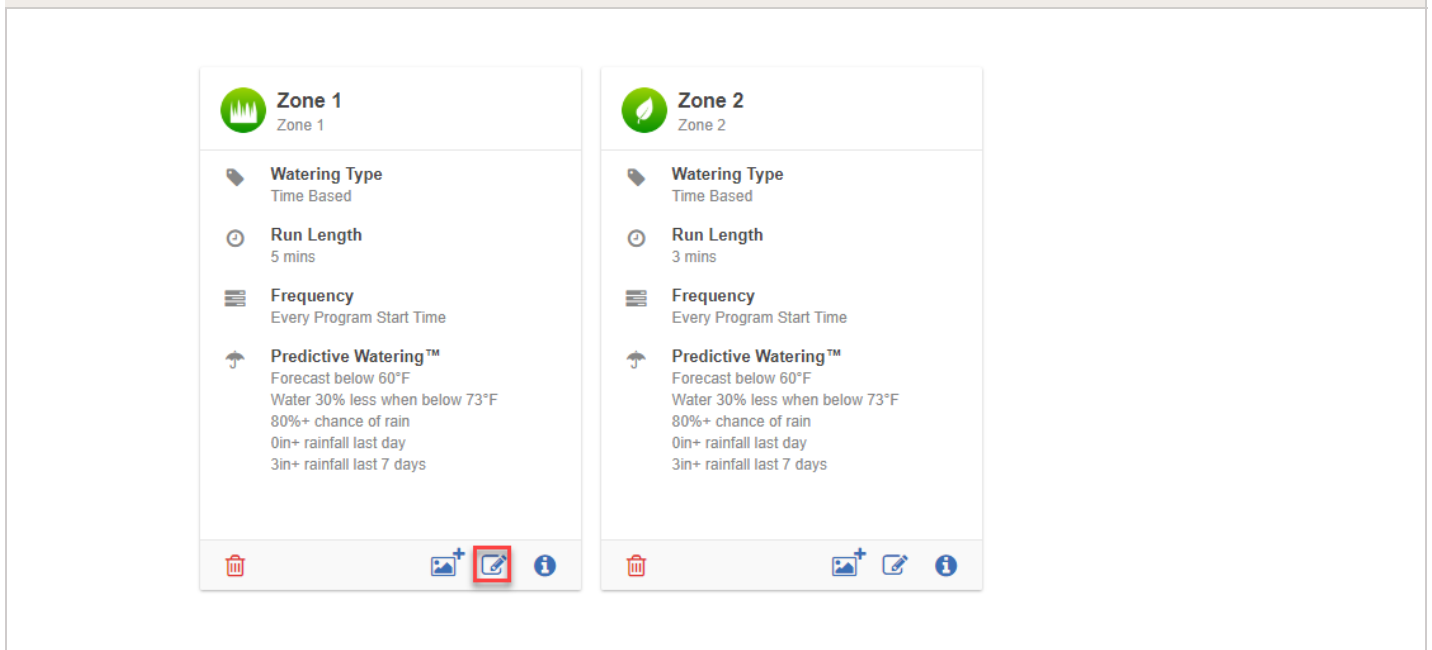

### STEP 2

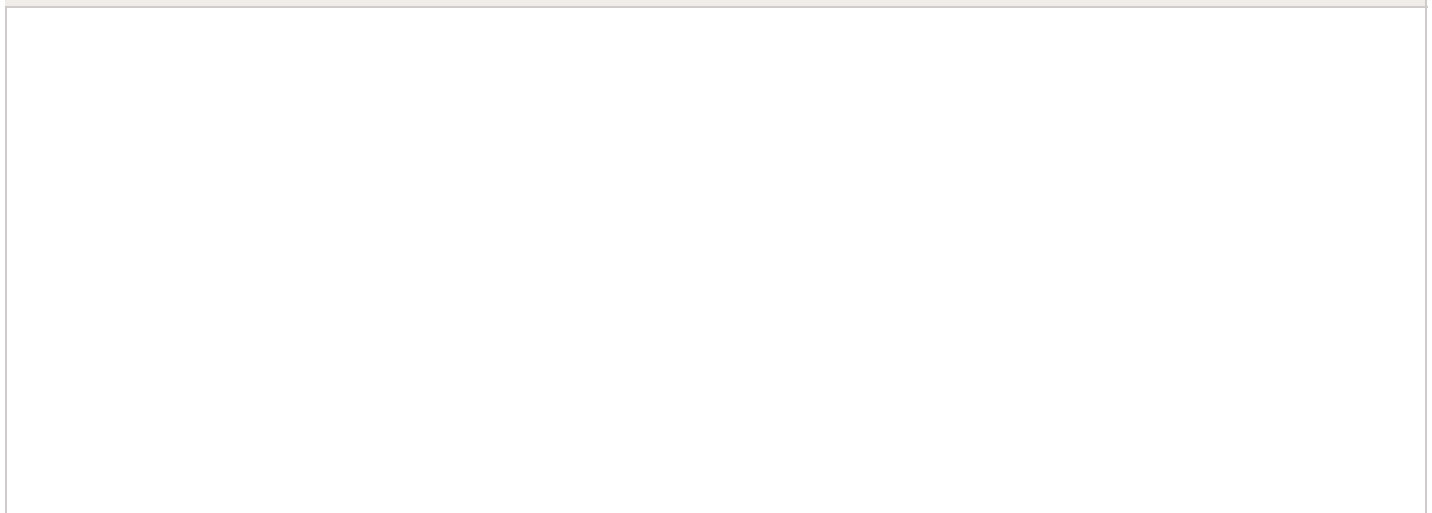

**Zone Details** ▶ **Time Based Schedule** ▶ **Cycle & Soak** ▶ **Advanced**

**Zone Name**  
Assign a name for this irrigation zone

Zone 1

**Zone Number**  
Choose the zone number that this zone is wired to on your Hunter controller

Zone 1

**Zone Icon**  
Choose the icon you want to see on the dashboard for this zone

**Watering Type**  
 Time Based Schedule  
 Smart (ET) Schedule  
 Virtual Solar Sync™  
 Water at a specified frequency (eg. every 1 week) and adjust schedule based on temperature and rainfall

Cancel   < Prev   **Next >**   ✓ OK

### STEP 3

**Zone Details** ▶ **Time Based Schedule** ▶ **Cycle & Soak** ▶ **Advanced**

**Watering Type**  
 Enter Time and Frequency below  
 Use a Preconfigured Watering Schedule

**Watering Length**  
The number of minutes this zone will run for each time

5 minutes

**Watering Frequency**  
Choose how often this zone should run

Every Program Start Time  
 Interval Based Watering

**Predictive Watering™**  
Adjust watering based on the following triggers

**Don't water when:**

- Forecast below 60°F
- Wind above 62mph
- 3in+ rainfall last 7 days
- 80%+ chance of rain
- 0in+ rainfall last day

**Adjust watering:**

- Water 30% less when below 73°F
- Water longer when hot
- Water more often when hot

Cancel   < Prev   **Next >**   ✓ OK

# Account - Watering Start Times

# And Water Days

**Watering Start Times** are the specified times when your controller is permitted to water. Watering will not occur with no start times even if run time are added to all the zones.

## Watering Start Time

Please view the steps and screenshots to access this feature:

Click on "**Zones and Schedules**" from the home dashboard. Scroll down to the bottom where you start times section. see the plus sign labeled **Add Watering Time**.

1. Click on the plus sign labeled **Add Watering Time**.
2. Choose the **start times, watering type, and watering days** then click "**next.**"
3. Choose "**All Zones or Selected Zones**" then click "**ok.**"

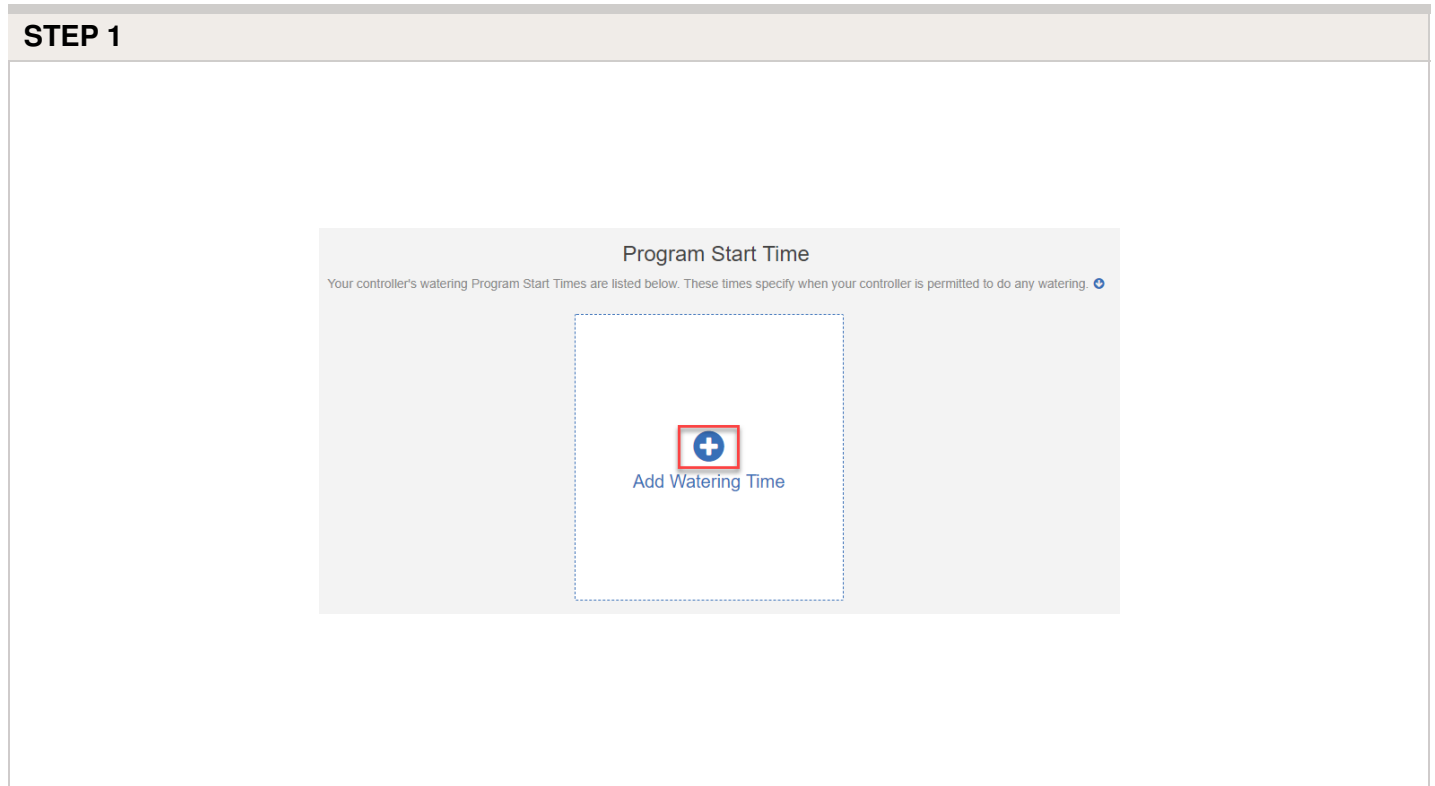

**Set Time** ▶ **Select Zone**

**Start Time**  
Enter the time for this Program Start Time

12:00 AM

**Watering Type**  
Normal watering time (every week)

Normal watering is permitted to start at this time

**Watering Days**  
Select the days of the week to water

Selected Days of the week

SN M T W TH F S

Cancel < Prev **Next >** ✓ OK

### STEP 3

**Set Time** ▶ **Select Zone**

**Select Zones**

Applies to all zones

This program start time can be used by all zones

Cancel < Prev **Next >** ✓ OK

## Watering Type Options:

<b>Normal watering time (every week)</b>	This watering time is used first when determining when the controller is permitted to run.
<b>Watering even weeks only</b>	This watering time is only used on even weeks. We use the ISO 8601 definition of even and odd weeks, where each week starts on a Monday. You can check if a particular date is on an even or odd week using an <a href="#">online tool</a> [14]. When watering on even weeks, you can choose to water on specific days of that week or only odd or even days of the week.

<b>Watering odd weeks only</b>	This watering time is only used on odd weeks. We use the ISO 8601 definition of even and odd weeks, where each week starts on a Monday. You can check if a particular date is on an even or odd week using an <a href="#">online tool</a> <sup>[14]</sup> . When watering on odd weeks, you can choose to water on specific days of that week or only odd or even days of the week.
<b>Low priority water</b>	Low-priority watering times are used when there are no Normal, Odd Week, or Even Week watering schedules available and a zone need to run. A low-priority watering time can be useful where you want the controller to insert extra watering cycles between your normal watering cycles on hot days. This watering type works in combination with <a href="#">How to Set Up "Water More Often When Hot."</a> <sup>[15]</sup>

## Watering Day Options:

<b>Select days of the week</b>	You can specify the days on which you want this program start time to be effective. <b>Note:</b> Blue means selected, so by default all days are selected. You can deselect a day by clicking on it and it will turn white.
<b>Even days</b>	Will only allow this program start time to start on even days of the month
<b>Odd days</b>	Will only allow this program start time to start on odd days of the month

<b>Applies to all zones</b>	This automatically applies the specified program start time to all zones. If you remove or add irrigation zones, they will automatically be applied to this program start time
<b>Selected zones</b>	This will only allow the selected zones to use this program start time. If you add more irrigation zones, you may be required to add them to this program start time if you want them to use this program start time.

**NOTE:** If multiple zones use the same Program Start Time, they will be started in sequence.

Remember that there are many variables that can affect your Program Start Times. To understand how each one works, spend some time looking at the different options and

settings to see how they affect your watering schedule. If you would like to know more about how **Watering Triggers** can affect your program start times, refer to these links:

[Water More Often When Hot](#) <sup>[15]</sup>

[Setting Watering Triggers](#) <sup>[16]</sup>

[Smart Watering Adjustment](#) <sup>[17]</sup>

[Configuring Watering Schedules](#) <sup>[18]</sup>

For further information, email us at [support@hydrowise.com](mailto:support@hydrowise.com) <sup>[19]</sup>. We're happy to help.

---

# Account - Controller Weather Stations

Setting your location allows your Hydrowise controller to adjust watering based on your local weather conditions.

**IMPORTANT:** Your weather forecasts and local weather stations are based upon your location so it is important to configure your location correctly in the application.

The chart below has the stations available based on the plan you have on your account.

Station Options	
<b>Personal Weather Stations</b>	Up to five can be selected on the Enthusiast plan
<b>Airport Weather Stations</b>	Up to one can be selected on a free Home Plan

## Virtual Weather Stations

Up to one can be selected on a free Home Plan

## Weather Stations

Your Enthusiast plan allows you to select up to 5 Weather Stations updated hourly. If you select multiple weather stations then your weather station readings are averaged out to give a higher degree of rainfall accuracy.





Closest Station 0.00 mi  
1943 Diamond St, San Marcos, CA  
92078, USA

27 Stations

 22 Personal Weather Stations  

 4 Free Airport Weather Stations  

 1 Free Virtual Weather Station  

Show weather stations not reporting temperature and rainfall

Please view the steps and screenshots to access this feature:

1. From the menu at the top right-hand corner of the screen, select **Weather Stations**.
2. Enter the location of your controller with full street address and click **Click arrow icon** to update.
3. Click on the most relevant weather station(s). To start using a station, press the **Select** button.

### STEP 1

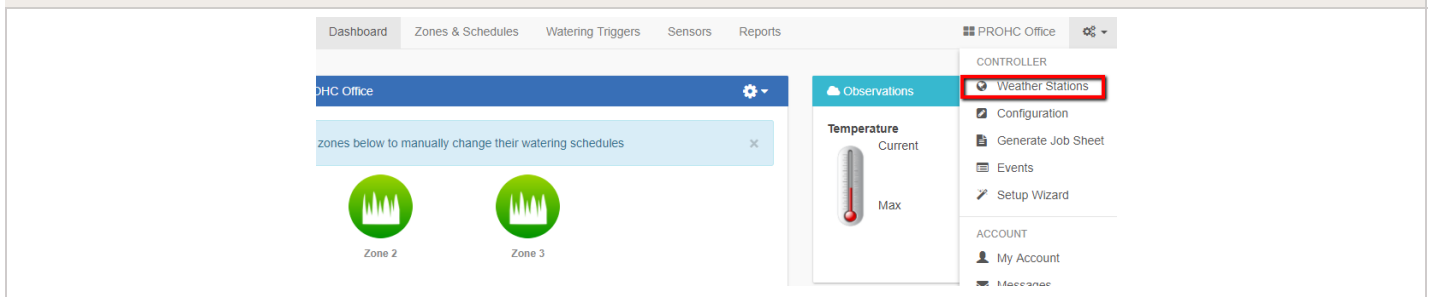

### STEP 2

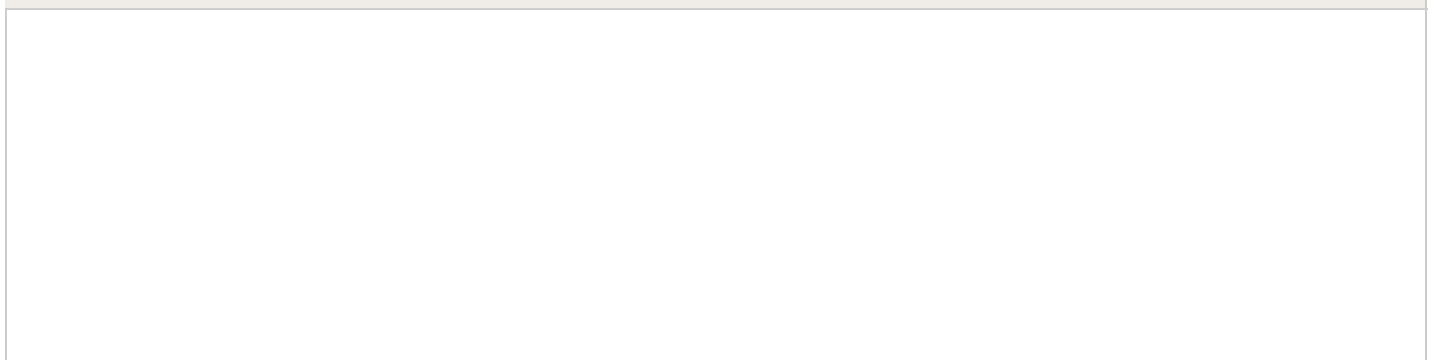

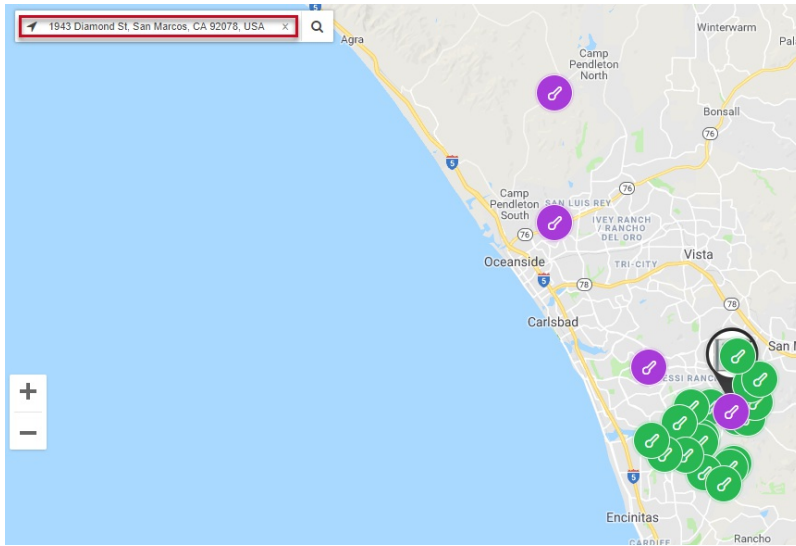

### STEP 3

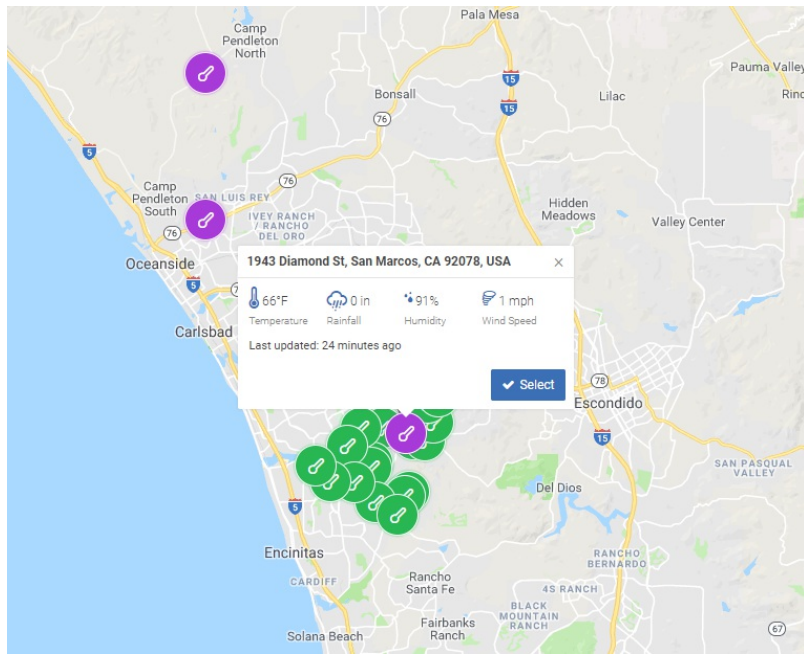

Information from the weather station(s) is used to determine whether to suspend watering (due to high local rainfall for the day or week) or water more (due to high current temperature).

If you have an Enthusiast Plan or higher [20], we recommend that you select three or more weather stations in your area to average out abnormalities in individual weather stations.



# Account - Water Triggers

Hydrawise uses local, real-time weather forecasting and the most accurate weather stations

available to fine-tune your irrigation system to current conditions. Water triggers are the settings in your Hydrawise software that can be adjusted based on your watering requirements.

You can configure watering triggers for either **Time Based watering, Smart (ET) watering or Virtual Solar Sync.**

## Time-Based Predictive Watering™

When using the time based watering type, you will have the following options listed below when setting up your zone:

### Trigger Options In Station Settings

**Predictive Watering™**  
Adjust watering based on the following triggers

Don't water when:

- Forecast below 60°F
- 80%+ chance of rain
- Wind above 9mph
- 0.5in+ rainfall last day
- 3in+ rainfall last 7 days

Adjust watering:

- Water 30% less when below 73°F
- Water longer when hot
- Water more often when hot

In addition to daily predictive watering adjustments you can specify monthly adjustments using the chart below

Month	Percentage
Jan	40
Feb	50
Mar	60
Apr	70
May	80
Jun	100
Jul	100
Aug	100
Sep	80
Oct	70
Nov	60
Dec	50

**Note:** Trigger will not be applied if box is unchecked (  ).

The timed based triggers can be accessed from the Water Trigger section on the dashboard. To configure your **Predictive Watering™** triggers click on Watering Triggers. You will see the options listed below:

### Water Triggers

### Predictive Watering™ Adjustments

Manage your watering based on weather forecasts. Choose which adjustments to apply when editing a zone.

The screenshot displays seven adjustable settings for predictive watering:

- Temperature Threshold:** "Don't water when today's forecast temperature is less than" with a slider set to 60 F.
- Temperature Adjustment:** "Water 30% less when today's forecast temperature is less than" with a slider set to 73 F.
- Temperature and Humidity Adjustment:** "Water 100% more when today's forecast temperature is above and humidity is below 100%" with a slider set to 90 F.
- Rain Chance Threshold:** "Don't water when the chance of rain is higher than" with a slider set to 80%.
- Wind Speed Threshold:** "Don't water when today's forecast wind speed is higher than" with a slider set to 9 mph.
- Smart Watering (Temperature):** "Use forecast temperature to predict smart watering" (toggle on).
- Smart Watering (Rainfall):** "Use forecast rainfall to predict smart watering" (toggle on).

### Weather Station Adjustments

Automatically stop your watering based measurements from your weather stations

The screenshot displays two adjustable settings for weather station measurements:

- 24hr Rainfall Threshold:** "Don't water when the last 24hr rainfall is higher than" with a slider set to 0.5 in.
- 7-day Rainfall Threshold:** "Don't water when the last 7 days rainfall is higher than" with a slider set to 3 in.

Time Based: Quick Reference Chart	
Trigger	Adjustment
Don't water when today's forecast temperature is less than..	(Slider Edit for Temperature)
Water <b>30% (Edit)</b> less when today's forecast temperature is less than	(Edit) + (Slider Edit for Temperature)
Water <b>100% (Edit)</b> more when today's forecast temperature is above and humidity is below <b>100%</b>	(Edit) + (Slider Edit for Temperature)
Don't water when the chance of rain is higher than	(Slider Edit for %)
Don't water when today's forecast wind speed is higher than	(Slider Edit for Wind)
Don't water when the last 24 hr rainfall is higher than	(Slider Edit for Rain)
Don't water when the last 7 days rainfall is higher than	(Slider Edit for Rain)

For more information on the following triggers below for Time Based Watering, click on the links:

[Water more often when hot](#) [21]

## Smart (ET) Watering

Using forecast evapotranspiration helps to predict the right watering schedule for your zones, giving you a more accurate picture of when the zones will next run.

You can choose whether to use the forecast temperature to predict smart (ET) watering, and whether to use forecast rainfall to delay smart (ET) watering. Watering Schedules will be estimated up to 30 days from today based on forecast and historical temperatures and rainfall. The predicted schedules will be progressively updated each day based on actual weather conditions and new forecasts.

Your watering schedule is updated based on actual weather conditions shortly before your first Program Start Time each day.

You can view the watering adjustments for Smart Watering by clicking [here](#) [23].

For more information on how Time Based Watering works compared to Smart Watering please check out our video guide [here](#) [24].

### Trigger Options In Station Settings

**Predictive Watering™**  
Your schedule is adjusted each day using ET from your weather stations. In addition to ET adjustments you can use the following Watering Triggers:

Don't water when:

- Forecast below 60°F

Predict watering using:

- Forecast ET
- Forecast rainfall

In addition to daily ET adjustments you can specify a monthly adjustment using the chart below

Month	Percentage
Jan	100
Feb	100
Mar	100
Apr	100
May	100
Jun	100
Jul	100
Aug	100
Sep	100
Oct	100
Nov	100
Dec	100

**Note:** Trigger will not be applied if box is unchecked (  ).

The Smart (ET) Watering triggers can be accessed from the Water Trigger section on the dashboard. To configure your **Predictive Watering™** triggers click on Watering Triggers. You will see the options listed below:

### Water Triggers

## Predictive Watering™ Adjustments

Manage your watering based on weather forecasts. Choose which adjustments to apply when editing a zone.

The interface displays several adjustable settings for predictive watering:

- Temperature-based adjustments:**
  - Don't water when today's forecast temperature is less than **60 F**.
  - Water 30 % less when today's forecast temperature is less than **73 F**.
  - Water 100 % more when today's forecast temperature is above **90 F** and humidity is below 100%.
- Rain and Wind-based adjustments:**
  - Don't water when the chance of rain is higher than **90 %**.
  - Don't water when today's forecast wind speed is higher than **62 mph**.
- Smart Watering options:**
  - Use forecast temperature to predict smart watering (On/Off).
  - Use forecast rainfall to predict smart watering (On/Off).

## Weather Station Adjustments

Automatically stop your watering based measurements from your weather stations

The interface displays two rainfall-based adjustments:

- Don't water when the last 24hr rainfall is higher than **0.5 in**.
- Don't water when the last 7 days rainfall is higher than **2 in**.

## Smart (ET) Watering: Quick Reference Chart

Trigger	Adjustment
Uses forecast temperature to predict smart watering	(On/Off)
Uses forecast rainfall to predict smart watering	(On/Off)

## Virtual Solar Sync™

When using the Virtual Solar Sync type, you will have the following options listed below when setting up your zone:

### Trigger Options In Station Settings

Trigger Options In Station Settings

### Predictive Watering™

Adjust watering based on the following triggers

#### Don't water when:

- Forecast below 60°F
- 80%+ chance of rain
- 3in+ rainfall last 7 days
- Wind above 9mph
- 0.1in+ rainfall last day

In addition to daily ET adjustments you can specify a monthly adjustment using the chart below

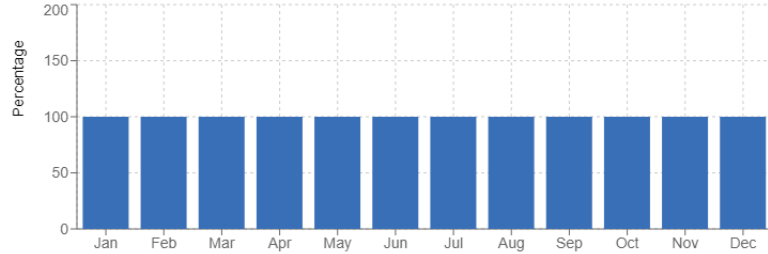

**Note:** Trigger will not be applied if box is unchecked (  ).

The VSS triggers can be accessed from the Water Trigger section on the dashboard. To configure your **Predictive Watering™** triggers, click on Watering Triggers. You will see the options listed below:

### Water Triggers

#### Predictive Watering™ Adjustments

Manage your watering based on weather forecasts. Choose which adjustments to apply when editing a zone.

Don't water when today's forecast temperature is less than **60 F**

Water 30% less when today's forecast temperature is less than **73 F**

Water 100% more when today's forecast temperature is above **90 F** and humidity is below **30%**

Don't water when the chance of rain is higher than **80%**

Don't water when today's forecast wind speed is higher than **9 mph**

Use forecast temperature to predict smart watering

Use forecast rainfall to predict smart watering

#### Weather Station Adjustments

Automatically stop your watering based measurements from your weather stations

Don't water when the last 24hr rainfall is higher than **0.1 in**

Don't water when the last 7 days rainfall is higher than **3 in**

### Virtual Solar Sync: Quick Reference Chart

(Slider Edit for

Don't water when today's forecast temperature is less than	Temperature)
Don't water when the chance of rain is higher than	(Slider Edit for %)
Don't water when today's forecast wind speed is higher than	(Slider Edit for Wind)
Don't water when the last 24 hr rainfall is higher than	(Slider Edit for Rain)
Don't water when the last 7 days rainfall is higher than	(Slider Edit for Rain)

---

# Account - Running Zone(s) Manually

You can run an irrigation zone on demand from from your web browser or from your iPhone/Android app. For running manual from the controller, see article [here](#) <sup>[25]</sup>.

## Manual Single Station

Please view the steps and screenshots to access this feature:

1. From the home dashboard, click on the **"zone icon."**
2. Select the **"play button."**
3. Select a **"customer length or normal run length."**
4. Click **"run now."**

## STEPS 1-2

The screenshot shows the 'Watering Schedule for Diamond Street Controller' interface. At the top, there is a blue header with a gear icon and a dropdown arrow. Below the header is a light blue information box that says 'Info Click on any of your zones below to manually change their watering schedules'. The main area features three green circular icons representing different zones: 'Front Grass', 'Lowes', and 'Back Drip'. A tooltip is visible over the 'Front Grass' icon, displaying 'Next Run' (Wed, 26th Sep 5:00am), 'Length' (5 minutes), and 'Last Water' (4 hours 50 minutes ago). Below the zones, there are weather forecasts for Tuesday (73°F, Partly Cloudy), Wednesday (77°F, Sunny), and Thursday (81°F, Partly Cloudy). A red box highlights a play button icon in the interface.

## STEPS 3-4

The screenshot shows a dialog box titled 'Manually Start a Zone'. The main question is 'How long would you like to run **Front Grass** for?'. There are two options: 'Normal length' (selected) and 'Custom length' with a gear icon. Below the options, it says 'Run Front Grass for its normal watering length'. A green 'Run Now' button with a checkmark is prominently displayed. At the bottom right, there is a 'Cancel' button.

## Manual All Stations

1. From the home dashboard, click on the "gear with drop down arrow."
2. Select the "run all zones."
3. Select a "customer length or normal run length."
4. Click "run now."

## STEPS 1-2

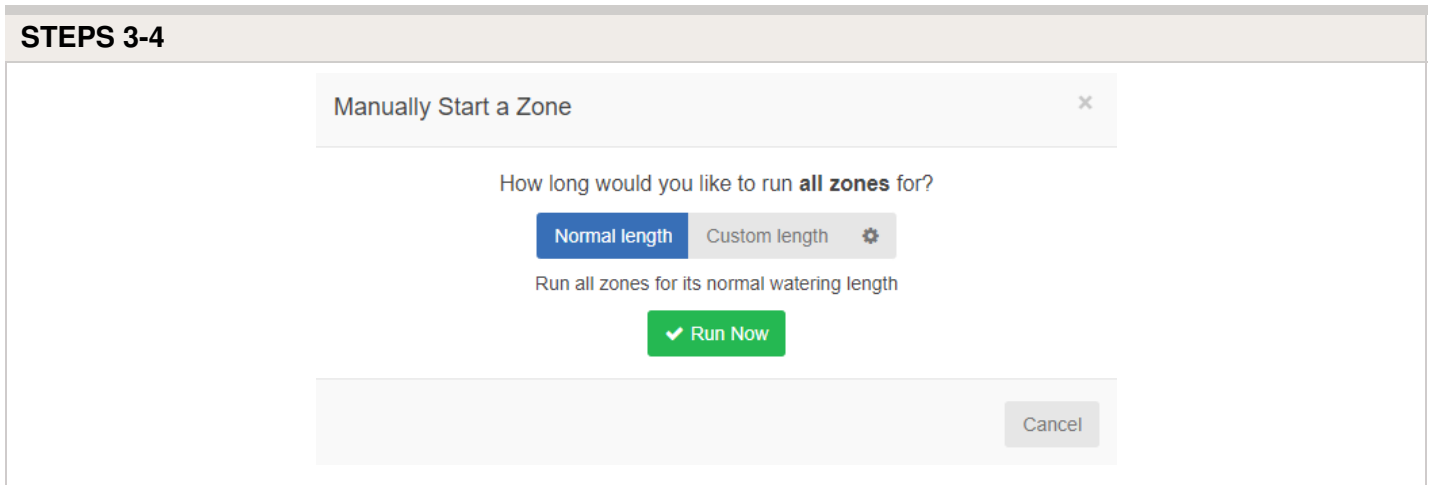
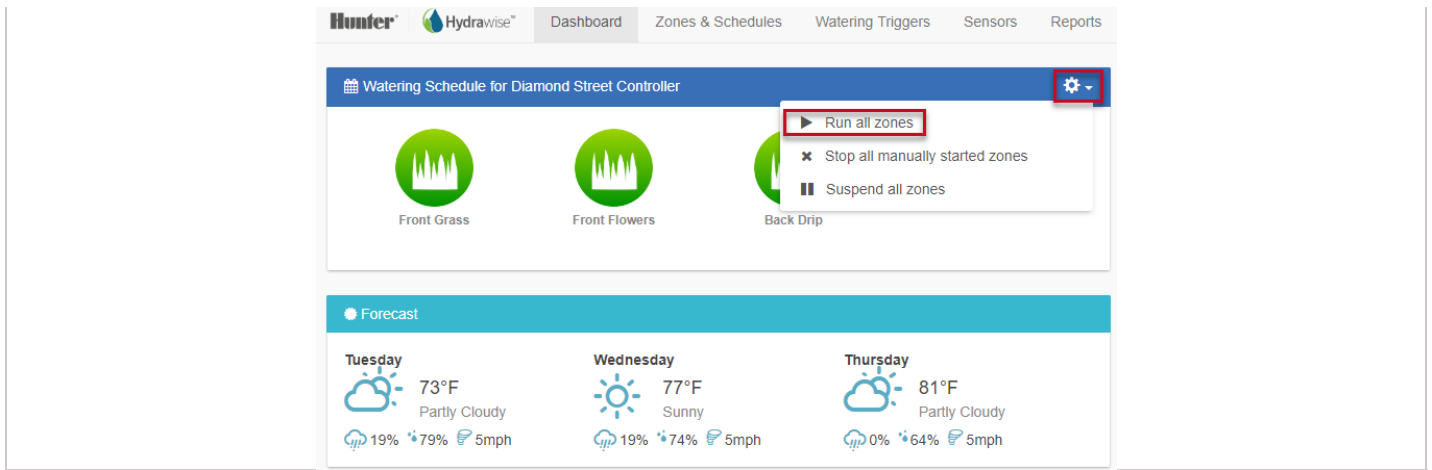

**TIP:** To stop a zone that is currently running, click the **Stop**  button on your Dashboard.

## Accounts - Reports

You can access reports for your controllers by selecting Reports from the main menu and selecting the three lines at the bottom for the mobile version. Use the settings at the top of the screen to:

- Change the date range for the report
- Clear all report data
- Download a report to Excel
- Refresh a report



- View all report data

**REPORT RANGES**

Below you will find all the different report names and description of each.

<b>Schedule</b>	
Report Name	Description
Watering Schedule	Shows the scheduled watering time for each zone. You can hover over each schedule to see more details about the planned watering.
Watering History (Actual)	Shows actual completed watering time for each zone. You can hover over each watering time to see more details about the watering.

<b>Weather</b>	
Report Name	Description
Weather Forecast	Show the historical weather forecast plus the next 3 days, forecast. You controller will use this forecast to adjust your watering schedule.

Weather Station Temperatures	Shows daily maximum temperatures for each weather station to which the controller is subscribed. You can click on the weather station names at the bottom of the report to show their information in the report or exclude it.
Weather Station Rainfall	Shows daily rainfall for each weather station to which the controller is subscribed. You can click on the weather station names at the bottom of the report to show their information in the report or exclude it.
Weather Station Wind Gust	Shows wind gusts for each weather station to which the controller is subscribed. You can click on the weather station names at the bottom of the report to show their information in the report or exclude it. Hover over any wind gust bar to see further information.
Evapotranspiration (ET)	Shows daily evapotranspiration for each weather station to which the controller is subscribed. You can click on the weather station names at the bottom of the report to show their information in the report or exclude it.

<b>Water Usage</b>	
Report Name	Description
Water Saving	Shows the estimated water saving for your controller over the last 7 days. During cold weather you would expect to see this percentage increase due to reduced watering. During hot weather you would expect to see this percentage decrease (and go negative) as the controller increases watering.

Flow Meter Measurements	If you have a flow meter installed, this report shows reported flow for each of your controller's zones.
Total Water Usage	Shows daily water usage as recorded by each flow meter. Also shows minimum and maximum water usage for any flow meter across the period as well as the average and total water usage. You can click on the flow meter names at the bottom of the report to show their information in the report or exclude it. Hover over any flow meter bar to see how many zones were active at the time.
Flow Rates (per minute)	If you have a flow meter installed, this report shows instantaneous flow rates each time the controller records flow. Hover over any dot to see the flow rate and number of zones active at the time.
Sensor Levels	If you have a rain sensor, moisture sensor or any other 'level' based sensor configured this report will show the historical status of your sensor (open or closed).
Smart Water Balance	Shows the irrigation balance for each zone on a given day. Also shows the minimum and maximum irrigation balance over the report period. You can click on the zone names at the bottom of the report to show their information in the report or exclude it. Hover over the graph to see information on evapotranspiration, rainfall and irrigation amounts.
Virtual Solar Sync	Shows the Solar Sync adjustment by a date and percentage.

<b>Diagnostics</b>	
Report Name	Description
	150 – 449mA = 1 solenoids 450 – 749mA = 2 Solenoids

Solenoid Load	750 + = 3 solenoids Greater than 880 mA and the controllers will trip out on the overload.
---------------	---

Historical Weather	
Report Name	Description
<b>Monthly Evapotranspiration and Rainfall</b>	Shows the historical ET and rainfall in your area. This data is based on a 12 year average
<b>Monthly Temperature and Rainfall</b>	Shows the historical temperature and rainfall in your area. This data is based on a 12 year average.

---

# Account - Alerts

In this section, we will cover how to assign an alert, understanding alerts and a description of each of the alerts.

## Assigning the Alert

Please view the steps and screenshots to access this feature:

1. Click on **three gears** on the upper right next to the controller name.
2. Add **new alert**.
3. Choose a **alert name, alert type, and water usage percentage** (flow related only).
4. Choose which **controller** should be linked to the alert.
5. Finally, choose from the following options:
  - Option to add the event to the event log for tracking
  - Where to send in-app notifications
  - Assign a phone number for SMS notification
  - Suspend a zone for days or weeks until issue repaired

**STEP 1**

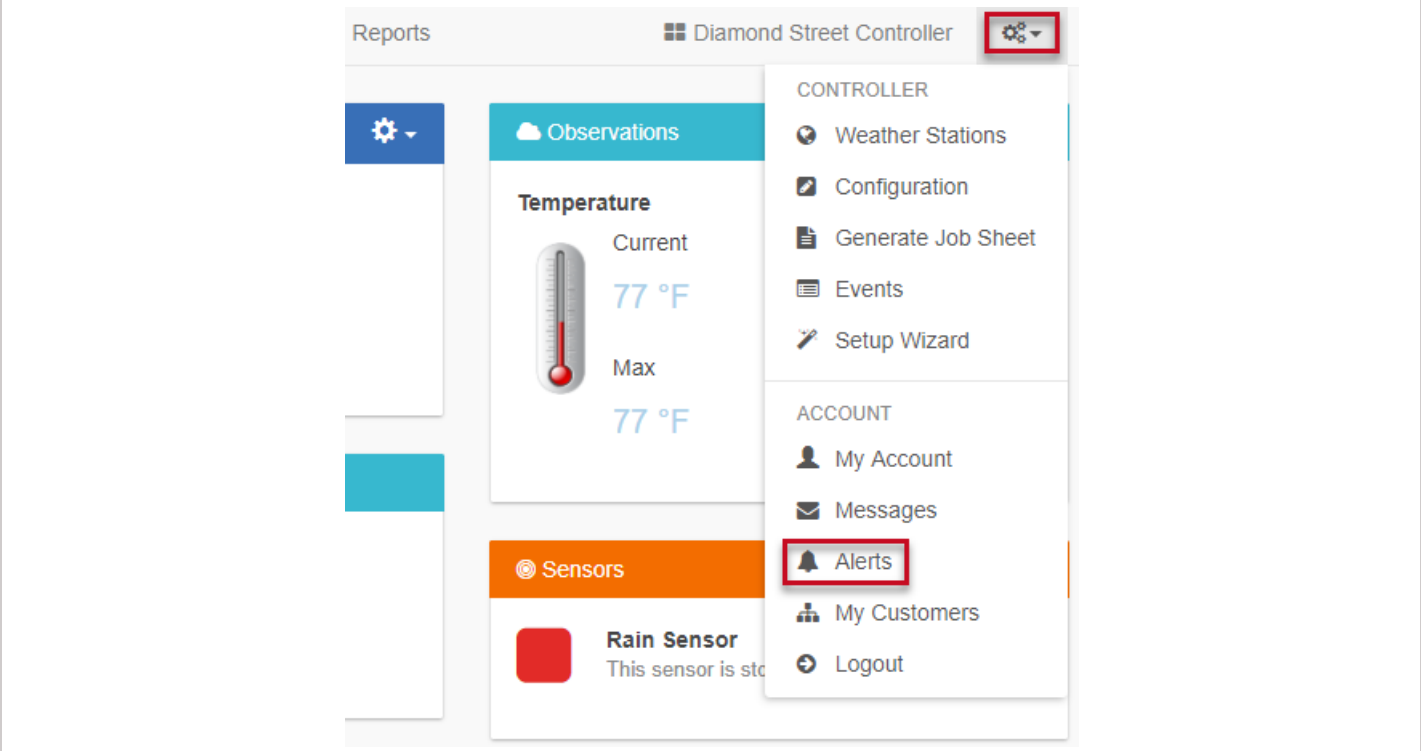

The screenshot shows a web interface for a controller named "Diamond Street Controller". At the top right, there is a settings icon (three gears) highlighted with a red box. A dropdown menu is open, showing various options. Under the "CONTROLLER" section, there are options for Weather Stations, Configuration, Generate Job Sheet, Events, and Setup Wizard. Under the "ACCOUNT" section, there are options for My Account, Messages, Alerts (highlighted with a red box), My Customers, and Logout. The main content area shows "Observations" with a temperature of 77°F and "Sensors" with a "Rain Sensor" that is currently stopped.

**STEP 2**



This section is currently empty, representing the next step in the process.

## Alerts

Alerts allow you to be notified of potential issues with your controller wiring, valves, pipes or Hunter controller



Add new alert

### STEP 3

#### Edit Alert ×

**Alert Name** ▶ **Applies To** ▶ **Actions**

**Alert Name**  
High Flow

**Alert Type**  
High water usage for a zone ▼

Zone's water usage rate is higher than the  %  
previous time this zone ran

### STEP 4

Edit Alert ×

**Alert Name** ▶ **Applies To** ▶ **Actions**

**Applies To**

Selected controllers or sensors ▼

Choose at least 1 item from the lists below

**Controllers**

- Carioca Court
- Diamond Street Controller
- 8 Dutchess lane

**Sensors**

- Rain Sensor

⇄

**STEP 5**

Edit Alert ×

**Alert Name** ▶ **Applies To** ▶ **Actions**

Add event to the event log  
Add this alert to the controller's event log

Send App notification

Bernie ▼

Send Test

Send a notification to each iOS and Android device

Send SMS/Text notification

Send Test

Send an SMS/Text notification to this number. You must include your country code at the start (eg. +1 for US)

Suspend the zone

Days ▼

# Understanding Alerts:

Below is a list of different alerts and information about what each alert means.

Alert	Description
<b>High water usage for zone</b>	Zone's water usage rate is higher than the previous time this zone ran.
<b>Low water usage for zone</b>	Zone's water usage rate is lower than the previous time this zone ran.
<b>High water usage with no zone running</b>	High water usage detected when no zones are active.
<b>High water usage over the last hour with no zones running</b>	Water usage over the last hour when no zones are active is greater than your trigger.
<b>Interrupted water usage at any time</b>	Water usage at any time is less than your trigger (averaged over 15 min).
<b>Interrupted water usage over last hour</b>	Water usage over the last hour is less than your trigger.
<b>Wiring short (high current) to your solenoid</b>	High solenoid current caused by faulty wiring or faulty solenoid valve.
<b>Broken wire to your solenoid</b>	No solenoid current caused by broken wiring or nonexistent solenoid valve.

## How each alert works:

Alert	How it works
<b>High water usage for zone</b>	If a zone has a water rate higher than the previous time it was scheduled and no changes have been made to the watering length, you can set a % to give you an alert (as there might be a leak somewhere when this zone runs).
<b>Low water usage for zone</b>	This alerts works similar to the above. However, alerts for low water usage advise you if there is a blockage or a potential leak minimizing the water output through the solenoid.
<b>High water usage with no zone running</b>	This will notify you if water flow is being measured while no zone is active. If you use this alert, make sure you make room for residual water that can pass back and forth through your flow meter, which can give false alerts. We recommend setting this between 5-10 liters.
<b>High water usage over the last hour with no zones running</b>	This measures slow water leaks that occur over a period of one hour, so you can be notified if a zone has been leaking "x" amount of water in the last hour.



<b>Interrupted water usage at any time</b>	A threshold can be set in liters. If usage falls below the threshold, an alert is triggered.
<b>Interrupted water usage over last hour</b>	This alert works similar to the above alert, but the difference is that it measures usage hourly. Note: This alert is useful if you expect to have water flow every hour.
<b>Wiring short (high current) to your solenoid</b>	On average, a solenoid can use 200-400 mAh. If you have a master valve, this value can change to 300-500 mAh. You will receive an alert if our controller measures a spike, as there could be a fault in wiring or the solenoid itself.
<b>Broken wire to your solenoid</b>	This alert is triggered when no current is measured when a zone runs.

**NOTE:** The low-current alert is generated after the zone stops watering (i.e., we wait for the entire cycle to see if there is any current). The high-current alert stops the zone at the end of the (aborted) cycle. The same is true for water-usage alerts (we check water usage at the end of the cycle against the previous time the zone ran).

---

# Account - Controller Configuration

To change the configuration of your controller, select **Configuration** from the menu in the top right hand corner.

Please view the screenshot below to access this feature:

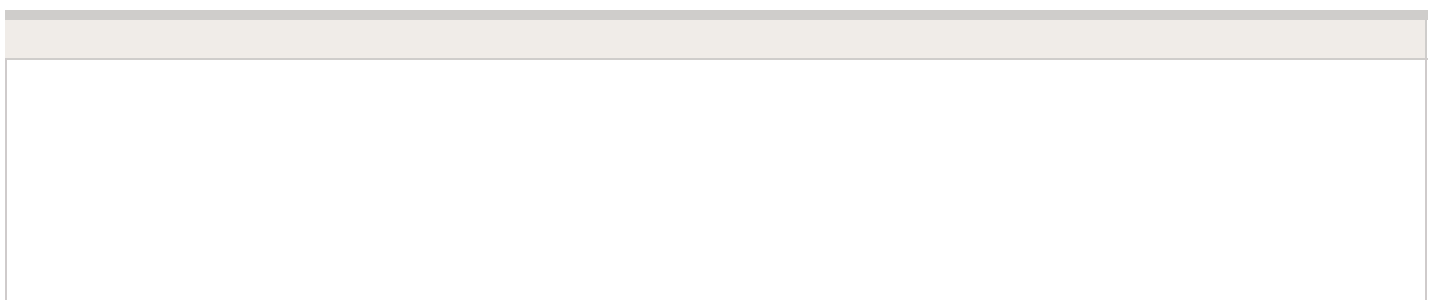

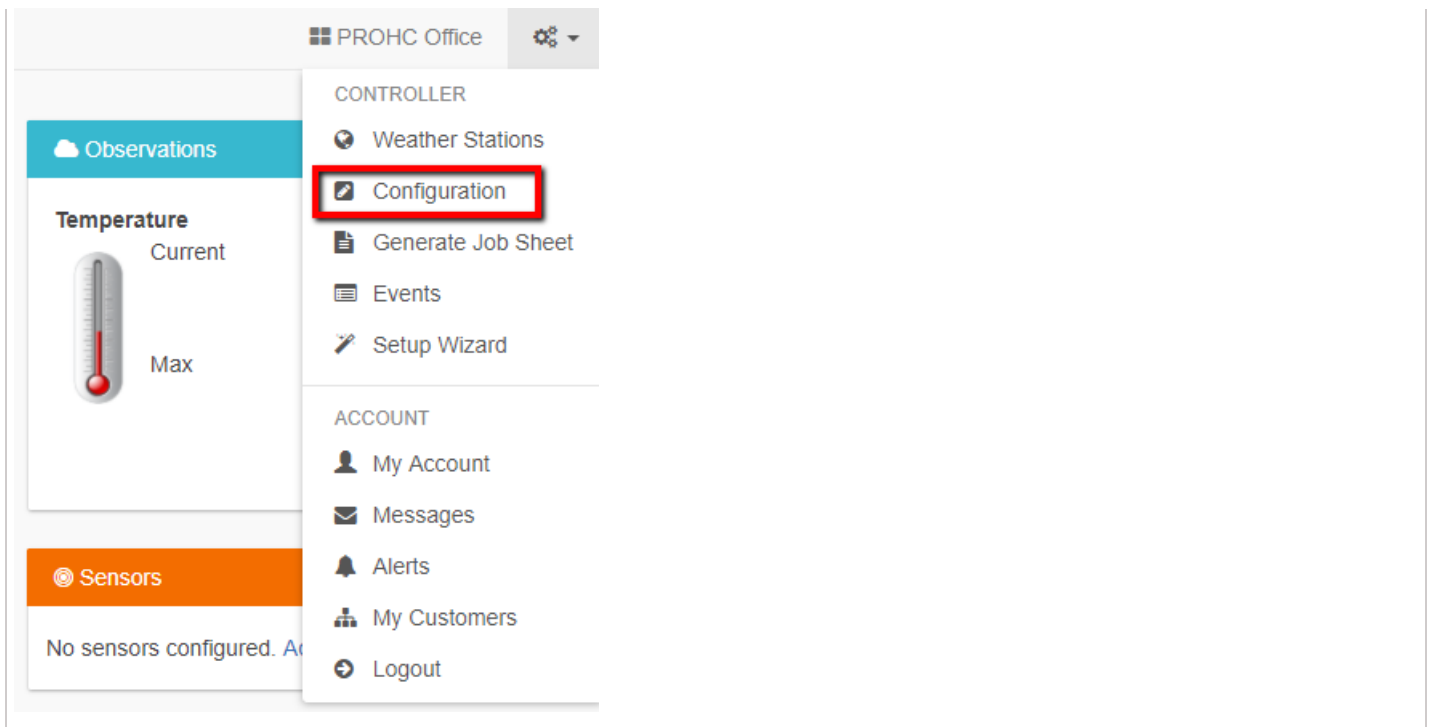

## Controller Settings

Configuration Options	
<b>Controller Name</b>	The name of your controller
<b>Serial Number</b>	The controller's serial number. Click 'Remove Serial' to remove the serial number and replace it with another physical controller
<b>Notification Email</b>	The email address notifications are sent to when the controller is offline, or Hydrawise needs to contact you (for example when your subscription plan is about to end)
<b>Notify</b>	The amount of time that your controller is offline for before we notify you
<b>Units</b>	The units used for reports, alerts and elsewhere in the app
<b>Inter Zone Delay</b>	The number of seconds to insert between each zone watering when calculating scheduled
<b>Master Valve Delay</b>	The minimum number of seconds that the master valve should be active before any zone starts
<b>Hide password</b>	If set to yes, this will hide your wireless password on the controller. If your controller is in a publicly accessible area we recommend you hide your password.

## Controller Settings Page

### Controller Settings for My Controller

<b>CONTROLLER</b> <ul style="list-style-type: none"><li>NAME: Hunter Industries</li><li>SERIAL NUMBER: v1r14563 <a href="#">Remove Serial</a></li><li>STATUS: Linked</li><li>MODEL: HC 6 Zone Controller</li><li>INSTALL DATE: Mon, 19 Sep 16 02:07:37 +0000</li><li>SOFTWARE</li></ul>	<b>OFFLINE NOTIFICATIONS</b> <ul style="list-style-type: none"><li>NOTIFICATION EMAIL: anthony+4@hydravise.com</li><li>NOTIFY: After no contact for 1 day</li></ul>
<b>INTERNET SETTINGS</b> <ul style="list-style-type: none"><li>OFFLINE MODE</li><li>HIDE WIFI PASSWORD: No</li><li>DISABLE LOCAL ACCESS: No</li></ul>	<b>REGIONAL SETTINGS</b> <ul style="list-style-type: none"><li>TIMEZONE: America/Los_Angeles</li></ul>
	<b>VALVE DELAYS</b> <ul style="list-style-type: none"><li>INTER ZONE DELAY: 0 seconds</li><li>MASTER VALVE DELAY: 3 seconds</li></ul>

## Expansion Modules

This section you can see your expansion modules and when they last made contact. You can also add or remove expansion modules. Up to 2 expansion modules can be added to a single Hunter HC controller.

### Expansion Modules

Expansion modules expand your controller up to 36 zones

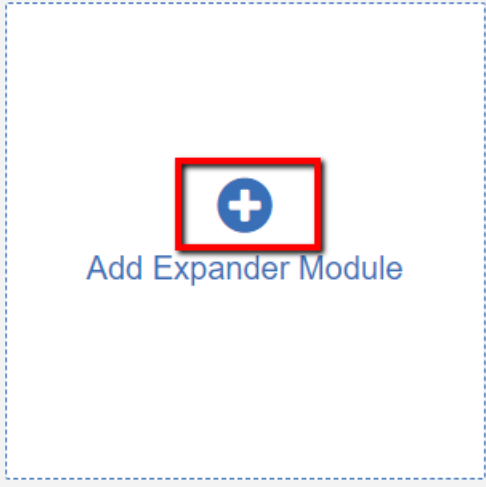

When you add an expansion module, you will need to give it a name and specify the ID number that you selected when setting up the module. This number needs to match the number at the physical expansion module as well.

Edit an expansion module ×

**Expansion Module Name**  
  
This is a name for the expansion module

**Expander ID**  
  
Each expander module has a selectable ID between 1 and 5. This must match the ID selected on the expander unit.

## Offline Water Adjustments

Offline water adjustments allow the controller to automatically adjust the amount of watering on a month- by-month basis if the controller is in an Offline mode (ie. if is not connected to the internet).

□

# Account - Account Details

## Account Details

Here you can change your password, change your plan and change your account visibility settings. By default, nobody else can see your account. However, if you want help from a Hydrawise contractor then you can choose to make your account visible to the contractor so that they can help you with configuration or troubleshooting.

1. Click the three gear settings icon in the top right hand corner to view **"My Account"**.

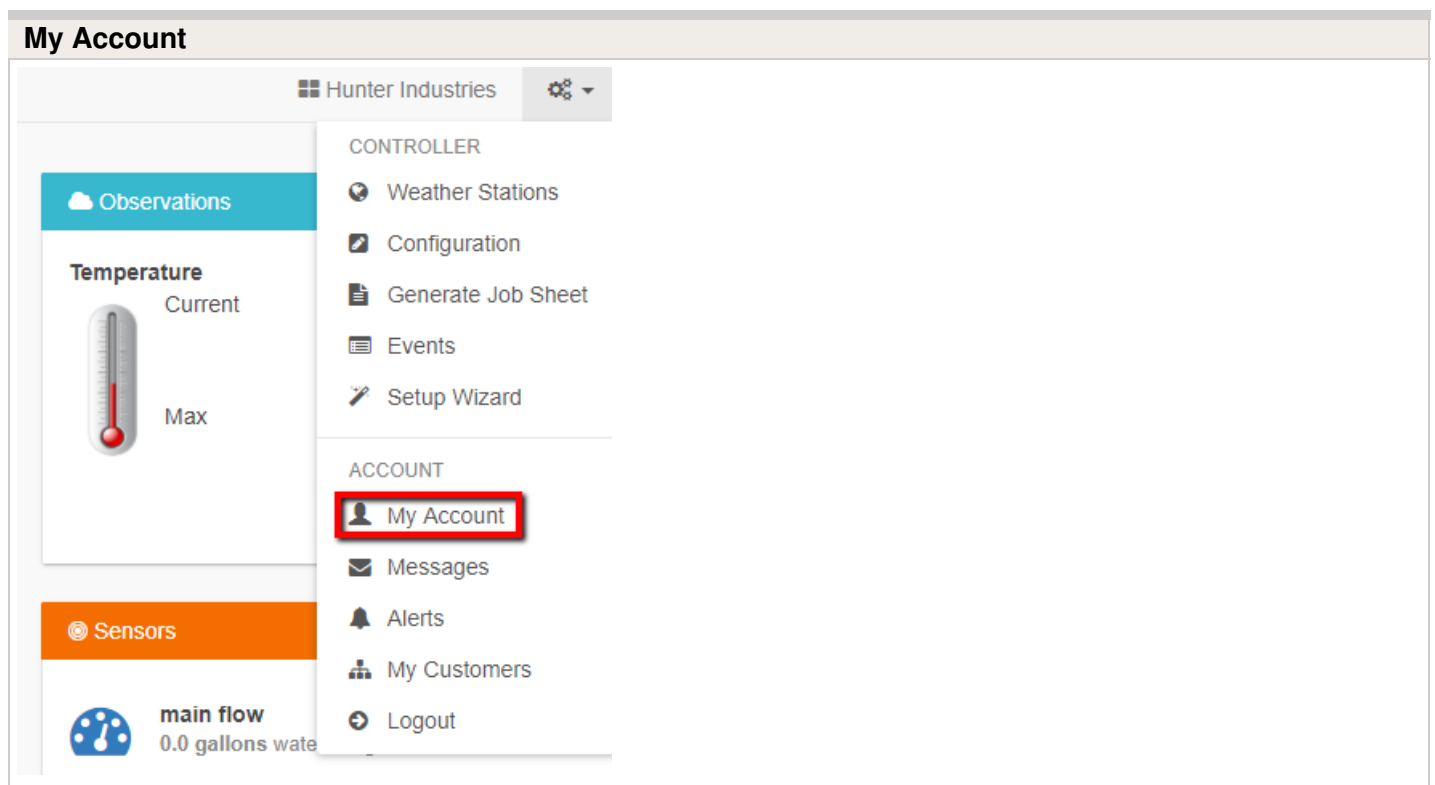

**My Account**

Hunter Industries

CONTROLLER

- Weather Stations
- Configuration
- Generate Job Sheet
- Events
- Setup Wizard

ACCOUNT

- My Account**
- Messages
- Alerts
- My Customers
- Logout

Observations

Temperature

Current

Max

Sensors

main flow

0.0 gallons water

You can view/edit the following in the account details section:

1. **User Settings**
2. **Account Settings**
3. **Plan Details**
4. **Privacy settings**

## My Account

### My Account Details

Check and edit user account information, including password, plans and contractors

#### USER SETTINGS

UNITS OF MEASUREMENT  
Fahrenheit & Inches

LANGUAGE  
English

  
**Brendan**  
brendan.proffitt@hunterindustries.com

#### ACCOUNT SETTINGS

API KEY  
D51A-6EB2-531F-3AEE [Generate API Key](#)

NOTIFICATION EMAIL  
contractor@hydrawise.com

#### PLAN DETAILS

PLAN TYPE  
Contractor (expires on Tue 19 May 2020)

IMAGE STORAGE  
6.7MB of 10.0MB

FILE STORAGE  
0.3MB of 100.0MB

SMS ALERTS  
Sent 0 SMS in last 30 days

CONTROLLERS  
11 controller configured out of a maximum of 50 controllers

#### PRIVACY SETTINGS

You are on a contractor plan and this is how your contact details appear to your customers

**Hydrawise Contractor**  
Hydrawise Smart Controller and Water Management Software - Get more control from your sprinkler system.



CONTACT DETAILS  
contractor@hydrawise.com

ADDRESS  
San Marcos

WEBSITE  
<http://hydrawise.com>

## User Settings

From this screen, you can change the following:

1. Name of user
2. Email address
3. Picture of user
4. Change the units of measurement
5. Edit password.

**Edit User**

Edit User
✕



Change picture

**Name**

**Email Address**

**Units of Measurement**

Fahrenheit & Inches
▼

Change Password

Cancel

OK

## Account Settings

From this screen, you can change the following:

1. Choose the user that notifications for account issues should be sent out.

### Edit Notification Email

Edit Notification Email ✕

**Accounts**

Choose the user that notifications for account issues should be sent to

contractor@hydrawise.com

Cancel OK

## Plan Details

From this screen, you can view the plan type, image storage, file storage, SMS alerts, and controller amount. You can **edit** the following: change or upgrade plan.

### Choose Plan

Choose Your Subscription Plan

Home Owner Plans
  Contractor Professional Plans

The Hydrawise system is free for most users worldwide. For those interested in even more w the Enthusiast Plan provides access to more than 100,000 personal, airport and official weatl

<div style="background-color: #a6a6a6; color: white; padding: 5px; text-align: center; margin-bottom: 5px;">Home</div> <div style="text-align: center; margin-bottom: 5px;"> <span style="background-color: #494949; color: white; border-radius: 50%; padding: 10px 20px; display: inline-block;">Free</span> </div> <ul style="list-style-type: none"> <li>✓ Select from over 10,000 Airport Weather Stations</li> <li>✓ Monitor 1 Weather Station Simultaneously</li> <li>✓ Daily Schedule Updates</li> </ul>	<div style="background-color: #2952a3; color: white; padding: 5px; text-align: center; margin-bottom: 5px;">Enthusiast</div> <ul style="list-style-type: none"> <li>✓ Select from c and Personal</li> <li>✓ Monitor up to Simultaneous</li> <li>✓ Hourly Schec</li> </ul>
--	---

## Privacy settings

From this screen, you can view the contact details, address, and website. You can **edit** the following:

1. Search and select a contractor you want to manage your controller.
2. Make your account private if previously managed by a contractor.

### Contractor Selection

## Contractor Selection

Filter by radius  30kms  80kms  160kms

## Making Account Private

### Contractor Selection

Filter by radius  30kms  80kms  160kms

Here are the closest 6 Hydrowise contractors to you based on your s

**Proffitt Construction** (Your Contractor) CONTRACTOR STARTER

**CONTACT**  
760-304-7218

**LOCATION**  
1943 Diamond Street, San Marcos, CA, United States

[MAKE ACCOUNT PRIVATE](#)

## Contractor Selection

Filter by radius  30kms  80kms  160kms



# Account - Changing Current Controller

From the menu, choose the **Controller name** in the top right.

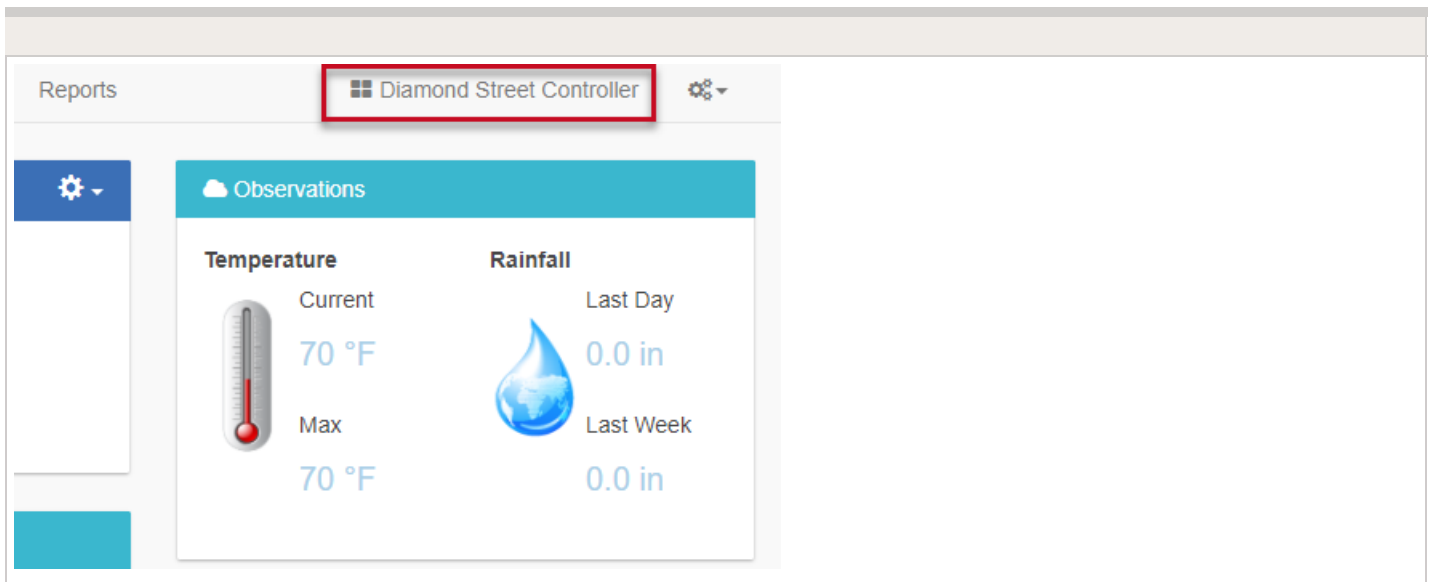

This will give you a list of all the controllers in your account. Click on the controller name to change to configuring that controller.

Choose the **controller** you want to view.

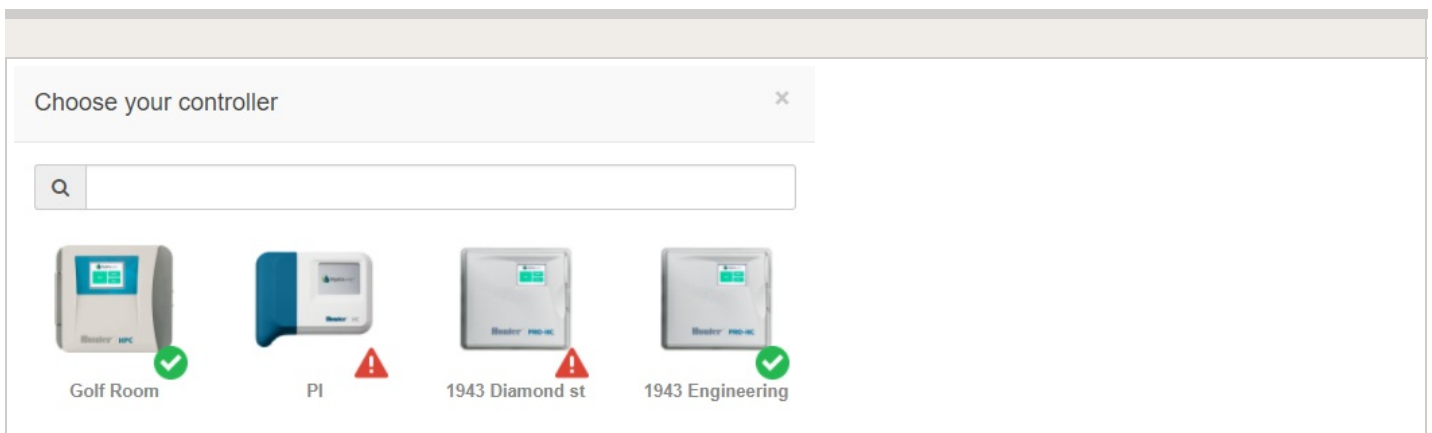

---

# Account - Assigning/Removing Images on PC

Please view the steps and screenshots to access this feature:

## Assigning New Image

Click on "**Zones and Schedules**" from the home dashboard. Scroll down to the first zone you choose to edit.

1. Click on the "**picture plus icon.**"
2. Choose "**file name**" to upload as your zone image.
3. Image will now be added to your zone.

For information on image storage for your account, please us this [article](#) <sup>[26]</sup>.

### STEP 1

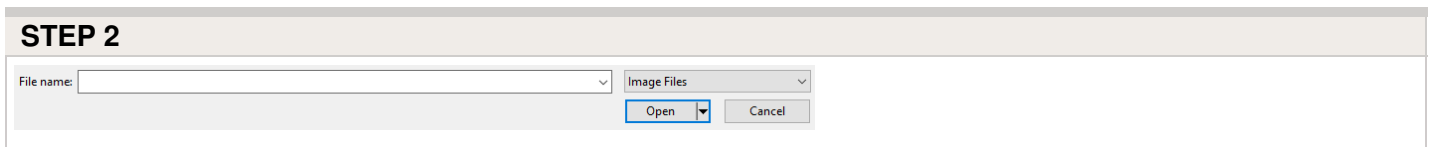
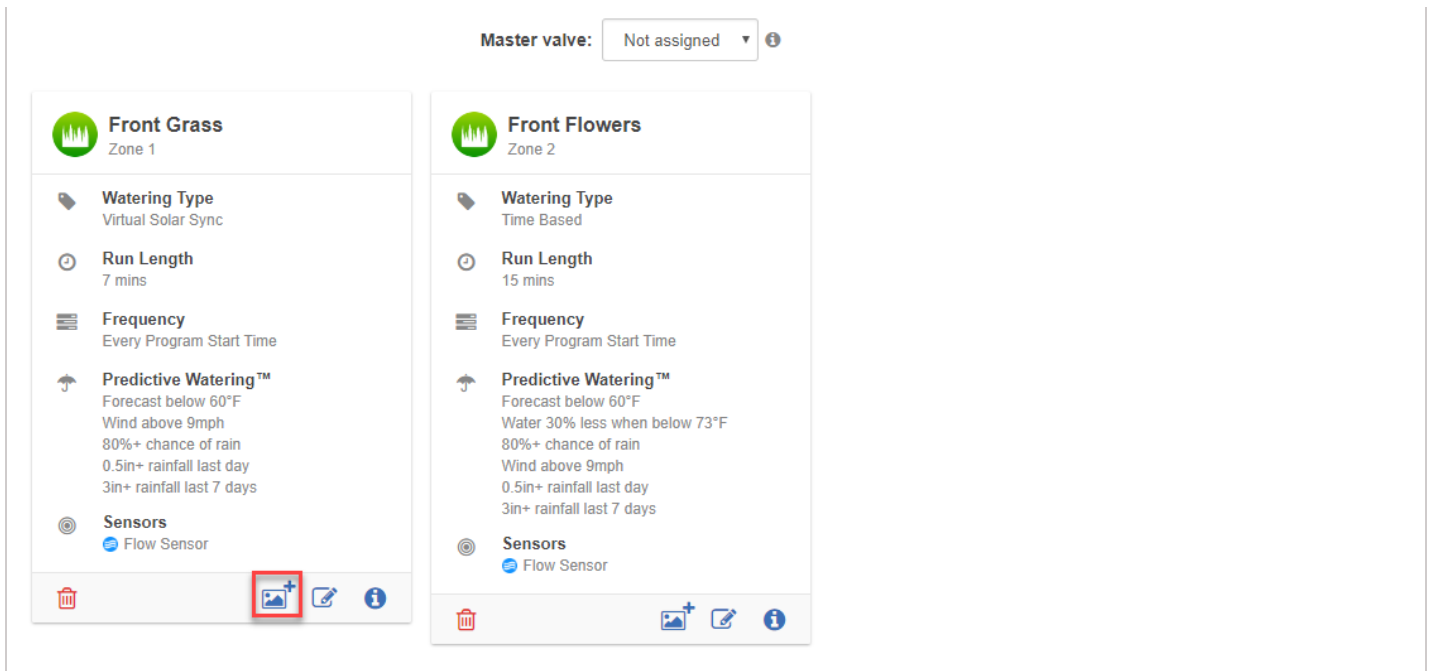

## Removing Image

Click on "**Zones and Schedules**" from the home dashboard. Scroll down to the first zone you choose to edit.

1. Click on the "**assigned image.**"
2. Choose "**delete icon**" on the upper right hand side of the screen.
3. Image will now be removed from your zone.

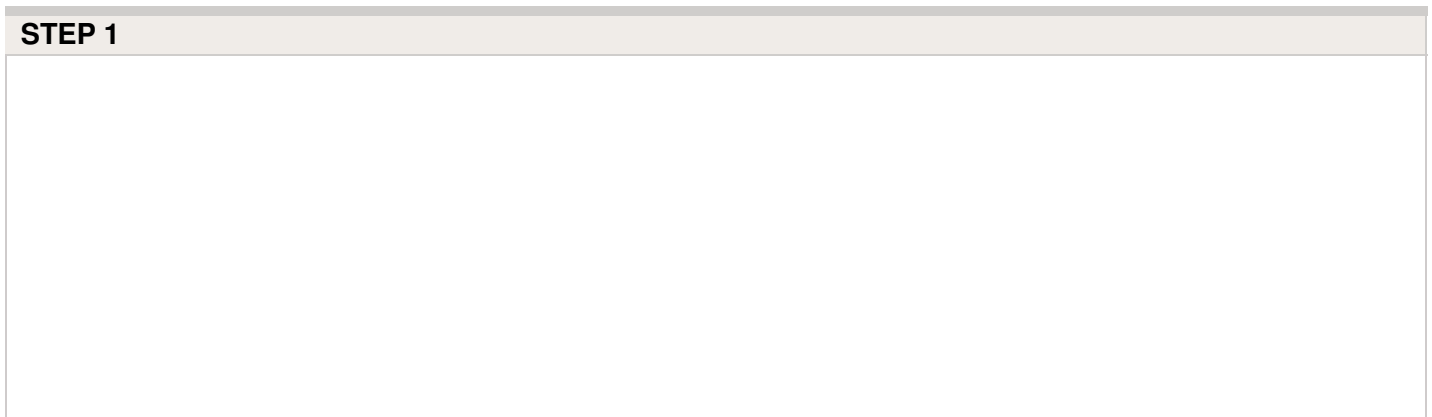

Master valve: Not assigned

**Front Grass**  
Zone 1



- Watering Type**  
Time Based
- Run Length**  
25 mins
- Frequency**  
Every 2 days
- Predictive Watering™**  
None



**Street Drip**  
Zone 2



- Watering Type**  
Time Based
- Run Length**  
30 mins
- Frequency**  
Every 2 days
- Predictive Watering™**  
None



## STEP 2

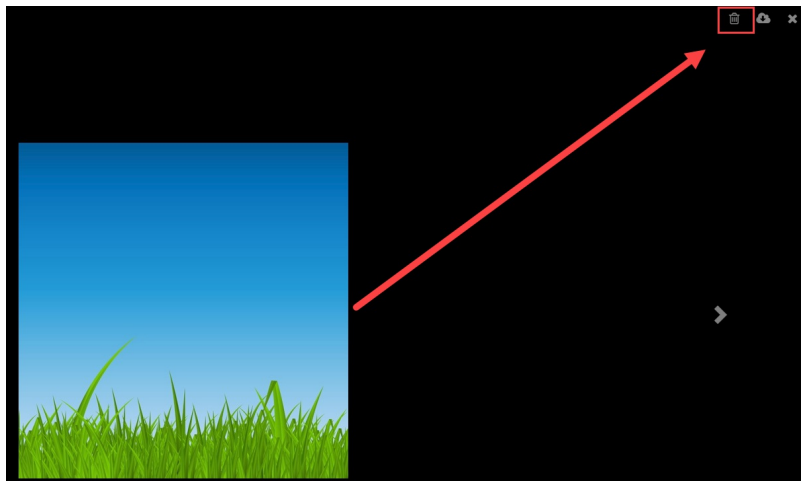

# Account - Assigning Images on

# Mobile

Before assigning the image to an individual zone with your mobile device, please make sure it is captured in the correct orientation (landscape) mode as seen in the illustration below:



From the "zones section", you can assign an image to each zone. Click on the Image Add button  next to the Zone Edit button at the bottom right.

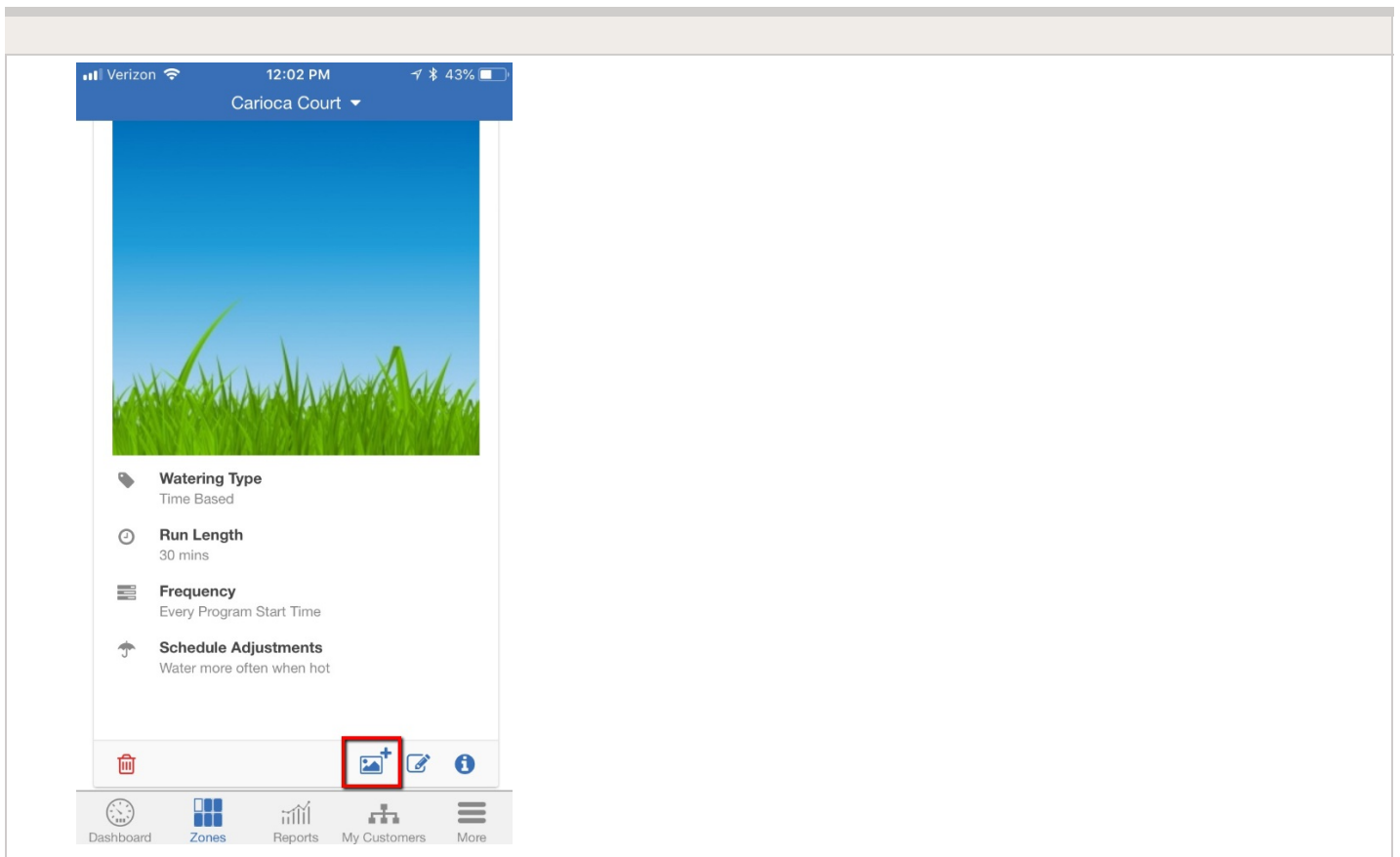

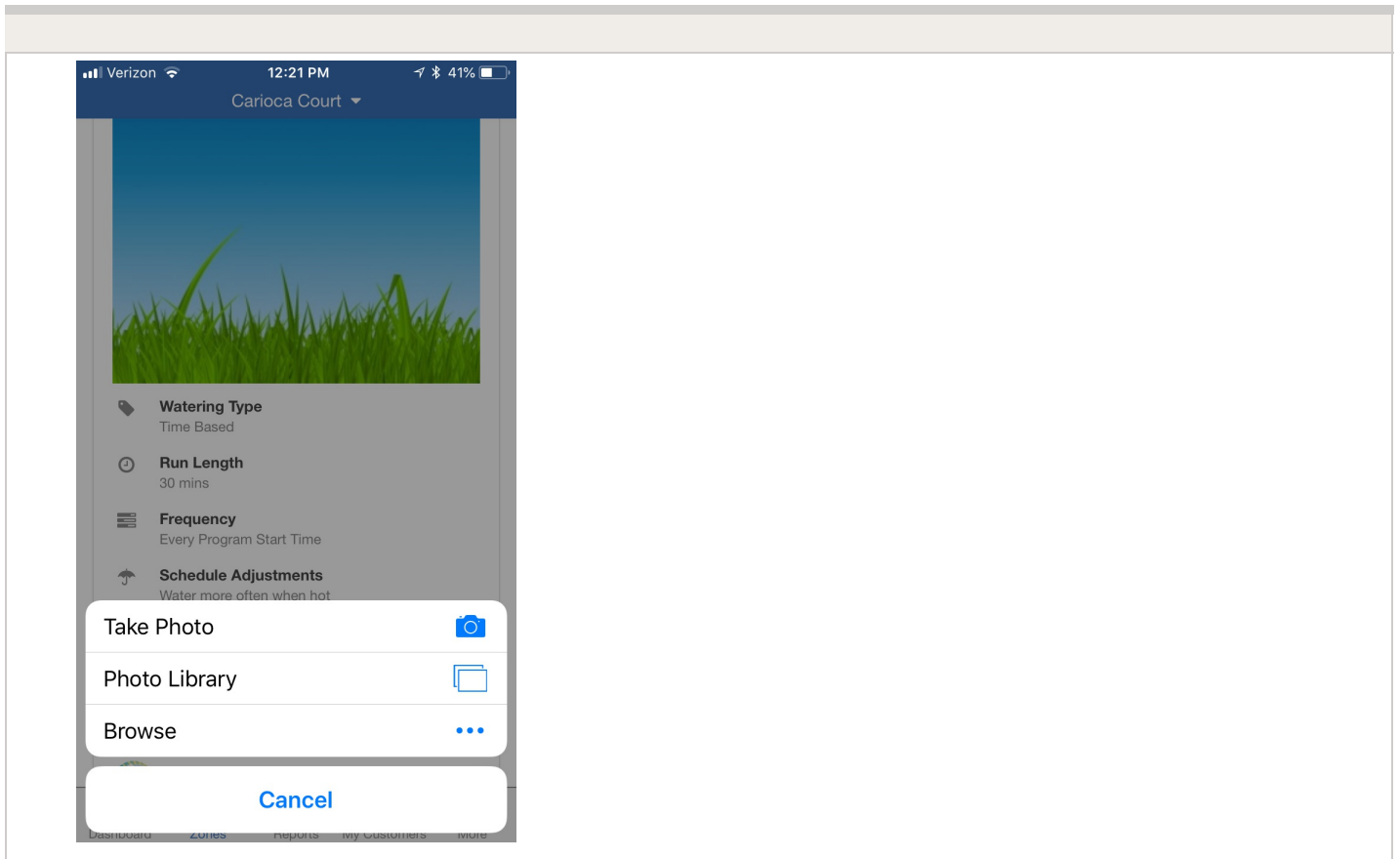

You can **upload** multiple images per zone or take a photo using phone camera. The total number of images that can be uploaded is based on the images size and is different for each account's Plan Subscription.

After an image is uploaded you can select an image to be displayed on the Dashboard by editing the zone [✎](#) and selecting the image in the Zone Icon list.

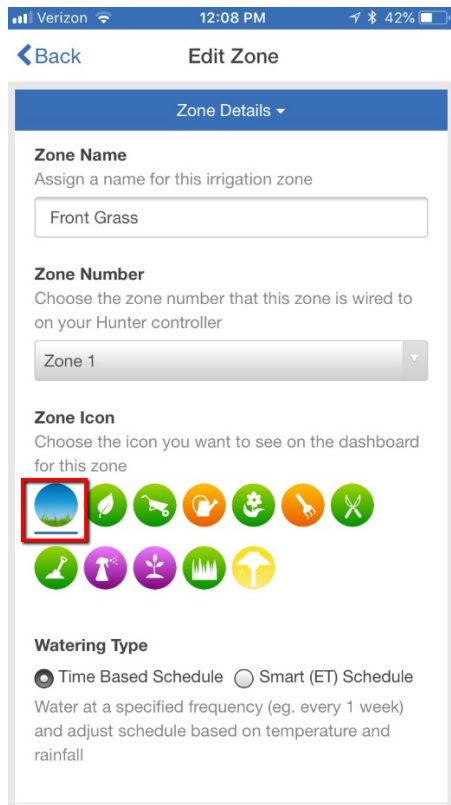

To **REMOVE** the image, you can click on the image in the "zones" settings and the following screen will appear. The existing image can be deleted and new one added on the upper right-hand side.

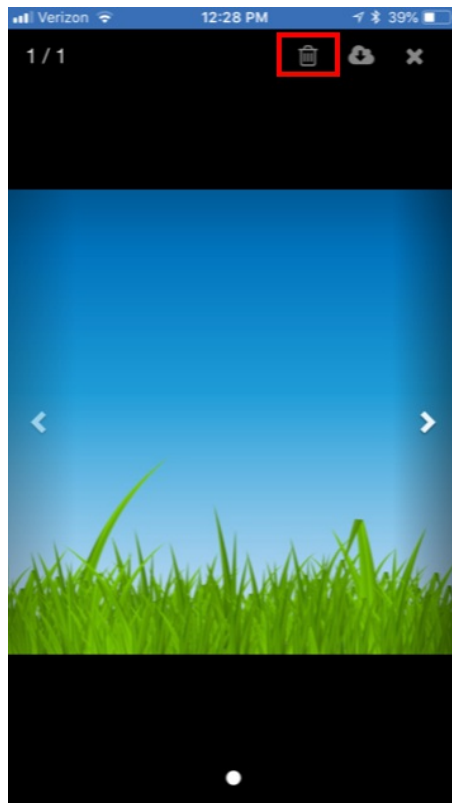

---

## Account - Delete Controller

If you have the need to delete a controller from your account, please use the steps and screenshots listed below:

1. Make sure you are **NOT** currently configuring the controller you would like to delete. Click on the **"current controller name."**
2. Change controller by selecting another one from the **"Choose your controller"** category.
3. Click on the top right three gears to access your **"My Account"** settings.
4. Scroll down to the bottom controller section. Click on the **"three selection dots"** to the right of the controller name.



5. Choose **"Remove Serial Number"** to remove controller from the account.
6. Choose **"Delete"** to remove controller from the account.

The controller will now be removed from you account.

### STEP 1

Sensors Reports Carioca Court

Observations

Temperature

Current 63 °F

Max 63 °F

Rainfall

Last Day 0.0 in

Last Week 0.0 in

Grass

### STEP 2

Choose your controller

Carioca Court

PROHC Office

1525 Hidden Oaks Lane SE

Garrison Road

### STEP 3

PROHC Office

Observations

Temperature

Current

Max

Sensors

No sensors configured. A

CONTROLLER

- Weather Stations
- Configuration
- Generate Job Sheet
- Events
- Setup Wizard

ACCOUNT

- My Account**
- Messages
- Alerts
- My Customers
- Logout

#### STEP 4

My Controllers

Search

CONTROLLERS

- Carioca Court
- PROHC Office

Configure

Delete

Remove Serial Number

Generate Job Sheet

Move Controller

#### STEP 5

**My Controllers**

Q Search

---

CONTROLLERS +

- Carioca Court ⋮
- PROHC Office ⋮

- Configure
- Delete
- Remove Serial Number**
- Generate Job Sheet
- Move Controller

**STEP 6**

**My Controllers**

Q Search

---

CONTROLLERS +

- Carioca Court ⋮
- PROHC Office ⋮

- Configure
- Delete**
- Remove Serial Number
- Generate Job Sheet
- Move Controller

**NOTE:** If you attempt to delete a controller that you are currently configuring, the message will appear below.





You cannot delete a controller you are currently configuring

OK

---

# Account - Watering Type - Time Based

Time based watering will water on specific days (unless delayed by rainfall or forecast rainfall) and will vary the watering length based on your watering triggers. The controller will use the Watering Triggers you've set to automatically adjust its watering schedule. This Watering type would be most common as it allows the user to set the information manually or choose from a list of pre-configured watering schedules.

Please view the steps and screenshots to access this feature:

Click on "**Zones and Schedules**" from the home dashboard. Scroll down to the first zone you choose to edit. Click on the  icon.

1. Choose "**Time Based**" as the watering type and click "**next.**"
2. Choose the following options for the Time Based Schedule.
  - Watering type - time and frequency or preconfigured schedule <sup>[27]</sup>.
  - Watering length - run time for zone in minutes.
  - Watering frequency - Every start time or interval days
  - Predictive watering adjustments - Adjusted based on your water triggers
  - Monthly adjustments can be made using a chart as well.
  - Click "**next**" when adjustments are complete.
3. Choose "**enable or disable**" the cycle soak feature <sup>[28]</sup>.
4. Finally, the Advance Section will allow you to select a "**watering Adjustment**" as a %.

### STEP 1

**Zone Details** ▶ **Time Based Schedule** ▶ **Cycle & Soak** ▶ **Advanced**

**Zone Name**  
Assign a name for this irrigation zone

**Zone Number**  
Choose the zone number that this zone is wired to on your Hunter controller

**Zone Icon**  
Choose the icon you want to see on the dashboard for this zone  

**Watering Type**  
 Time Based Schedule  Smart (ET) Schedule  Virtual Solar Sync™  
Water at a specified frequency (eg. every 1 week) and adjust schedule based on temperature and rainfall

### STEP 2

**Zone Details** ▶ **Time Based Schedule** ▶ **Cycle & Soak** ▶ **Advanced**

**Watering Type**

- Enter Time and Frequency below
- Use a Preconfigured Watering Schedule

**Watering Length**

The number of minutes this zone will run for each time

10 minutes

**Watering Frequency**

Choose how often this zone should run

- Every Program Start Time
- Interval Based Watering

**Predictive Watering™**

Adjust watering based on the following triggers

Don't water when:

- Forecast below 60°F
- Wind above 9mph
- 3in+ rainfall last 7 days
- 80%+ chance of rain
- 0.5in+ rainfall last day

Adjust watering:

- Water 30% less when below 73°F
- Water longer when hot
- Water more often when hot

In addition to daily predictive watering adjustments you can specify **monthly adjustments** using the chart below

5 May 0% 80% 200%

Cancel < Prev **Next >** ✓ OK

### STEP 3

**Zone Details** ▶ **Virtual Solar Sync** ▶ **Cycle & Soak** ▶ **Advanced**

**Cycle & Soak**

Cycle and soak reduces runoff from each zone by pausing an irrigation cycle ⓘ

- Do not enable cycle and soak
- Enable cycle and soak

Cancel < Prev **Next >** ✓ OK

### STEP 4

**Zone Details** ▶ **Virtual Solar Sync** ▶ **Cycle & Soak** ▶ **Advanced**

**Water Adjustment**

Fine tune your watering if your zone appears to be too dry or wet

Water less **Normal** Water more

Water for normal watering length

Cancel < Prev **Next >** ✓ OK

# Account - Watering Type - Smart

# (ET) Watering

**Smart (ET) watering** is an automated watering schedule that uses information about environmental conditions to ensure your plants get the optimal amount of water. Evaporation will draw moisture from your garden, while rainfall and irrigation will add moisture. Understanding these conditions allows Hydrowise to decide when the time is right to water your garden. ET stands for evapotranspiration and is explained further in the diagram below.

For each zone, you will have to assign the watering length and peak watering frequency:

- The watering length is how long watering needs to run to fully water your zone.
- The peak watering frequency is how often you would normally water this zone during your peak irrigation period.

The controller will vary your watering frequency based on actual evaporation and rainfall in your area on a day to day basis. In contrast to Time Based Watering and Virtual Solar Sync, Smart Watering will always water a zone for the same length of time and it will vary the frequency of watering based on temperature and rainfall.

Please view the steps and screenshots to access this feature:

Click on "**Zones and Schedules**" from the home dashboard. Scroll down to the first zone you choose to edit. Click on the  icon.

1. Choose "**Smart (ET) watering**" as the watering type and click "**next.**"
2. Choose the following options for the Smart (ET) schedule.
  - Watering type - Time and frequency or preconfigured schedule <sup>[27]</sup>.
  - Watering length - Run time for zone in minutes.
  - Peak Season Watering frequency - Days between watering in peak of season.
  - Predictive watering adjustments - Uses ET data from weather stations
  - Monthly adjustments can be made using a chart as well here.
  - Click "**next**" when adjustments are complete.
3. Choose "**enable or disable**" the cycle soak feature <sup>[28]</sup>.
4. Finally, the Advance Section will allow you to select a "**watering Adjustment**" as a %.

**Note:** For more information on how smart watering works, please view the article here. <sup>[29]</sup>

## STEP 1

**Zone Name**

Assign a name for this irrigation zone

**Zone Number**

Choose the zone number that this zone is wired to on your Hunter controller

**Zone Icon**

Choose the icon you want to see on the dashboard for this zone



**Watering Type**

Time Based Schedule  Smart (ET) Schedule  Virtual Solar Sync™

Adjust your watering frequency based on evaporation and rainfall

Cancel

## STEP 2

Your schedule will be adjusted based on evaporation and rainfall.

**Watering Type**

Enter Time and Frequency below  
 Use a Preconfigured Watering Schedule

**Watering Length**

The number of minutes this zone will run for each time  
 minutes

**Peak Season Watering Frequency**

Enter the time between watering in the peak of your irrigation season

days

Run this zone at the next available start time

**Predictive Watering™**

Your schedule is adjusted each day using ET from your weather stations. In addition to ET adjustments you can use the following Watering Triggers:

Don't water when:  
 Forecast below 60°F  Predict watering using:  
 Forecast ET  Forecast rainfall

In addition to daily ET adjustments you can specify monthly adjustments using the chart below

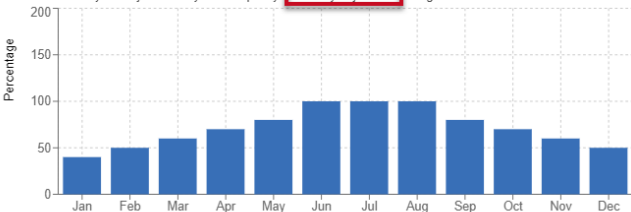

Cancel

## STEP 3



Zone Details > Virtual Solar Sync > Cycle & Soak > Advanced

**Cycle & Soak**  
 Cycle and soak reduces runoff from each zone by pausing an irrigation cycle ⓘ

Do not enable cycle and soak  
 Enable cycle and soak

Cancel < Prev **Next >** ✓ OK

**STEP 4**

Zone Details > Virtual Solar Sync > Cycle & Soak > Advanced

**Water Adjustment**  
 Fine tune your watering if your zone appears to be too dry or wet

Water less Normal Water more

Water for normal watering length

Cancel < Prev **Next >** ✓ OK

# Account - Watering Type - Virtual Solar Sync

This operates the same way as the Hunter Solar Sync by adjusting the run time per zone. It uses daily ET from your selected weather stations instead of on-site ET so it does not require on-site Solar Sync sensor installation. If no weather station ET is available, then it will fall back to using forecast ET and historical ET. The virtual Solar Sync makes its adjustments based on the rolling average of the last three days of data.

Hunter's Solar Sync Region and Water Adjustment settings	
Region	Determined automatically based on your controller's location from the weather station selected.
Water Adjustment	Use the Advanced Tab when editing a zone to adjust the zone's watering. See step 4 below:
Run Times	Set station run times for peak summer watering. For assistance on establishing correct run times for your

Please view the steps and screenshots to access this feature:

Click on "**Zones and Schedules**" from the home dashboard. Scroll down to the first zone you choose to edit. Click on the  icon.

1. Choose "**Virtual Solar Sync**" as the watering type and click "**next.**"
2. Choose the watering length, watering frequency, and weather adjustments and click "**next.**"
3. Choose "**enable or disable**" the cycle soak feature.
4. Finally, the Advance Section will allow you to select a "**watering Adjustment**" as a %.

### STEP 1

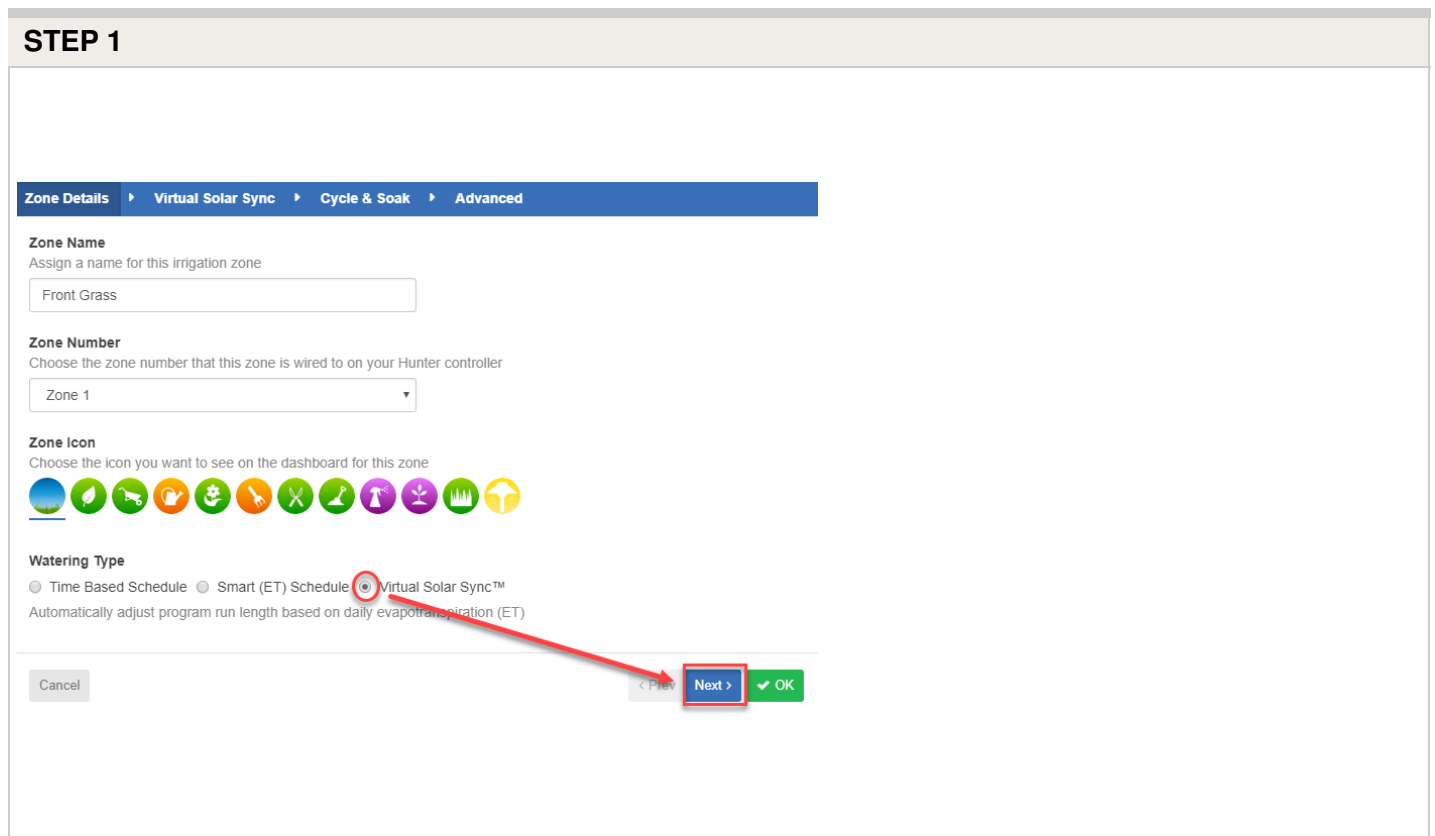

**Zone Details** > **Virtual Solar Sync** > **Cycle & Soak** > **Advanced**

**Zone Name**  
Assign a name for this irrigation zone  
Front Grass

**Zone Number**  
Choose the zone number that this zone is wired to on your Hunter controller  
Zone 1

**Zone Icon**  
Choose the icon you want to see on the dashboard for this zone

**Watering Type**  
 Time Based Schedule  Smart (ET) Schedule  Virtual Solar Sync™  
Automatically adjust program run length based on daily evapotranspiration (ET)

Cancel < Prev **Next >** OK

### STEP 2

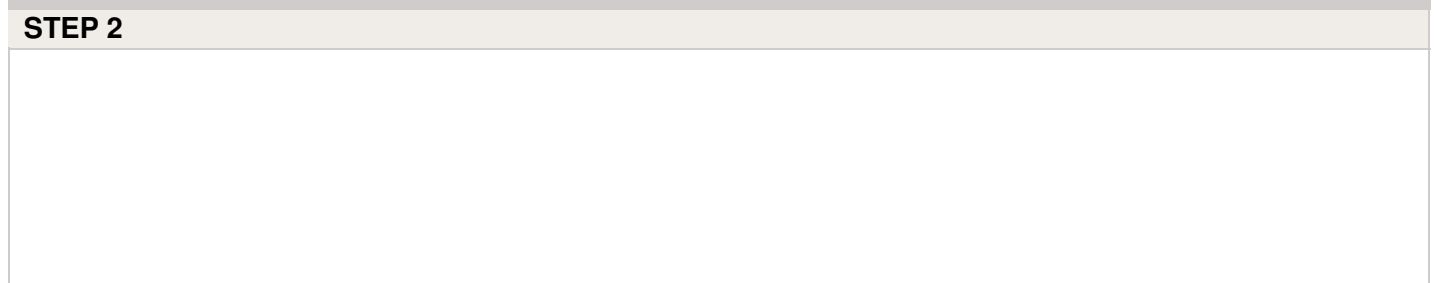

Zone Details > Virtual Solar Sync > Cycle & Soak > Advanced

**Watering Type**

- Enter Time and Frequency below
- Use a Preconfigured Watering Schedule

**Watering Length**

The number of minutes this zone will run for each time

30 minutes

**Watering Frequency**

Choose how often this zone should run

- Every Program Start Time
- Interval Based Watering

**Predictive Watering™**

Adjust watering based on the following triggers

- Don't water when:
  - Forecast below 60°F
  - 80%+ chance of rain
  - 3in+ rainfall last 7 days
- Wind above 9mph
- 0.1in+ rainfall last day

Cancel < Prev **Next >** ✓ OK

### STEP 3

Zone Details > Virtual Solar Sync > Cycle & Soak > Advanced

**Cycle & Soak**

Cycle and soak reduces runoff from each zone by pausing an irrigation cycle

- Do not enable cycle and soak
- Enable cycle and soak

Cancel < Prev **Next >** ✓ OK

### STEP 4

Zone Details > Virtual Solar Sync > Cycle & Soak > Advanced

**Water Adjustment**

Fine tune your watering if your zone appears to be too dry or wet

Water less **Normal** Water more

Water for normal watering length

Cancel < Prev **Next >** ✓ OK

After Virtual Solar Sync has been installed and programmed, it is recommended to allow the system to run for a few days at the initial setting. Because of the variety in site conditions, the initial setting may require adjustment in order to achieve the desired performance.

### Virtual Solar Sync and Pre-configured Watering Schedule Note:

In order to have this in the option when in Virtual Solar Sync, you must first have a pre-configured schedule assigned in the account. The drop down here will not display any

schedule without completing the necessary steps found in the article [here](#) <sup>[31]</sup> or simply click **CREATE NEW** as shown in the section below.

### Pre-configured Watering Schedule Drop Down

Zone Details ▶ Virtual Solar Sync ▶ Cycle & Soak ▶ Advanced

**Watering Type**

Enter Time and Frequency below

Use a Preconfigured Watering Schedule

**Watering Schedule**

Choose the Watering Schedule that this zone will use, or create a new one

Click the button below to create a new one ▼

Create New...

---

Cancel < Prev Next > ✓ OK

## Account - Virtual Weather Station

The Virtual Weather Station is a weather station that is created based on the geographic location of the controller. The station is not real, but uses complex algorithms, satellite data, real weather stations, atmospheric data from airplanes, and pressure readings from mobile phones to calculate a comprehensive, highly accurate history for the selected location. The Virtual Weather Station can now be selected as a weather station and is free to use.

Please view the steps and screenshots to access this feature:

1. Click on the settings icon on the upper right, then select **"Weather stations."**
2. Your free **"virtual weather station"** should already be shown at your address.
3. Click on the purple icon for your virtual weather station and click **"select."**

**NOTE:** The virtual weather station will appear more visible on the map if the boxes in STEP-2 are unchecked for the personal and airport weather stations.

## STEP 1

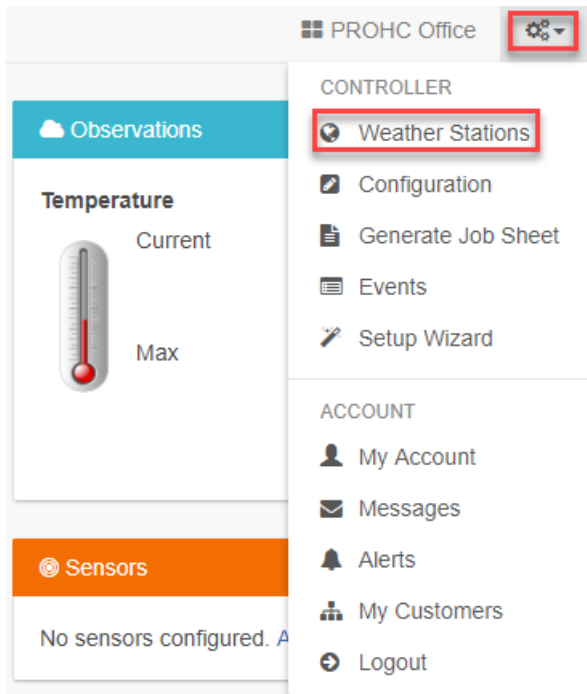

PROHC Office

CONTROLLER

- Weather Stations**
- Configuration
- Generate Job Sheet
- Events
- Setup Wizard

ACCOUNT

- My Account
- Messages
- Alerts
- My Customers
- Logout

Observations

Temperature

Current

Max

Sensors

No sensors configured. A

## STEP 2

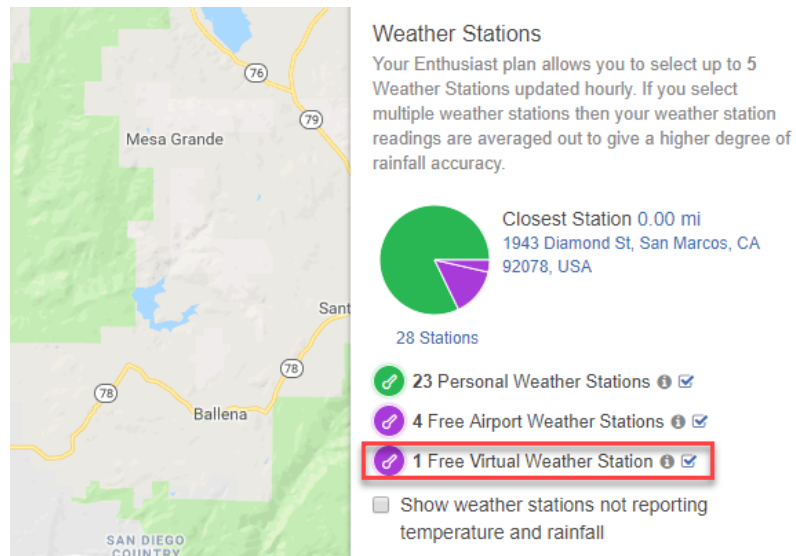

**Weather Stations**

Your Enthusiast plan allows you to select up to 5 Weather Stations updated hourly. If you select multiple weather stations then your weather station readings are averaged out to give a higher degree of rainfall accuracy.

Closest Station 0.00 mi  
1943 Diamond St, San Marcos, CA  
92078, USA

28 Stations

- 23 Personal Weather Stations
- 4 Free Airport Weather Stations
- 1 Free Virtual Weather Station**

Show weather stations not reporting temperature and rainfall

## STEP 3

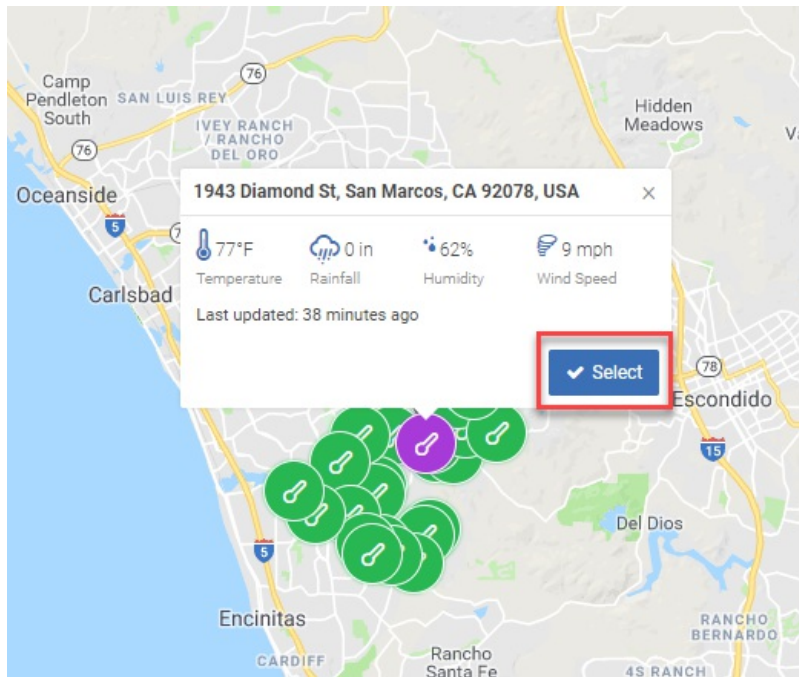

# Alerts - Auto suspend for high flow

This action for the alert "**High water usage for a zone**" allows the user to automatically suspend the zone a number of days/weeks when high flow is detected. This will allow the time in the field to make all repairs necessary. To learn more about alerts, click [here](#) <sup>[32]</sup>.

Please view the steps to access this action:

Click on **Settings**  icon and scroll down to select "**Alerts.**"

1. Click on "**Add New Alert.**"
2. Choose "**Alert Name, Type and percentage**" then click "**next.**"
3. Choose from drop down to apply to all "**controllers/sensors**" or only "**selected ones.**"
4. Under actions, select "**suspend the zone,**" and number of "**days**" to be suspended, then click "**ok.**"

**NOTE:** Max suspension is unlimited for days and weeks.

## STEP 1

**Alerts**

Alerts allow you to be notified of potential issues with your controller wiring, valves, pipes or Hunter controller

  
Add new alert

## STEP 2

Edit Alert ×

**Alert Name** ▶ **Applies To** ▶ **Actions**

**Alert Name**

**Alert Type**

Zone's water usage rate is higher than the previous time this zone ran  %

**STEP 3**

Edit Alert ×

**Alert Name** ▶ **Applies To** ▶ **Actions**

**Applies To**

Applies to all controllers, sensors ▼

Cancel < Prev **Next >** ✓ OK

**STEP 4**

Edit Alert ×

**Alert Name** ▶ **Applies To** ▶ **Actions**

Add event to the event log  
Add this alert to the controller's event log

Send App notification

Send SMS/Text notification

Suspend the zone

5| ▾ Days ▾

Cancel < Prev **Next >** ✓ OK

# Account - Units of Measurement

For information on changing the units of measurement for your area, please see the steps below:

1. Select the three gears on the upper right on the dashboard.
2. Click "My Account"
3. Click the  icon in the user settings box.
4. Scroll down to choose the correct units of measurement. Screenshots below:



## STEP 1

The screenshot shows the 'Football field' settings page. At the top, there is a header with 'Football field' and a gear icon. Below this, there are two main sections: 'Observations' and 'Sensors'. The 'Observations' section shows a temperature gauge with 'Current' and 'Max' labels, and a large '63 °F' reading. The 'Sensors' section shows a green square icon for 'Sensor a' with the text 'This sensor is no...'. A dropdown menu is open, listing various options under 'CONTROLLER' and 'ACCOUNT'. The 'My Account' option under 'ACCOUNT' is highlighted with a red box.

Football field

**CONTROLLER**

- Weather Stations
- Configuration
- Generate Job Sheet
- Events
- Setup Wizard

**ACCOUNT**

- My Account**
- Messages
- Alerts
- My Customers
- Logout

**Observations**

**Temperature**

Current

Max

63 °F

**Sensors**

**Sensor a**  
This sensor is no...

## STEP 2

The screenshot shows the 'USER SETTINGS' page. On the left, there are two settings: 'UNITS OF MEASUREMENT' set to 'Celsius & Millimeters' and 'LANGUAGE' set to 'English'. On the right, there is a user profile card with a circular profile picture icon, the name 'Hydrawise Contractor', and the email address 'contractor@hydrawise.com'. A red box highlights a small edit icon (a pencil inside a square) located at the bottom right of the user profile card.

**USER SETTINGS**

UNITS OF MEASUREMENT  
Celsius & Millimeters

LANGUAGE  
English

Hydrawise Contractor  
contractor@hydrawise.com

## STEP 3

This screenshot is empty, representing Step 3 of the process.

Edit User ✕



Change picture

**Name**

**Email Address**

**Units of Measurement**

**Language**

# Account - Adding a Contractor

If you have a contractor in your area where you would like them to manage or view your controller settings when necessary, please follow the steps below:

1. Navigate to the three gear icon on the upper right, then Click on **My Account**.
2. Click on  **icon** and you can select.
3. You will now have the option to **search** and **select** a contractor in your area filtered by the radius selected.

**STEP 1**

Hunter Industries 

**Observations**

**Temperature**

Current



Max

**Sensors**

**main flow**  
0.0 gallons water

**CONTROLLER**

- Weather Stations
- Configuration
- Generate Job Sheet
- Events
- Setup Wizard

---

**ACCOUNT**

- My Account**
- Messages
- Alerts
- My Customers
- Logout

### STEP 2

PRIVACY SETTINGS

You do not have a contractor plan



### STEP 3

#### Contractor Selection

Filter by radius  30kms  80kms  160kms

Here are the closest 6 Hydrowise contractors to you based on your ad

BRONZE

**Proffitt Landscapes** (Your Contractor)



 CONTACT

 LOCATION  
1943 Diamond Street, San Marcos, CA, United States

MAKE ACCOUNT PRIVATE

---

# Account - Cycle/Soak Operation

The **Cycle and Soak** feature allows the user to split each station's run time into more usable, shorter duration watering. This feature is particularly applicable for slopes and tight soil (such as clay) because Cycle and Soak will help prevent excessive run off. You should enter the Cycle time as a fraction of the station's watering time and the Soak time as the minimum soak required before watering the next portion. The total number of cycles is determined by taking the total programmed station run time and dividing it by the Cycle time.

- **Cycle Time** is the maximum number of minutes for which the zone can run at a time.
- **Soak Time** is the minimum time between zone watering to allow water to soak into the soil.

**For example:** Suppose Station 1 required 20 minutes worth of water but after only 5 minutes, runoff occurred. However, after 10 minutes all the water was absorbed. The solution would be to program 20 minutes for the Station Run Time, 5 minutes for the Cycle time, and 10 minutes for the Soak. Station 1 will then water for 5 minutes and then the rest of the stations in the program will water. After all the other stations have watered the controller will check to see if Station 1 had soaked for at least 10 minutes. If it had, then Station 1 will water for another 5 minutes. This process would continue to repeat itself until Station 1 watered 4 times for 5 minutes each time, a total of 20 minutes.

**Note:** To test Cycle and Soak, you will need to have a scheduled run for automatic because running a zone manually from the app does not allow Cycle and Soak to take effect.

**Important Offline:** If your controller goes offline, your default watering schedule will still run, but Cycle and Soak will not work. Each zone will water its full length while offline.

# Account - Account Name Edit

To rename the account, please view the steps and screenshots to access this feature:

1. Click on **Settings > My Account**, located on the top right of the **Dashboard** as shown below.
2. Once you are in **My Account**, click on the  icon near the **User Settings** field.
3. Enter the new **NAME** desired shown in the box.

**NOTE:** The default account name is your login name until you change it to be something else.

**STEP 1**

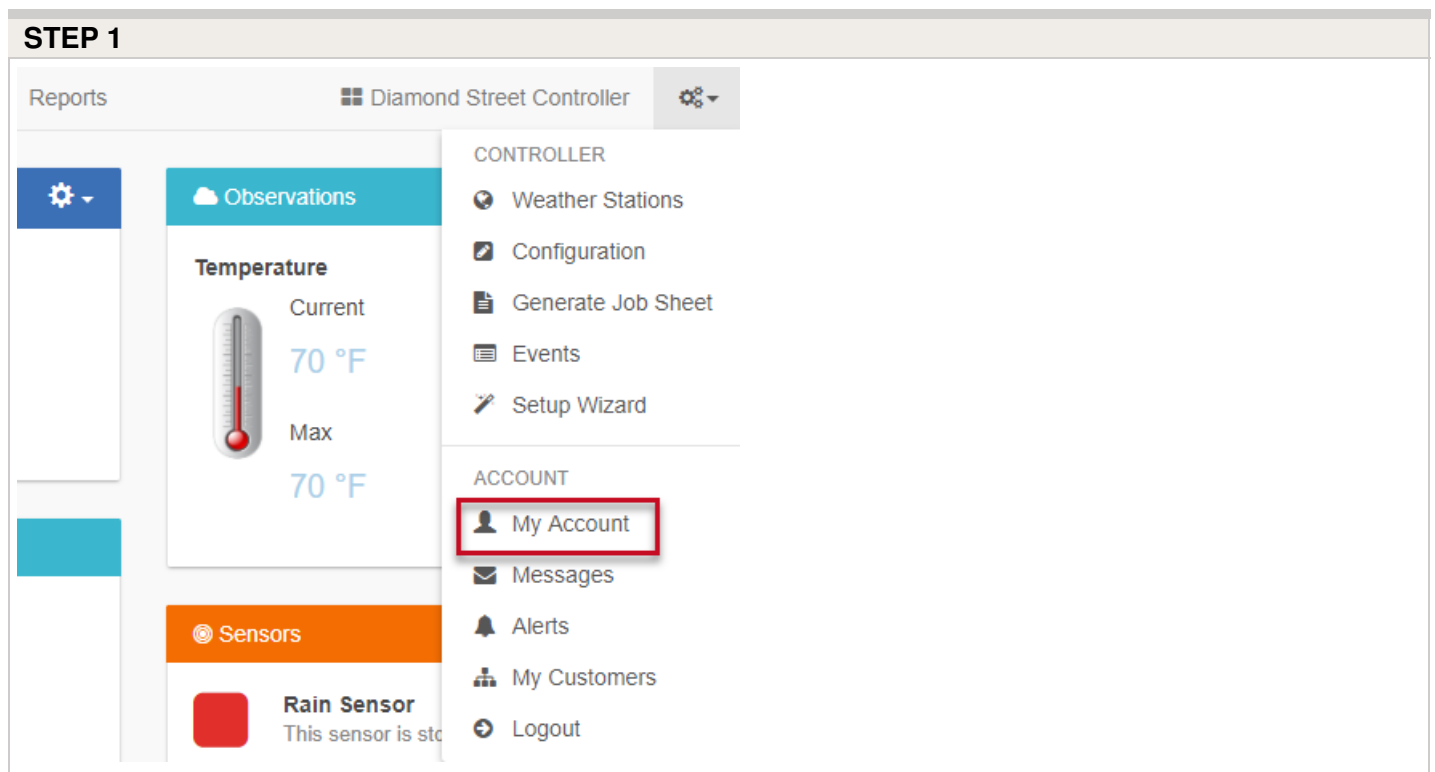

The screenshot shows a dashboard for a 'Diamond Street Controller'. On the left, there are navigation options for 'Reports', 'Observations', and 'Sensors'. The 'Observations' section displays 'Temperature' with 'Current' and 'Max' both at 70 °F. A 'Rain Sensor' is shown with the status 'This sensor is st...'. On the right, a settings menu is open, listing options under 'CONTROLLER' (Weather Stations, Configuration, Generate Job Sheet, Events, Setup Wizard) and 'ACCOUNT' (My Account, Messages, Alerts, My Customers, Logout). The 'My Account' option is highlighted with a red rectangular box.

**STEP 2**

USER SETTINGS

UNITS OF MEASUREMENT  
Fahrenheit & Inches

LANGUAGE  
English

Hunter Staff  
contractor1@hydrowse.com

STEP 3

Edit User

Name  
Hunter Staff

Email Address  
contractor1@hydrowse.com

Units of Measurement  
Fahrenheit & Inches

Change Password Cancel OK

# Account - Rename Controller

To rename your controller, please view the steps and screenshots to access this feature:

1. Click on **Settings > Configuration**, located on the top right of the Dashboard as shown below.
2. Once the configuration screen has loaded, click on the **Pencil** icon to edit the name.
3. When you have entered the new name for your controller, click **OK**.

## STEP 1

Reports Diamond Street Controller ⚙️

⚙️

**Observations**

**Temperature**

Current **70 °F**

Max **70 °F**

**Sensors**

**Rain Sensor**  
This sensor is st

**CONTROLLER**

- 🌐 Weather Stations
- 🔧 Configuration**
- 📄 Generate Job Sheet
- 📅 Events
- 🔧 Setup Wizard

---

**ACCOUNT**

- 👤 My Account
- ✉ Messages
- 🔔 Alerts
- 👥 My Customers
- 🚪 Logout

## STEP 2

**CONTROLLER**

🌐 **NAME**  
Hunter Industries

📄 **SERIAL NUMBER**  
virt4563 Remove Serial

🚪 **STATUS**  
Linked

🔧 **MODEL**  
HC 6 Zone Controller

🕒 **INSTALL DATE**  
Mon, 19 Sep 16 02:07:37 +0000

📄 **SOFTWARE**

🔧

## STEP 3

Empty area for Step 3 content.

Edit Controller Settings ✕

**Name**

**Model**

HC 6 Zone Controller Change

Cancel ✓OK

---

# Account - Add User/Files

## Add User

Both contractors and homeowners can add additional users to an account. However, as a home user, you must have an Enthusiast Plan to add additional users.

To add a user, please view the steps and screenshots to access this feature:

1. Click on **Settings > My Account**.
2. Next, scroll down to **My Account Users** and click **Add User**.
3. Fill in the required details and click **Create**. This will send a validation email to the user to activate the account. The user must create a password upon visiting the Dashboard for the first time.

**STEP 1**

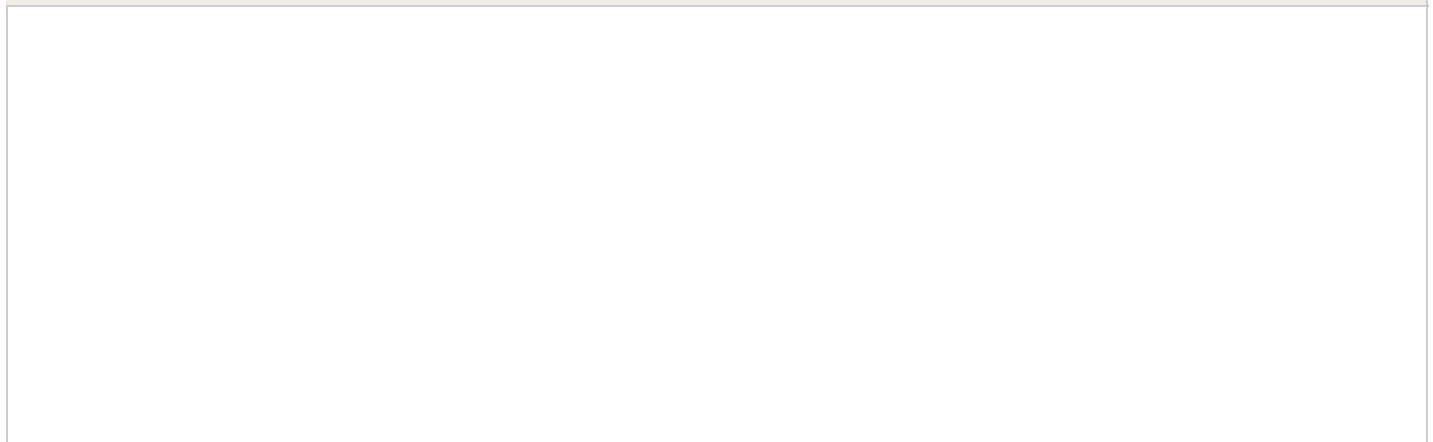



Reports Diamond Street Controller

### Observations

**Temperature**

Current  
**70 °F**

Max  
**70 °F**

**CONTROLLER**

- Weather Stations
- Configuration
- Generate Job Sheet
- Events
- Setup Wizard

---

**ACCOUNT**

- My Account**
- Messages
- Alerts
- My Customers
- Logout

### Sensors

**Rain Sensor**  
This sensor is st

## STEP 2

Add New User

## STEP 3

Add User
✕



Add picture

**Name**

**Email Address**

**Type of User**

Choose what the user can do in their account

Can modify configuration and run zones
▼

Cancel
OK

User Settings	
<b>Add Picture</b>	A image can be uploaded from you operating system.
<b>User Name</b>	The name of the new user
<b>Email Address</b>	The email address that the new user will use to log in to the account
<b>Type of User</b>	<ul style="list-style-type: none"> <li>If you want the user to have full control over the controller, select “Can modify configuration and run zones.”</li> <li>If you don’t want the user to have control over configuration, select “Can view configuration, manually run zones.”</li> </ul>

**IMPORTANT** You cannot add a user who already has an existing Hydrowise account. If the user has an account, email us at [support@hydrowise.com](mailto:support@hydrowise.com) [19]. We will delete the account from our system and you can then add the user accordingly.

## Files

Towards the bottom of the accounts detail page, you can upload files which are useful in managing your garden. For example, you might like to add a picture which shows the layout of your garden and zones. Uploading of files is supported for Enthusiast plan customers.

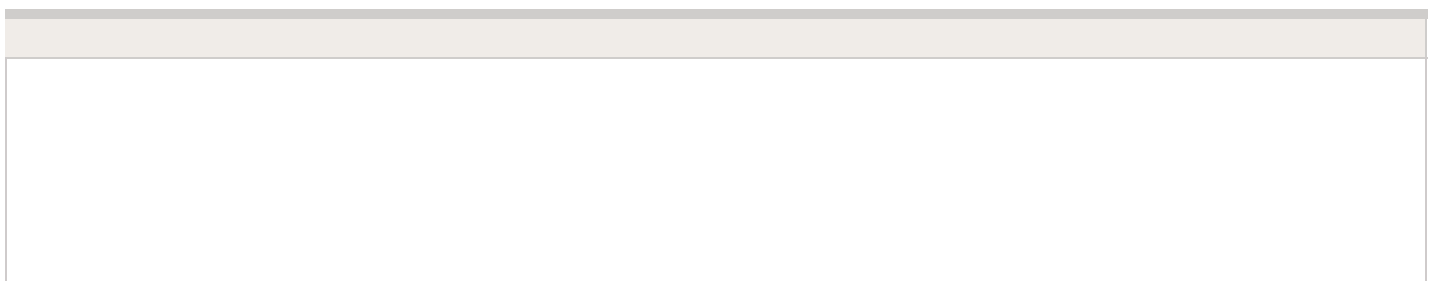

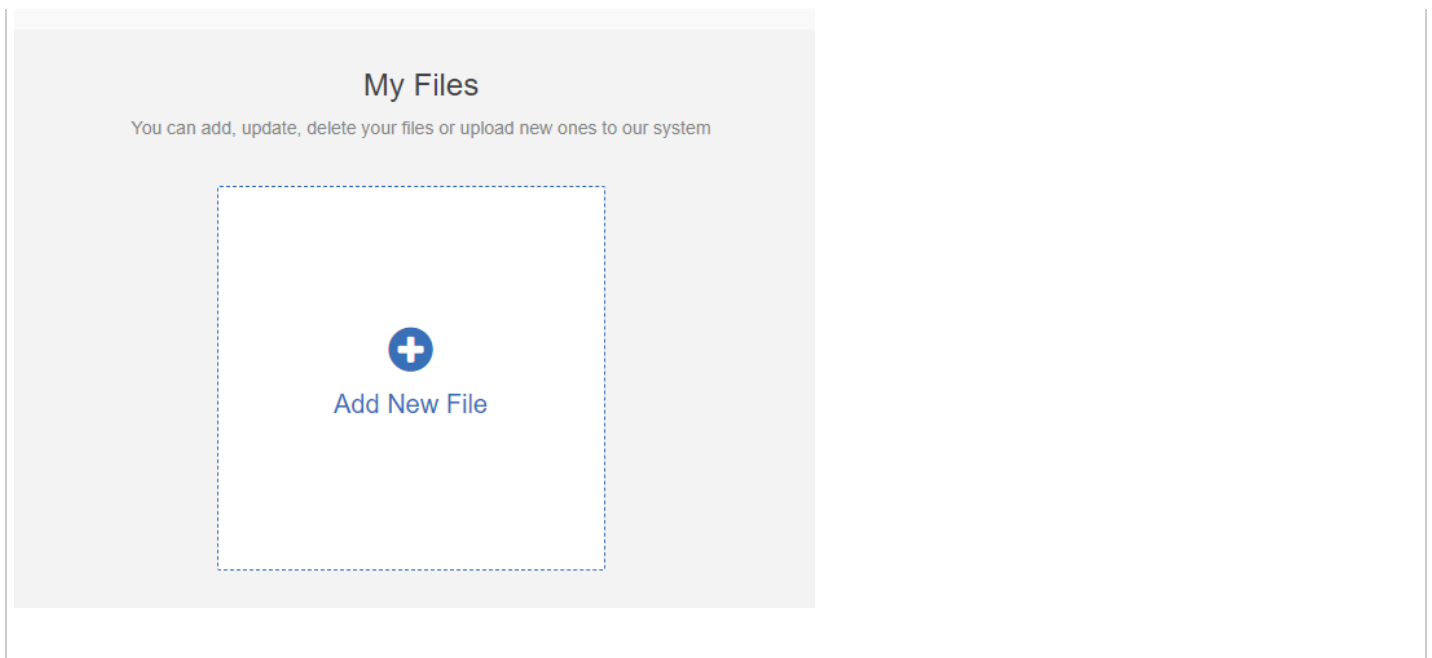

---

## Account - Setting Delay

To set a delay between your zones (inter-zone delay) or for a master valve/pump before the zone starts (master valve delay), please view the steps and screenshots to access this feature:

1. Click on **Settings > Configuration**
2. Next, scroll down to **valve delays** and click **pencil icon box**.
3. Enter the each **delay** required in seconds format and Click **OK**.

### STEP 1

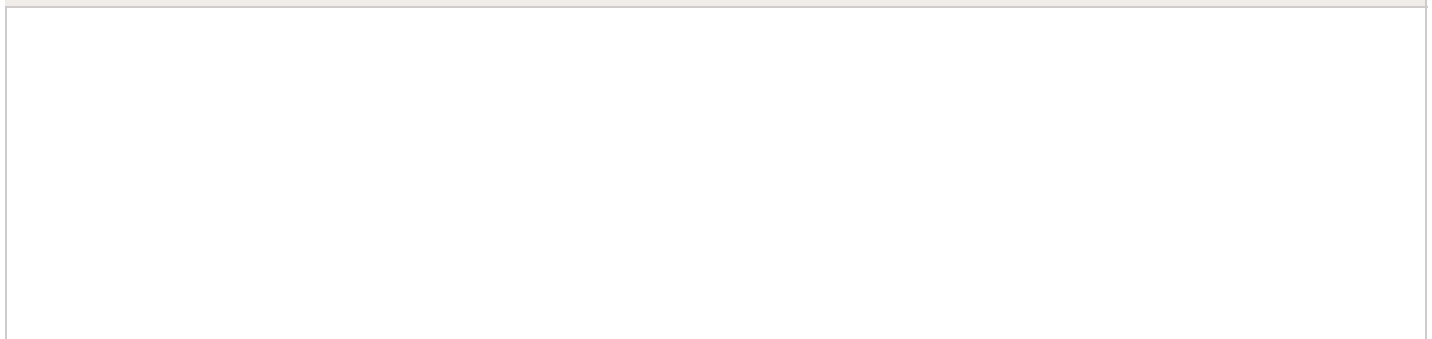

Reports Diamond Street Controller

Observations

**Temperature**

Current  
**71 °F**

Max  
**72 °F**

**Sensors**

**Rain Sensor**  
This sensor is st

CONTROLLER

- Weather Stations
- Configuration**
- Generate Job Sheet
- Events
- Setup Wizard

---

ACCOUNT

- My Account
- Messages
- Alerts
- My Customers
- Logout

### STEP 2

**REGIONAL SETTINGS**

TIMEZONE  
America/Los\_Angeles

---

**VALVE DELAYS**

INTER ZONE DELAY  
0 seconds

MASTER VALVE DELAY  
0 seconds

### STEP 3

Edit Valve Delays
✕

**Inter Zone Delay**

seconds

**Master Valve Delay**

seconds

Cancel

✔OK

Delay	Description	Max Delay
Inter-Zone Delay	The number of seconds between each of the zone run times.	3,600 Seconds
Master Valve Delay	The minimum number of seconds that the master valve should be active before any zone starts. Hydrawise on shut down always shuts the station valve 1 <sup>st</sup> and then about 1 second later shuts the master valve.	600 Seconds

Some watering systems require water pressure for a sprinkler head to pop up. This delay can be used to ensure that water pressure is built up or maintained before a zone starts watering (or before the next zone begins watering) by delaying the time the next valve opens, ensuring water pressure is present. Depending on your specified setup, these delays can be used to meet those requirements.

## Account - Exporting Reports

The instructions below will allow you to download the report chosen into an Excel document.

To download your reports in Excel, click on the **Reports Tab**. After highlighting one of the download options listed below, you can click the download tab to automatically save to a excel file on your computer.

### Download Options Include:

1. Day
2. Week
3. Month

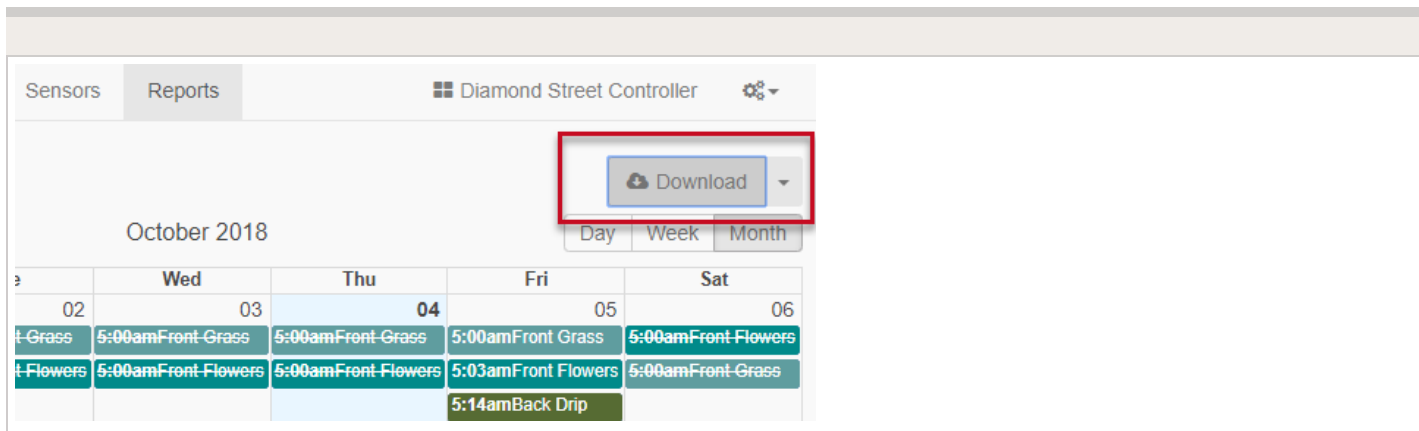

**NOTE:** The free Home Plan provides up to 30 days of reporting, and the Enthusiast Plan provides up to 365 days of reporting.

## Account - Editing Serial Number

This article will cover the following information on editing your controller's serial number.

1. Linking to your account (Setup wizard and Dashboard)
2. Unlink controller from your account

### Linking to Your Account

There are two locations where you can link your controller to your account:

- During the setup wizard (optional)

- From the controller **Dashboard**

**NOTE:** You only need to link your controller to your account once. If you provided a serial number when going through the setup wizard, you've successfully linked your controller to your account and you can ignore these instructions.

To link your controller through your account Dashboard, follow these steps:

- Log in to your account [10].
- On the Dashboard, click on the Settings icon located on the blue Watering Schedule bar. Then click the **Link to controller...** button.
- Enter your controller's serial number. The eight-character serial number is found on the side of the unit. The serial number is not case-sensitive.

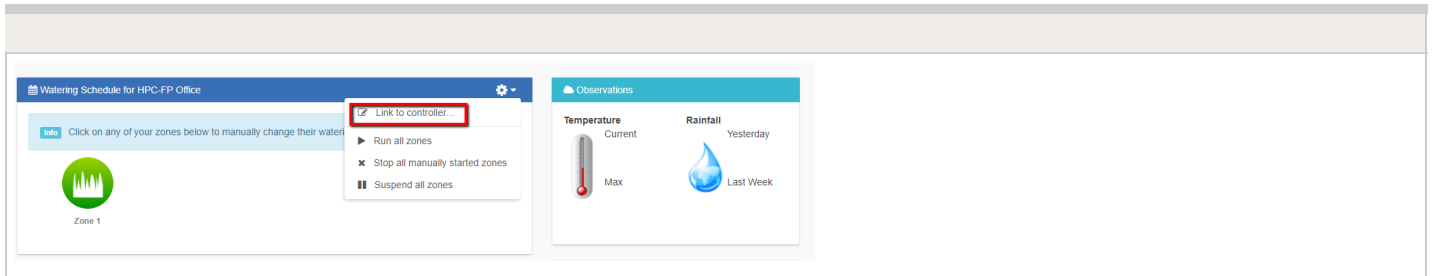

Once you've entered the serial number, your controller will automatically download your settings and begin watering based on your watering schedules.

## Unlink From Account

This is important if you wish you resell your controller or want to transfer ownership to someone else. This prevents the next user from getting the error message that the serial number they are trying to link to their account is already in use.

To unlink a controller, follow the steps below:

1. From your browser, go to the top right of your dashboard and click on **Settings**. From your smartphone app, click on **More**. Then click on **Configuration**.
2. On the next screen, locate your serial number. Then click **Remove serial**.

### STEP 1

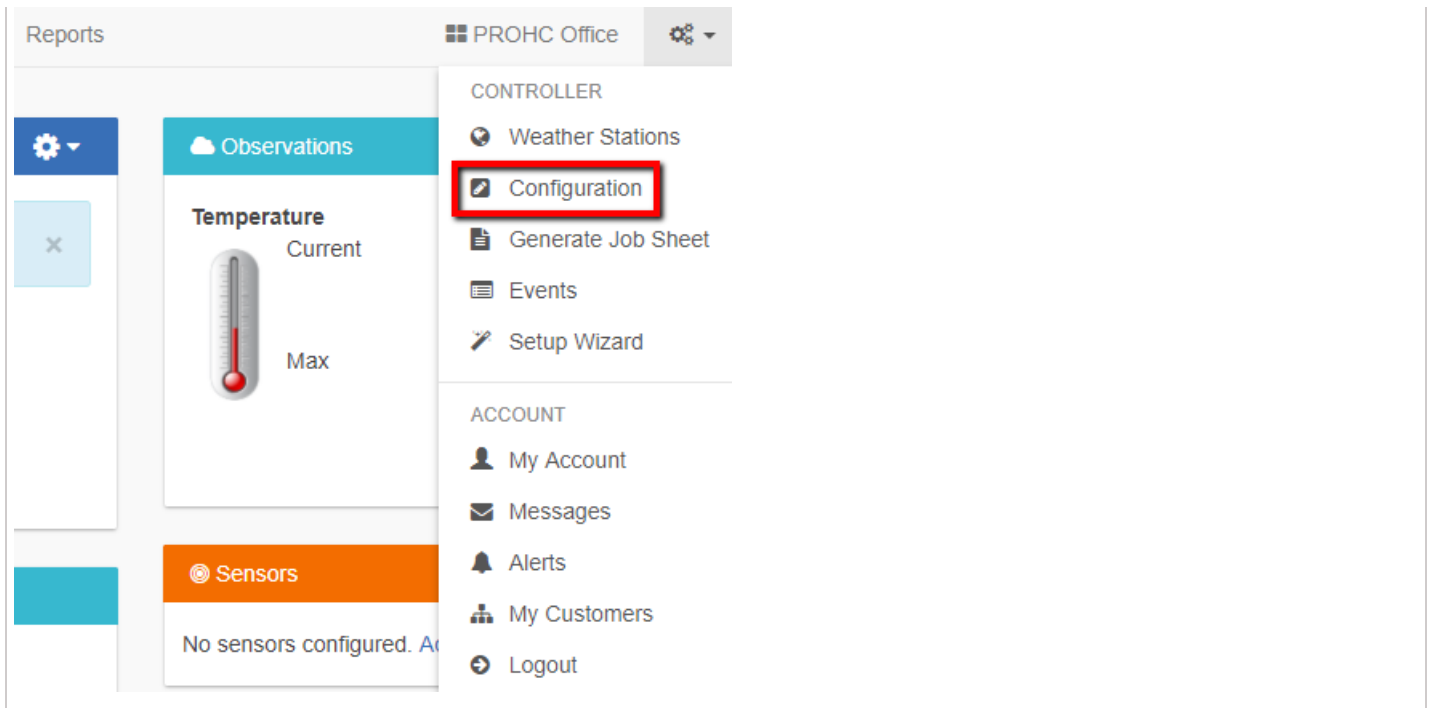

## STEP 2



NOTE: This is helpful if you are either using controller on another site or replacing under warranty.



# Account - Resetting Password

If you registered using your email address (i.e., not using the Facebook option), click on **Forgot password?** from the login screen.

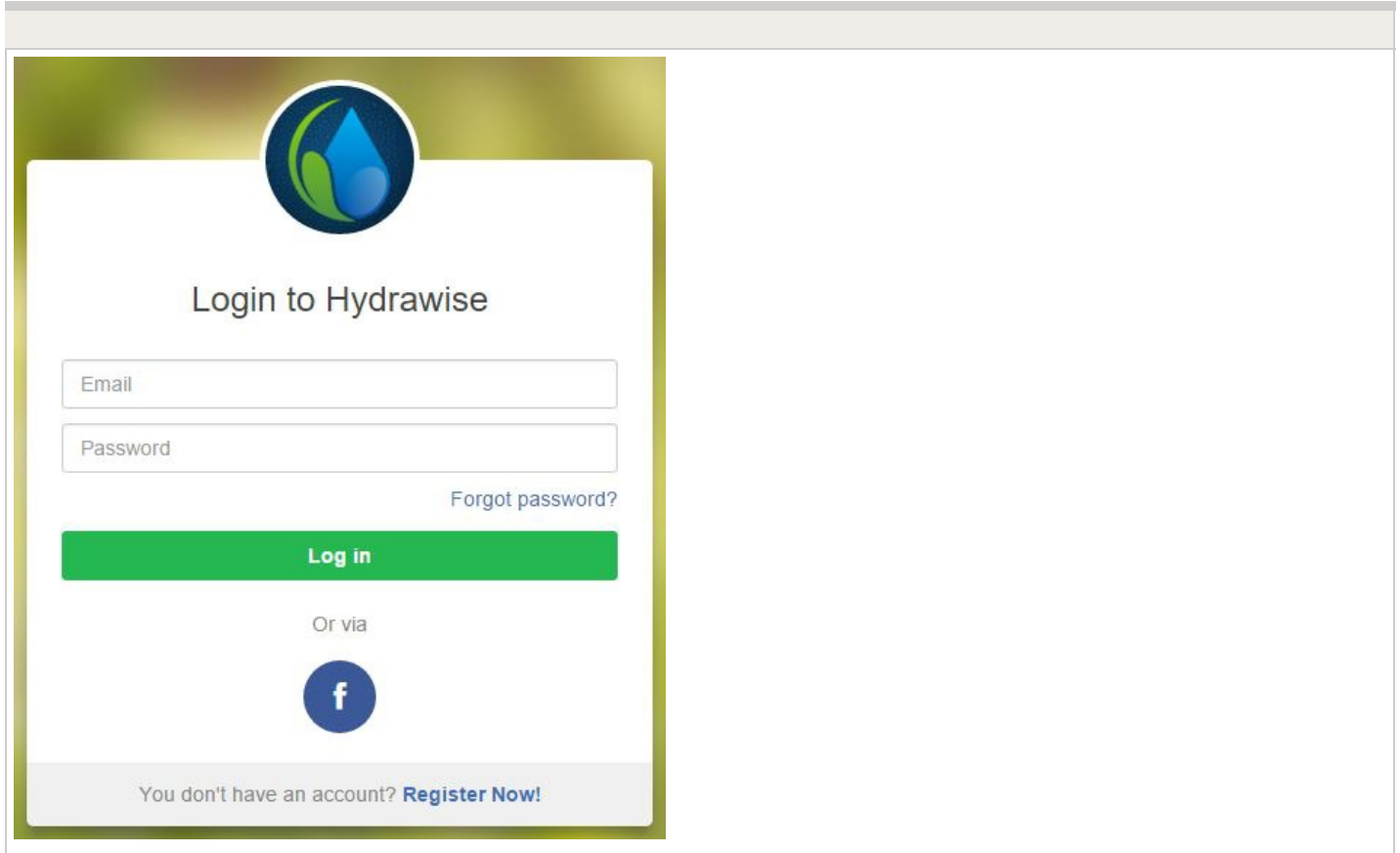

The image shows a login form for Hydrowise. At the top is a circular logo with a blue water drop and green leaves. Below the logo is the text "Login to Hydrowise". There are two input fields: "Email" and "Password". To the right of the password field is a link that says "Forgot password?". Below the input fields is a green button labeled "Log in". Underneath the button is the text "Or via" followed by a blue circular icon with a white "f" (Facebook). At the bottom of the form is a link that says "You don't have an account? Register Now!".

On the next screen, simply type in your registered email address and click **Reset Password**. You will then receive an email. Click the password reset link and enter in your new password. Confirm the password and you should be good to go again.

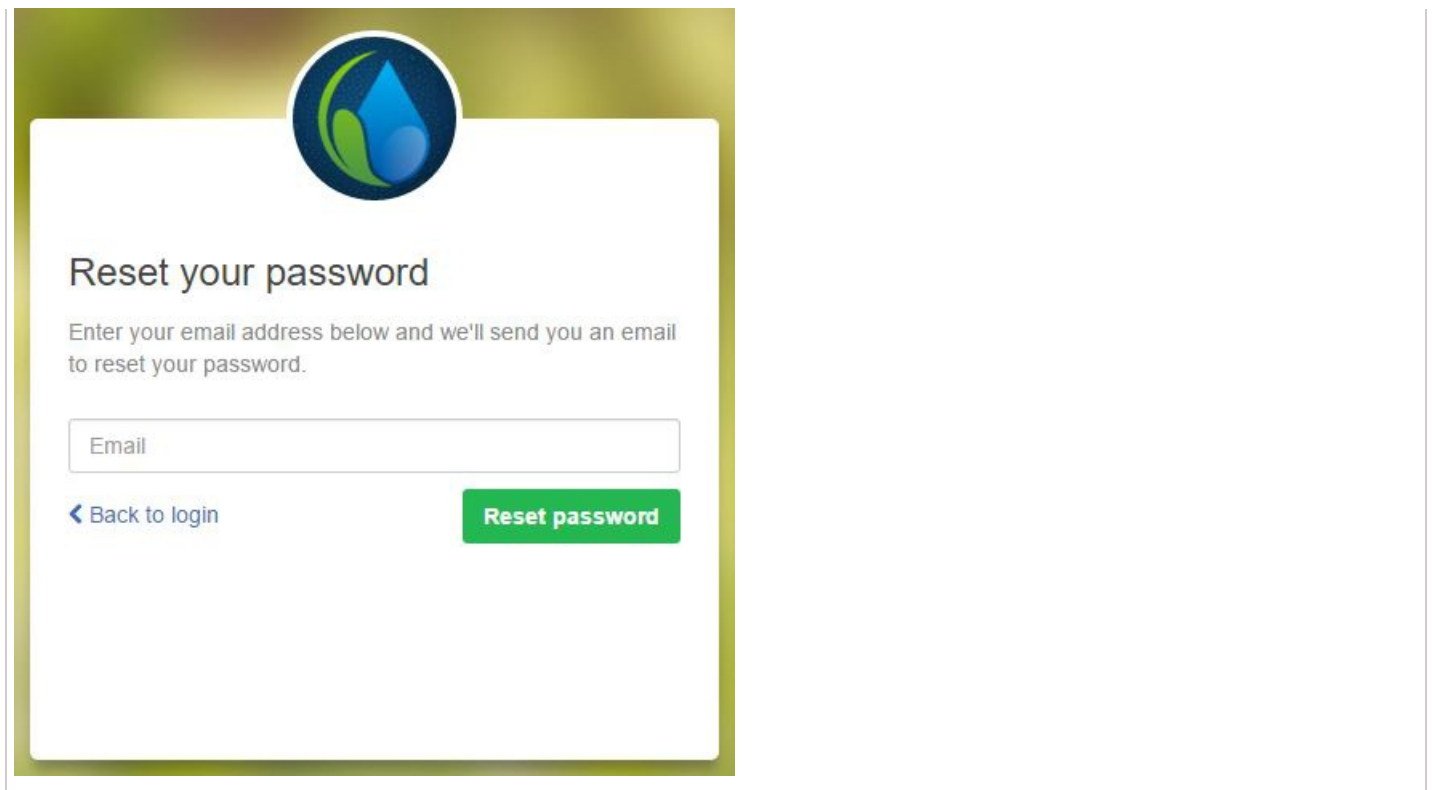

If you are having issues logging in to Facebook using the application, follow this guide to reset your password: [Unable to Log In Using Facebook App](#) <sup>[33]</sup>. Don't worry; you won't lose any settings.

---

## Account - Not Receiving Hydrowise Activation Emails

We're sorry that you have not yet received an activation email from [support@hydrowise.com](mailto:support@hydrowise.com) <sup>[34]</sup>. We use a third-party company to ensure our email has the best chance of getting to you.

The following tips will help you verify if the email was delivered. First, check your deleted items to see if the email was inadvertently deleted. If it was, move the email back to your inbox.

Next, look in your spam, trash, or junk folders. The email may have been sent to one of

these folders due to email filters. If the email is in one of these folders, right click on the email and select “trust sender” or “always allow email from sender.”

We recommend that you add [support@hydrawise.com](mailto:support@hydrawise.com) <sup>[34]</sup> to your “safe senders,” “allowed,” or “trusted” email list. Depending on your email service provider, you can do this in several ways. Below are shortcuts to some popular providers:

[Outlook](#) <sup>[35]</sup>

[Gmail](#) <sup>[36]</sup>

[Apple](#) <sup>[37]</sup>

Hydrawise does not use your email address for marketing purposes. To view our terms and conditions and privacy policy, visit [www.hydrawise.com](http://www.hydrawise.com) <sup>[38]</sup>. Please contact us if you have questions.

---

# Configuring - Several Watering Lengths One Zone

You will now learn how to achieve different watering times using one zone (or many zones, if you understand the concept of stacking start times).

Stacking start times means creating Program Start Times one after the other based on the duration of the watering length set for each zone.

For example, if you wanted Zone 1 to run for 10 minutes in the morning and 30 minutes in the evening, you would have to set up Zone 1 with a watering length of 10 minutes. Then you would use Program Start Times to achieve the watering times you want.

**NOTE:** You must use “Every Valid Program Start Time” to achieve this goal, as the Program Start Time dictates when the zone is allowed to water.

A typical zone would be set this the example below:

Example 1

**Front Lawn**  
Zone Number - 1

**Watering Type**  
Time Based

**Frequency**  
Every valid Program Start Time

**Schedule Adjustments**  
Water longer when hot

**Run Length**  
10 mins

To water for 10 minutes in the morning, you would create one start time at 7 a.m., for example, that allows Zone 1 to run for 10 minutes.

### Example 2

07:00

TYPE

Selected days of week

SN M T W TH F S

ZONES

Front Lawn

For Zone 1 to run for 30 minutes in the evening, you will need to stack start times. For

example, you will need to create program start times for Zone 1 at 7 p.m., 7:10 p.m., and 7:20 p.m., so the zone runs for a total of 30 minutes.

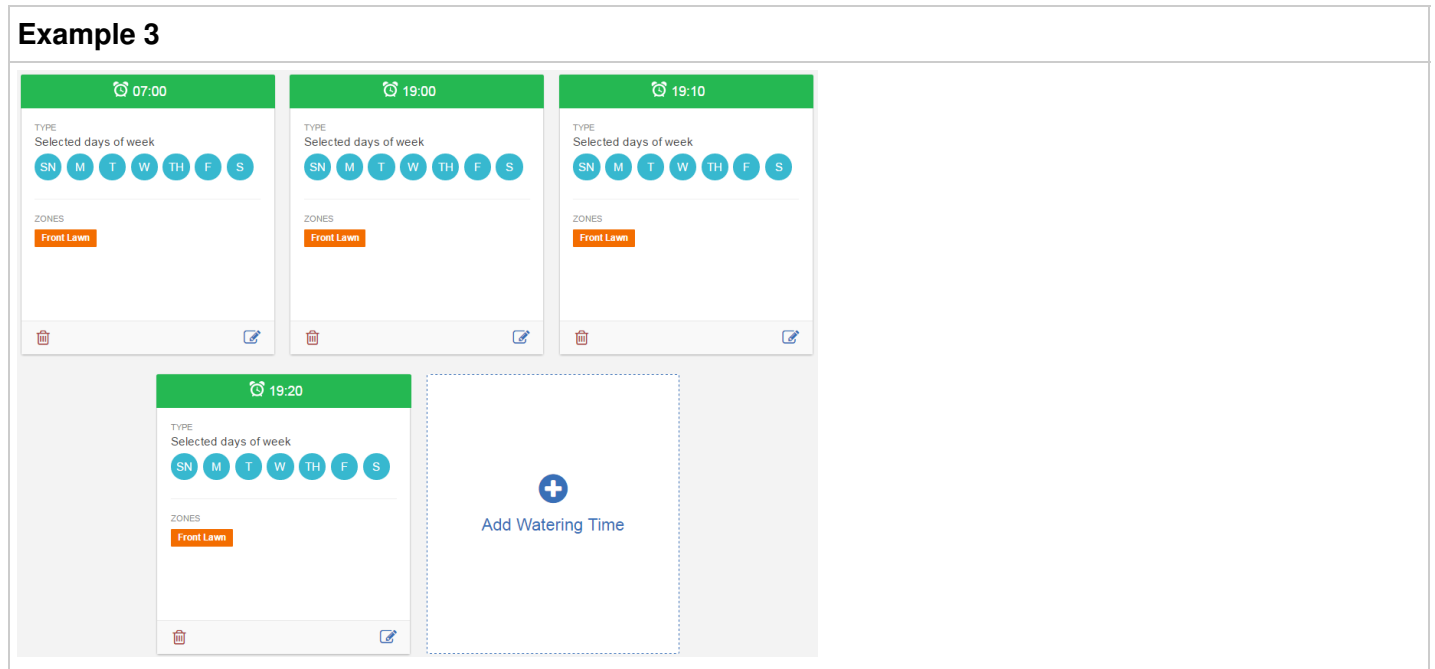

By having the program start times dictate when zone one is allowed to water, we have achieved 10 minutes of watering in the morning and 30 minutes of watering in the evening without modifying the irrigation zone's configuration. See below for what the schedule will look like.

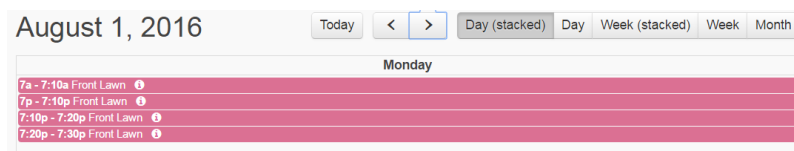

You can see there are 10 minutes of watering at starting at 7 a.m. Then, starting at 7 p.m., there is a total of 30 minutes of watering as a result of stacking your Program Start Times.

**IMPORTANT:** This method only applies with **Predictive Watering™** and will not work with Smart Watering. The water trigger "Water More Often When Hot [15]" will not also work if you want to use this method, as it uses "Every Valid Program Start Time."

## Configuring - Pre-configured

# Schedules

Preconfigured Watering Schedules allow you to group together zones with identical watering properties. Each Preconfigured Watering Schedule determines how long a group of zones will run and how the schedule should be modified based on your local weather. Zones will water only at your defined Program Start Times.

To add a preconfigured watering schedule, please view the steps and screenshots to access this feature:

1. Navigate to the **Zones & Schedules** in your Hydrowise account on the dashboard
2. Click on **Add Watering Schedule**.
3. Add a **Schedule name** and choose a **watering type**. The example below will be the most common which is Time Based.
4. Finally, add **watering length, frequency**, and the **predictive watering adjustments**.
5. Click **OK**.

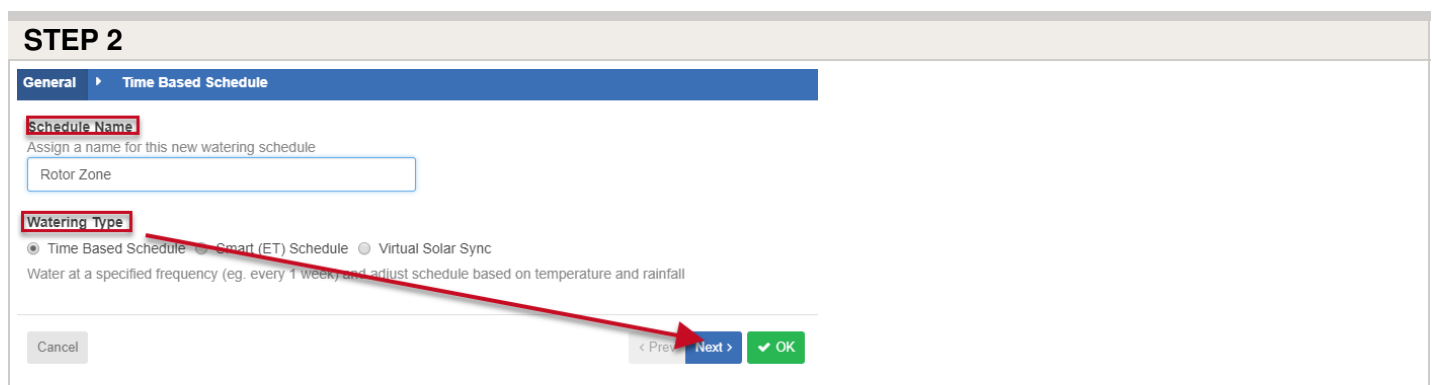
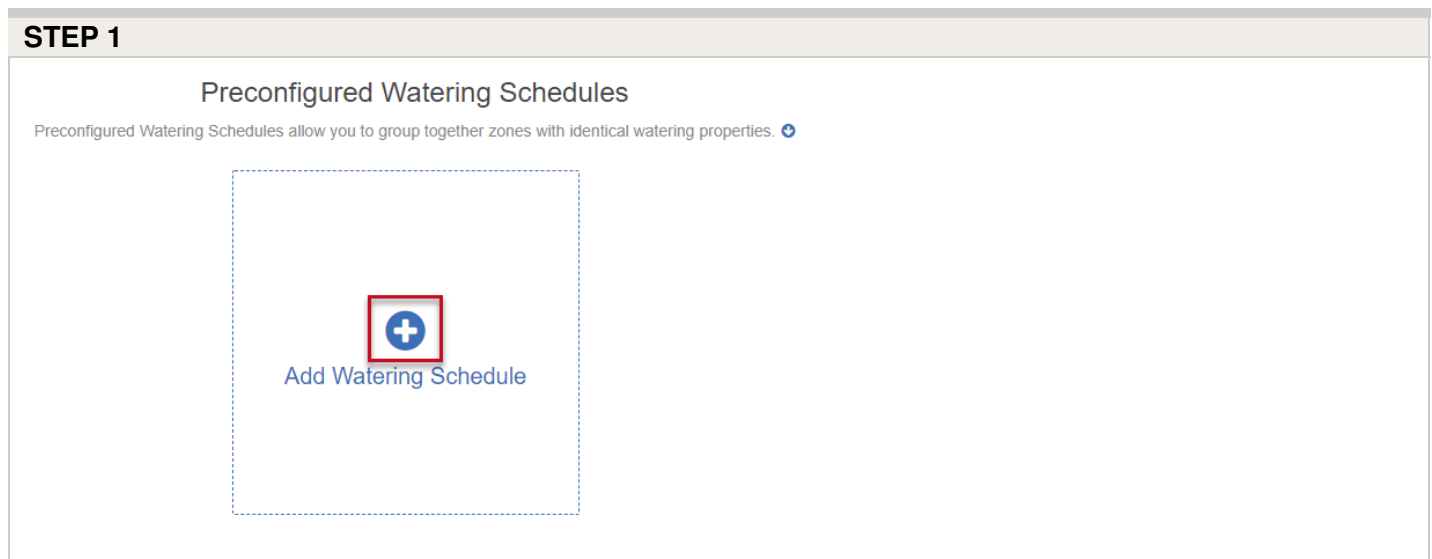

## STEP 3

**General** ▶ **Time Based Schedule**

**Watering Length**  
The number of minutes this zone will run for each time  
 minutes

**Watering Frequency**  
Choose how often each irrigation zone associated with this Watering Schedule will run  
 Every Program Start Time  Interval Based Watering

**Predictive Watering™**  
Adjust watering based on the following triggers

Don't water when:

- Forecast below 60°F
- Wind above 9mph
- 3in+ rainfall last 7 days
- 80%+ chance of rain
- 0.5in+ rainfall last day

Adjust watering:

- Water 30% less when below 73°F
- Water longer when hot
- Water more often when hot

[Edit monthly adjustments \(advanced\)](#)

Cancel

## Example Schedules

**Preconfigured Watering Schedules**

Preconfigured Watering Schedules allow you to group together zones with identical watering properties.

**Lawn**

**RUN TIME**  
20 mins

**WATERING FREQUENCY**  
Twice a day

**SCHEDULE MODIFICATIONS**  
Water more often when hot

**Lawn 1**

**RUN TIME**  
10 mins

**WATERING FREQUENCY**  
Twice a day

**SCHEDULE MODIFICATIONS**  
Water more often when hot

**Time Based**

**RUN TIME**  
15 mins

**WATERING FREQUENCY**  
Three times a day

**SCHEDULE MODIFICATIONS**  
Water more often when hot

**Water Longer**

**RUN TIME**  
180 mins

**WATERING FREQUENCY**  
Every valid Program Start Time

**SCHEDULE MODIFICATIONS**  
Water longer when hot

**Water More**

**RUN TIME**  
180 mins

**WATERING FREQUENCY**  
Four times a day

**SCHEDULE MODIFICATIONS**  
Water more often when hot

**+**  
Add Watering Schedule

Watering Schedules can be used for zones that are running either Time-Based Predictive Watering or Smart Watering. However, for Smart Watering zones the Schedule Adjustment option in a preconfigured Watering Schedule is not used. For more information, see [Configuring Irrigation Zones](#) [2].

Each Watering Schedule contains the following settings:

<b>Schedule Name</b>	This is the name of the Watering Schedule
<b>Run Time</b>	This is the watering time for this landscape type under normal conditions (if it is too hot or cold, this value will be automatically adjusted)







Scroll to bottom of **"zones and schedules"** to create a 2nd start time.

1. Choose the plus sign for **"Add watering Time."**
2. Choose a **"second start time"** and click **"next."**
3. Make sure you apply to the correct zones and click **"ok."**
4. In the **"water trigger"** section, set the one trigger highlighted accordingly.

**IMPORTANT:** Make sure you have all zones selected for the start times created (or, at the very least, the zone you intend to "Water More Often When Hot").

**STEP 1**

### Program Start Time

Watering Program Start Times are listed below. These times specify when your controller is permitted to

5:00am

TYPE  
Normal watering time (every week)

SN M T W TH F S

ZONES  
All Zones

+

Add Watering Time

## STEP 2

**Set Time** ▸ **Select Zone**

**Start Time**  
Enter the time for this Program Start Time  
06:00 PM

**Watering Type**  
Normal watering time (every week) ▾  
Normal watering is permitted to start at this time

**Watering Days**  
Select the days of the week to water  
Selected Days of the week ▾

S  N  M  T  W  TH  F  S

## STEP 3

**Set Time** ▸ **Select Zone**

**Select Zones**  
Applies to all zones ▾  
This program start time can be used by all zones

## STEP 4

**Predictive Watering™ Adjustments**  
Manage your watering based on weather forecasts. Choose which adjustments to apply when editing a zone.

The screenshot displays five adjustable sliders for predictive watering. Each slider has a green toggle switch on the left and a blue dot on a horizontal scale. The scales are labeled with 0 F, 130 F, 0 mph, or 100 %.

- Slider 1:** "Don't water when today's forecast temperature is less than" with a value of 60 F.
- Slider 2:** "Water 30% less when today's forecast temperature is less than" with a value of 73 F.
- Slider 3 (highlighted with a red box):** "Water 100% more when today's forecast temperature is above 90 F and humidity is below 100%".
- Slider 4:** "Don't water when the chance of rain is higher than" with a value of 80 %.
- Slider 5:** "Don't water when today's forecast wind speed is higher than" with a value of 62 mph.

You can set the trigger up however you like. See below for this example:

When you check your **Watering Schedule** on the days that meet your watering triggers, extra watering will occur. For example, you will notice all watering that has been set to start at 6p.m. is "extra watering due to temperature."

Setting your frequency affects how this feature works. For it to work correctly, you must always have an extra program start time that is above your watering frequency. In our example, we used "water once a day" and created two program start times so extra watering can occur once. If you want to change this, you must ensure the above is met. For instance, if you have set watering to twice a day, you must create three program start times for the third program start time (the extra watering schedule) to take effect.

The screenshot shows a notification box overlaid on a watering schedule. The notification reads: "Extra watering cycle due to temperature", "Time: Mon, 7:07pm", and "Length: 5 minutes". Below the notification, the schedule shows several entries for "Front Flowers" and "Front Grass" with start times like "7:07a", "7p", and "7:07p".

**NOTE:** Due to changes made to this setup, the extra zones do not show on the above screenshot because those are passed events on my watering schedule. At this time, due to weather changes, no extra watering has been scheduled. Thus, only past events were used in this example.

**IMPORTANT:** To ensure that "Water More Often When Hot" works, you need to have an extra program start time that is above your watering frequency. If you select "Every Available Program Start Time" as a watering frequency, this feature will not work because watering is already scheduled for all program start times.

**The general calculation is:**

<number of times per day> multiplied by (1 + <trigger percentage>) = number of watering times for the day (rounded down)

So, for once a day and a 50% trigger, the calculation is:

$1 \times (1 + 0.5) = 1.5 =$  once a day (rounded down)

Twice a day multiplied by (1 + trigger percentage) could be greater than 2 if the percentage is greater than 50%:

$2 \times (1 + 0.5) = 3 =$  3 times a day

Twice a day multiplied by (1 + trigger percentage) with a trigger percentage of 100% would give you 4 times a day:

$2 \times (1 + 1) = 4 =$  4 times a day

**IMPORTANT:** If you require multiple watering's per day, this is the one situation where low-priority watering times are useful. You could have a normal watering time of 6 a.m. and 6 p.m. and a low-priority time of 12 p.m., which will get used only if you are watering more often and you need a third cycle for the day.

Please feel free to test this setup as you see fit for your watering needs. Should you have further questions, send an email to [support@hydrawise.com](mailto:support@hydrawise.com) [19].

---

# Configuring - Trigger "Water

# Longer When Hot"

The **"water longer when hot"** feature will allow the end user to water the zone longer based on the percentage set in the water trigger. This is only available when using **Time Based Watering type**. Please view the steps and screenshots to access this feature:

Click on **"Zones and Schedules"** from the home dashboard. Scroll down to the first zone you choose to edit. Click on the  icon.

1. Choose the watering type **"Time Based Schedule"** and click **"next."**
2. Check the adjust watering feature **"water longer when hot"** and click **"ok."**

**STEP 1**

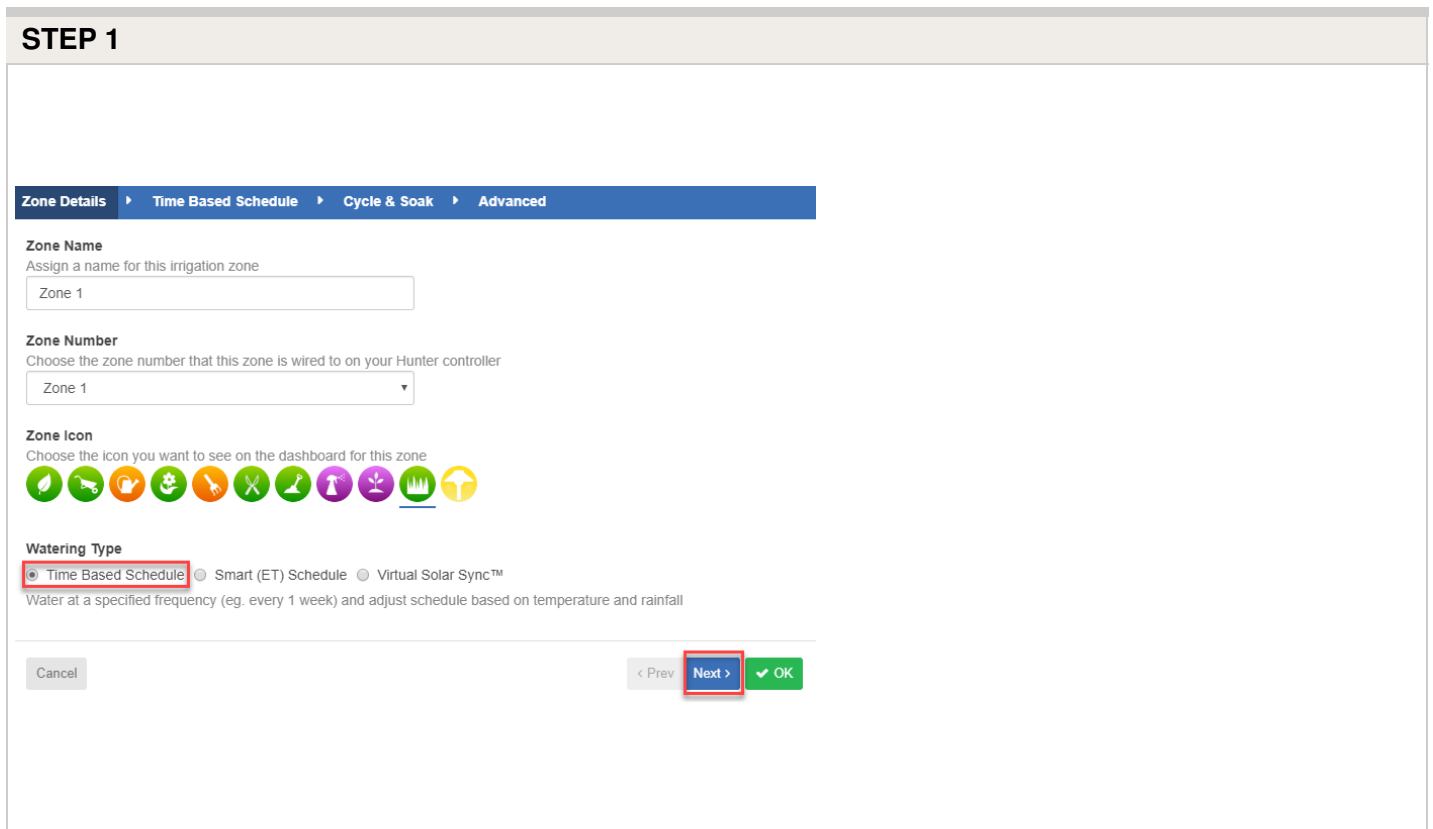

Zone Details ▶ Time Based Schedule ▶ Cycle & Soak ▶ Advanced

**Zone Name**  
Assign a name for this irrigation zone  
Zone 1

**Zone Number**  
Choose the zone number that this zone is wired to on your Hunter controller  
Zone 1

**Zone Icon**  
Choose the icon you want to see on the dashboard for this zone  

**Watering Type**  
 Time Based Schedule  Smart (ET) Schedule  Virtual Solar Sync™  
Water at a specified frequency (eg. every 1 week) and adjust schedule based on temperature and rainfall

Cancel < Prev **Next >** ✓ OK

**STEP 2**

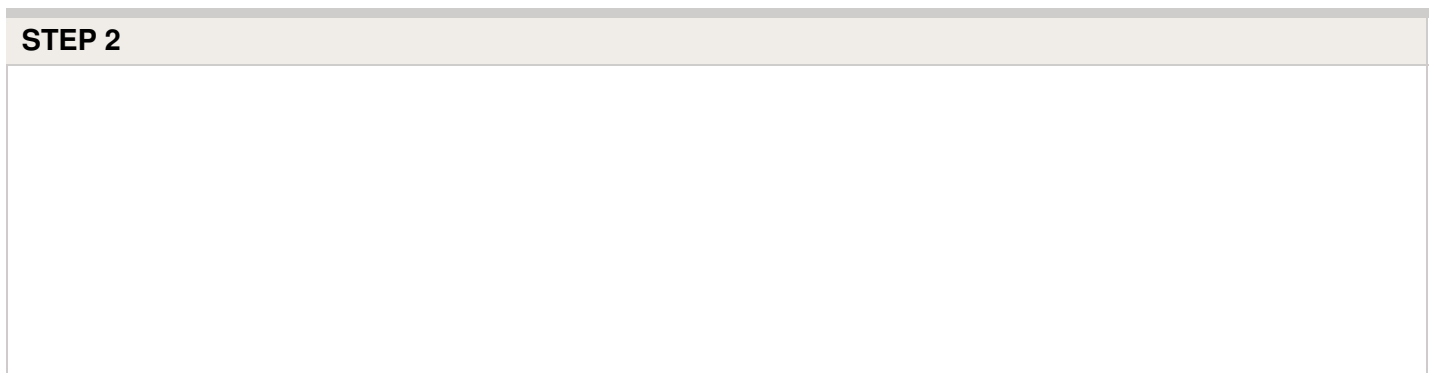

Zone Details > Time Based Schedule > Cycle & Soak > Advanced

**Watering Type**

Enter Time and Frequency below  
 Use a Preconfigured Watering Schedule

**Watering Length**  
The number of minutes this zone will run for each time  
 minutes

**Watering Frequency**  
Choose how often this zone should run  
 Every Program Start Time  Interval Based Watering

**Predictive Watering™**  
Adjust watering based on the following triggers

Don't water when:

- Forecast below 60°F
- Wind above 62mph
- 3in+ rainfall last 7 days
- 80%+ chance of rain
- 0in+ rainfall last day

Adjust watering:

- Water 30% less when below 73°F
- Water longer when hot**
- Water more often when hot

[Edit monthly adjustments \(advanced\)](#)

Cancel < Prev Next >

# Setting Trigger

1. Click on the default "100%" from the top right water trigger.
2. Adjust the "percentage" needed to water more and click "ok."
3. Click "Submit."
4. Using the slide bar, choose the "temperature" threshold.

**NOTE:** As an example, the zone using this trigger will water 15% longer when the temperature outside is above 85 degrees.

## Setting Trigger: STEPS 1-3

### Predictive Watering™ Adjustments

Based on weather forecasts. Choose which adjustments to apply when editing a zone.

Water % less when today's forecast temperature is less than

**73 F**

F  F

Water

Cancel

% more when today's forecast temperature is above

**90 F** and humidity is below %

F  F

## Setting Trigger: STEP 4

### redictive Watering™ Adjustments

Based on weather forecasts. Choose which adjustments to apply when editing a zone.

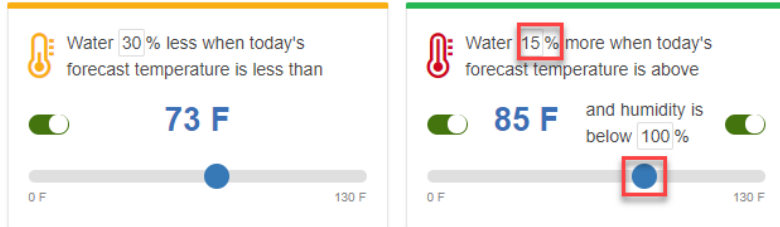

# Smart Watering - Quick Reference

How Does it Work?	Description
When does it water?	Waters when estimated moisture level reaches 0% in zones and schedules.
Choosing Run Times	See run time calculator <a href="#">here</a> [30] or consult with local contractor/distributor.



How is ET calculated?	The calculation is done through the run times and the last 10 years of ET history based on the hottest time of the year for that location.
Forecasting High Temperature	Forecast three days in advance.

Programming: Zones and Schedules	Description
Enter Watering Length	Enter the number of minutes you want the zone to run (hottest time of the year)
Enter Peak Watering Frequency	Enter the time between watering in the peak of your irrigation (hottest time of the year) Example: 1 day interval means the system will water every day in the summer schedule.
Next Available Start Time Box	Checking this box will reset the smart water balance to 0. If this box is not checked when changing from time based to smart watering then the bar will automatically be at 100%.
Cycle/Soak	This helps reduce runoff by running small increments with same total run time. This is used instead of soil type and slope. <i>Example:</i> Station 1 requires 20 minutes of watering, but after 5 minutes, runoff occurs. However, after 10 minutes all the water is absorbed. The solution would be to program 20 minutes for the station run time, 5 minutes for the Cycle time, and 10 minutes for the Soak time.
Advanced	Fine tuning: This feature is designed to slow down or speed up the drying process. If the soil is too wet, then we allow it to dry for longer, too dry, smart watering will allow less drying time.

**Example:** If we have every 2 days set as the frequency, this is not the minimum frequency as it is merely a reference point based on the driest time of the year. If we experience a drier time, we may need to water each day. Likewise, if we have a wetter time the frequency will increase, allowing for more time between watering.

Water Triggers	Description

Use forecast temperature to predict Smart Watering	This trigger allows frequency adjustment based on the current season.
Use forecast rainfall to delay Smart Watering	This feature assists in delaying irrigation when rain is predicted.

# Smart Watering - Adjustment and Changes

**Smart Watering** is an automated watering schedule that uses information about environmental conditions to ensure your plants get the optimum amount of water. Evaporation will draw moisture from your garden, while rainfall and irrigation will add moisture. Understanding these conditions allows Hydrowise to decide when the time is right to water your garden.

**NOTE:** This calculation occurs in the background and may not always be reflected when checking reports or viewing your **Dashboard**. However, the feature does work and is reliable even if you can't visibly see these calculations.

In this example, there are two Smart Watering zones highlighted in red:

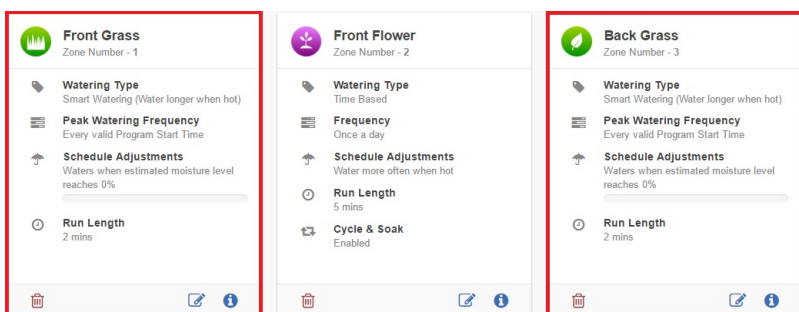

The **Watering Triggers** use Smart Watering Adjustments and have been left as default, with both switched on:

**NOTE:** If you turn off "Use forecast temperature to predict Smart Watering," your Smart Watering zones will not water. This is because all calculations have been switched off, and Smart Watering is calculated using weather data to predict estimated soil moisture balance. You can use this feature when you don't want any watering to occur without having to suspend your Smart Watering zones.

The second option, "Use forecast rainfall to delay Smart Watering," assists with delaying irrigation when rain is predicted. Refer to the example below to see how this is affected when it is turned off.

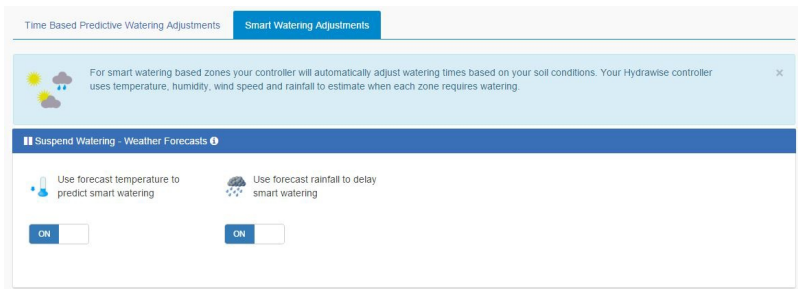

This is what your watering schedule will look like with these settings are combined with the weather forecast from your selected weather station.

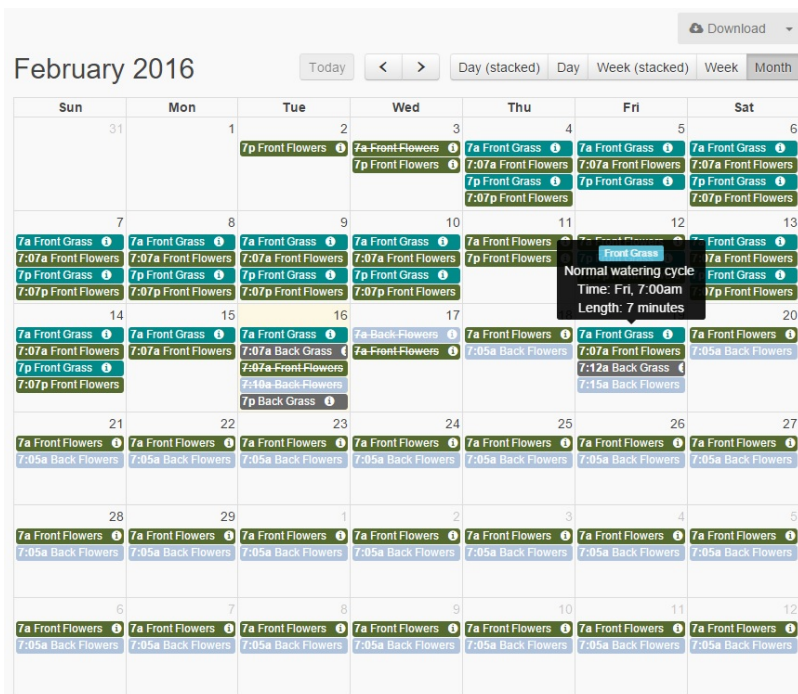

Now if we are to change the watering trigger on the second option to off as shown below:

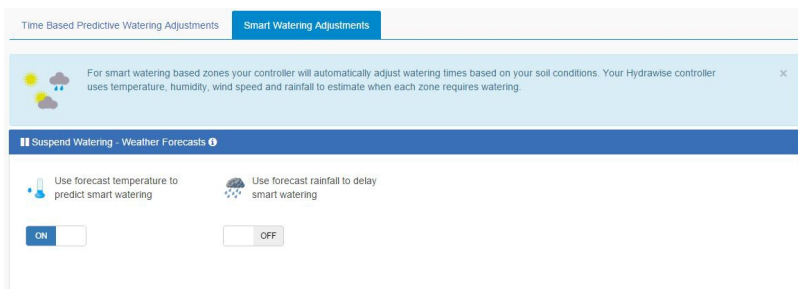

You will notice when checking your watering schedule that it has been changed to water a day earlier on both zones. This is because the trigger "Use forecast rainfall to delay Smart

Watering" is on (this is based on the calculations from the weather station; there is rain predicted on 18th). It has not been scheduled to water on that day, and watering has been pushed to the 19th. However, since we turned off this feature, watering will occur regardless if rain is predicted.

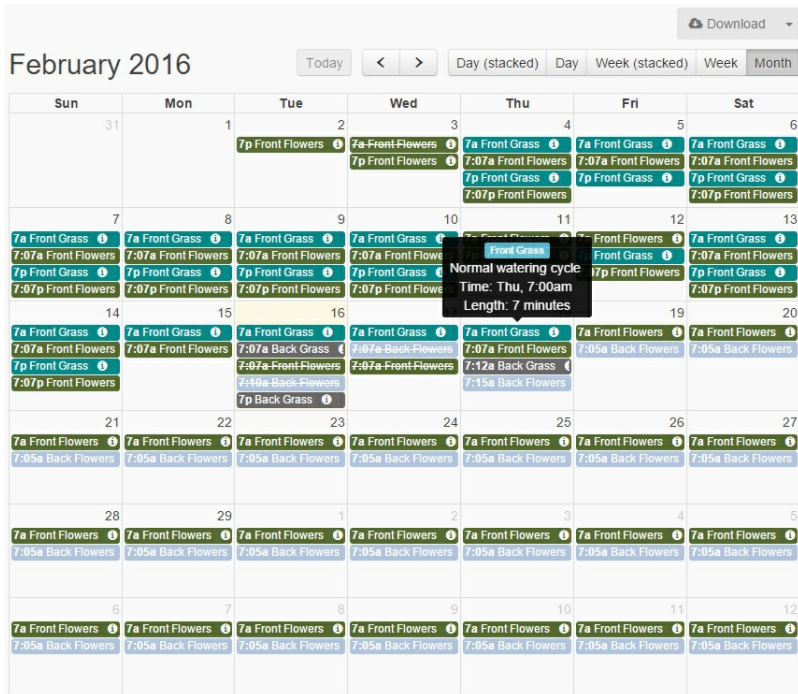

**IMPORTANT:** Some things to keep in mind when using Smart Watering:

Remember that Smart Watering schedules are based on estimated soil moisture balance and how you specify the watering length and peak watering frequency. Thus, the higher your estimated soil moisture balance, the less likely a smart watering zone will be scheduled to water. More importantly, please remember that Smart Watering only forecasts three days in advance. If there is no watering scheduled during the next three days, you will see **Not Scheduled** next to **Next Run** when you highlight over your Smart Watering zone on your dashboard.

- If you choose to change the watering time, you can always go to the tuning tab on any zone for both Smart Watering and Time-Based **Predictive Watering™** to modify watering length as shown below:

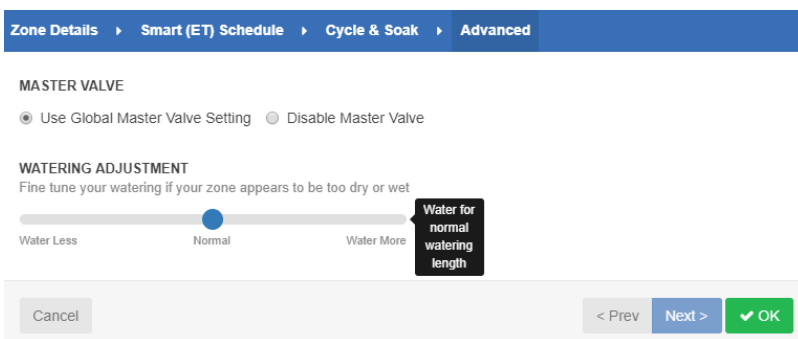

Please refer to the link above to gain further understanding of smart watering, if needed. If you have further questions regarding this feature, email us at [support@hydrawise.com](mailto:support@hydrawise.com) [19].

A final note: Although both Smart Watering and time-based **Predictive Watering™** achieve similar water savings due to “predictive weather” watering triggers, time-based watering is easier to understand and adjust.

---

# Offline Mode - Accessing Offline Mode

## Offline Mode

If the controller loses its internet connection for more than 24 hours, you'll receive a notification email. The controller will then go into offline mode. In offline mode, your controller won't be able to access local weather conditions such as rainfall or evaporation. As a result, it will revert to a predefined program.

- For **Smart Watering** zones, the controller will adjust each zone's watering length based on your offline watering budget and will water at each zone's configured peak watering frequency.
- For **Time-Based Watering** zones, the controller will adjust each zone's watering length based on your offline watering budget and will water at each zone's configured watering frequency.
- Note that **Cycle and Soak** is not supported in offline mode and each zone will water for its full watering length without pausing.
- The controller will only water at your configured **Program Start Times**.

To set your controller to **offline Mode** for manual configuration, please follow the steps below:

1. From the main menu, tap on **Settings**.
2. Tap on **Offline Settings**.
3. Tap on **Disable Wi-Fi**.
4. You will be presented with a warning dialogue. Please make sure you understand the warning before proceeding. If you're sure that you want to go offline, tap **Go Offline**.
5. Now that your controller is in Offline Mode, you can configure it manually by tapping on **Program Start Times**.
6. From this screen, you can manually configure each zone according to your desired

schedule. Simply tap on **Add** to add a program start time and follow the steps below. You can toggle between zones by tapping on **Next/Previous** or you can leave the start time to **APPLY to ALL ZONES**.

Applying the start time to **ALL ZONES** will run through all zones with a single start time.

1. Tap **ADD** in the start times menu.
2. Select the green box upper in left to enter **PROGRAM START TIME (24 hr format)**
3. Tap the **DAYS** to be selected **after** finished with start time entry.
4. Tap **CONFIRM** to save the start time entry.
5. Add a second start time for all zones or single zone if desired.
6. Tap the **HOME** icon (upper right) to allow station run times setup.

**NOTE:** Each zone can have up to four program start times and an additional four start times under the **All Zones** section as shown below.

7. From the home screen, you can manually configure each zone run time. Simply tap on **ZONES** to add a zone run time and follow the steps below. You can toggle between zones by tapping on **each zone number**.

1. Tap **ZONES** in the home menu.
2. Tap the first zone to edit, (**For Example: ZONE 1**).
3. Tap on **RUN TIME** in the center of the screen.
4. Enter **RUN TIME (minutes:seconds format)**, then press **OK** to save entry.
5. Repeat steps **1-4** for station run times.

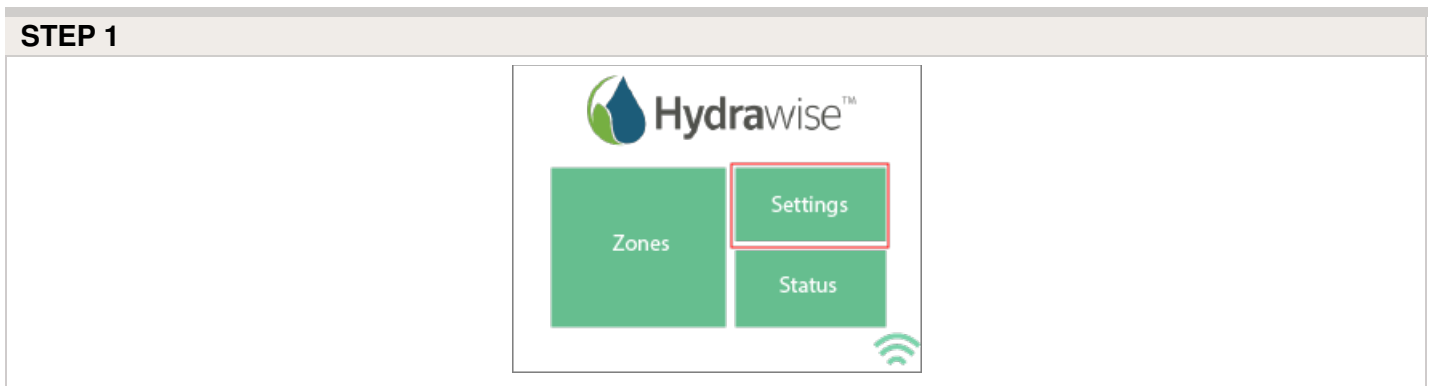

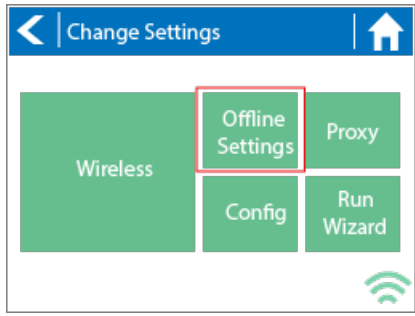

### STEP 3

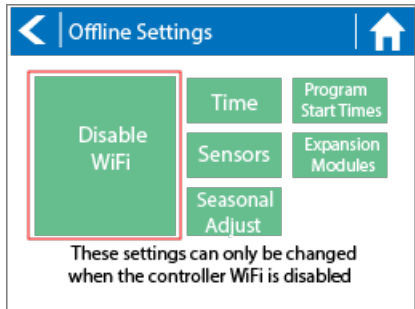

### STEP 4



### STEP 5

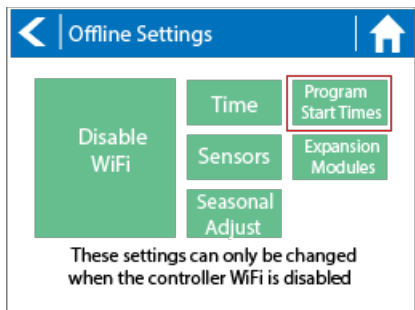

## STEP 6

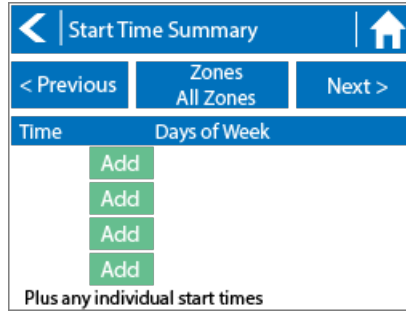

## STEP 7

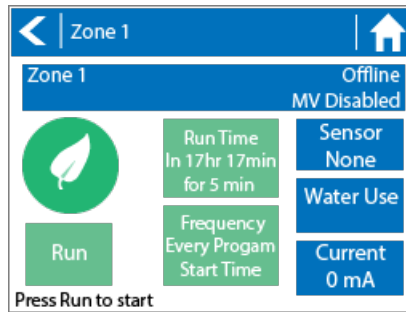

**NOTE:** To get your controller back in online mode, follow the above steps, enable Wi-Fi, reconnect to your SSID (Wi-Fi connection), and let the controller synchronize with your online Hydrowise account.

# Offline Mode - Run the Setup Wizard

Please follow the steps below to run the setup wizard in offline mode. Refer to [Setting Controller to Offline Mode](#) <sup>[39]</sup> or [How to Factory Reset Controller](#) <sup>[40]</sup> before running the wizard.



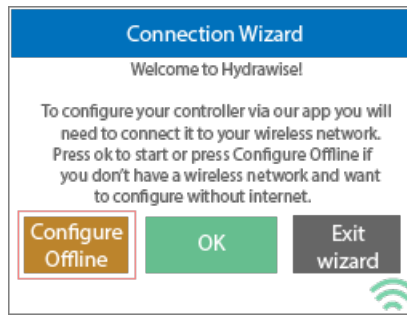

1. From the **Connection Wizard screen**, tap on **Configure Offline**. If you select **OK**, you will proceed to the online setup wizard.
2. Tap **OK** to move on to the next step.
3. Enter in today's date if it hasn't already been set or if it is incorrect.
4. Enter today's time if it hasn't already been set or if it is incorrect.
5. From this screen, tap **OK**.
6. Please assign your **Master Valve** if you're running one as advised on the previous screen. Otherwise, keep **Not Assigned** selected and tap **Confirm**.
7. Tap **OK**.
8. You can now enter (in minutes) the run length you want for your **default zone run time**. Then tap **OK**.
9. Tap **OK** to proceed to the next screen.
10. Next, set how often each zone will run. As advised on the previous screen, you can set individual frequencies for each zone.
11. Tap on **OK** to proceed.
12. From this screen, you can manually configure each zone according to your desired schedule. Simply tap on **Add** to add a program start time and follow the steps below. You can toggle between zones by tapping on **Next/Previous** or you can leave the start time to **APPLY to ALL ZONES**.

**Note: Each zone can have up to four program start times and an additional four start times under the All Zones section as shown below. Applying the start time to ALL ZONES will run through all zones with a single start time.**

1. Tap **ADD** in the start times menu.
2. Select the green box upper in left to enter **PROGRAM START TIME (24 hr format)**
3. Tap the **DAYS** to be selected **after** finished with start time entry.
4. Tap **CONFIRM** to save the start time entry.
5. Add a second start time for all zones or single zone if desired.
6. Tap the **HOME** icon (upper right) to allow station run times setup.

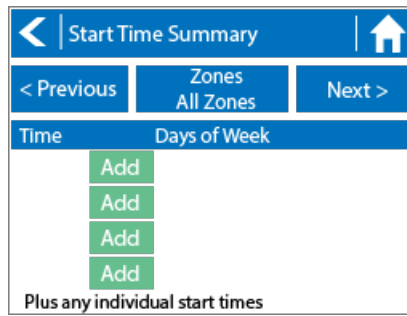

From the home screen, you can manually configure each zone run time. Simply tap on **ZONES** to add a zone run time and follow the steps below. You can toggle between zones by tapping on **each zone number**.

**Note: The default run time and default watering frequency are applied to all zones during the setup wizard. Setting individual run times and frequencies is done by going into each zone afterwards**

1. Tap **ZONES** in the home menu.
2. Tap the first zone to edit, **(For Example: ZONE 1)**.
3. Tap on **RUN TIME** in the center of the screen.
4. Enter **RUN TIME (minutes:seconds format)**, then press **OK** to save entry.
5. Repeat steps **1-4** for station run times.

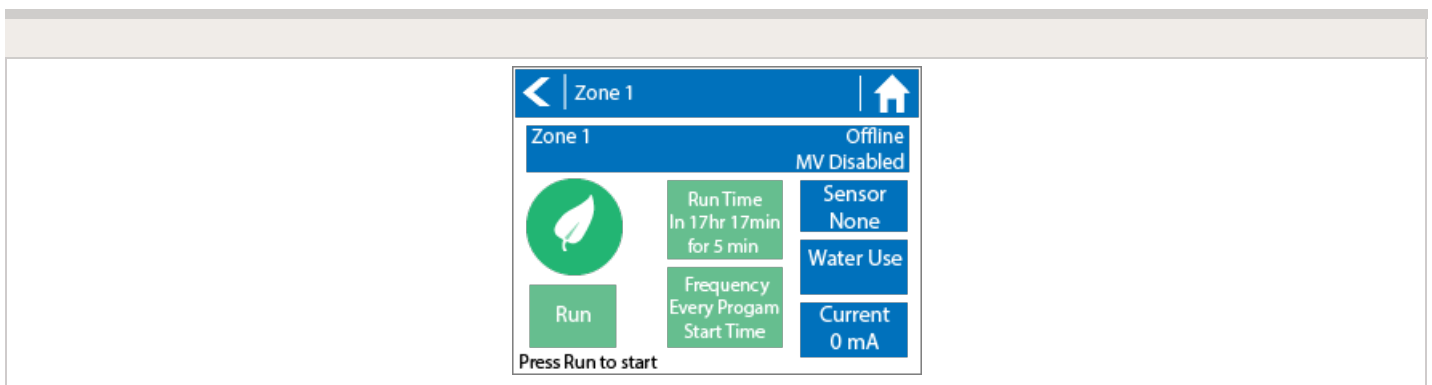

**NOTE:** To get your controller back in online mode, follow the above steps, enable Wi-Fi, reconnect to your SSID (Wi-Fi connection), and let the controller synchronize with your online Hydrowise account.

# Offline Mode - Sensors

Please follow the steps below to add and configure your sensor or flow meter in **Offline Mode**. Please use the following link for [Installation Instructions](#) <sup>[41]</sup>.

1. From the main menu, select **Settings**.
2. Next, select **Offline Settings**.
3. Select **Sensors**.
4. From this screen, you can now navigate between **Sensor 1** and **Sensor 2** by using the **Next** and **Previous** options. Just as you configure your sensors online, you can select the different options to make changes accordingly.

## STEP 1



## STEP 2

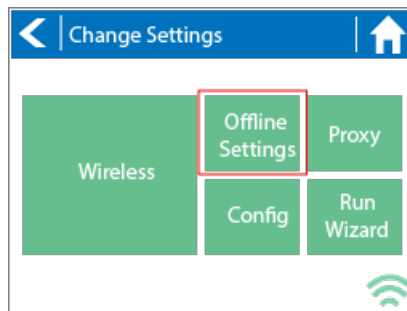

## STEP 3

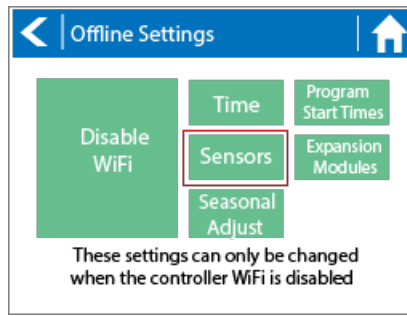

#### STEP 4

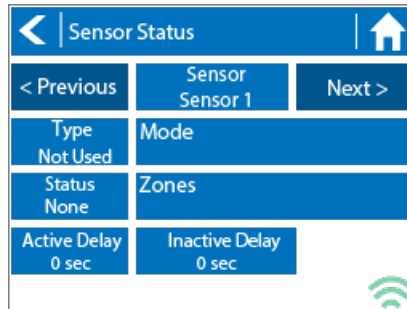

#### Sensor Status Options

Type Options	Not Used, Level (Rain Sensor) or Flow Meter
Mode	Stop when open, Stop when closed, Start when open, or Start when closed.
Status	Open or Closed
Zones	Applies to all zones
Active Delay	Seconds
Inactive Delay	Seconds

## Offline Mode - Seasonal Adjust

Offline water adjustments allow the controller to automatically adjust the amount of watering on a month by month basis if the controller is in an Offline mode (ie. not connected to the internet). Steps below will cover both online and offline instructions on

changing the seasonal adjust for when the controller enters offline mode.

### **Online:** Offline Water Adjustment

1. Select the **three gears** on the upper right.
2. Scroll down to **configuration**.
3. Offline adjustments will be towards the bottom of the page. Sliders can be moved to adjust the offline watering from 0%-300%.

#### STEP 1-2

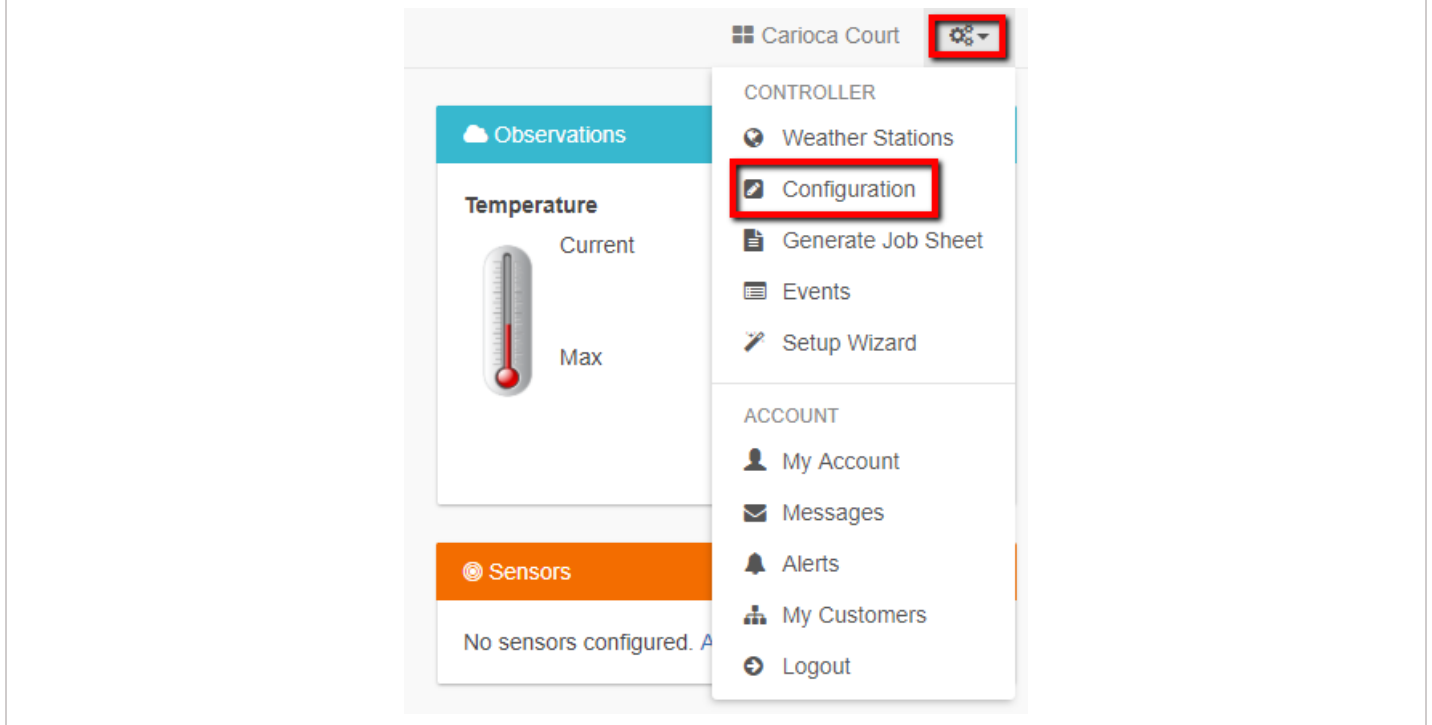

#### STEP 3

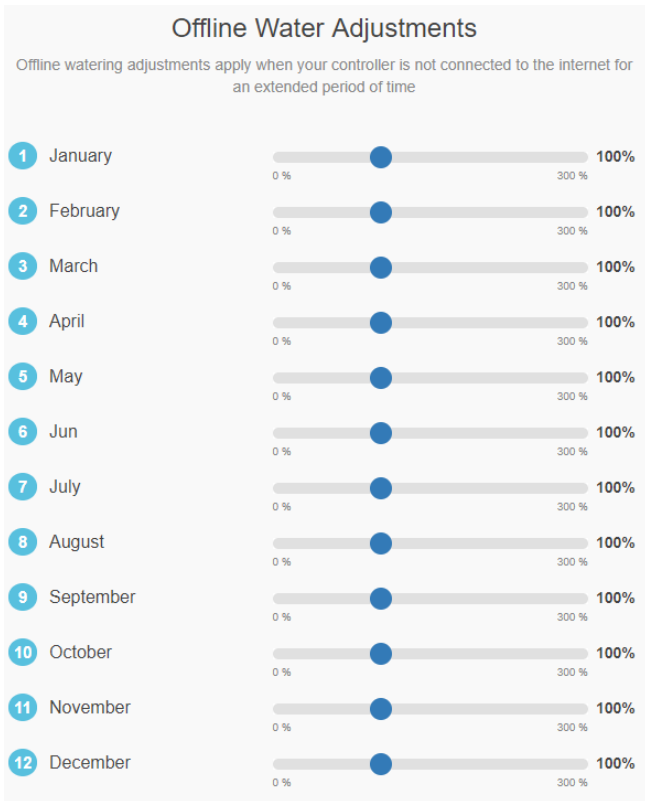

## Offline: Offline Water Adjustment

1. Select settings.
2. Next, select offline settings.
3. Select seasonal adjust.
4. Select a month to adjust.
5. Adjust each month by a percentage then select OK.

### CONTROLLER SCREENSHOTS:

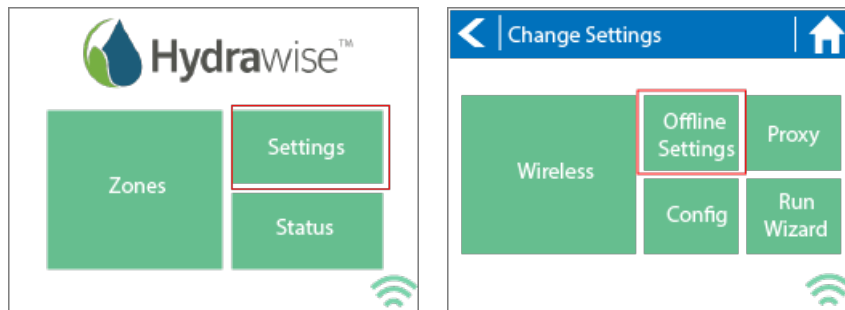

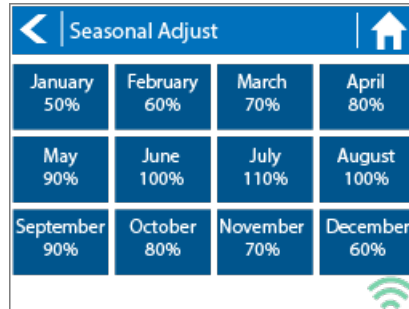
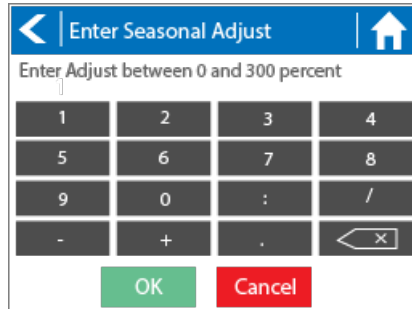
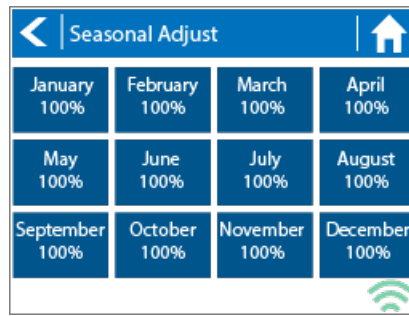
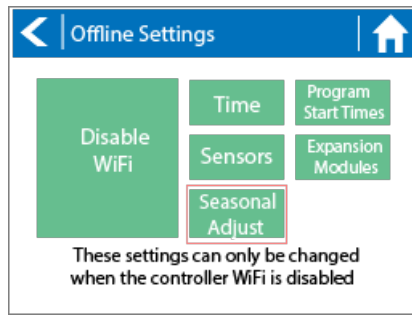

# Account - API Information

Thank you for your interest! The Hydrawise API is coming soon...

Please register your interest with [Anthony.Long@hunterindustries.com](mailto:Anthony.Long@hunterindustries.com) <sup>[42]</sup>

Thank You

Technical Support

---

# Smart Voice Device - Amazon Alexa

In this guide, we will explain how to link your Amazon Alexa account with your Hydrawise account. Once you have linked your Alexa account to your Hydrawise account, you will be able to start, stop, or suspend zones using voice commands to your Alexa device. For example, you can say, "Alexa, ask Hydrawise to start Zone 1."

**NOTE:** Alexa supports only one controller per account. If you have multiple controllers linked to your account, Alexa does not know which controller you are referring to and will not be compatible. We now have Amazon Alexa approved for the following countries USA, Canada, Germany, and India.

## Adding the Hydrawise skill to Alexa

To get started, you will need to make sure you have a Hydrawise account and have your controller configured. If not, please register for a free account [here](#). <sup>[43]</sup> Once you have your Hydrawise account ready, log in to your Alexa account (if you don't have one yet, you can register [here](#) <sup>[44]</sup>). The Alexa account and your Hydrawise account can have a different email address without an issue.

1. Go to the **Skills** section on your Alexa Dashboard.
2. Search for the "**Hydrawise skill**," and select it.

### SKILLS



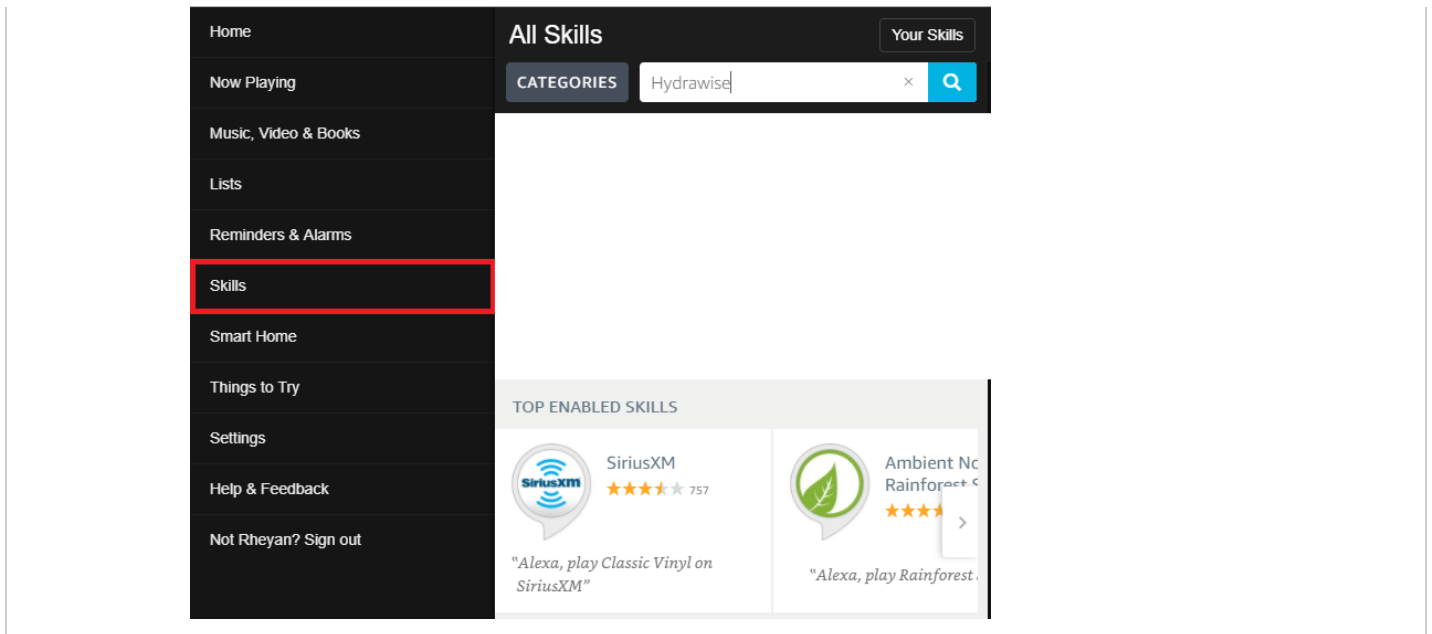

## 1. Click **ENABLE**.

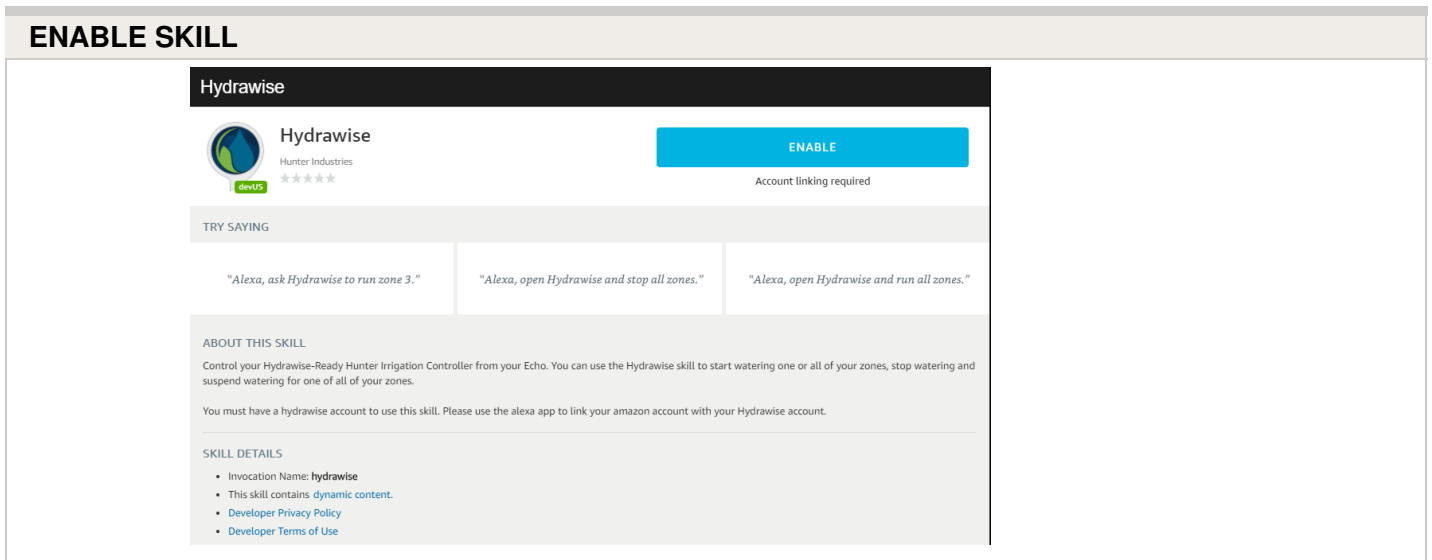

This will open a new window where you can log in to your Hydrawise account.

**IMPORTANT:** Please make sure you have pop-ups enabled for the Hydrawise log-in window. If pop-ups are blocked, you will not be able to log in and continue the linking process.

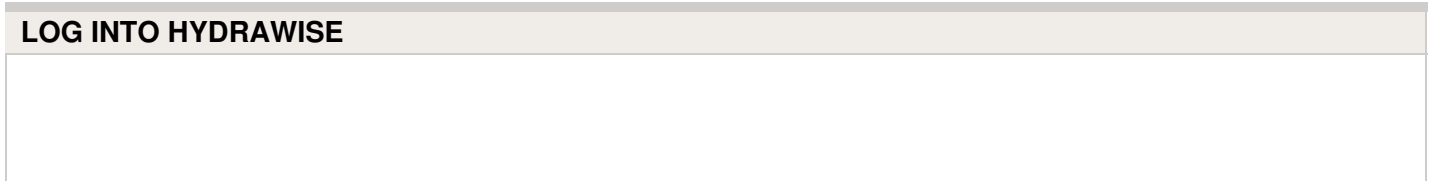

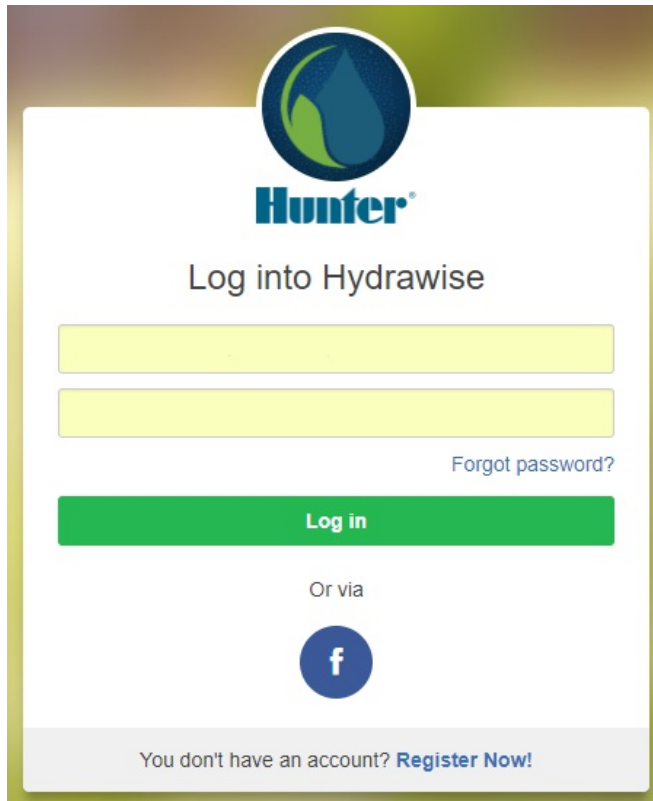

If you are already logged in, you will see the next dialogue box appear.

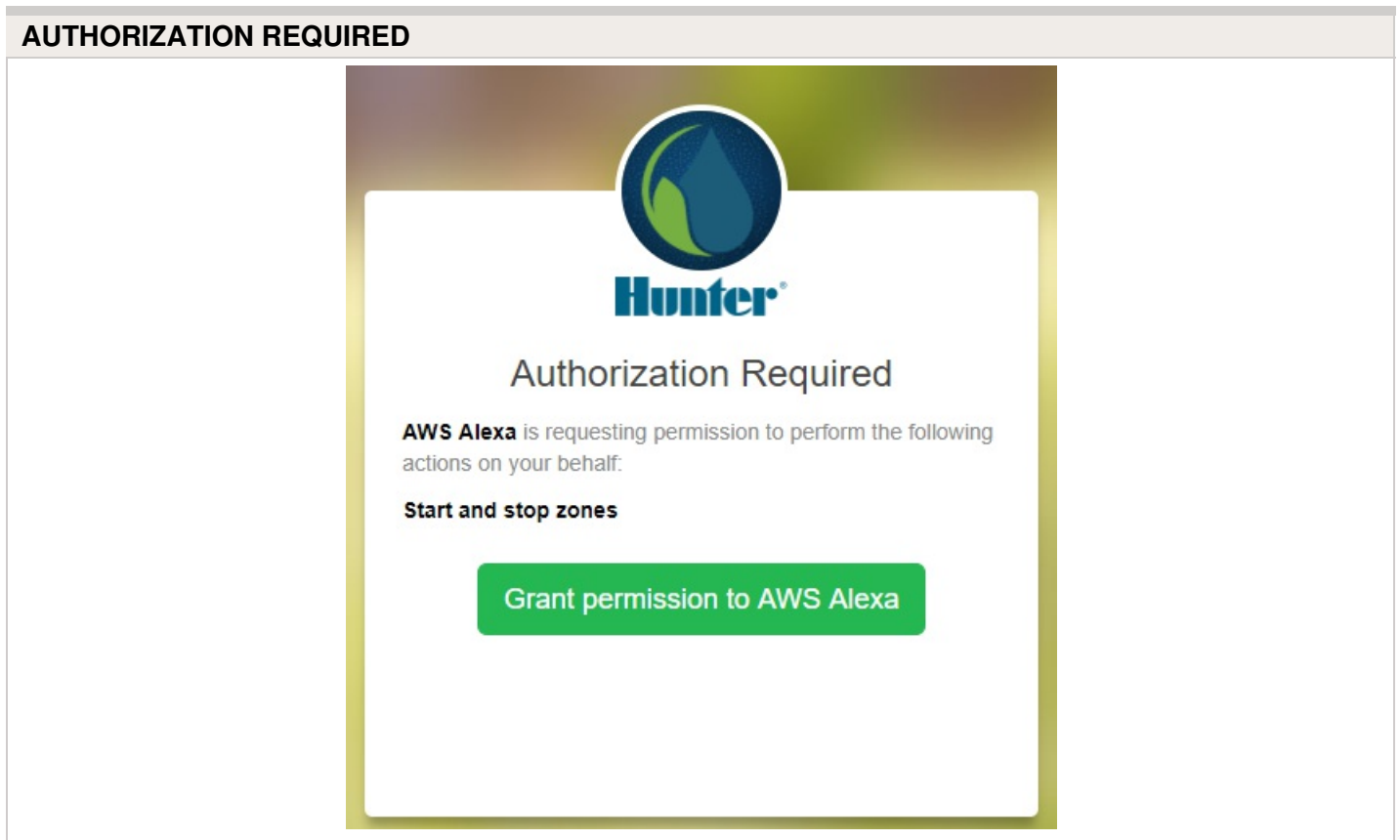

Click **Grant permission to AWS Alexa**.

You will then receive a confirmation that Hydrawise was successfully linked and you can close the window.

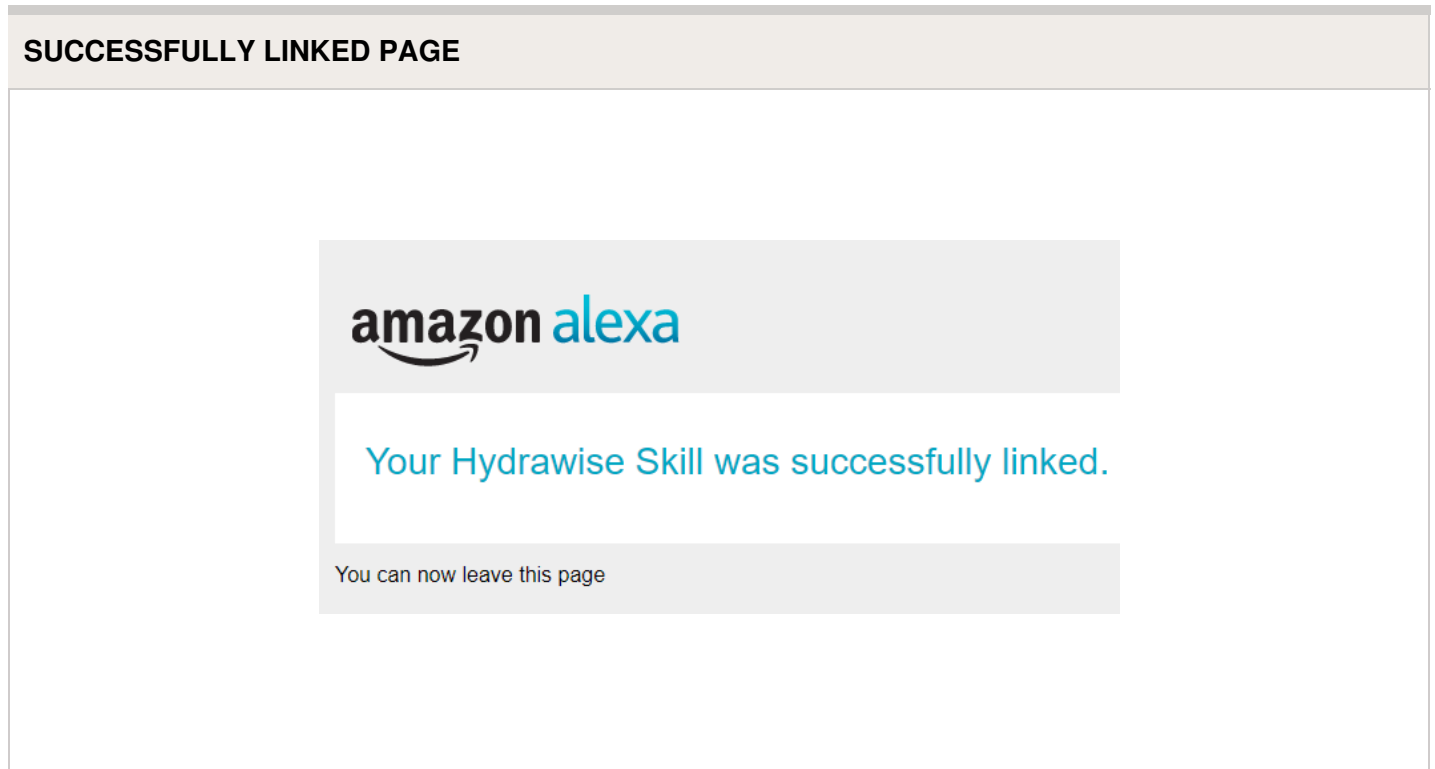

### Using Alexa to control your Hydrawise

Zones can be started or stopped by referencing the zone number (do not use the zone name). For example, if your Zone 1 is called "Front Garden" and you want to start it, you can say, "*Alexa, ask Hydrawise to start Zone 1.*"

Alexa supports the following key phrases:

- Alexa, ask Hydrawise to start/run zone {number}.
  - This command will start a single zone for its default irrigation time.
  - e.g., *Alexa, ask Hydrawise to start Zone 5.*
- Alexa, ask Hydrawise to start/run zone {number} for {x} minutes.
  - This command will start a single zone for a specific time
  - e.g., *Alexa, ask Hydrawise to run Zone 1 for 10 minutes.*
- Alexa, ask Hydrawise to start/run expander {expander number} zone {number}.
  - This command will start a single zone on controllers with expansion modules
  - e.g., *Alexa, ask Hydrawise to start Expander 1, Zone 1.*
- Alexa, ask Hydrawise to start/run all zones.
  - This command will start all zones for their default irrigation time.
- Alexa, ask Hydrawise to stop/finish zone {number}.
  - This command will stop a single zone if it is currently running.
- Alexa, ask Hydrawise to stop/finish expander {expander number} zone {number}.

- This command will stop a single zone on an expansion module.
  - Alexa, ask Hydrowise to suspend zone {number} until {time/date}.
    - This command will suspend all zones for a period of time.
- 

## Home Automation - Control4

Hydrawise is now compatible with Control4 home automation software.

Control4 installers can now download drivers to allow the integration.

From the Control4 app, you can access the following features:

- View icons and zone information
- View proposed watering
- Manually start a zone
- View active (watering) stations

**NOTE:** More details on Control4 integration can be found using this link: [Control4 Details](#)

[45].

---

## HPC - Upgrading Pro-C

Ensure you have a strong Wi-Fi signal. Wi-Fi connectivity can be tested on the HPC panel itself (signal strength is shown when you select a wireless network). If you have any issues connecting the controller to the router, please verify all Wi-Fi specifications [here](#) [1].

## Remove Pro-C Face Panel

1. Remove ribbon cable with power off.
2. Press down on white hinge release button.
3. Remove face panel.

## Install HPC-FP Face Panel

1. Press blue hinges together and attach new HPC panel.
2. Reconnect ribbon cable
3. Close and turn power on

### STEPS



For information on complete setup in the application, please visit our "[How To Guide](#) <sup>[46]</sup>" section.

# HCC - Valve Wiring

1. Route valve wires between control valve location and controller.
2. At valves, attach a common wire to either solenoid wire of all valves. The most commonly used color for the common wire is white. Attach a separate control wire to the remaining wire of each valve. All wire splice connections should be done using waterproof connectors.
3. Open hinged faceplate on the controller to access the terminal strip area.
4. Route valve wires through the conduit and attach conduit to the controller at the large conduit opening on the right side of the bottom of the cabinet. The conduit opening has a triple knockout to accommodate 1", 1¼", or 1½" (25, 32, or 40 mm) conduit. Each

section can be easily removed using a knife.

- Strip ½" (13 mm) of insulation from ends of all wires. Secure valve common wire to **C** (Common) terminal on any of the valve modules or power module. Then attach all individual valve control wires to appropriate station terminals.

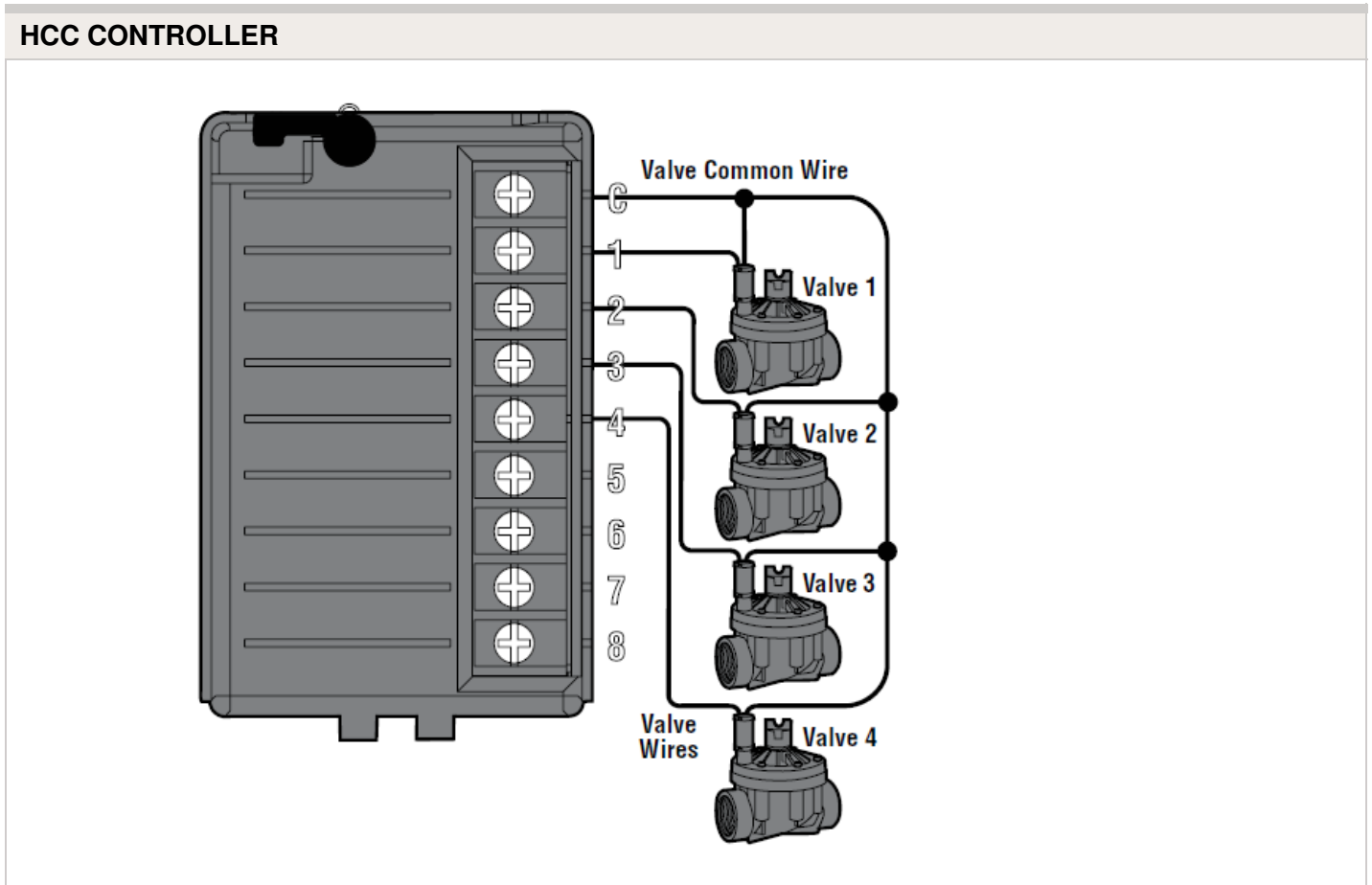

## HCC - AC Wiring

Connecting the controller to primary AC power should be done by a licensed electrician following all local codes. Install in approved conduit and fittings. The controller can operate with either 120VAC or 230VAC power. Supply wires must be 14AWG/ 2 mm<sup>2</sup> or larger.

- Turn AC power "**off**" at the source, and verify that it is off.

2. Disconnect the "**facepack**" ribbon cable.
3. Remove the "**facepack.**"
4. Remove the "**cover**" from the junction box.
5. Strip about **0.5"** (13 mm) of insulation from the end of each AC power wire.
6. Route the wires through the "**conduit opening**" inside the junction box.
7. Connect AC wiring using supplied terminal block (or taped wire nuts where permissible).

2a.

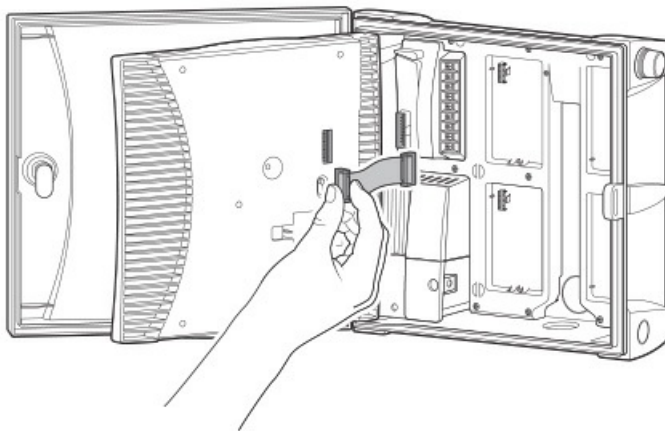

2b.

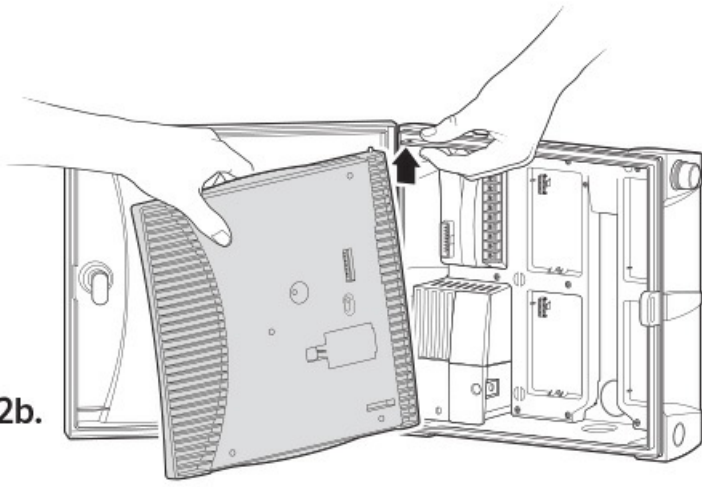

2c.

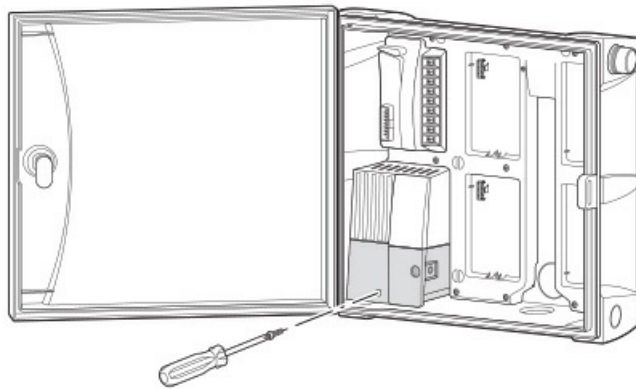

## Wiring Block



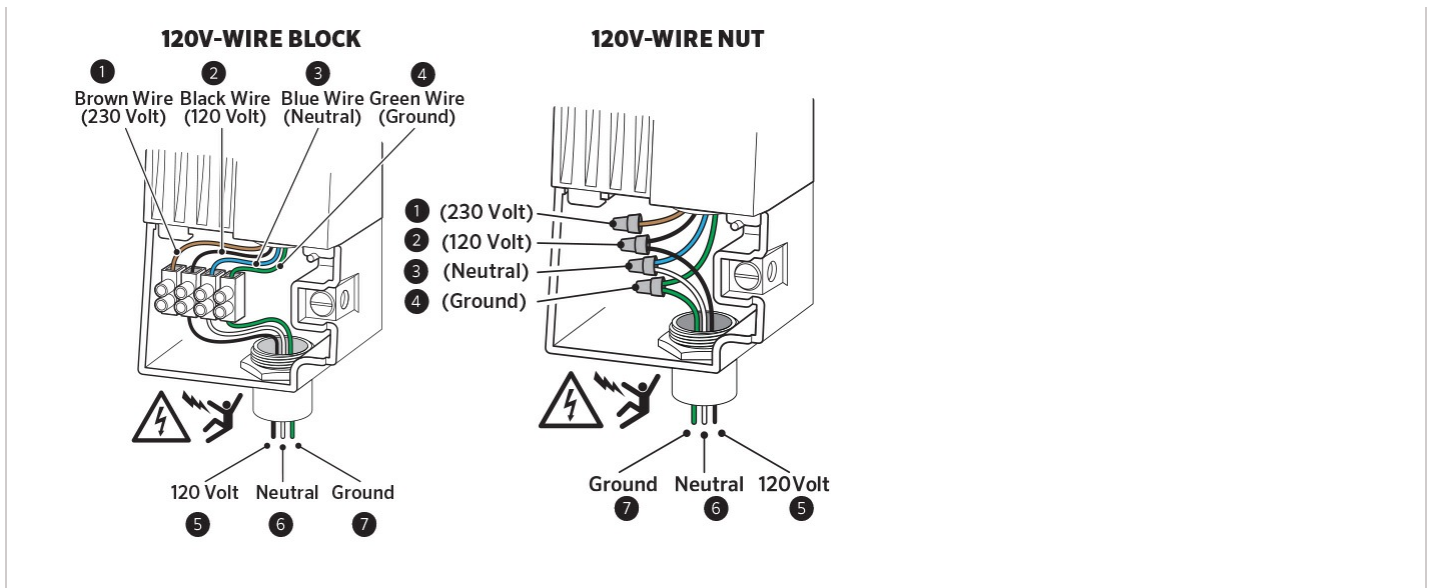

## Wiring Block

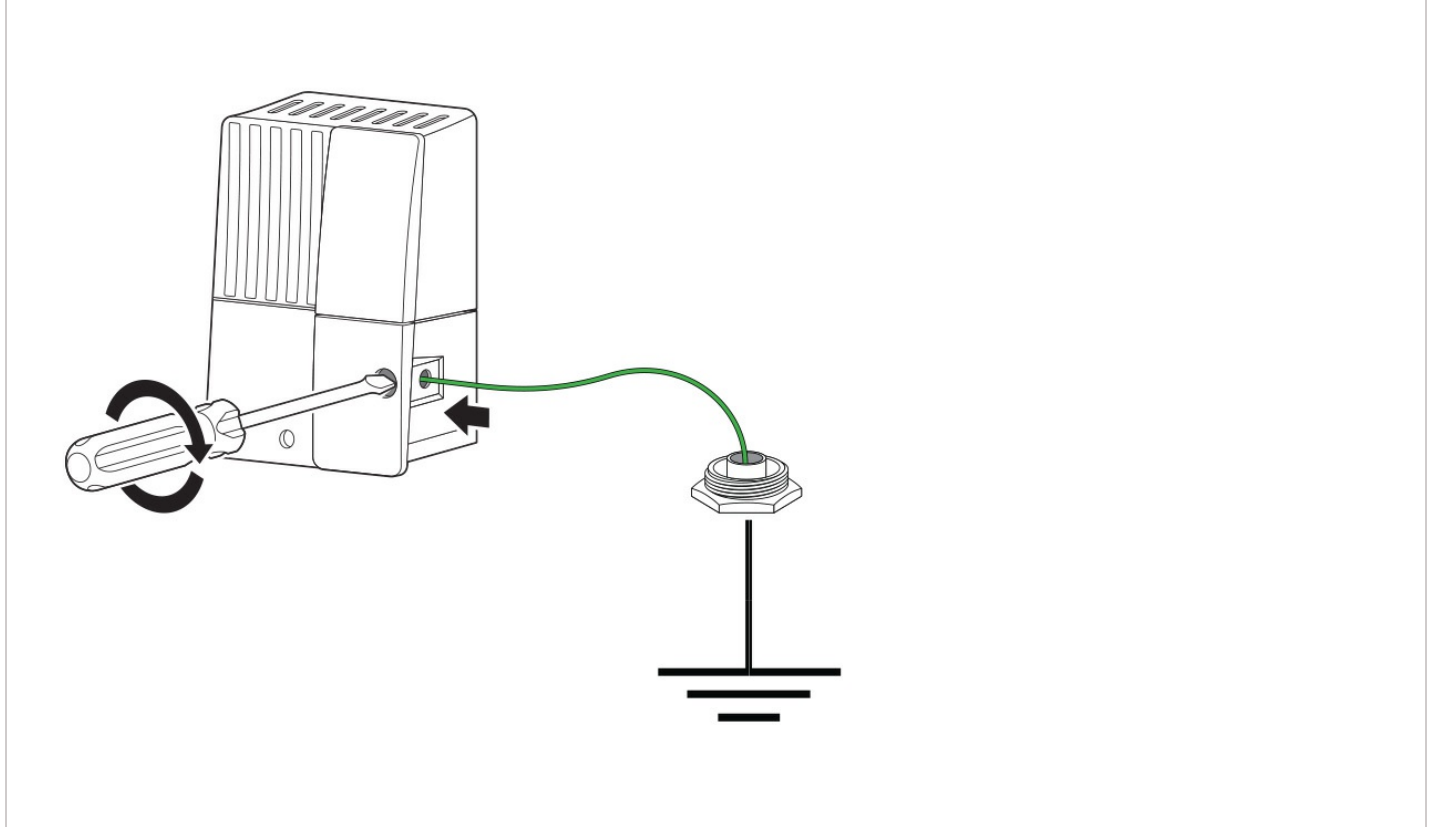

1. Insert copper wire from earth ground hardware, and tighten screw in front.
2. Minimum 10 AWG/5mm<sup>2</sup> wire to earth ground hardware.
3. Add copper-clad steel ground rods and/or plates sufficient to achieve 10Ω or less resistance at a minimum 8'/2.5 m away from controller.

# HPC- WRCLIK and HC Flow Meter

In the event you will need to install a flow meter and a rain sensor on the **HPC** controller, please use the following instructions. The **HPC** controller utilizes a single SEN output so these steps are necessary to make this work. For correct field wiring of the flow meter, please reference the article [here](#). [47]

**NOTE:** The software will only recognize the flow meter for this type of installation. The Wireless Rain Clik will still shut down system after a rain event, but this will not reflect anywhere in the software. The reports will not show ANY data for the rain events.

**IMPORTANT:** You will see alerts for underflow from the flow meter since the system will continue to run even with the common circuit interrupted by the rain event. These alerts will have to be ignored for this type of application. For more details on alerts, please view this article [here](#). [32]

Please reference chart and illustration below for controller wiring details.

Illustration	Terminals	Wires
Figure 1.	AC 1/ AC 2	WRCLIK Yellow
Figure 2.	COMMON	WRCLIK White
Figure 3.	Valve Common	WRCLIK Blue
Figure 4.	Flow meter - Blue/White	METER Blue/White

Right Click to View Larger image

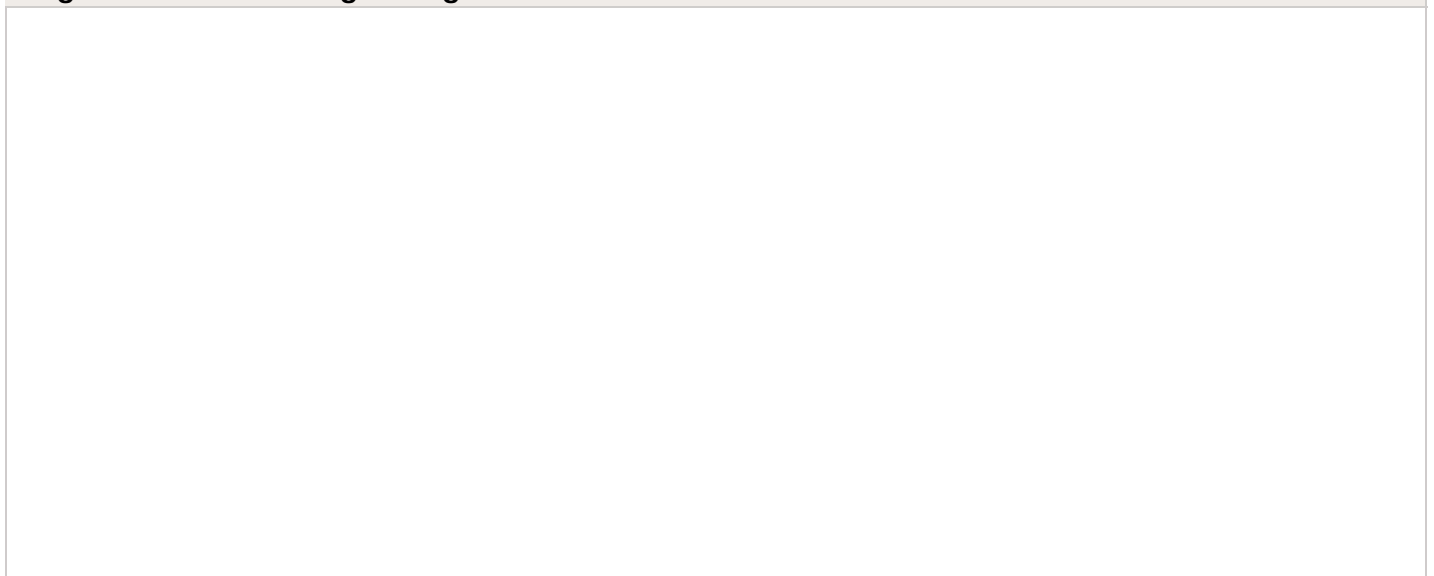

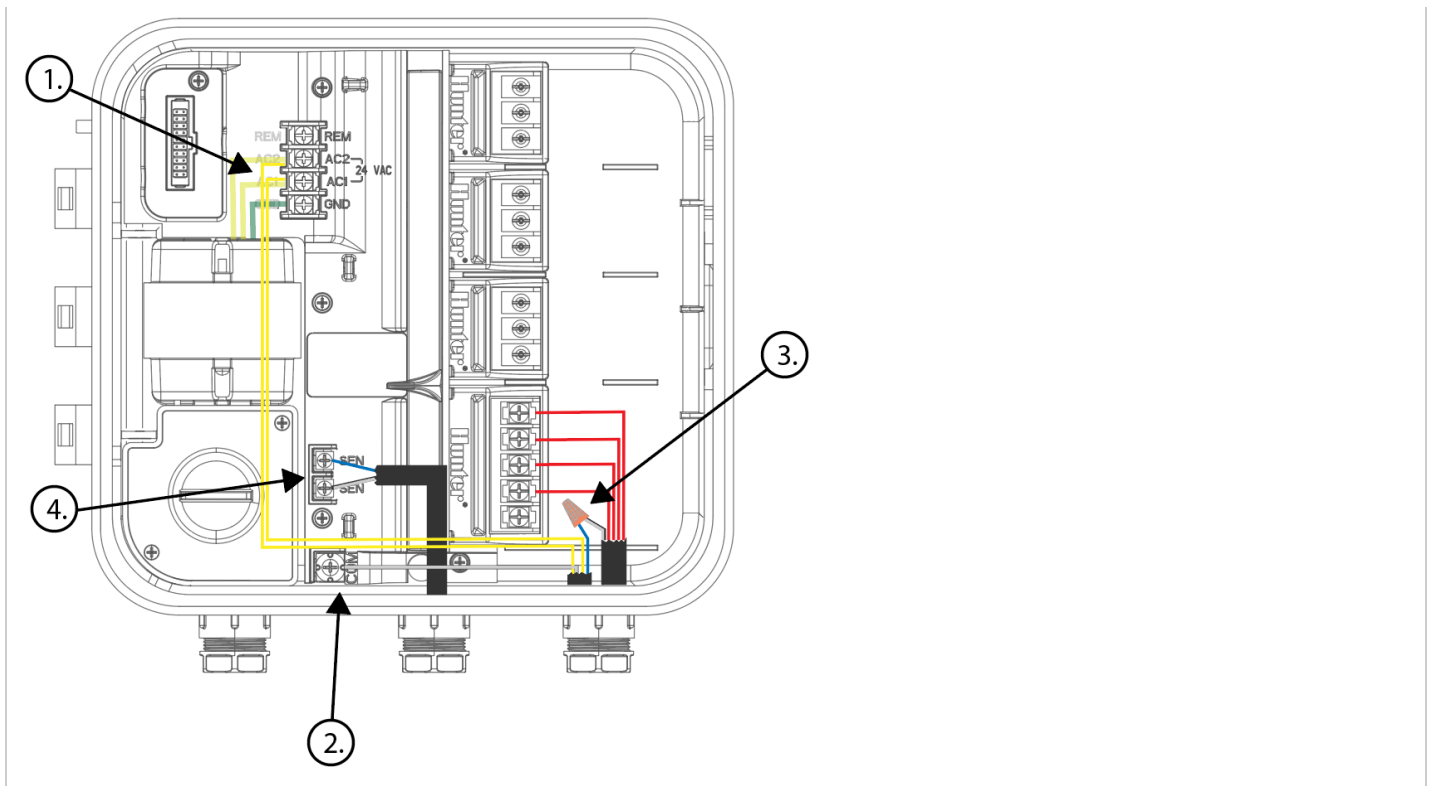

# Flow Meter - Install Chart

The chart below will include all the necessary key points of the install to avoid any false alerts or readings.

Installation Steps	Description
Flow Meter Body	Flow meters are designed to be installed <b>horizontally only</b> , not vertically. Analog dial for manual readings shown in US gallons. Units can be changed in App to gallons or liters.
Adapter	Brass unions included to fit your irrigation system.

Entry Location	Install between the <b>master valve</b> and zone valves. Meter should be installed 10 times pipe diameter before and 5 times after with straight pipe, no fittings.
Cable used (Shielded Only)	18 gauge - 1000 foot max Length. <b>Shielded wire must be used.</b> Cable should consist of two dedicated wires and must not be in the same conduit, cable bundle or trench as the solenoid wires. DO NOT share common wire. Avoiding electrical interference, see below:
Flow meter body	Arrow indicates direction of flow.
Wire Connection	Blue/White wire only, <b>red not used.</b> See <a href="#">sensor configuration</a> [48] for more info based on model controller.
Log in to your account	Enter your <a href="#">login</a> [10] information.
Create your flow sensor	App will show options for all HC meters.
Creating Alerts	See link <a href="#">here</a> [32]

## Avoid Electrical Interference

- Always use Shielded Cable, between the controller and the HC Flow Meter.
- At the controller end using the shield (foil wrap) and the bare wire connect them to the Controller GND terminal, not required for HC controllers.
- Do not connect the other end of the Shield or the bare wire to the Earth or a grounding stake
- Use Waterproof wire connectors at the flow meter, such as [3M 316IR](#) [49] or [3M DBY](#) [50]
- Shielded cable is commonly available, here are some manufacturers. [Paige](#) [51] & [Regency](#) [52]

# Flow Meter - Quick Start Guide

Please click on the link below to download the flow meter connection guide.

[Connecting Your Hydrowise Flow Meter](#) [53]

# Flow Meter - Specifications

## HC FLOW METER SPECIFICATIONS



	HC-075-FLOW (¾")	HC-100-FLOW (1")	HC-150-FLOW (1½")	HC-200-FLOW (2")
<b>Inlet/outlet connection size</b>	¾" NPT body, male thread with 1" NPT male adapter	1" NPT body, male thread with 1.5" NPT male adapter	1½" NPT body, male thread with 2" NPT male adapter	2" NPT body, male thread with 3" NPT male adapter
<b>Meter internal diameter</b>	¾"	1"	1.5"	2"
<b>Minimum flow (GPM)</b>	0.22	0.3	0.88	1.98
<b>Maximum recommended flow (GPM)</b>	15	30	66	105
<b>Maximum flow rate (GPM)</b>	21	34	88	132
<b>Dial reading (US gal)</b>	1 pulse per 0.1 U.S. gal	1 pulse per 1 U.S. gal	1 pulse per 1 U.S. gal	1 pulse per 1 U.S. gal
<b>Maximum working pressure (PSI)</b>	230	230	230	230

---

# Flow Meter - Test

If your flow meter is working but is not recording data in your **Dashboard** or events, follow the steps here:

1. If you can access the wires at the flow-meter end, strip the two wires back (if you're using quick disconnects, you can use a paper clip or wire to make contact) and touch them together. Do this 10 times, as each contact will record a pulse.

2. Access your app and see if flow data was registered.

- If yes, your wiring and system are set up correctly. Reconnect to the flow meter and run a large flow (lots of sprinklers) zone. Did you get a flow on your app? If yes, all is OK. If no, contact [support@hydrawise.com](mailto:support@hydrawise.com) <sup>[54]</sup>.
- If no, go back to the controller and use another piece of wire to connect one end to either sensor 1 or sensor 2 (the port the flow meter is normally connected to). Then tap the other end against the sensor common (in the blue section). Do this 10 times.

3. Go to the app and see if it registered flow data.

- If yes, there is a problem with the wire running to the flow meter.
- If no, contact [support@hydrawise.com](mailto:support@hydrawise.com) <sup>[54]</sup>.

4. To test the sensor inputs on the controller, you can use the same method with a paper clip or wire to make contact between sensor 1/sensor 2 and the sensor common. Do this 10 times and then check for flow data in your Dashboard.

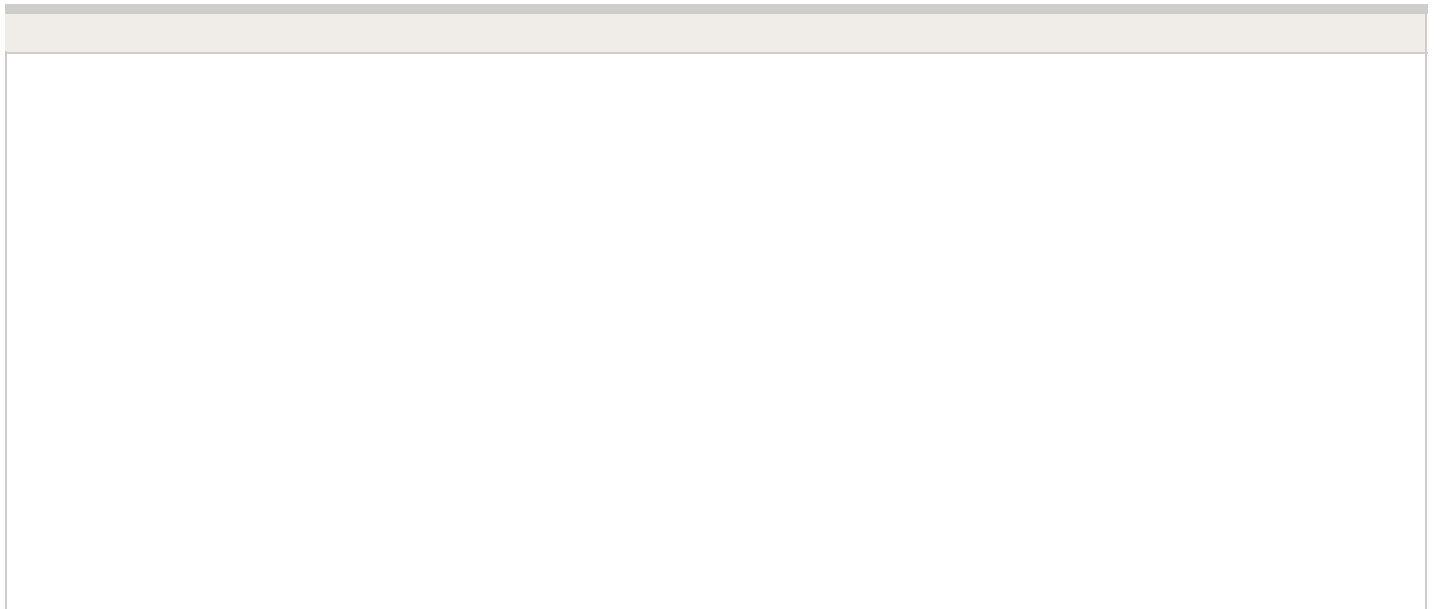

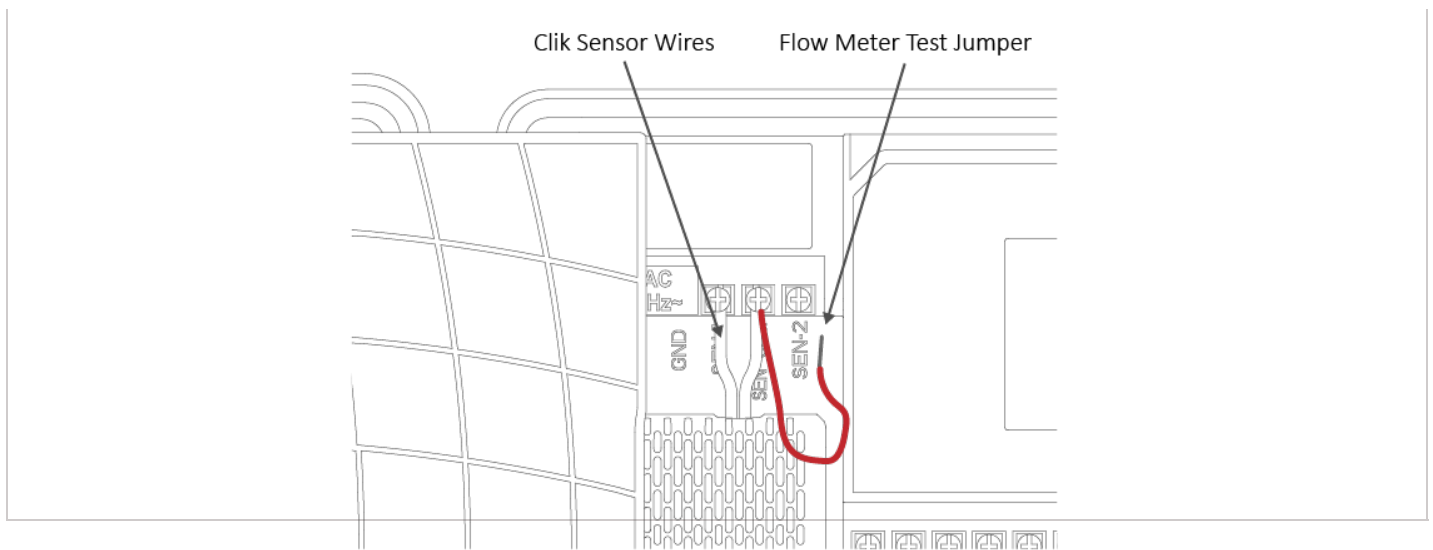

**IMPORTANT:** Our controller is not polarity sensitive. There is no risk of electric shock when performing these tests. However, if you feel uncomfortable, please contact a qualified technician or irrigation specialist for further assistance.

**NOTE:** If it works at the controller end but not the flow-meter end, there is a wiring fault.

If it doesn't work at the controller end, contact [support@hydrawise.com](mailto:support@hydrawise.com) [54].

If it works at both ends, but still does not register flow on the app, contact [support@hydrawise.com](mailto:support@hydrawise.com) [54].

---

# Flow Meter - Custom Flow Sensor Configuration

To add a custom flow sensor, go to [Sensors](#) [55] from your web browser or smartphone application.

## 1. Click **Add Custom Sensor Type**

### STEP 1

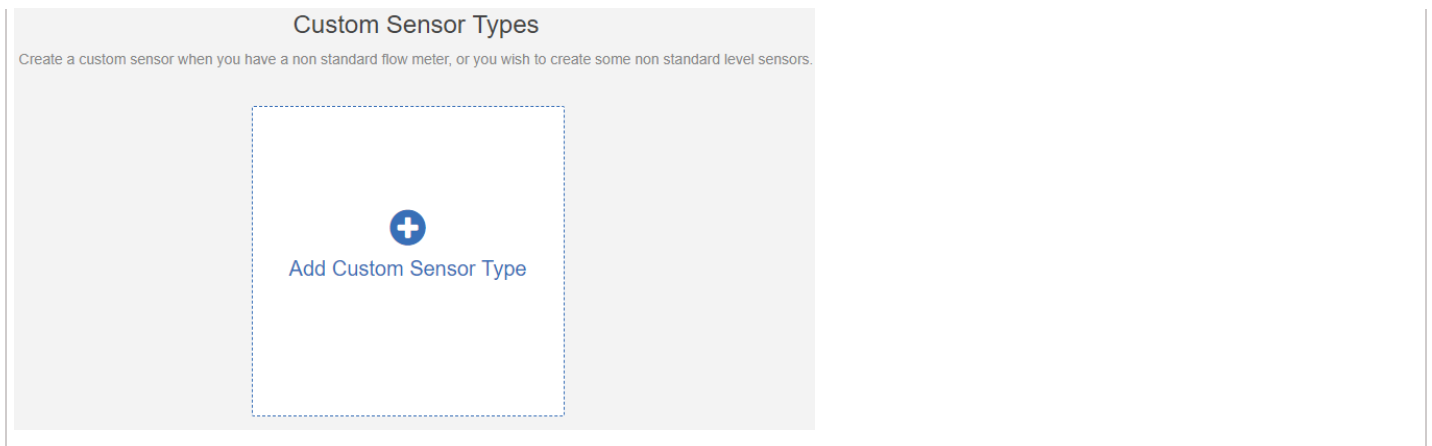

A dialogue box will appear for you to enter your custom flow meter details. Make sure you enter the calibration details for your custom pulse-based flow meter. Please refer to the manufacturer specifications to find out the calibration. Otherwise, you will not get accurate readings to display on your flow data.

**NOTE:** For our system to detect the correct flow data and reflect it on your **Dashboard** reports, any third-party flow meter used must be a true pulse flow meter or have a reed switch. We aim for a minimum of 10 pulses per min and a maximum of 120 pulses per min. That means if the flow rate was 10 gal per min, 1 pulse per gallon needs to be set.

When using a third-party flow meter, please ensure it meets the specs above and is calibrated correctly. Otherwise, data will not reflect accurately in reports. Also, note that the



wiring is not polarity sensitive. As long as you have one wire in a **Sensor Port** and a **Sensor Common**, the device will work correctly. For flow meters that use three wires and meet the specs above, configure the wiring until you find the two correct wires to use.

## Flow Meter - Winterization

We recommend that a qualified licensed contractor perform this type of winterization method. The blowout method utilizes an air compressor with a cubic foot per minute (CFM) rating of 80-100 for any mainline of 2" or less. The compressor is attached to the mainline via a quick coupler, hose bib, or other type connection, which is located beyond the backflow device. Compressed air should not be blown through any backflow or flow meter device. For additional winterization procedures, we highly recommend contacting the local dealer for the most common local practices. In the event you need to blow upstream from where the flow meter is located, we recommend bypassing the meter by temporarily installing a SCH 80 or galvanized nipple. See the size chart below:

Model	Description	Male-Thread NPT	Nipple Length
HC-075-FLOW	¾" NPT body, male thread with 1" NPT male adapter	1" NPT	5"
HC-100-FLOW	1" NPT body, male thread with 1.5" NPT male adapter	1 ¼"NPT	5"
HC-150-FLOW	1½" NPT body, male thread with 2" NPT male adapter	2"NPT	11 ¾"
HC-200-FLOW	2" NPT body, male thread with 3" NPT male adapter	2 ½"BSP	11 ¾"

Find a Hunter Distributor closest to you using our interactive lookup - [Get Hunter](#) <sup>[56]</sup>

For step-by-step instructions on installing the nipple to bypass the flow sensor, **CLICK** on this link: [Flow Meter Winterization Bypass](#) <sup>[57]</sup>

---

# Sensors - Configuration

Hydrawise supports two types of sensors:

1. Flow sensors that measure water usage for an irrigation zone (or zones).
2. Rain sensors, wind sensors, and moisture sensors (sometimes called on/off sensors) that allow you to suspend watering cycles for a zone (or zones).

## Flow Meters

Flow meters measure the amount of water going onto each zone. This is really useful for understanding water usage and monitoring issues such as broken pipes.

Hydrawise reporting allows you to see how much water is used for each zone and how much water is used across your system.

With a flow meter, you can also create alerts for flow issues, which will keep you up to date on what's happening (particularly important for unattended homes). See [Creating Alerts](#) <sup>[58]</sup> for more information.

Flow Meters	
US Hunter HC Flow Meters	3/4 inch NPT Flow Meter
US Hunter HC Flow Meters	1, 1/5, or 2 inch NPT Flow Meter
Metric Hunter HC Flow Meters	20mm BSP Flow Meter
Metric Hunter HC Flow Meters	25, 40, or 50mm BSP Flow Meter
Discontinued Sensors	Flow Meter with 3/4 inch coupling

## Rain/Moisture Sensors

Hydrawise also supports standard open/closed contact rain sensors and soil moisture sensors. In fact, you can use any generic type of sensor that has an open/close contact.

These sensors use two wires and are usually labeled as normally open (sometimes called NO) or normally closed (sometimes called NC).

A rain or moisture sensor is usually used to stop irrigation. However, you can also create your own custom sensor types to start irrigation or for other advanced applications. See [Creating a Custom Sensor](#) <sup>[59]</sup> for more information.

HUNTER CLIK	
Rain Sensor (Normally Open)	A standard rain sensor (use this if you have wired the rain sensor's normally open wire to the controller)
Rain Sensor (Normally Closed)	A standard rain sensor (use this if you have wired the rain sensor's normally closed wire to the controller)
Soil Moisture Sensor (Normally Open)	A standard soil moisture sensor (use this if you have wired the soil moisture sensor's normally open wire to the controller)
Soil Moisture Sensor (Normally Closed)	A standard soil moisture sensor (use this if you have wired the soil moisture sensor's normally closed wire to the controller)

## Wiring

Flow meters are supplied with [detailed installation instructions](#) <sup>[41]</sup>.

The flow meter wires need to be cabled back to the controller and connected to the **Sensor** inputs on the controller. See chart below for wiring standard Hydrawise flow meters (Sizes include 3/4", 1", 1.5", 2")

FLOW METER WIRE	SCREW TERMINAL	CONTROLLER
BLUE	SEN 1, 2	HC
BLUE	SEN 1, 2	PRO-HC
BLUE	SEN	HPC-FP
WHITE	COM	HC
WHITE	SEN COM	PRO-HC

WHITE	SEN	HPC-FP
RED	Not Used, Cap off	N/A

SENSOR WIRE	SCREW TERMINAL	CONTROLLER
Wire 1	SEN 1, 2	HC
Wire 1	SEN 1, 2	PRO-HC
Wire 1	SEN	HPC-FP
Wire 2	COM	HC
Wire 2	SEN COM	PRO-HC
Wire 2	SEN	HPC-FP

WIRELESS RAIN CLIK	SCREW TERMINAL	CONTROLLER
Yellow/Yellow	24V/24V	HC
Yellow/Yellow	AC1/AC2	PRO-HC
Yellow/Yellow	AC1/AC2	HPC-FP
Blue	SEN 1, 2	HC
Blue	SEN 1, 2	PRO-HC
Blue	SEN	HPC-FP
White	COM	HC
White	SEN COM	PRO-HC
White	SEN	HPC-FP
Orange	Not Used for Hunter Controllers	Open Circuit Controllers Only

Once you've wired your rain, moisture sensor or flow meter, configure it in your Hydrowise account as shown below.

## Sensor Configuration

There are two steps to getting your sensor to work for each of your zones:

1. Create a new sensor in your Hydrowise account under [Sensors](#) <sup>[55]</sup>. Choose the sensor name, type of sensor, and the controller input. You also have the option to [create a custom sensor](#) <sup>[59]</sup>.

2. Once you've created your sensor, **assign the zones** that will use the sensor in the sensor table.

### STEP 1

Add Sensor ×

**Sensor details** ▶ **Set zones**

**Sensor Name**

Assign a descriptive name for this sensor

Wireless Rain Clik

**Type of Sensor**

Choose the type of sensor you have installed. You can also create a custom sensor type if you have something non standard.

Rain Sensor (normally closed wire) ▼

Create New Sensor Type...

**Controller Input**

Choose the input on the controller that this sensor is wired to

SENSOR 1 ▼

Cancel < Prev **Next >** **OK**

### STEP 2

Add Sensor ×

**Sensor details** ▶ **Set zones**

**Select Zones**

Select the zones which will use this sensor

**Available zones**

- Carioca Court
- Front Grass
- Street Drip
- Front Drip
- Back Grass
- Back Drip
- Diamond Street Controller

**Selected zones**

Cancel < Prev **Next >** **OK**

**Create a Custom Sensor** You can also create custom sensors in your Hydrowise account under **Sensors**. Some examples of custom sensor types are:

- A flow meter of a different size to the standard Hydrowise flow meters.
- A sensor to conform to restrictions that specify no watering for a minimum period of time after rain is detected.
- A sensor to start irrigation if motion is detected (Enthusiast Plan only)

To add a custom sensor type, go to **Sensors** and click on **Add Custom Sensor Type**. Give the sensor a name and choose its type as outlined below. **Flow Meter** Liters per pulse: The number of liters of water expected to pass through the flow sensor per flow meter pulse (you can get this information from your flow meter's specifications) **Normally Open Sensor/Normally Closed Sensor** Sensor Action: Whether the sensor should cause a zone to start or stop. **Start a Zone** If the zone should start, choose the minimum number of seconds before the sensor can cause the same zone to start again. **Stop a Zone** If the zone should stop, choose the number of seconds to delay before stopping the zone, and how long the zone should be disabled. For example, some watering restrictions require that if rain is detected, sprinklers should not run for at least two days.

### Custom Setup Example

Add Custom Sensor Type ×

**Sensor Type Name**  
Assign a descriptive name for this sensor definition

**Type of Sensor**



**Sensor Action**

---

# Sensors - Clik Sensor Status

Please take note of the sensor states below once you've successfully set up your sensor through the Hydrowise application.

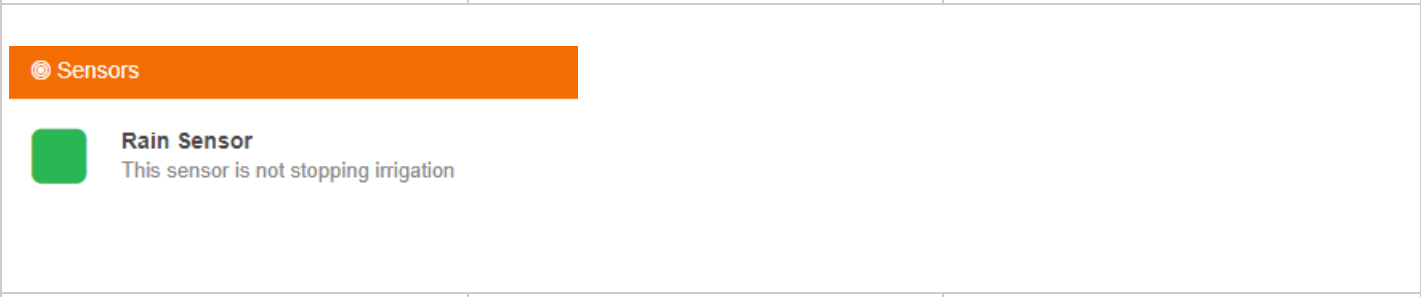
## Normally Closed (Default Setup) All Hunter CLIK Sensors

Sensor Status		
<b>GREEN</b>	Dry - Not Stopping Irrigation	Water
 <p>The screenshot shows a mobile application interface. At the top, there is an orange bar with a white circle containing a sensor icon and the text "Sensors". Below this, there is a green square icon followed by the text "Rain Sensor" and "This sensor is not stopping irrigation".</p>		
<b>RED</b>	Wet - Stopping Irrigation	No Water
 <p>The screenshot shows a mobile application interface. At the top, there is an orange bar with a white circle containing a sensor icon and the text "Sensors". Below this, there is a red square icon followed by the text "Rain Sensor" and "This sensor is stopping irrigation".</p>		

**Note:** A good example would be a simple switch where closed would represent **ON** position and open would mean the **OFF** position.

For more information on configuring sensors, check our guide [here](#) [60].

---

# Sensors - Installing Personal Weather Station

## Installing your own weather station

Installing your own weather station is not a requirement for using a Hydrowise controller. The vast majority of customers use one of the 25,000 weather stations already available to each Hydrowise controller. You may have already realized that the Hydrowise irrigation system is driven in part by temperature, rainfall measurements, and predictions sourced from a weather network called Weather Underground.

Worldwide, the network has tens of thousands of privately owned and operated weather stations that contribute data to be shared by all. During setup of your Hydrowise controller, you would normally select three or more nearby stations for temperature and rainfall calculations and decisions. Since Weather Underground is an open network, you have the option of setting up your own weather station to report and share weather data with others. It is relatively easy and inexpensive to do so.

There are a few possible reasons to set up your own station:

- You don't have any nearby stations to select from.
- You want your observations to be as accurate as possible.
- You have other uses for the local climate information.

There is a wide range of weather stations available on the market suitable for uploading weather data to Weather Underground. The following link provides the most common [Stations](#). <sup>[61]</sup>

The different brands offer different measurements, accuracy, and build quality. Consequently, they vary in price from about \$100 (U.S. dollars) to \$1,000. They generally measure the following parameters:

- Indoor temperature and humidity
- Outdoor temperature and humidity
- Rainfall
- Wind speed
- Wind direction
- Atmospheric pressure

You can refer to this link for the exact steps to register your personal weather station. [Weather Underground](#) <sup>[62]</sup>

Once Weather Underground has approved and are broadcasting the PWS, please provide



us with the PWS ID. We can upgrade you to the free PWS plan so you have access to your own weather station. [Contact Us](#) [63]

---

# Master Valve - Configuration

A master valve is an automatic valve installed at the point where the irrigation system connects to the water supply. (Sometimes this circuit is called a “pump start circuit.” Both types work in a similar fashion, and can be used as a pump and/or a master valve.) The controller turns the master valve on and off.

## How does it work?

Zone valves are the individual valves that operate a group of sprinklers or drip emitters. A Hydrowise controller supports 6 or 12 zone valves, depending on the model. Typically, one zone valve is turned on at a time and controls the irrigation in a specific area of your landscape. Whenever one of the irrigation zone valves is told to open by the controller, the controller also signals the master valve to open. This means that the master valve acts somewhat like a backup valve or a fail-safe valve. The purpose of the master valve is to shut off the water to the irrigation system when no zone valves are operating. The image below shows a master valve operating connected to Zone 12 on a Hydrowise controller.

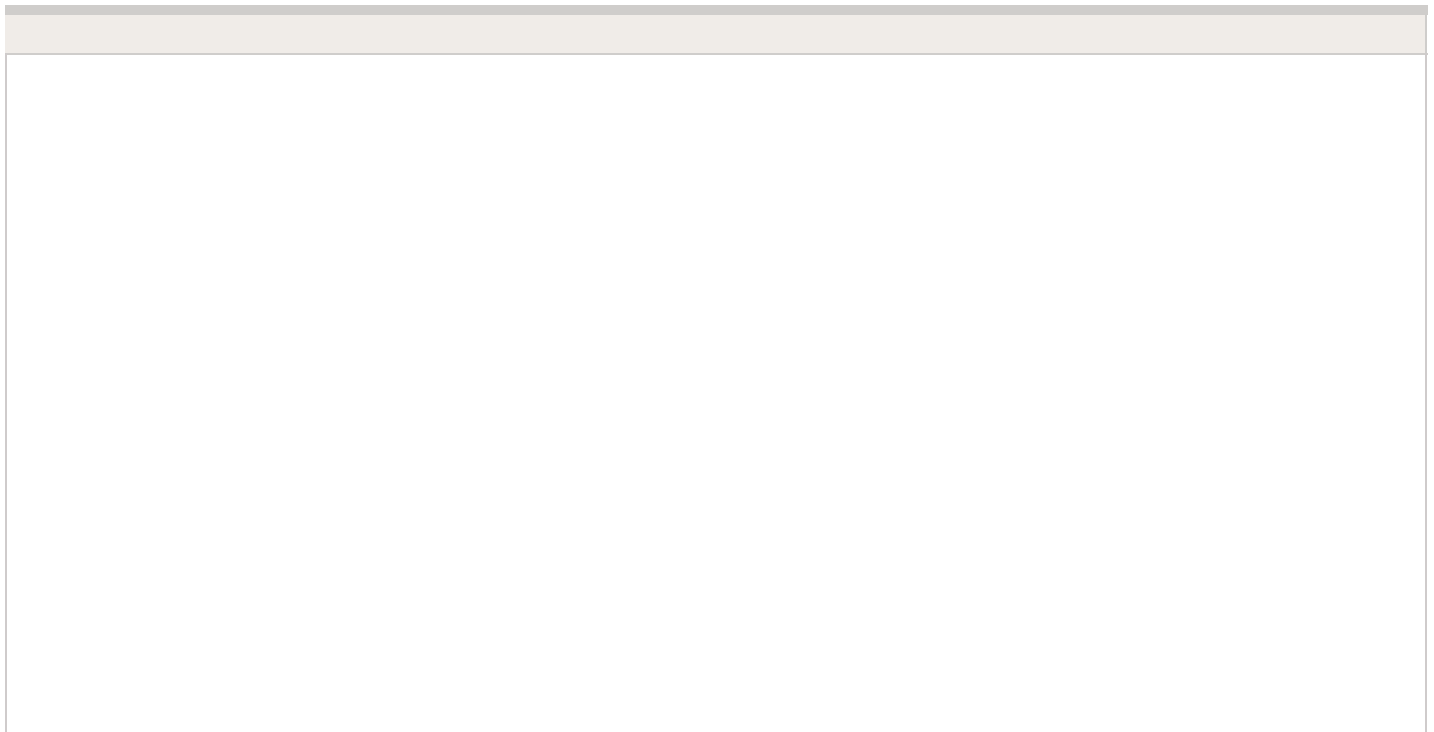

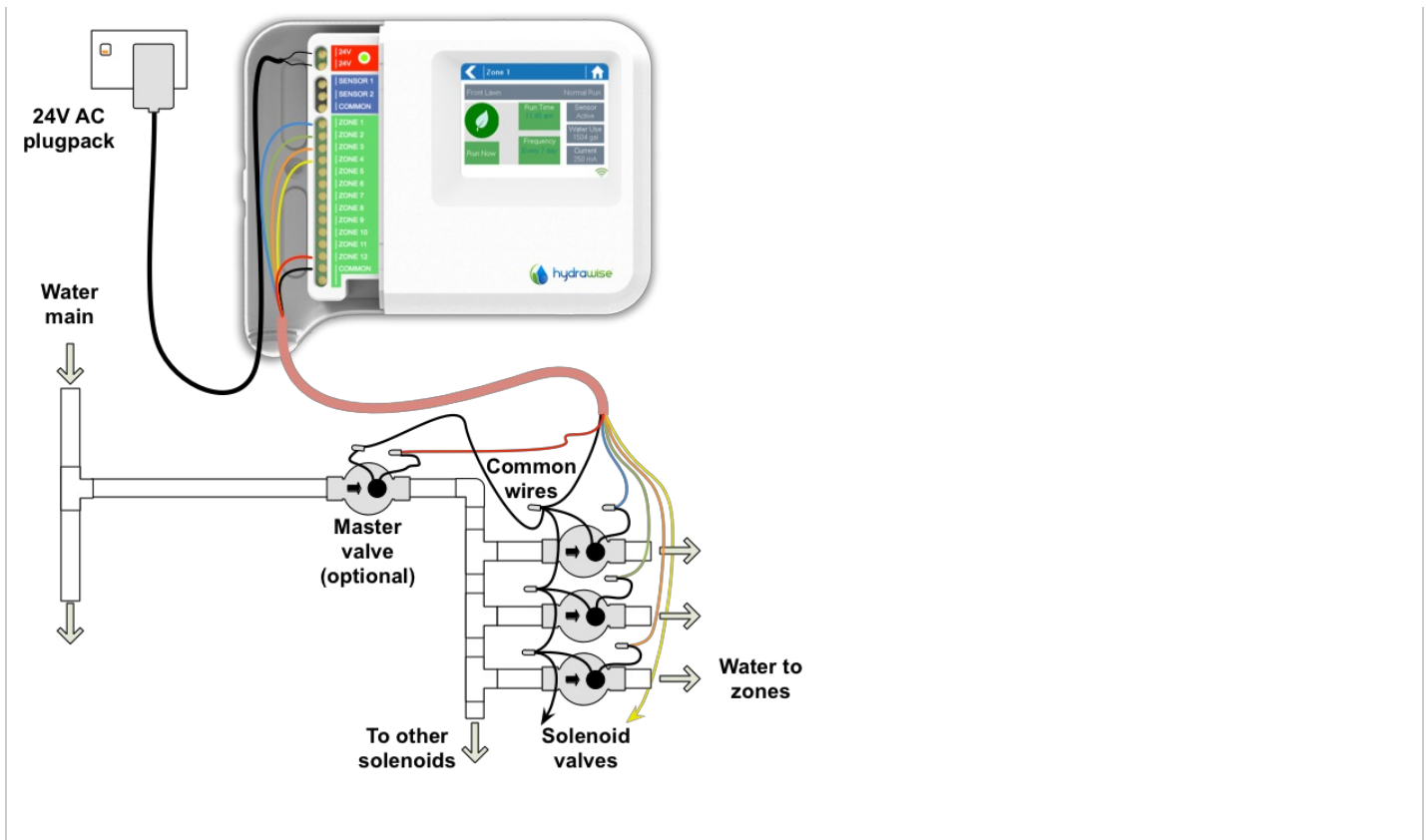

## Master Valve - HC

With a Hydrawise controller, any one of your 6 or 12 zones can be configured to act as a master valve. The master zone is configured on the [Zones and Schedules](#) [64] page above your list of irrigation zones.

The screenshot shows the 'Zones' configuration page in the Hydrawise app. At the top, it says 'Zones' and 'Each of your controller's zones is listed below. When a zone needs to run it will water at the next available Program Start Time.' Below this, there is a 'Master valve:' dropdown menu currently set to 'Not assigned'. Three zone cards are visible:

- Really, really long zone name** (Zone Number - 1):
  - Watering Type: Time Based
  - Frequency: Every valid Program Start Time
  - Schedule Adjustments: Water longer when hot
  - Run Length: 13 mins
  - Cycle & Soak: Enabled
- Zone 2 Long Name** (Zone Number - 2):
  - Watering Type: Smart Watering
  - Peak Watering Frequency: Every 3 days
  - Schedule Adjustments: Waters when estimated moisture level reaches 0%
  - Run Length: 5 mins
  - Cycle & Soak: Enabled
- Zone 3 - Fixed** (Zone Number - 3):
  - Watering Type: Time Based (Daily normal cycle)
  - Frequency: Once a day
  - Schedule Adjustments: Water more often when hot
  - Run Length: 1 mins

Initially, no master valve is configured and all zones on the controller can be used as normal zone valves. To select a master valve, select the relevant zone from the list next to the text that says **Master valve**.

# Master Valve - PRO-HC

With the Pro-HC controller, setting the master valve (MV) is similar. If this was not set correctly in the setup wizard, you can access this from the **Zones and Schedules** section easily.

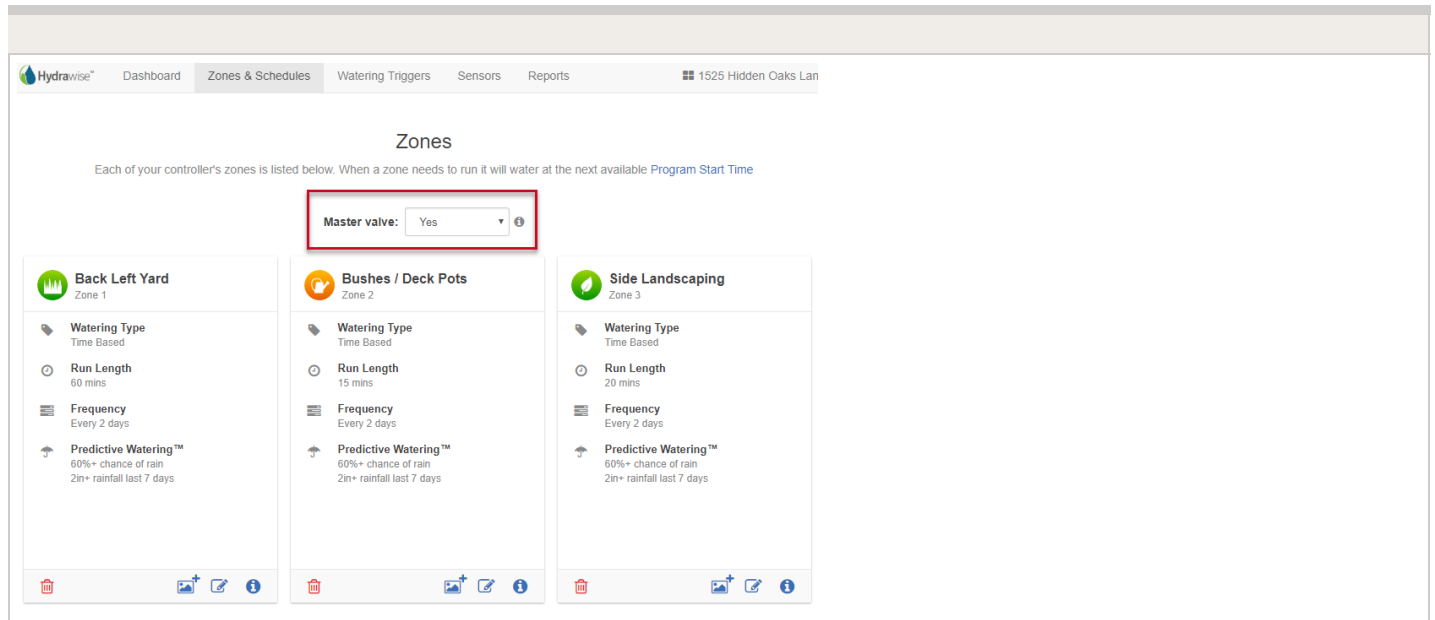

You no longer have to select which zone the MV is connected to, as the option will be different depending on the controller you select when setting up your controller for the first time.

## Master Valve - HPC-FP (Panel for PC-400 controller)

The default is for all stations to have the master valve/pump start circuit ON. The master valve/pump start can be set **ON** or **OFF** by station, regardless of which program the station is assigned.

First, make sure you have the master valve selected "YES" in the box below:

## Zones

ed below. When a zone needs to run it will water at the i

Master valve:  ⓘ

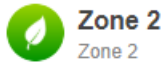

**Zone 2**  
Zone 2

Watering Type

Next, follow the steps for initializing the P/MV for each zone.

1. Click the  icon for the zone in "**zones and schedules**"
2. Click **Next** three times to enter the advanced section or programming.
3. You can now choose either of the following:
  1. Use **Global Master Valve Setting** (Turns the P/MV circuit ON)
  2. Use **Disable Master Valve** (Turns the P/MV circuit OFF)

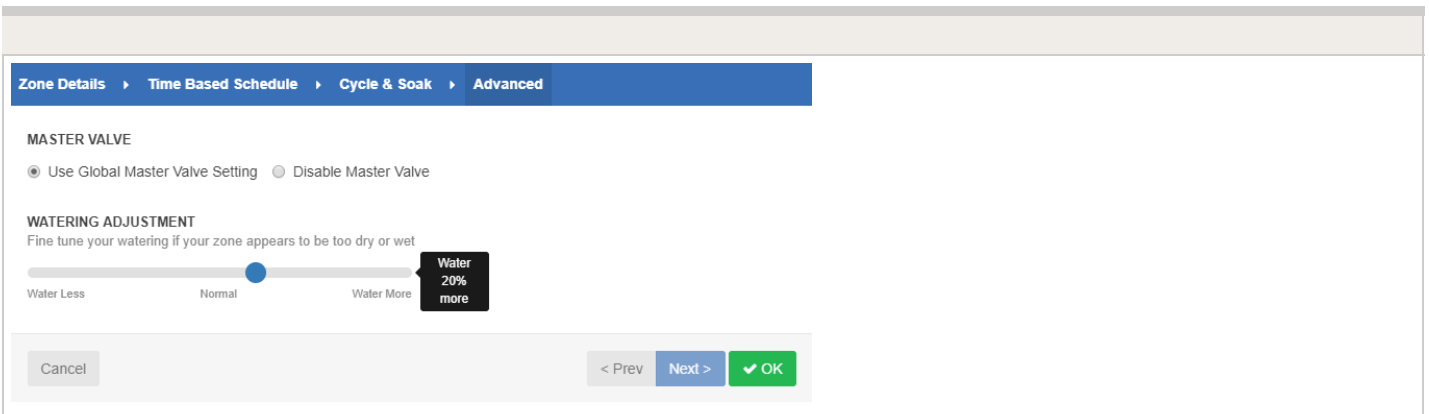

The screenshot shows the 'Advanced' settings page for a zone. At the top, a blue navigation bar contains the following tabs: 'Zone Details', 'Time Based Schedule', 'Cycle & Soak', and 'Advanced'. Below the navigation bar, the 'MASTER VALVE' section has two radio button options: 'Use Global Master Valve Setting' (which is selected) and 'Disable Master Valve'. The 'WATERING ADJUSTMENT' section includes the text 'Fine tune your watering if your zone appears to be too dry or wet' and a horizontal slider. The slider has three labels: 'Water Less', 'Normal', and 'Water More'. A blue dot on the slider is positioned to the right of 'Normal', and a tooltip above it indicates 'Water 20% more'. At the bottom of the screen, there are three buttons: 'Cancel', '< Prev', and 'Next >', followed by a green 'OK' button with a checkmark.

# Valve - Wire Distance

Below is a chart indicating the maximum wire run between the controller and the Hunter AC solenoid valves.

Valve Wire Sizing (Feet)							
Ground	Control Wire						
	18	16	14	12	10	8	6
18	850	1040	1210	1350	1460	1540	1590
16	1040	1340	1650	1920	2150	2330	2440
14	1210	1650	2150	2630	3080	3450	3700
12	1350	1920	2630	3390	4170	4880	5400
10	1460	2150	3080	4170	5400	6670	7650
8	1540	2330	3450	4880	6670	8700	10530
6	1590	2440	3700	5400	7690	10530	13330

## Notes:

Maximum one-way distance in feet between controller and valve heavy-duty solenoid: 24 VAC, 350 mA inrush current, 190 mA holding current, 60 Hz; 370 mA inrush current, 210 mA holding current, 50 Hz

Valve Wire Sizing (Metric)						
Ground	Control Wire					
	0.5	1	1.5	2.5	4	6
0.5	140	190	210	235	250	260
1.0	190	290	335	415	465	495
1.5	208	335	397	515	595	647
2.5	235	415	515	730	900	1030
4.0	250	465	595	900	1175	1405

6.0	260	495	647	1030	1405	1745
-----	-----	-----	-----	------	------	------

**Notes:**

Maximum one-way distance in meters between controller and valve Heavy-duty solenoid:  
24 VAC,  
350 mA inrush current, 190 mA holding current, 60 Hz; 370 mA inrush current, 210 mA  
holding current, 50 Hz