



# TABLE OF CONTENTS

A. Introduction .....	3
B. About the LEIT X & XRC Controllers .....	3
C. Technical Assistance .....	3
D. Copyright and Compliance .....	3
E. Features .....	4
<b>1. System .....</b>	<b>4</b>
1.1 Models available .....	5
1.2 Parts identification .....	5
1.3 Required system components .....	5
1.4 Tools and supply requirements .....	6
<b>2. Installation .....</b>	<b>6</b>
2.1 Valve installation model 160HE-XXX (2-WAY) .....	6
2.2 LEMA Solenoid actuator installation model 1600HE (2-WAY) .....	6
2.3 Wire installation and distance .....	7
2.4 Controller installation .....	7
<b>3. Sensor installation .....</b>	<b>8</b>
3.1 Sensor connection to unused station .....	8
3.2 Sensor connection if station is not available .....	8
3.3 Compatible sensors .....	8
<b>4. Pump or any electrical equipment installation .....</b>	<b>9</b>
4.1 RKIT installation to the MV/Pump terminal .....	9
4.2 RKIT installation to one of the valve station terminal connectors .....	9
<b>5. Programming .....</b>	<b>12</b>
5.1 Manual run .....	13
5.2 Rain stop/restart .....	15
5.3 Monthly budget .....	15
5.4 Check status .....	15
5.5 History reports .....	17
5.6 Setup schedule .....	18
5.7 Setup system .....	20
5.8 Setup radio (LEIT XRC only) .....	23
5.9 Help .....	25
<b>6. Practical troubleshooting point .....</b>	<b>25</b>
6.1 LEIT key .....	25
6.2 LEIT controller .....	26
6.3 LEMA solenoid actuator .....	26
6.4 Hydraulic valves .....	27
6.5 Field control wires .....	27
<b>7. Warranty .....</b>	<b>27</b>
<b>8. LEIT control programming quick reference chart .....</b>	<b>28</b>

## A. INTRODUCTION

Thank you for purchasing DIG LEIT® X or a XRC series controller.

This manual describes how to get the LEIT X or XRC controller up and running quickly. After reading this manual and having been familiarized with the basic functionality of the controller, the manual can be used as a reference for less common tasks in the future.

Please take the time to read through the enclosed instructions and follow them step-by-step.

## B. ABOUT THE LEIT X & XRC CONTROLLER

The LEIT X and XRC Series Controllers are advanced ambient light powered water management irrigation controllers. The LEIT X and XRC use a time tested photovoltaic module, which harnesses light energy to generate electricity that is stored and used to power the controller day and night in any kind of weather.

DIG LEIT irrigation controllers are available in two models: LEIT X (without radio) or LEIT XRC (with radio remote control capability).

The LEIT X and XRC series irrigation controllers have an improved menu base with straightforward programming that allows for a wide range of irrigation programs. Features include four programs with three start times per valve, manual runs with “skip to the next valve” option, rain delays for up to 99 days, budgeting up to 200 percent status checks, review history reports, modify program settings, valve grouping, verify solenoid integrity, radio remote connection (XRC) and more.

Using the LEIT Link remote control handset in conjunction with a LEIT XRC controller, the user can review status and history reports, modify program settings, temporarily interrupt a running program, do a manual run and test or skip to the next valve mode from a distance of up to 800 feet line of site. The current running program and current valve open information is provided when activated. In the Check Status mode the handset can review time, date, budget, sensor activation and solenoid integrity. In Uplink History one can review the hourly usage of each valve by month, or year, including Manual run usage. The LEIT Link handset is a 2-way radio device that can request or send information and commands to a particular LEIT XRC controller and receive confirmation for the information sent or requested.

**IMPORTANT:** The LEIT XRC requires greater energy for radio communication than is used for the controller alone. The LEIT XRC controller requires daily exposure to light levels at a minimum of 10,000 lux, which is equivalent to daylight around 8-10 AM on a cloudy day. On very cloudy days the controller requires more time to charge up and to operate with the radio. In order to retain sufficient energy to maintain control over the valves, the controller radio will automatically turn off in low light conditions. To maximize the energy available, the XRC controller should be installed in an open, un-shaded area.

## C. TECHNICAL ASSISTANCE

Should you encounter any problem(s) with this product or if you do not understand its many features, please refer to this operating manual first. If further assistance is required DIG offers the following customer support:

### Technical Service USA

- DIG’s Technical Service Team is available to answer questions from 8:00 AM to 5:00 PM (PST) Monday-Friday (except holidays) at 800-322-9146
- Questions can be e-mailed to [questions@digcorp.com](mailto:questions@digcorp.com) or faxed to 760-727-0282
- Specification documents and manuals are available for download at [www.digcorp.com/leit\\_control\\_system](http://www.digcorp.com/leit_control_system)

### Customer Assistance outside the USA

Contact your local distributor

## D. COPYRIGHT AND COMPLIANCE

Copyright 2010 DIG Corporation. All rights reserved. LEIT and LEIT Link are registered trademarks. LEIT XRC, LEIT Link Master and LEIT Link Multi-Pro are each, trademarks of DIG Corporation.

Patent #: 5,229,649 and 5,661,349

FCC, EC, Canada and Australia compliance

Important Note for LEIT XRC: To comply with FCC RF exposure compliance requirements, the antenna used for this transmitter is installed to provide a separation distance of at least 8 inches (20 cm) from all persons (not including hands, wrist, feet and ankles). The antenna must not be co-located or operated in conjunction with any other antenna or transmitter.

This device is required to comply with FCC RF exposure requirements for mobile and fixed transmitting devices. This model transceiver generates and uses radio frequency energy. If not installed and used in accordance with the manufacturer's instruction, it may cause interference with radio and television reception. The transceiver has been tested and found to comply with the specification in part 15 of FCC rules for spread spectrum intentional radiators (FCC ID: QLBTSS2003) and FCC part 15 Subpart C, specification.

**Warning:** The user should make no field changes or modifications to the LEIT X, LEIT XRC Controller or the LEIT Link Remote Control Handset.

All adjustments and changes must be made at DIG's facility under the specific guidelines set forth in our manufacturing process. Any change or modification to the equipment will void the users authority to operate the unit, and render the equipment in violation of FCC part 15 subpart C, 15.247. Any tampering with this product will void the warranty.

## E. FEATURES

- Operates 4-28 stations and a master valve or pump start without AC power hookup, batteries or conventional solar panels
- Software in English and Spanish, Italian or French
- 4 programs with 3 start times per program
- Budgeting feature for a yearly watering schedule can be set by month
  - Increase or decrease irrigation from 10-200% in 10% increments
- Review status and history reports
- Review solenoid integrity
- Built to the highest quality control standard
  - Controller functions and operations are 100% tested
  - Controller waterproofing is 100% tested
- Non-volatile memory holds programs indefinitely without batteries
- 2-way radio communication with a LEIT Link handset (model XRC)
- All power is provided by an internal photovoltaic module and microelectronic energy management system fueled by ambient light
  - Functions day or night in all weather conditions and in most outdoor locations
- 365 day calendar with leap year
- Assign-rain, moisture or freeze sensors to an individual valve or to the entire system using SKIT 8821-4 connector
- Manual watering by station or program
- Environmentally friendly - uses clean power
  - No batteries or AC power needed

## 1. SYSTEM

This chapter will explain the components and installation of the LEIT X and XRC series controllers. The LEIT controller must be installed according to the manufacturer's recommendations; failure to do so will void the manufacturer's warranty. The LEIT X and XRC controllers can replace all SOLATROL and ALTEC 8000 controllers and can be mounted on the same column as the ALTEC 8000 by removing the plastic sleeve from the mounting column and mounting the new controller in its place. The LEIT X and XRC can operate with all of the old SOLATROL and LEIT 8000 solenoids, such as LEMA 1500E, 1500-4 and 1500S. We recommend all new installations be done using the 160HE series valves and 1600HE solenoid actuator.

**NOTE: 1500E and 1500S cannot be used on the same terminal.**

### 1.1 Models Available:

LEIT X models available: 10, 12, 16, 20, 24 and X28 stations plus MV/Pump.

LEIT XRC models available: 4, 6, 8, 10, 12, 16, 20, 24 and XRC28 stations plus MV/Pump. LEIT XRC controller utilizes a 2-way radio communication device that operates in the ISM band 902-928 MHz (868/869 Europe). Remote control handset not included.

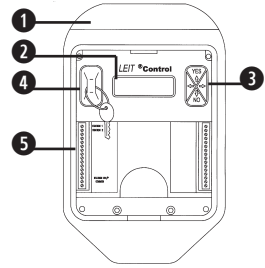

## 1.2 Parts Identification

- 1 PVM – Photovoltaic module harnesses light energy and use it to generates electricity to power the unit day and night in any kind of weather condition.
  - 2 LCD Display – Displays the application stored in the controller.
  - 3 Programming Buttons – Use these 4 buttons to program, modify and review the status of a LEIT XRC controller.
  - 4 Location to insert the LEIT Key – To begin, insert the LEIT Key to enter the LEIT controller's programming screens (use 1, 9-volt battery). The LEIT key is not included.
  - 5 Stations and MV/P Terminal – Up to 28 terminals are available depending on models to connect the valves wires, sensors via the SKIT and the MV/P
- LEIT Door and key – To enter the controller use the key (included) to unlock the door and remove it.



## 1.3 Required System Components

To properly install the LEIT controller, the following components will be needed:

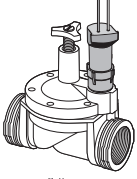
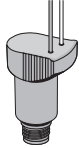
1. Control unit: LEIT series controllers programmed with bilingual software versions SW Ver 2.22 and later EE Ver 2.04 and later (LEIT Key not included).
2. LEIT Key: Programming tool required to enter and program the controller (uses 1, 9-volt alkaline battery) 
3. Mounting column: model MCOLXS (short) 40" (89 cm) or MCOLXL (long) 55" (127 cm) steel pipe including mounting tool kit (2 screws, 2 spacing bolts, 1 hex-key 3/16") 
4. Actuator with in-line valve: each solenoid actuator comes complete with in-line valve (160HE-075 for 3/4", 100 for 1", 150 for 1-1/2" and 200 for 2")   
For drip system use a drip zone assembly model P52-075 that includes a 160HE-075 3/4" valve, 155 mesh screen filter and 30 PSI preset pressure regulator
5. LEMA actuator only : (1600HE) one for each valve being used (see available adapters for mounting on any brand name valve) 
6. 7-solenoid adapters are available to fit most valves:
  - a. Model 30-920 use with BERMAD 200, HIT 500 and DOROT series 80, GRISWOLD 2000 and DW, BUCKNER VB series
  - b. Model 30-921 use with RAIN BIRD DV, DVF, PGA, PEB (3/4" and 1" only), GB, EFB-CP, BPE, PESB (3/4" and 1" only) and ASVF series
  - c. Model 30-922 use with HUNTER ASV, HPV, ICV, PGV, SRV, IBV and AS VF series
  - d. Model 30-923 use with WEATHERMATIC 12000 and 21000 series
  - e. Model 30-924 use with IRRITROL 100, 200B, 205, 217B, 700, 2400, 2500, 2600 series, TORO 220, P220
  - f. Model 30-925 use with SUPERIOR 950, HUNTER HBV, TORO 252 (1.5" and larger)
  - g. Model 30-926 use with RAINBIRD 1 1/2" and 2" PEB and PESB series

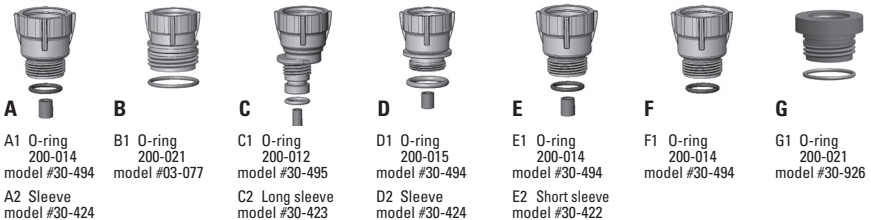
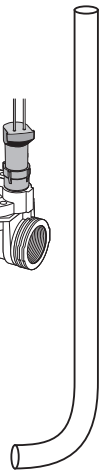

7. Optional: Model SKIT 8821-4 connector: if any sensors are used, a SKIT 8821-4 adapter is required
8. Optional: Model RKIT 8810S relay: if pumps or any electrical equipment are used, an RKIT 8810S adapter is required
9. LEIT Link handset to communicate with a LEIT XRC controller

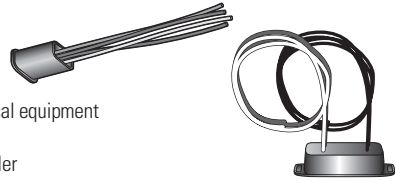

## 1.4 Tools and Supply Requirement

1. Battery: 9-volt alkaline battery for the LEIT Key
2. Standard wire stripper
3. Flathead screwdriver (9/64" or smaller)
4. Concrete: approximately three 90 lb (40 kg) bags
5. Conventional waterproof wire connectors

## 2. INSTALLATION

Select the optimum location for the LEIT X and XRC series controllers. If possible locate the controller in open area not adjacent to a wall or building. We recommend installing a rain sensor with each controller with the use of adapter model SKIT 8821-4.

### 2.1 Valve Installation Model 160HE-XXX (2-WAY)

Recommended version is a complete valve assembly including LEMA solenoid actuator with plastic in-line valve (globe), sizes from 3/4" to 2".

Maximum static operating pressure is up to 150 PSI.

1. Shut off mainline to the valve.
2. Install series 160HE-xxx valves with a solenoid actuator according to a valve standard installation specification (see Figure A on page 7).
3. After installation is completed, turn the water supply on and pressurize the mainline. The valves should open momentarily and then shut off. Test each valve in manual operation by turning the solenoid from left to right to open and right to left to close the valve, making sure that the valve is operating correctly. The valve should open momentarily and then shut off.
4. Splice the solenoid actuator hot wires (red) to one of the color-coded wires. Splice the solenoid actuator white wire to the single incoming white (common) wire. Use 2 conventional dry-splice waterproof connectors. Leave the wires slightly loose on each side so that repairs, if needed, can be carried out easily. Make sure not to exceed the maximum run recommendation of wire distance (see page 7).

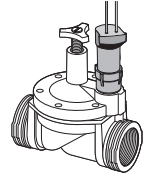

### 2.2 LEMA Solenoid Actuator Installation Model 1600HE (2-WAY)

Select the appropriate adapter for the valve(s) that will be used (see list on page 5). The LEMA solenoid actuator operates only with 2-way normally closed valves.

Maximum static operating pressure is up to 150 PSI.

1. Shut off mainline to the valve.
2. Unscrew the conventional solenoid from the valve and remove the solenoid housing, solenoid stem, plunger, spring, and "O" ring (if necessary). For BUCKNER and SUPERIOR valves, do not remove the existing "O" ring.
3. Select the appropriate conversion adapters for this valve(s) then thread and tighten the conversion adapter clockwise to the compatible valve port, do not over tighten.

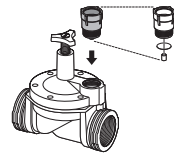

**IMPORTANT:** When installing adapter on BUCKNER and SUPERIOR valves remove the adapter sleeve (model 30-424) before installing.

4. Screw the LEMA 1600HE into the correct adapter. Firmly tighten the solenoid by hand, but do not over tighten.

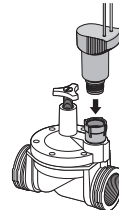

- Positioning the solenoid at a 40-45° angle towards the valve creates a manual lever; helpful for manual on/off.
- After installation is completed, turn the water supply on and pressurize the mainline. The valves will open momentarily and then shut off. Test each valve in manual operation by turning the solenoid from left to right to open and right to left to close the valve, making sure that the valve is operating correctly. The valve should open momentarily and then shut off. If the valve remains open in manual operation, examine the adapter and the sleeve to see that it is installed correctly and the adapter is firmly secured. Do not over tighten the LEMA solenoid actuator to the valve and do not cross thread the adapter into the solenoid cavity.

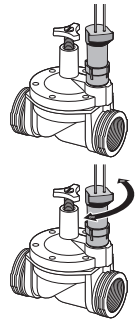

**NOTE: For all brand name valves with internal manual bleed lever, make sure the lever is in closed position. Do not move the lever after installing the solenoid with the valve adapter. If the manual lever on the valve is used, it can damage the adapter or the sleeve causing the valve to stay open.**

- Splice the solenoid actuator hot wires (red) to one of the color-coded field wires. Splice the solenoid actuator white wire to the incoming white (common) wire. Use 2 conventional dry-splice waterproof connectors. Leave the wires slightly loose on each side so that repairs, if needed, can be carried out easily. Make sure not to exceed the maximum run recommendation of the wire distance (see A1 below).

**WARNING:** The LEMA solenoid actuators must not be tested with any AC valve tester or DC tester over 9-volts. If you do so, it will cause irreparable damage to the LEMA solenoid actuator and the controller unit. Testing the solenoids with equipment rated higher than 9-volts will void the warranty.

### 160HE-150 1-1/2" and 160HE-200 2" REMOTE CONTROL VALVE FOR LEIT CONTROLLER ASSEMBLY

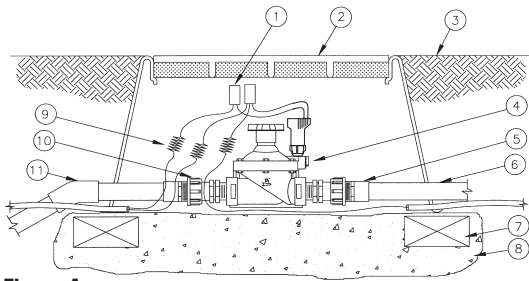

#### LEGEND

- DRY SPLICE WATERPROOF CONNECTORS
- 18" VALVE BOX WITH COVER
- FINISH GRADE TOP
- DIG REMOTE CONTROL VALVE WITH FLOW CONTROL AND LEIT DC SOLENOID  
MODEL: 160HE-150 1-1/2"  
MODEL: 160HE-200 2"
- PVC SCH 40 MALE ADAPTER
- PVC MAIN LINE
- BRICK SUPPORT AT EACH CORNER
- PEA GRAVEL SUMP MINIMUM 3"
- CONTROL WIRE TO OTHER VALVE
- SWIVEL FITTING FOR EASY CONNECTION  
MODEL: 23-152 1-1/2"  
MODEL: 23-202 2"
- PVC SCH 40-45° ELL

**Figure A**

## 2.3 Wire Installation and Distance

Run all direct burial wires along their respective trenches from each valve box to the controller location. Use selection of color-coded direct burial wires to connect to each solenoid red (hot) wire. Use white (common) wire to connect to the solenoid's white (common) wire. Make sure to label each color-coded wire inside the irrigation box with the designated station number.

Wire gauge recommendation	MAXIMUM WIRE DISTANCE	
	LEMA 1500S SOLENOIDS	LEMA 1600 HE SOLENOIDS
14 AWG (2.5 mm <sup>2</sup> )	1500 feet (300 m)	4,500 feet (1365 m)
12 AWG (4 mm <sup>2</sup> )	2400 feet (700 m)	7,500 feet (2272 m)

## 2.4 Controller Installation

- To install the mounting column, set the curved bottom of the mounting column in a 12" x 18" x 12" (30 x 45 x 30 cm) frame and pour in the three 90 lb (40 kg) sacks of cement (see Figure A). Make sure the column is vertical and the opening in the curved bottom is accessible and unclogged. All wires should route to the controller through the bottom of the mounting column (see A1).

**NOTE: Make sure the cement pad is dry before continuing with the installation**

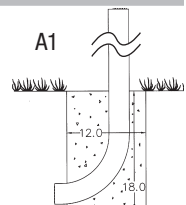

- Run the field wires along their respective trenches from the valve box up to the bottom end of the mounting column. Make sure not to exceed the maximum recommended wire distance (see chart for maximum wire distance on page xxxx). Push the wires up through the column until at least 12" (30 cm) of wire extends from the top of the mounting column (see B1).
- Remove the door from the LEIT controller using the door key (included) and slide the controller into place on top of the mounting column. Make sure that 12" (30 cm) of wires are now inside the controller and cannot slip back down into the column (see C1).
- Insert the two clamp spacers and the two screws (both included with the mounting column) into the holes located on the lower left and right side of the controller. Tighten the screws with the hex-key (included) until the controller does not turn or twist and cannot be pulled off of the mounting column (see D1).

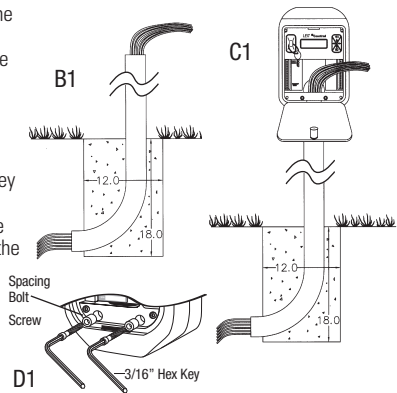

- Connect the station wires to the controller using a standard wire stripper. Strip 3/10" of insulation from the tip of each of the station colored (labeled) wires. Connect the color-coded (hot) wires into the connector strip labeled with the station number and tighten the connector screw using a screwdriver. Connect the white (common) wire into either of the two common wire connectors labeled "common" located at the lower part of the connector strip and tighten the connector screw using a screwdriver. If using a master valve, connect the red (hot) wire from the master valve into the station labeled "MV/P" (see Figure E1). For pump or other electrical equipment, see detailed installations on page 10.

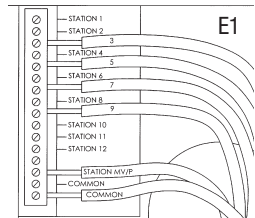

### 3. SENSOR INSTALLATION

The SKIT switch-type, weatherproof sensor adapter provides a quick, reliable way to connect a compatible rain, freeze, moisture or other normally closed, switch-type sensor. The connection can be made either directly to the LEIT series irrigation controllers or to one of the micro-powered solenoid actuators.

#### 3.1 Sensor connection to unused station

If there is an unused station on the LEIT controller, connect the sensor directly using a SKIT 8821-4.

- Run a red (hot) wire from the unused station connector position on the LEIT controller to the red (hot) wire on the SKIT 8821-4. Then run a white (common) wire from the common connector station position on the LEIT controller to the white (common) wire on the SKIT. Finally, splice the two SKIT black wires to the sensor's two normally closed (N/C) wires (see Figure B, Option 1). If possible, choose a solenoid location close to the controller.

#### 3.2 Sensor connection if station is not available:

If station is unavailable, or the controller is too far from the sensor, connect the SKIT 8821-4 to LEMA actuators at a valve closest to the desired sensor location. This method can be used to minimize excessive wire runs (see Figure B, Option 2).

- Choose a valve that is closest to the sensor location and, if possible, choose a sensor location close to the controller. On the installed LEMA series actuator, splice the red (hot) wire to the SKIT's red (hot) wire AND to the red (hot) field wire creating a 3-wire connection. Next, splice the LEMA's white (common) wire to the SKIT's white (common) wire and connect both onto the common field wire. Again, a 3-wire connection should have been created. Finally, splice the two SKIT black wires to the sensor's two normally closed (N/C) wires.

#### 3.3 Sensors compatible with LEIT controllers:

Rain sensors are the HUNTER MINI-CLICK II and the RAIN BIRD RSD.

Moisture sensors are the IRROMETER RA and TGA series.

Freeze sensor is the HUNTER FREEZE-CLICK.



## SENSOR INSTALLATION OPTIONS

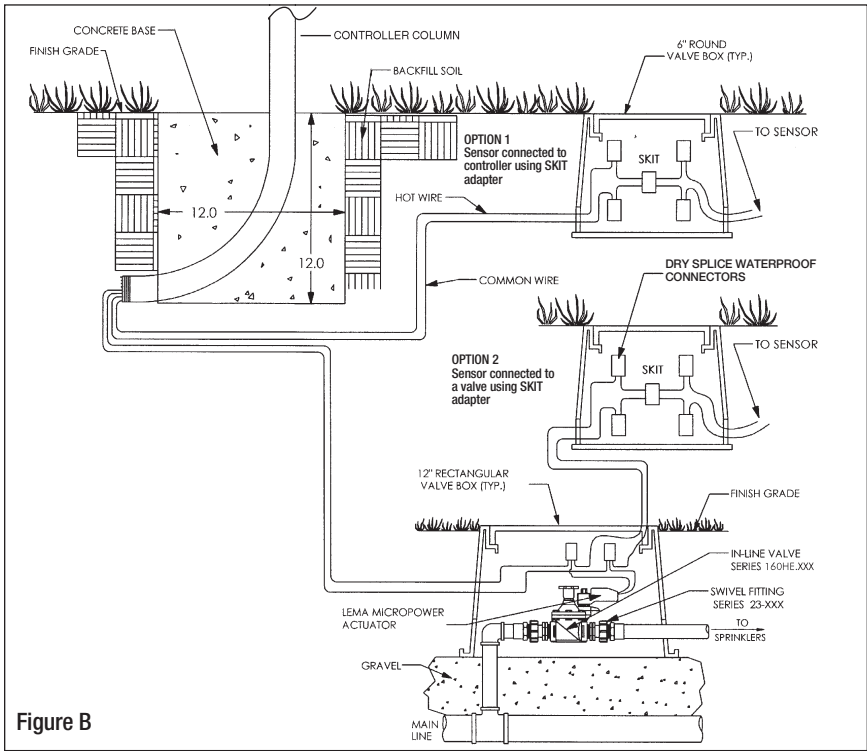

Figure B

## 4. PUMP OR ANY ELECTRICAL EQUIPMENT INSTALLATION

If it is required to switch ON a pump, fertilizer injector, fountain or light, two connection options are available using the RKIT 8810S relay interface module.

The RKIT 8810S units are used to switch 10 amp electrical circuits to a voltage up to 240V AC or 30V DC.

**NOTE:** *RKIT 8810S can be used with LEIT Series 4000, X and XRC.*

### 4.1 RKIT Installation to the MV/Pump Terminal

To operate all the valves with the unit connected to (e.g. pump), connect the RKIT to the MV/Pump terminal (see Figure C).

### 4.2 RKIT Installation to One of the Valve Station Terminal Connectors

Operate only the valve number that RKIT has been installed to (e.g. Fountain will turn on/off by only the station that is using the RKIT).

To install the RKIT, run a red (hot) wire from the RKIT to any of the controller station terminals. Then, run a white (common) wire from the RKIT to the common terminal connector or if not available, splice it to the common field wire using a waterproof connector. Run the two black wires from the RKIT to the AC/DC equipment and connect them to the corresponding circuit to be switched (e.g. pump start relay).

Make sure to use waterproof dry-splice connectors for all connections.

**NOTE:** *If the RKIT is connected to any circuit higher than 24-volts, it must be located in its own high voltage junction box in accordance with local electrical code.*

If a pump start relay coil current is greater than 2A (Model 8810S 2A up to August 2007) or 10A (Model 8810S 10A after August 2007) use a pilot relay.

**WARNING:** RKIT cannot be housed in the same box with any low voltage equipment.  
Do not connect the RKIT to a circuit higher than 380-volts.

## ELECTRICAL EQUIPMENT RELAY INTERFACE CONNECTION

### LEGEND

1. FINISH GRADE
2. 6" ROUND VALVE BOX
3. RKIT ADAPTER PART NO. 8810-S. USE WITH EACH SENSOR
4. RED WIRE TO THE MV/PUMP TERMINAL OR ANY STATION TERMINAL
5. WHITE WIRE TO THE COMMON TERMINAL
6. DRY SPlice WATERPROOF CONNECTORS (4)
7. TO AC/DC EQUIPMENT OR PUMP START RELAY

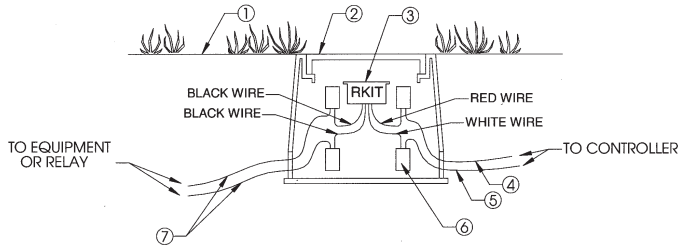
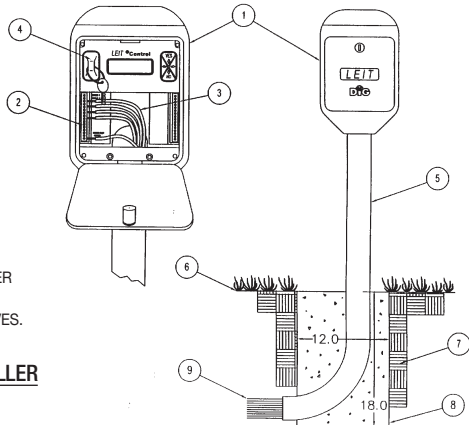

Figure C

## CONTROLLER INSTALLATION

### LEGEND

1. MODEL XRC WITH RADIO REMOTE 4 TO 28 STATIONS.
2. TERMINAL STRIP
3. 12 OR 14 GAUGE WIRE.
4. PROGRAMMING KEY. MODEL #: LEIT KEY
5. 35" STEEL MOUNTING COLUMN. MODEL NUMBER: MCOLXS (SHORT) 50" STEEL MOUNTING COLUMN. MODEL NUMBER: MCOLXL (LONG)
6. FINISH GRADE.
7. 6-1/2" OF BACKFILL SOIL.
8. POURED CONCRETE BASE - 1-1/2 CU.FT. INSTALL PER MANUFACTURER'S INSTALLATION GUIDE.
9. DIRECT BURIAL CONTROL WIRES TO CONTROL VALVES.



## 1 LIGHT ENERGIZED IRRIGATION CONTROLLER LEIT CONTROL X AND XRC

## SENSOR INSTALLATION

### LEGEND

1. "MINI CLIK" RAIN SENSOR.
2. DIG PLASTIC PIPE CAP - 1" CAP PART NO. 23-001 OR 1.5" CAP PART NO. 23-153 WITH HOLE FOR WIRES.
3. DRILL TWO 3/16 HOLES IN PIPE FOR SENSOR BRACKET.
4. (2) #8-32 MACHINE SCREWS WITH WASHER, LOCK WASHER AND NUT.
5. 1" OR 1.5" GALVANIZED PIPE 6 TO 10 FEET HIGH.
6. 12"x12" CONCRETE BASE 8" DEEP MINIMUM.
7. 1" OR 1.5" PIPE ELBOW.
8. FINISH GRADE.
9. 6" ROUND VALVE BOX.
10. PART NO. SKIT ADAPTER 8821-4 USE WITH EACH SENSOR.
11. TO CONTROLLER OR VALVE.
12. (4) DRY SPlice WATERPROOF CONNECTORS.
13. NORMALLY CLOSED WIRE FROM SENSOR.
14. COMMON WIRE FROM SENSOR.
15. 1" OR 1.5" NIPPLE.
16. GRAVEL.

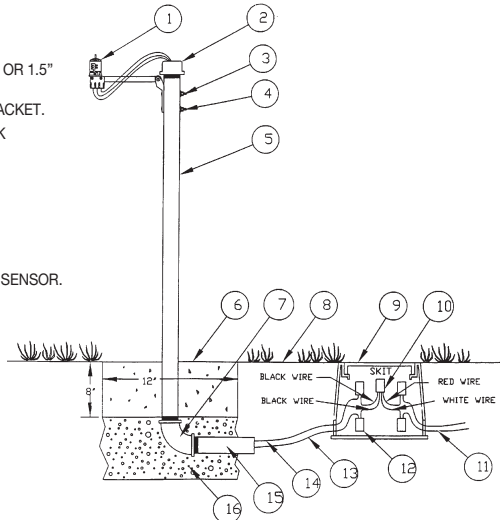

## 2 RAIN SENSOR ASSEMBLY COLUMN MOUNTED

# VALVE INSTALLATION

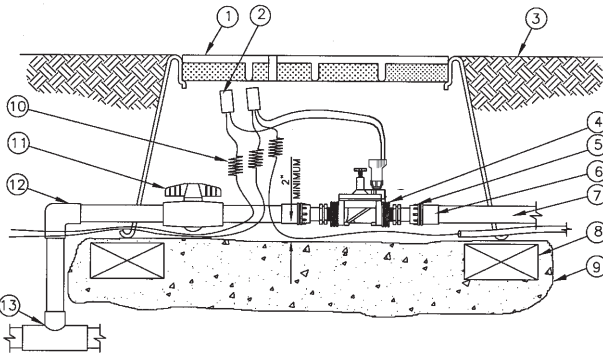

**3** 160HE-075 3/4" AND 160HE-100 1" REMOTE CONTROL VALVE ASSEMBLY

- ① VALVE BOX WITH COVER 18" SIZE.
- ② DRY SPLICE WATERPROOF CONNECTORS
- ③ FINISH GRADE TOP.
- ④ DIG VALVE MODEL 3/4" 160HE - 075 1" 160HE -100
- ⑤ SWIVEL FITTING DIG MODEL 3/4" 23-004, 1" 23-003.
- ⑥ PVC SCH 40 MALE ADAPTER.
- ⑦ PVC LATERAL LINE.
- ⑧ BRICK SUPPORT AT EACH CORNER.
- ⑨ PEA GRAVEL SUMP - MINIMUM 3".
- ⑩ 12 OR 14 GAUGE WIRE.
- ⑪ BACK-UP NPT PVC BALL VALVE.
- ⑫ PVC SCH 40 90 DEGREE ELL.
- ⑬ SCH 40 TEE.

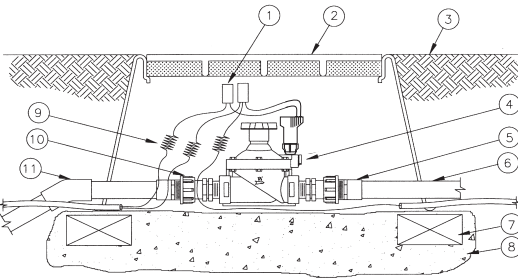

**4** 160HE-150 1-1/2" and 160HE-200 2" REMOTE CONTROL VALVE FOR LEIT CONTROLLER ASSEMBLY

- LEGEND
- ① DRY SPLICE WATERPROOF CONNECTORS
  - ② 18" VALVE BOX WITH COVER
  - ③ FINISH GRADE TOP
  - ④ DIG REMOTE CONTROL VALVE WITH FLOW CONTROL AND LEIT DC SOLENOID MODEL: 160HE-150 1-1/2" MODEL: 160HE-200 2"
  - ⑤ PVC SCH 40 MALE ADAPTER
  - ⑥ PVC MAIN LINE
  - ⑦ BRICK SUPPORT AT EACH CORNER
  - ⑧ PEA GRAVEL SUMP MINIMUM 3"
  - ⑨ CONTROL WIRE TO OTHER VALVE
  - ⑩ SWIVEL FITTING FOR EASY CONNECTION MODEL: 23-152 1-1/2" MODEL: 23-202 2"
  - ⑪ PVC SCH 40-45° ELL

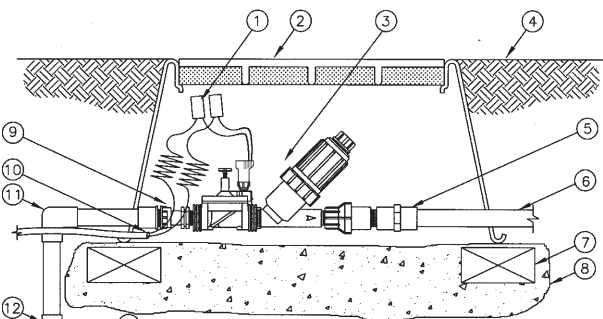

- ① DRY SPLICE WATERPROOF CONNECTORS
- ② VALVE BOX WITH COVER 12" SIZE
- ③ DIG LEIT 3/4" REMOTE CONTROL VALVE ASSEMBLY MODEL P52-075
- ④ FINISH GRADE TOP
- ⑤ 3/4" FEMALE NPT COUPLING x SLIP
- ⑥ PVC LATERAL LINE
- ⑦ BRICK SUPPORT AT EACH CORNER
- ⑧ PEA GRAVEL SUMP MINIMUM 3"
- ⑨ SWIVEL FITTING DIG MODEL 23-004 1" F X 3/4" M
- ⑩ CONTROL WIRE TO OTHER VALVE
- ⑪ PVC SCH 40 90 DEGREE ELL
- ⑫ SCH 40 TEE
- ⑬ MAIN SUPPLY LINE

HEAD LOSS								
FLOW RATE(GPH)	5	9	13	18	22	26	31	36
VALVE HEAD LOSS	3	3	4	4.3	5	5.5	7	8.5
FLOW RATE(GPH)	5	8	11	16	19	22	25	
FILTER HEAD LOSS	0.2	1.8	2.0	4.3	7.2	7.8	12.0	
FLOW RATE(GPH)	4	10	13	15	18	20	22	
REGULATOR HEAD LOSS	2	5	7	8	9.5	13	16	

**5** P52-075 3/4" REMOTE CONTROL VALVE ASSEMBLY FOR A DRIP SYSTEM WITH A 155 MESH FILTER AND 30 PSI PRESET PRESSURE REGULATOR

## 5. PROGRAMMING

This chapter explains the controller buttons hierarchy and how to review, modify settings, program the controller, or to perform a manual run. To enter the controller, the user needs a LEIT Key or the LEIT Link handset (LEIT XRC). Insert the LEIT KEY into the controller key slot and follow the steps below. After the information on the screen comes to view, the user can select the language, then review, program, modify setting or perform a manual run. For Programming Quick Reference, see the back page of this book or inside the door panel on the controller.

### The controller is programmed with the aid of 4 buttons

 Use to accept the desired programming mode, select a parameter and raise (increase) the value of the selected parameter.

 Use to deselect a parameter and lower (decrease) the value of the selected parameter.

 Use to move the cursor to left.

 Use to move the cursor to right.

To move between applications (left to right) use the right or left arrow buttons. To enter an application (Moving up) uses the YES button.

### INSERT LEIT KEY INTO THE SOCKET IN THE UPPER LEFT CORNER OF THE CONTROLLER

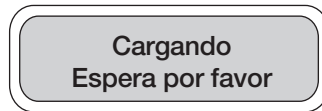
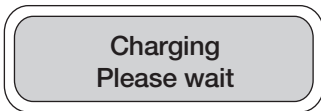

The above screens appear while the controller is charging

**NOTE: If the controller is being programmed for the first time under a low light level it may take up to 5 minutes to charge the controller using the LEIT Key.**

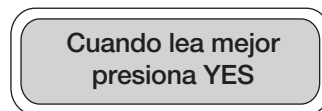
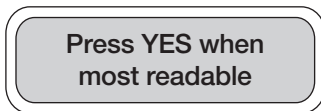

The above alternating screens appear when the LEIT controller is fully charged. When the characters are most readable, press  to select the language to use and continue to the next screen.

This screen identifies the controller model and the number of stations it has. Press  to continue.

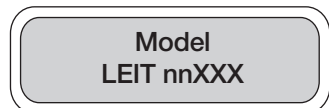

This screen appears identifying the software versions that are installed in the controller. Press  to continue.

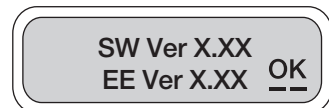

This screen appears with the date and time. If the controller is being programmed for the first time it will not display the correct time and date. Update this screen in the next few

steps. Press  to continue.

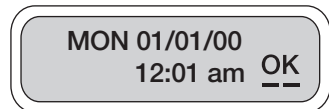

## 5.1 MANUAL RUN

### Setting up a Manual Run







The Manual Run is useful for checking the proper operation of stations (especially after installation), for applying additional water as required, or for testing the valves.







The first option available on the main menu is to perform a Manual Run.

The Manual Run feature allows one to suspend a program or valve watering schedule, test a selected valve, select a temporary program and skip any valve if needed. Note that at the completion of Manual Run any programmed irrigation schedule reverts back to normal operation.

To enter Manual Run press , to skip Manual Run, press .

**Manual Run feature overrides any Sensor Reading, Rain Stop, or Budgeting.**

If a program or valve is running, select Yes or No to continue (this screen will not be shown unless a valve is open). Press  or  and underscore Yes or No, then press  to select. Press  or  again to underscore OK. Press  to continue.







If a valve is open, one of the options; Suspend Program # or Stop Valve # must be selected. To continue, press  or  and underscore one of the options, then press  to select. Press  or  again to underscore OK. Press  to continue.







In this screen confirm one of the options that has been selected in the last screen.

If Stop Valve is selected the valve # selected will closed.

If Suspend Prog is selected, a screen appears which shows valves stopping then "Program # stopped for Today". Press  to continue.

This screen allows the user to select a stored or temporary program or to exit the program. If Stored is selected the controller will run the stored program available. If Temp is selected, a run time for each valve can be added to start a temporary run time. After the temporary run time has initiated, the user can skip valves at any time.

To set up a temporary program: press  or  and underscore Temp, then press  to select. Press  or  again to underscore OK. Press  to continue.

To schedule Valve Run Time press  or  and underscore the hour or minute digits, then press  or  and select a duration. When finished, press  or  again to underscore OK. Press  to continue to the next valve. Repeat the same procedure for the remaining valves. To

skip any valve, simply set the runtime to 0, then underscore OK and press  to continue to the next valve. To exit, pass through the remaining valves.

If all valve durations are set to 0 a screen with "Program is Less Than 1 Minute" appears.

**NOTE: The remaining stations will display the runtime of the previous stations unless manually changed.**

MANUAL  
RUN?

Stop Prog/valve?  
 Yes  No OK

Suspend Prog:      
 Stop Valve:     OK

Are you Sure?  
 Yes  No OK

Run Prog.  None  
 Stored  Temp OK

Valve #1     0:01  
Runtime:    
  OK



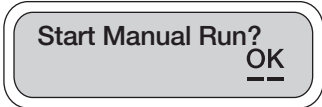

Press  to start Manual Run (if within the spray area, remove the LEIT Key, replace and lock the LEIT Controller door to protect the controller). The LEIT Controller will start the manual run immediately, running each valve for the programmed duration that has been selected.

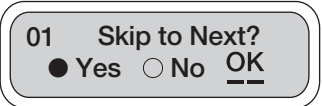







If the LEIT Key was not removed and station 1 has been visually confirmed to be operating properly, press  to skip to the next valve.

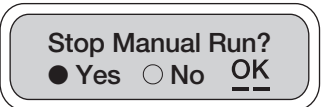



**NOTE: If the open or short circuit tests option has been selected (see setting the controller system) and if the solenoid wiring is faulty the fault status is displayed**

Follow the same procedure for station 2 and the remaining stations. When temporary Manual Run has been completed, the screen will return to Manual Run. To stop Manual Run press  or  and underscore No. Press  or  again to underscore OK. Press  to continue.



In the Stop Manual Run screen, press  or  and underscore YES, then press  to select. Press  or  again to underscore OK. Press  to continue. Manual run will

stop and the screen will return to Manual Run screen. To continue Manual Run underscore NO, press  or  again to underscore OK. Press  to continue skip to next valve.

## 5.2 RAIN STOP/RESTART

### Setting up a temporary suspension of all irrigation programs

The Rain Stop feature is used to temporarily suspend all irrigation programs. For example, during rainy weather, regularly scheduled programs can be stopped for periods from 1-99 days. At the end of the designated period the regularly scheduled programming will resume automatically.





To enter Rain Stop/Restart press . Press  to skip Rain Stop and to move to the next feature.

Passwords screen provide the user a security against

unauthorized changes being made to the system. The Default password is AAA. If the password has not been changed



press  to continue. If the password has been changed, enter

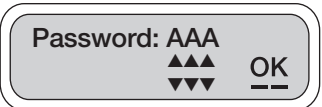

the new password to continue. To enter the new password press  or  and underscore the digit to

be changed, then press  or  to select the appropriate letter. Repeat the steps for each letter. When finished, press  or  to underscore OK. Press  to continue.



To implement a Rain Stop press  or  and underscore 0

days. Press  or  and enter the number of days needed

to suspend irrigation (from 1-99 days). Press  or  to

underscore OK. Press  to continue.

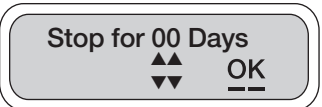

Rain Stop will cancel itself automatically at 12 AM on the last day of the programmed setting.

If Rain Stop is active it can be canceled manually anytime in the Cancel Rain Stop screen. Once there, press or to underscore Yes and press to select. Press or again to underscore OK. Press to continue, this will bring back the Rain Stop screen.

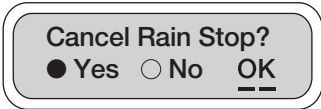

### 5.3 MONTHLY BUDGET

#### Setting a Monthly Budget

Instead of changing the duration for each program, the Monthly Budget feature is used to increase or decrease the amount of water used during seasonally dry or wet periods on a monthly basis.

Budget adjustments can range from 10-200% in 10% increments. The LEIT controller will automatically adjust the previously programmed duration for each program according to the specified budget entered for each month.

To enter Monthly Budget, press . Press to skip Uplink Budget and to move to the next feature.



The password screen provides the user a security against unauthorized changes being made to the system. The Default password is AAA. If the password has not been changed press to continue.

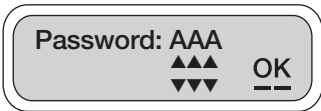

If the password has been changed, enter the new password to continue. To enter the new password press or and underscore the digit to be changed, then press or to select the appropriate letter. Repeat the steps for each letter. When finished, press or to underscore OK. Press to continue.

Budget information for the previous 12 months will appear with January first and 100% as the default. Press the or to underscore the percentage digits. Press to increase or to decrease the percentage (in increments of 10%). Press or to underscore OK. Press to advance to the next month.

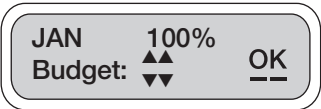

Repeat this procedure for the remaining months as needed. To skip a month, press . Pass thru the 12 months to return to the Monthly Budget screen. Press to continue.

**NOTE: To enable or disable an individual station to be budgeted see Setup System menu on page xx**

### 5.4 CHECK STATUS

#### Review the Controller Status

This feature allows the user to review the current controller status for the time, date, sensor activation, active program, if any valve is open, manual run, rain stop progress and short or open circuit in valve wiring. It also provides information on the controller's availability for communication (LEIT XRC only).

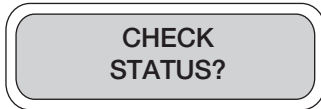

To enter Check Status press . Press to skip Check Status and move to the next feature.

This screen appears if any program or valve is active. Press  to continue.

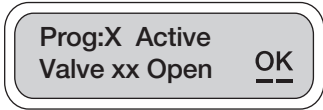

This screen appears if any program or group of valves is active. Press  to continue.



This screen appears if a Manual Run is in progress. Press  to continue.



This screen appears if Rain Stop is active. Press  to continue.



This screen appears if irrigation has stopped for a full month. Press  to continue.



If the test is enabled in Setup System, this screen appears if the valve wiring is open. Press  to continue.

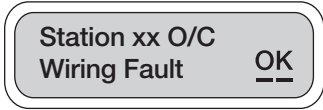

If the test is enabled in Setup System, this screen appears if there is a short in the wiring. Press  to continue.

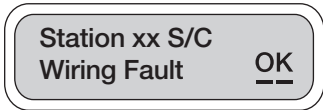

This screen appears with the current date and time of the day. Press  to continue.

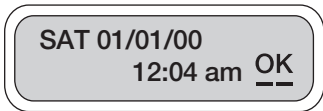



This screen appears when the controller is running in local mode. Press  to continue.

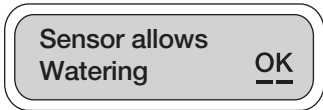

**NOTE: This screen is available only on model XRC with radio remote capability.**

This screen appears when the sensor allows watering. Press  to continue.



This screen appears if no sensor is used. Press  to continue.

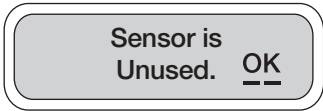



## 5.5 HISTORY REPORTS

### Review The Controller History Reports

This feature allows the user to review the controller operating history reports for a total watering time for each valve with overall total and manual run total. This information is available for the current month and the previous 11 months.

To enter History Report press . Press  to skip History Report and move to the next feature

**HISTORY  
REPORT?**

This screen shows total time usage for each valve for the current month. Press  to continue.







**Valve# TOT This  
Month: 4:30** **OK**  
\_\_

This screen shows total time usage for the current month. Press  to continue.

**JAN06 TOTAL  
Month: 12:34** **OK**  
\_\_

This screen shows total manual run usage for the current month. Press  to continue.

**JAN06 MANRUN  
Month: 0:30** **OK**  
\_\_

These screens allow a review of information on a specific month. To review this information, select Yes for the selected month or No to skip to the next month. Press  or  and underscore Yes or No, then, press  to select. Press  or  again to underscore OK. Press  to continue.

**DEC05 Tot/Valve**  
 Yes  No **OK**  
\_\_

If any month is selected this screen shows the total time usage for each valve in the selected month. Press  to continue.

**NOV05 Tot/Valve**  
 Yes  No **OK**  
\_\_

If any month is selected this screen shows the total time usage for the month select. Press  to continue.

**NOV05 TOTAL  
Month: 12:50** **OK**  
\_\_

If any month is selected this screen shows the total manual run time usage for the selected month. Press  to continue.

**NOV05 MANRUN  
Month: 1:30** **OK**  
\_\_

These example screens provide the monthly watering totals as requested. This information is available by month for the previous 11 months.

## 5.6 SETUP SCHEDULE

### Review or change the Programming Schedule

This feature allows the user to review, change or set a schedule with up to four separate programs for each station, each with up to three individual start times per day. It also allows the user to group stations together.

SET UP  
SCHEDULE?

**NOTE: Be careful not to exceed hydraulic limitations.**

To enter Setup Schedule press . Press to skip Setup Schedule and to move to the next feature.

The Default password is AAA. If the password has not been changed press to continue. If the password has been changed, enter the new password to continue.

Password: AAA  
▲▲▲  
▼▼▼

To enter the new password press or and underscore the digit to be changed, then press or to select the appropriate letter. Repeat the steps for each letter. When finished, press or to underscore OK. Press to continue.

### SELECTING A PROGRAM NUMBER

This screen displays a choice of 4 programs. Program #1 is highlighted by default. Press to continue programming

Program Number:  
● 1 ○ 2 ○ 3 ○ 4

Program #1. To select another program, underscore the program number using or and press to highlight the program number. Press the or to underscore OK. Press to continue.

**NOTE: Additional programs will not run unless you have activated the program number.**

### SETTING WATERING CALENDAR

This screen provides watering frequency options. To select the preferred option, press or and underscore one of the 4 options. Press to select. Press or again to underscore OK. Press to continue.

○ Every.. ○ Even  
● MTWTFSS ○ Odd

### WATERING FERQUENCY OPTIONS INCLUDE:

**Every:** operates stations from once a day to once every 39 days

**Even:** every even-numbered day

**Odd:** every odd-numbered day

**MTWTFSS:** select specific day(s) of the week

**NOTE: If MTWTFSS is selected, in the next screen select the day of the week.**

If the specific day(s) of the week screen has been selected.

Underscore the appropriate box of the preferred day using or and press to confirm. The selected day will show a

Water MTWTFSS  
Days:

checkmark instead of the empty box. Repeat the steps again to select other days. When all desired days are selected, press or to underscore OK. Press to continue.

To de-select a day press .

## SETTING START TIME

In this screen select up to 3 start times per day (including AM or PM). To select the first start time underscore the appropriate digit using the or . Then, press to increase to decrease the value of the appropriate digit. Repeat the steps again for each digit. When finished, press or again to underscore OK. Press to continue.

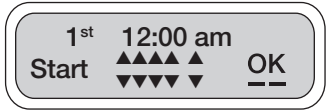

If a second start time is needed, underscore and highlight Yes using or . Press to select. Press or again to underscore OK. Press to continue. Repeat the steps for a second and third start time settings.



**NOTE: You can later cancel any of the additional start times simply by selecting No instead of Yes within each start time.**

## SETTING WATERING DURATION

When scheduling or changing a watering duration time for each valve, note that a runtime from 1 minute to 5 hours and 59 minutes in 1minute increments can be set. Any number of valves can operate at the same time if hydraulic limitations are not exceeded.

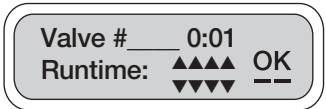

To set the valve duration, underscore the appropriate digits using the or . Press to increase or to decrease the hour or minute digit. Press or again to underscore OK. Press to continue to the second valve. Follow the same procedure as before for the second and remaining valves. To skip a valve, leave the duration on zero and press to continue.

**NOTE: The duration selected for each valve will be repeated with each of the three start times (if used).**

## GROUPING VALVES TO OPERATE AT THE SAME TIME

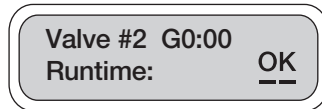
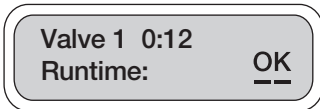







In the Valve Runtime screen the user can program more than one valve to open or close together in a group as opposed to the normal operating mode (one valve at the time). To select valves to be grouped together for operation at the same time, set the duration for the first valve and add the letter G to the rest of the valves in this group. The first valve and the remaining valves are now linked together.

**Example: Linking Valve #2 to Valve #1**

Set a run time for Valve #1. While in the Valve #2 Runtime screen, press or and underscore the icon left of the hour position. Press and the letter G will appear. Press or again to underscore OK. Press to confirm.

The letter G signifies that Valve #2 is now grouped to Valve #1, with Valve #1 being the group leader. The watering time for this group leader will be applied to all consecutive valves that show the letter G in the

Valve Runtime screen. Press  or  and underscore the letter G located to left of the hour digit in the runtime screen to remove the letter G (group leader) from a group of valves. Press  and the letter G will disappear. Repeat with the other valves as needed. Press  or  again to underscore OK. Press  to continue.

The following examples are of groups (G or 0 can be set for intermediate valves in a group). It is possible to set more than one group.

Valves #1-4 grouped with runtime of 20 min.	Valves #5 and 6 not grouped	Valves #7-10 grouped with runtime of 25 min.
Valve #1 set for 0:20 minutes	Valve #5 with runtime of 10 min.	Valve #7 set for 0:25 minutes
Valve #2 set for G0:00 or 0:00	Valve #6 with runtime of 15 min.	Valve #8 set for G0:00 or 0:00
Valve #3 set for G0:00 or 0:00		Valve #9 set for G0:00 or 0:00
Valve #4 set for G0:00		Valve #10 set for G0:00

**NOTE: When selecting or changing a grouped setting, cycle through all the valves on this setting to save the changes before exiting.**

**IMPORTANT:** Using valves grouping

1. For any valve number that is assigned to a group leader and the G is disabled, there are two options available:
  - a. If any unassigned "Valve Runtime" is left on 0, the valve will be a slave within a group.
  - b. A runtime may be entered for this valve making up the valve a new group leader or for stand-alone operation.
2. If any of the assigned group leaders are disabled by setting runtime (duration) to 0:00, there are three options available:
  - a. If the setting of a group leader is 0 ("Valve # Runtime"), there is no preceding valve within a group; a default run time of one minute is used by Valve #1 to prevent from disabling the complete group setting.
  - b. If a valve is assigned as a second group leader and the setting for this valve has been changed to 0. All the valves attached to the disabled group leader will become part of the preceding group.
3. Valves can be grouped in one program and run separately in another.
4. The master valve will be operating for all/any valves in the group that are selected in system setup.
5. If a moisture sensor governs the lead valve of a group, this will govern the operation of the entire group, regardless of the individual (sensor governs) selections of the slave valves.
6. If operating individually in another program, all valves will follow their own sensor selections. Be very careful not to duplicate or overlap schedules.
7. If any of the programs are not finished by the start of the following program, the second program will stack up to start later.
8. Make sure that programs do no overlap.
9. A manual run can interrupt a running program, which will resume at the completion of the manual run

**5.7 SETUP SYSTEM**

**Setting the Controller System**

The Setup System menu allows the user to set the current controller date and time, activate or de-activate programs, activate or deactivate the budget, enter or change master valve/pump settings, and activate monthly irrigation suspension. In this menu the user can also activate a feature that checks the solenoid for shorts or open wires, activate a sensor, assign a sensor to one valve, all valves or a MV/P and change the passwords.

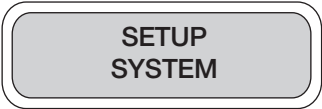

To enter Setup System press  . Press  to skip Setup System and move to the next feature

Passwords screen provide the user a security against unauthorized changes being made to the system. The Default password is AAA. If the password has not been changed

press to continue. If the password has been changed, enter the new password to continue. To change a password scroll to Change a Password screen at the end of Setup System. To enter the new password press or and underscore the digit to be changed, then press or to select the appropriate letter. Repeat the steps for each letter. When finished, press or to underscore OK. Press to continue.



This screen displays the current time. To set the time, underscore the hour digits using or and press or to change the value of the appropriate digit. Press to move to the next digit. If needed, repeat the steps for the minutes and AM/PM digit. After setting the time, press or again to underscore OK. Press to continue.



To set the date, underscore the appropriate digits using or and press or to change the value of the appropriate digit. Press to move to the next digit and if needed, repeat the steps. After setting the calendar. Press or again to underscore OK. Press to continue.

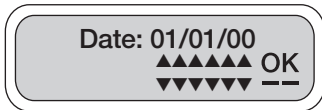

**NOTE: Scheduled programs will not run unless the appropriate program number is activated and a checkmark appears in the Active Program box.**

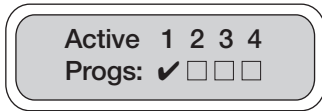

In this screen, up to 4-programs can be activated or deactivated. Program #01 is active (checked) by default. To enable the controller to activate or cancel any of the stored programs simply add or remove the checkmark. Press or to underscore the program number press to activate (checked) and to deactivate. Repeat the steps to activate and deactivate additional programs as needed. Press or again to underscore OK. Press to continue.

This screen presents an option to shut-off irrigation for any month of the year. All the months are active and No is selected by default. To select press or to underscore YES, then press to select. Press or again to underscore OK. Press to continue.



If Yes is selected in the above screen then, this screen shows the months of the year active (checked). To deactivate any month, press or to underscore the appropriate month and press to deactivate (remove the checkmark). To enable the



controller to continue irrigation at any month of the year, simply add back the checkmark. Repeat the steps to activate or deactivate any additional months. Press or again to underscore OK. Press to continue.

This screen tests the solenoids for shorts and/or open wires. In this screen, the Short and Open valve test is deactivated by default (not checked). To enable the controller to activate one

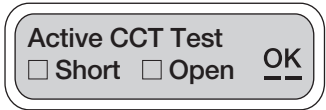

or both of the two Short or Open features, simply add a checkmark. Press or to underscore the appropriate box and press to activate (checked) and to deactivate. Repeat the steps to activate or deactivate the other option. Press or again to underscore OK. Press to continue.

**NOTE: The valve testing takes place when the valve is operated. Fault status will appear in Check Status menu or during a Manual Run.**

In this screen there are two options available for each valve. By default all valves in the budget are activated and MV/P is deactivated. This screen allows the user to activate or deactivate each valve independently.

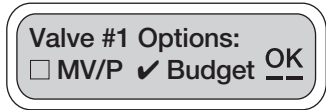

**Option One MV/P:** If checked, the valve number will operate with master valve or pump.

**Option Two Budget:** Is checked by default, the valve number is affected by the monthly budget setting.

To enable the controller to use any or both of the two features, simply add or remove the checkmark from each valve. Press or to underscore the appropriate box and press or to activate (checkmark) or deactivate (remove the checkmark). Press or again to underscore OK. Press to continue

The Sensor In Use feature indicates whether or not a sensor is activated and in use. If a sensor is installed, select Yes.

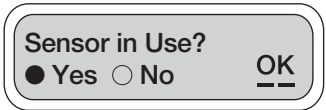

To enable the controller to use a sensor, the first step is to indicate that a sensor is being used. Press or and underscore Yes or No, then press to select. Press or again to underscore OK. Press to continue.



This screen, Sensor Location, indicates the location of the sensor. If MV/P or other is selected, this is the location in which the sensor is connected via the SKIT 8821-4 adapter.

To select sensor location, press or and underscore MV/P or other, then press to select. Press or again to underscore OK. Press to continue. If other was selected, in the next screen specify which station number the sensor(s) is/are governed by.

**NOTE: If MV/P is selected on the screen, sensor must connect to the master valve wire or terminal. If other is selected, the sensor must be connected to one of the station's numbered terminals.**

If Other is selected, in this screen the sensor location must be specified (to which station number the sensor(s) is/are connected). Press or to underscore the digit number,

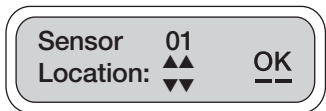

then press or to enter the station # that the sensor is connected to. Press or again to underscore OK. Press to continue

This screen, Sensor Governs, allows the user to designate the installed valves that will be governed by the sensor. To designate the valves that the sensor will control, press or and

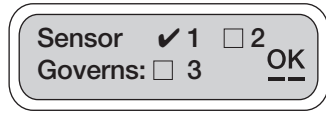

underscore the valve numbers to be governed by the sensor, then press to select, to deselect. Press or again to underscore OK. Press to continue.

**NOTE: If an installed switch type sensor is triggered, any valve that is check marked and is currently ON will complete its programmed run time. All further valve operations will be prevented until the sensor deactivates and allows watering again.**

The Change Password feature allows the user to change the default password (AAA) to any 3-digit combination of letters. To change the password, press or and underscore Yes

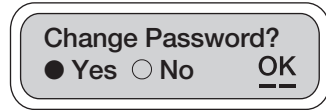

then, press to select. Press or again to underscore OK. Press to continue.

To enter a new password press or and underscore the first digit to be changed, then press or to change the letter. Repeat the steps for each letter then, press or

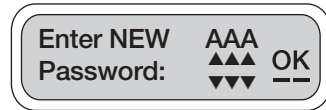

again to underscore OK. Press to continue.

When finished, write down the password so as not to forget it. Remember that a person who makes changes to the watering schedule or the setup, needs to re-enter the password each time they enter the controller.

## 5.8 SETUP RADIO (LEIT XRC only)

### Setting up for radio communication

\*Radio setup available only on model XRC.

The Setup Radio screens allow a LEIT XRC controller to be recognized by the LEIT Link handset. This is a one-time setup that can be updated if needed. In performing these steps, the user will select the controller to be in local or remote mode. If remote mode is selected, a controller Group ID (LEIT Link Master only), and a Controller ID will need to be assigned to be used for identification purposes when linking to a LEIT XRC controller via the handset. Due to the use of ambient light as a source of power, the user will need to limit the use of the radio to daylight hours only (8 AM-5 PM) to prevent power drainage from the controller.

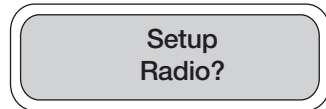

It is recommended to program the controller to operate in a window of early mornings to late afternoon.

Press to continue. Press or to quit or for help.

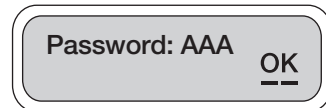







Passwords screen provide the user a security against unauthorized changes being made to the system. The Default

password is AAA. If the password has not been changed press to continue. If the password has been changed, enter the new password to continue. To enter the new password press or and underscore the digit to be changed, then press or to select the appropriate letter. Repeat the steps for each letter. When finished, press or to underscore OK. Press to continue.

This screen allows the user to select one of two modes, Local Mode or Remote Mode.

**Local Mode:** (default) The LEIT XRC controller is not listening to a signal from the LEIT Link handset and radio power is conserved.





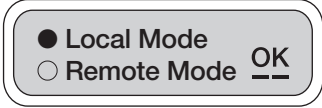

**Remote Mode:** Enables the LEIT XRC controller to scan for a signal from the LEIT Link handset. Select Remote Mode only when using the LEIT LINK handset

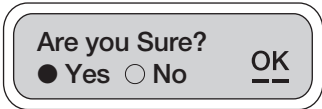
To select the mode, press  or  to underscore one of the two modes, then press  to select. Press  or  again to underscore OK. Press  to continue.









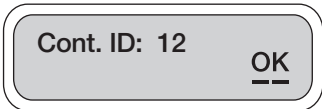

This is followed by the Are you Sure screen to confirm the option that has been selected.



Press  or  to underscore Yes or No, then press  to select. Press  or  again to underscore OK. Press  to continue.

The Controller ID is used as an individual identity address for a single controller and handset within a group of controllers. The Controller ID allows the user to link to a single controller, via the handset. On first contact, the Select ID screen displays two numbers that allow for a number from 1-99 to be entered as the controller's identity address. The user must enter the identity address into the controller.







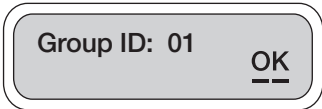

To set a controller ID, press  or  and underscore one of the ID numbers. Then press  or  to select the ID number. Repeat the steps with the second number to select a controller ID. Press  or  again to underscore OK. Press  to continue.

**NOTE: Do not change the group ID from 01 unless LEIT Link Master is used**

This option is available on the LEIT Link MASTER only.







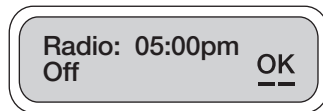
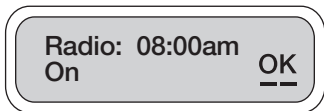

The Group ID Number allows the handset to link to a controller within a group of controllers, which have the same Group ID. This gives the user the flexibility to address an individual controller in a group of controllers by location or area.

Press  or  to underscore one of the two numbers then, press  to select a number. Repeat the steps with the second number to select the Group ID, then press  or  to underscore OK. Press  to continue.



In this screen the user can limit the controller radio operation time to daylight hours to prevent power drainage from the controller. Our suggestion is 8AM-5PM. This will allow the controller to operate in a window of early mornings to late afternoon.







**The LEIT XRC requires greater energy for radio communication. In order to retain sufficient energy to maintain valve control the radio on the controllers will automatically turn off in low light conditions.**

To set the Radio On, underscore the hour digits using  or  and press  or  to change the setting. Repeat the steps for changing the minute digit and AM/PM and when finished press  or  again to underscore OK. Repeat the steps for Radio Off. Press  to continue.











For your convenience 14 characters are available to set up location addresses, or any other descriptive text to remind you of the controller location when connecting via the LEIT Link handset (the text available is A-Z, 0-9 and \_).

NO DESCRIPTION  
ID12 Location OK

When setting addresses, OK is flashing. Underscore the first letter using  or  and press  to select the letter. Press  and the next digit will flush. Repeat the steps for changing each of the digits and when finished press  to underscore OK (this is the only screen where OK is flashing). Press  to continue.

The Client ID number allows a user to have a unique identity code for the LEIT XRC controllers and handsets. This is a security feature, which locks out unauthorized users (the permissible ID is any letter and number combination that follows this format: AAAA01-ZZZZZ99).

Client AAAA01  
Code: OK

Press  or  and underscore the first of the characters then, press  or  to select the character. Repeat the steps with each character that are changed. When finished, press  or  to underscore OK. Press  to confirm the setting. If the setting has been changed, the next step will remind you of the changes. Press  to continue.

Running In  
Remote Mode OK

This screen confirms the controller mode. Press  to continue.

Starting  
Remote Mode OK

**NOTE: If this screen is seen, it means the radio is not yet communicating. In this case, wait a few minutes and repeat the set up radio process..**

## 5.9 HELP

For customer support enter the help section and contact DIG at the telephone number listed

To enter Help press .

Press  to skip help and move to the next feature.

Press  to move to next screen.

Press  to continue.

HELP?

In USA  
800-322-9146 OK

Outside USA  
760-727-0914 OK

## 6. TROUBLESHOOTING

The LEIT irrigation control system is a series of connected components consisting of an ambient light powered controller, LEIT Key, LEMA actuators, hydraulic control valves, and field wires/splices. It is best to troubleshoot this DC system (like an AC system) by a process of elimination; the goal being to determine which component(s) has failed. The following facts and tips may be helpful to eliminate certain components and facilitate faster troubleshooting. It is assumed that these are installed controllers that are receiving the proper amount of light. Keep in mind that the problem may be with more than one component.

### 6.1 LEIT Key

1. Use only name brand, alkaline, 9-volt batteries
2. Weak batteries in a good LEIT Key will result in no display, or a CHARGING PLEASE WAIT MESSAGE.
3. If the LEIT key works in one LEIT controller but not another, the key is ok and the problem is with the controller.

4. If in doubt about the battery, install a new battery, or test the key with a multi-meter by holding the probes into the metal holes, voltage should be at least 8-volts DC.
5. The LEIT Key will work with all current and discontinued SOLATROL, ALTEC, and current LEIT controllers.

## 6.2 LEIT Controllers

1. If a "good" LEIT Key is inserted into a controller and there is no display, the problem is with the controller.
2. When a "good" LEIT Key is installed in a LEIT controller, "PRESS YES WHEN MOST READABLE" (English or Spanish) should appear on the display immediately.
3. If a LEIT Key is installed and the display reads "CHARGING PLEASE WAIT" the controller probably has a problem with the PVM or a radio enabled XRC is in shade.
4. If the LEIT controller is not holding the current day/time, the problem is with the controller.
5. If the display is scrambled or showing unrecognizable characters, the problem is with the controller.
6. If one or more of the keypad buttons are sticky or non-functional, the problem is with the controller.
7. To test a controller's output, connect a "good" LEMA 1600HE or 1520 actuator directly to the terminal strip, and initiate a temporary manual run with 1 minute to the station in question and zero minutes on all other stations. Verify that the plunger retracts and extends or you hear the sound of the plunger latching inside the solenoid. If it does not retract or make any sound, the problem is with the controller.
8. LEMA 1600 series actuators will not work on station #1 on LEIT 4000 controllers SW version 7.8 or less.
9. ALTEC Dash 4 or LEMA 1600 actuators cannot be used on expansion controllers.
10. If the controller functions properly doing a temporary manual run, but is not running valves automatically by program, the controller is probably incorrectly programmed. In SETUP SYSTEM check active programs, sensor & MV/P settings. In SETUP SCHEDULE, make sure no programs are overlap.
11. LEIT controllers will only function with LEMA actuators.
12. Compatible sensors are the HUNTER MINI-CLIK or RAIN BIRD RSD. The SKIT 8821-4 sensor adapter must be used with any sensor.

## 6.3 LEMA Solenoid Actuators

1. Verify that the proper model number solenoid actuator and series is being used for the controller in question.
2. Verify that the white wire is connected to the common wire, and the red wire is connected to the "hot" wire, and that these splices are tight, and corrosion free.

**NOTE: An ohm meter set to measure low resistance can be used for wiring verification. If the red and white wires are temporarily joined at the solenoid, the total loop resistance from the controller red to white should be less than 30 ohms.**

3. Verify that no water is leaking near the adapter, stem, or bonnet.
4. Verify that all "O" rings and/or rubber sleeves are in place. If in doubt, check manuals.
  - a. To test a LEMA actuator, remove the actuator from the valve and disconnect the hot and common wires. Verify the actuator functions with a 9-volt battery by holding the wires to the positive and negative contacts. Reverse polarity if nothing happens. Plunger should retract. Reverse polarity to close, (plunger should extend).
  - b. If a LEMA actuator does not function with a 9-volt battery, the problem is with the actuator, and it should be replaced.

**NOTE: Never use a high power source, such as a car battery to test a LEMA 1500 or 1600 solenoid actuator. If a 9-volt battery is used, never connect the solenoid for a long period, just briefly touch the wire. If applying power for more than half second, it can destroy the solenoid actuator.**

5. If the LEMA actuator works with the battery but not through the controller, remove the solenoid actuator from the valve and connect the LEMA actuator directly to the controller terminal strip and institute a temporary manual run. If it functions, the problem is with the field wires or the hydraulic valve.
6. If the valve is weeping or not closing completely the adapter may be loose, cross-threaded, missing an "O" ring, the adapter sleeve is damaged, or the valve diaphragm could be in need of cleaning or replacement.
7. If the valve is not opening completely, the adapter being used may be too tight, the adapter sleeve may be damaged, or the valve water passage down stream may be plugged and in need of cleaning.

The LEMA solenoid actuator operates only with 2-way normally closed valves.

8. Solenoid parts list.

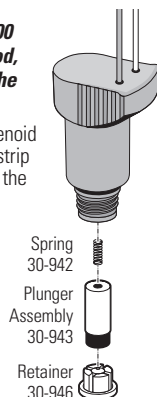

## 6.4 Hydraulic Valves

1. Verify that the valve opens and closes with the manual bleed. If it does not, the problem is with the valve (valve repair should be done by others).
  - a. Verify that the static mainline pressure at the valve is below 150 PSI and above 10 PSI.
  - b. Verify that the valve size is correct for the flow rate of the system.
  - c. LEMA actuators should be installed only on normally closed 2-way valves (check catalog or web-site for compatible models).

***For all brand name valves with internal manual bleed lever, make sure the lever is in closed position. Do not move the lever after installing the solenoid with the valve adapter. If the manual lever on the valve is used, it can damage the adapter or the sleeve causing the valve to stay open.***

## 6.5 Field Control Wires

1. Verify that the proper actuator series are being used for the controller in question.
2. Verify that the common wire (usually white) is connected to the common terminal and that the wire screw is tight.
3. Verify that all hot wires are in the proper terminals and the screws are tight.
4. Verify that all common and hot wire splices at the valves and splice boxes are tight and made with waterproof connectors.
5. 12 and 14 AWG direct burial single strand solid core irrigation wires are recommended, 18 AWG multi-strands are not.
6. Sometimes it may be prudent to run temporary wires above grade to the valve to verify a problem with the wire.
7. The latest LEIT X software can detect wire faults.
8. Wire problems are not the responsibility of DIG Corp.
9. If the same color hot wires are run to all valves, the wires should be identified and tagged with numbered stickers.

## 7. WARRANTY

DIG Corp. warrants to its customers who have purchased LEIT products, from an authorized DIG distributor, that its products will be free from original defects in material and workmanship for a period of three (3) years, from the date of original purchase. If any apparent defect arises under normal use and service in the LEIT product within the warranty period, DIG at its sole discretion, shall have the option to repair or replace part or all of the original product free of charge after return of such product at user expense, authorized in writing by DIG Corp. If a product is replaced, the replacement product will be covered for the remainder of the warranty period dating from the original purchase.

This warranty applies only to the DIG LEIT product line, which are installed as specified and used for irrigation purposes. This warranty applies only to products, which have not been altered, modified, damaged, misused or misapplied. This warranty does not cover products adversely affected by the system into which the products are incorporated, including improperly designed, installed, operated, or maintained systems. This warranty does not apply to blockage of solenoids due to use of water containing corrosive chemicals, electrolytes, sand, dirt, silt, rust, scale, algae, bacterial slime or other organic contaminants.

Tampering with a product (including, but not limited to attempting to disassembly) will void any warranty the product might otherwise be eligible for. In no event shall DIG's liability exceed the selling price of the product. DIG is not liable for consequential, incidental, indirect or special damages, including but not limited to the labor to inspect, remove or replace products, vegetation loss, loss of energy or water, cost of substitute equipment or services, property damage, loss of use or loss of profits; nor is DIG liable for economic losses, consequential damages or damage to property arising out of installer's negligence or based on strict liability in tort. The user and/or trade customer agrees to the limitations and exclusions of liability of this warranty by purchase or use of DIG products. . No representative, agent, distributor or other person has the authority to waive, alter, or add to the printed provisions of this warranty, or to make any representation of warranty not contained here.

Some states do not permit the exclusion or limitation of incidental or consequential damages or of implied warranties. Therefore, some of the above exclusions or limitations may not apply to you.

This warranty on LEIT products is given expressly and in place of all other expressed or implied warranties of merchantability and fitness for particular purpose, and this warranty is the only warranty on LEIT products line made by DIG Corp.

# 8. LEIT CONTROL PROGRAMMING QUICK REFERENCE CHART

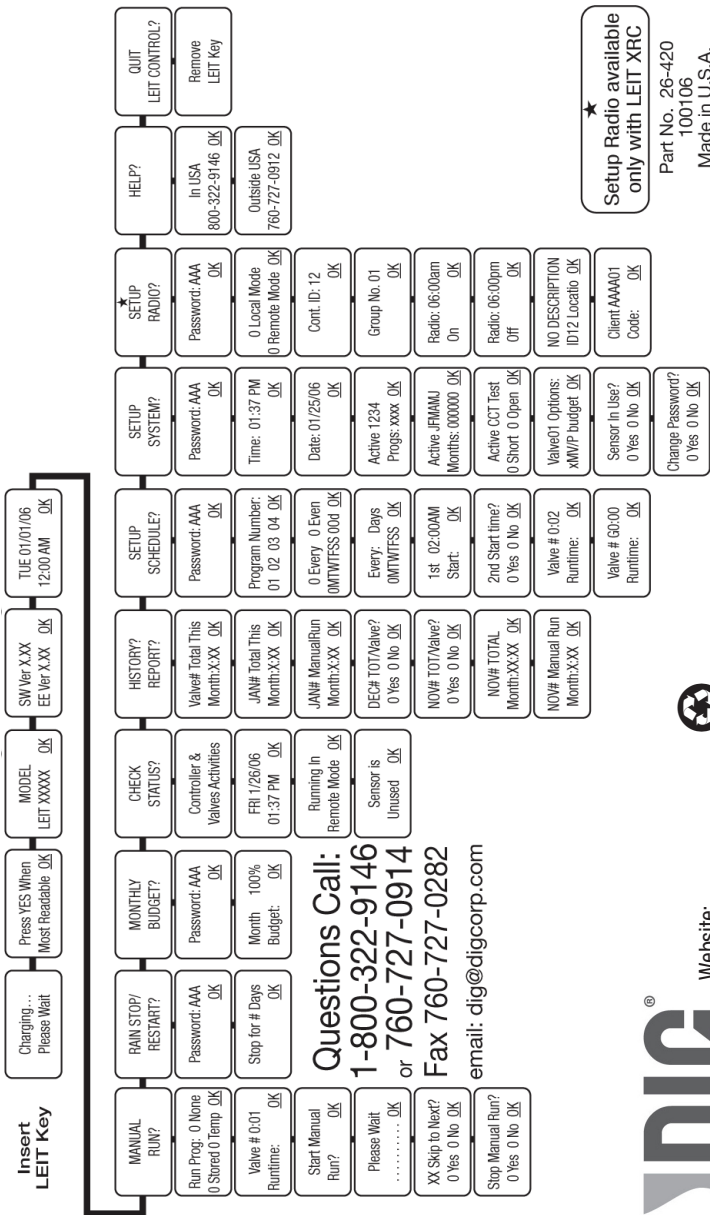

**Questions Call:**  
**1-800-322-9146**  
 or **760-727-0914**  
**Fax 760-727-0282**  
 email: [dig@digcorp.com](mailto:dig@digcorp.com)



Website:  
[www.digcorp.com](http://www.digcorp.com)  
 e-mail: [dig@digcorp.com](mailto:dig@digcorp.com)  
 012110 DIG CORP 26-409  
 Printed in the USA  
 DIG is a Registered Service Mark of DIG Corp.

1210 Activity Drive  
 Vista, CA 92083, USA

★ Setup Radio available only with LEIT XRC

Part No. 26-420  
 100106  
 Made in U.S.A.