



SmartTest

HLT 550

HLT 560

HLT 570

Operating Instructions

Product identification

The data specified on the rating plate are necessary in correspondence with Pfeiffer Vacuum. Therefore transfer the data to the copy.



Fig. 0-1

Validity

This document is valid for products with the article number

SmartTest

PT L02 100 (HLT 560, 230 V~, with rotary vane pump UNO 005 A)

PT L02 101 (HLT 560, 120 V~, with rotary vane pump UNO 005 A)

PT L02 102 (HLT 560, 100 V~, with rotary vane pump UNO 005 A)

SmartTest

PT L02 120 (HLT 550, 100 ... 230 V~, with backing pump provided by the customer)

SmartTest

PT L02 110 (HLT 570, 230 V~, with diaphragm pump MVP 035)

PT L02 111 (HLT 570, 120 V~, with diaphragm pump MVP 035)

PT L02 112 (HLT 570, 100 V~, with diaphragm pump MVP 035)

This document is based on firmware versions beginning with V2.3.

If the instrument does not work as described, check whether your instrument is equipped with these firmware versions.

Subject to technical modifications without prior notice. The figures are not to scale.

Content

1	Safety	7
1.1	Directions for Use	7
1.1.1	Use of this Manual	7
1.1.2	Symbols Used	7
1.2	General Safety Precautions	8
1.2.1	Use for the Intended Purpose	8
1.2.2	Responsibility and Guarantee	10
1.2.3	Personnel	10
1.2.4	General Safety Rules	11
1.3	Scope of Delivery	14
2	Technical Data	15
2.1	General	15
2.2	Mains Connection	15
2.3	Environmental Data	15
2.4	Measure	16
2.5	Interfaces	17
2.6	Backing Pumps	17
2.7	Turbo Pump	18
3	Description	19
3.1	Measuring System	20
3.2	Detection Principles	21
3.3	Leak Detection Methods	22
3.4	Test Gases	24
3.5	Background Suppression	25
4	Manual Control Elements	29
4.1	Instrument Operation	29
5	Commissioning	30
5.1	Installation, Assembly	30
5.1.1	Unpacking	30
5.1.2	Carrying / Transport	30
5.1.3	Transport Lock	31
5.2	Mount the External Backing Pump	31
5.3	Mounting Accessories	32
5.3.1	Sniffing Probe	32
5.3.2	Remote Control	32
5.3.3	Bypass Option	33
5.3.4	Signal tower	33
5.3.5	Exhaust pipe	33
5.3.6	Venting Line	33
5.4	Mains Connection	33
6	Operation	35
6.1	Switching On and Off	35
6.2	Ready to start	39
6.2.1	Regeneration	40
6.2.2	Check internal test leak	40
6.2.3	Setup	40

6.2.4	Calibration	41
6.2.5	Measuring mode Vacuum / Sniffing	41
6.3	Measure	43
6.3.1	Measure with a test item	43
6.3.1.1	Vacuum mode	43
6.3.1.2	Sniffing mode	43
6.3.2	Measured Value Display	44
6.3.3	Display Range Settings	45
6.3.4	Volume	45
6.4	Setup	46
6.4.1	View	46
6.4.1.1	Contrast	47
6.4.1.2	Units	48
6.4.1.3	Time & Date	49
6.4.1.4	Display Range	49
6.4.1.5	Lower Display Limit	50
6.4.1.6	Background at "Ready to Start"	51
6.4.2	Access Control	51
6.4.2.1	Change Menu-PIN	52
6.4.2.2	Change Device PIN	53
6.4.2.3	Calibration Enabled	54
6.4.2.4	Maintenance enabled	55
6.4.3	Language	56
6.4.4	User Settings	56
6.4.4.1	Mode & Mass	57
6.4.4.2	Filter & Zero	59
6.4.4.3	Alarm	61
6.4.4.4	Interfaces	62
6.4.4.4.1	Analog Output	63
6.4.4.4.2	Compact Gauge	65
6.4.4.4.3	Control Location	66
6.4.4.4.4	Relay	67
6.4.4.4.5	Serial Port	68
6.4.4.4.6	Bypass Option	69
6.4.4.5	Parameter save / load	70
6.4.4.5.1	Load PARA Set 1 / 2	70
6.4.4.5.2	Load Factory Settings	71
6.4.4.5.3	Save PARA Set 1 / 2	71
6.4.4.6	Monitoring functions	72
6.4.4.6.1	Flow	72
6.4.4.6.2	Contamination Protection	73
6.4.4.6.3	Volume & Beep	74
6.4.4.6.4	Valves	75
6.4.4.6.5	Evacuation Time & Vent	76
6.4.4.6.6	Calibration Request	78
6.4.5	Calibration Settings	79
6.4.6	Information	80
6.4.6.1	Settings	80
6.4.6.2	System Data	81
6.4.6.3	Vacuum System	81
6.4.6.4	Error List	82
6.4.6.5	Calibration History	82
6.4.6.6	Paging function remote control RC 500 WL	83
6.4.7	Maintenance and Service	84
6.4.7.1	Maintenance device	84
6.4.7.2	Burn In	85
6.4.7.3	Maintenance Interval Components	86

6.4.7.4	Maintenance List	86
6.4.7.5	Service	87
6.5	Calibration Vacuum Method	88
6.6	Calibration Sniffing Method	92
6.7	Measuring the Internal Test Leak	95
<hr/>		
7	Errors	97
7.1	Malfunction Messages	97
7.2	Warnings	101
7.3	Changing Mains Fuses	105
<hr/>		
8	Disposal	107
<hr/>		
9	Accessories and Consumer Materials	108
<hr/>		
	Appendix	110
A	Remote Control RC 500 WL	110
B	Interfaces	111
C	List of Default Values	117
D	Pirani-Characteristic	119
E	List of literature	120
F	Declaration of Contamination	120
G	Declaration of Conformity	121

1 Safety

1.1 Directions for Use

1.1.1 Use of this Manual

This chapter describes the safety requirements which must be observed on all accounts when using the SmartTest Helium Leak Detector.

All persons working on and with the leak detector must have read and understood the chapters relevant to their activities. This chapter is binding for all persons and all activities.

1.1.2 Symbols Used

The following symbols are used with explanatory text to alert people to remaining risks during use for the intended purpose and to stress important technical requirements.



Danger

Specifications for the prevention of bodily injuries of all kinds



Warning

Specifications for the prevention of severe material and environmental damage



Note

Specifications for handling or use. Failure to observe these can lead to faults or minor material damage.

1.2 General Safety Precautions

1.2.1 Use for the Intended Purpose

The SmartTest Helium Leak Detectors serve for measurement and localization of small and very small leaks both on components and modules and on fittings and systems. They are suitable both for underpressure leak testing (vacuum method with or without partial current operation) and for overpressure leak testing (sniffing method).

The SmartTest Helium Leak Detectors may only be used for leak testing for the gases specified in the "Technical Data".

The SmartTest Helium Leak Detectors are designed specially for industrial applications and are used:

- For quality control in manufacturing processes,
- for quality control of production plants,
- as a service unit.

Use for the intended purpose also includes:

- Use of standard and original accessories,
- observance of this document and compliance with the instructions and regulations therein.



Danger

Risk of injury due to toxic, flammable and corrosive gases!

Harmful substances, which are pumped down with the SmartTest (Vacuum Mode, Sniffer Mode), emit through the exhaust and injure people in the surrounding area. Do not sniff and pump down harmful substances.



Danger

Risk of injury due to gliding off and falling.

Do not climb on the SmartTest.



Danger

The SmartTest may tip off its base and injure people.

Place the SmartTest on a stable base.



Danger

Risk of injury due to sucking connection flange.

If the Vacuum-Mode of the SmartTest is activated, the connection flange may suck bodily parts around the connection flange.

Keep bodily parts off the connection flange.



Warning

The Helium Leak Detector SmartTest may not be operated in standing or under flowing or dripping water. The same applies for all other kinds of liquids. Avoid contact of the SmartTest with bases, acids and solvents as well as extreme climatic conditions.

No corrosive process gases may be pumped with the SmartTest. Failure to observe this will lead to voiding of the guarantee.



Warning

The leak detector must not directly be switched off after the process, in which condensable gases or steams are pumped, is finished. It must be running (at least 20 minutes) with opened gas ballast valve until the oil of the pump is freed from detached steams.

If this instruction is not respected, the pump can be damaged by corrosion effects.

The oil level of the pump has to be controlled regularly.

The normal intervals of changing the oil from the producer have to be taken care of. See instructions of the rotary vane pump.



Warning

The vacuum pump, vacuum system and sealings may be damaged.

Do not generate overpressure with the SmartTest.

Do only use the SmartTest for leak detection.



Warning

The SmartTest may be damaged by misapplying it as step tread.

Do not use the SmartTest as step tread.



Warning

The SmartTest may be damaged by misapplying it as seat.

Do not use the SmartTest as seat.



Warning

The coating of the filament in the ion source may be damaged.

A burnout of the filament is possible.

Do not pump down those gases with the SmartTest, which contain halogen molecules (e.g. flour, chlorine).

Such gases are e.g.: SF₆



Note

Caution: Danger of injury

Although this instrument is distinguished by high standards of quality and safety and has been built and tested according to the latest state of the art, injury or material damages cannot be totally ruled out in the event of misuse or use for a purpose which was not intended.

Therefore read this document carefully and especially observe the "Safety" chapter. Keep this document close to the instrument at all times.



Note

The SmartTest may be damaged by wrong handling.

Do only run the SmartTest under the allowed conditions of temperature (+10° C to +35° C) and relative humidity (max. 80% up to +31° C, decreasing to 50% at +35° C). (See also chapter 2.3)



Note

The SmartTest may be damaged due to lack of inspections.

In order to prevent subsequent damages, check the exterior of the SmartTest frequently relating to optical damages, and follow the Maintenance Instructions frequently.

1.2.2 Responsibility and Guarantee

Pfeiffer Vacuum will accept no responsibility and provide no guarantee and exclude itself from all liability in the event that the user or third parties

- use the product for a purpose for which it was not intended,
- fail to observe the "Technical Data",
- manipulate the product in any way (conversions, modifications, etc.),
- operate the product with accessories which are not listed in the appropriate product documentation.

1.2.3 Personnel

Operating personnel

The operating personnel may operate the SmartTest leak detector in normal operation. The normal operation includes **only** the following activities:

- Operation,
- the care and maintenance work described in this document.

Maintenance personnel

The maintenance personnel may operate the SmartTest leak detector in normal operation and perform maintenance work necessary for trouble-free operation of the instrument.

In order to be authorised to maintain the SmartTest leak detector, the person concerned must have taken part in an initial training conducted by a Pfeiffer Vacuum employee or an experienced member of staff of the system user. (See Maintenance Instructions IG 0108 BEN for further information.)

Service personnel

The service personnel may operate the SmartTest leak detector in normal operation and perform maintenance and service work.

The SmartTest leak detector may be serviced **only** by trained Pfeiffer Vacuum staff or trained employees of the system user with a similar qualification.

Training as a master electrician or a similar professional training is necessary in order to work on the electrical components.

See Maintenance Instructions IG 0108 BEN for further information.

1.2.4 General Safety Rules

Legal regulations

The generally applicable legal and otherwise binding regulations for the prevention of accidents and protection of the environment must be observed in addition to this document.

Such regulations may also extend to the handling of hazardous substances or provision/wearing of personal safety equipment etc. for example.

Probable risk

On suspicion that safe operation is no longer possible, the instrument must be taken out of operation and secured against accidental starting.

This may be the case:

- when the device shows visible signs of damage
- when liquid has penetrated the instrument
- when the instrument is no longer working
- after long periods of storage under adverse conditions
- after great transport stress

Energy connections, protective earthing

Make sure the instrument is suitable for operating on the local power supply before connecting it.

The mains plug may only be plugged into a shockproof socket



Danger

Caution: Mains voltage

Improperly earthed products may be dangerous to life in the event of a malfunction.

Connect the product in accordance with local regulations and earth correctly. Interruption of the earthed conductor inside or outside the instrument is not permissible.

Installation of protective devices

An exhaust pipe must be installed under certain circumstances.

See Chapter [5.1.2](#).

Misuse of protective devices

Only fuses of the specified type with the specified current rating may be used as replacements.

Opening the instrument



Danger

Caution: Mains voltage, hot parts and rotating components

Removal of the housing shells is dangerous to life and limb.

The housing shells may never be removed in the course of the work described in this document.

Sending in for repairs



Warning

Products returned to Pfeiffer Vacuum for service or repair must be free of harmful substances (e.g. radioactive, toxic, caustic or microbiological).

Forwarding contaminated products:

- Adhere to the forwarding regulations of all involved countries and forwarder companies.
- Enclose a completed Declaration of Contamination.
- Declare all dangers on the package.

Products which are not clearly declared as "free from potentially harmful substances" will be decontaminated at the expense of the customer.

A completed and signed "Contamination Declaration"
(see: www.pfeiffer-vacuum.net and appendix [Declaration of Contamination](#)) must
be enclosed with every product sent in for repair.

Spare parts

Only original spare parts may be used for repairs. See maintenance Instructions
IG 0108 BEN.

1.3 Scope of Delivery

The scope of delivery includes the following parts:

- Basic device HLT 5xx
- Power-Subcon; relay plug
- Cap for Power-Subcon; relay plug
- Connecting plug: Ventilation sniffer connection
- Filter mat fan 500 µm
- Power cable
- Set of hexagonal wrenches
- Set of fuses
- Documentation

2 Technical Data

2.1 General

Dimensions	550×460×304 mm (L×W×H)
Weight	44 kg HLT 560, HLT 570 34 kg HLT 550 approx. 150 kg HLT 565/572/575 with carriage and pump
Max. permissible acceleration in operation	1 G (horizontal)
Test connection	DN 25 ISO-KF
Cooling air	
Inlet	Bottom, with dust filter
Outlet	Side
Exhaust gas connection	For hose ø8/6 mm
External backing pump connection	DN 25 ISO-KF
Venting connection (N ₂)	Sniffing line connection for hose ø6/4 mm
Maximum pressure at the venting connection	1.1 bar
Standards and regulations	Declaration of Conformity (Appendix)
Degree of protection	IP 40
Degree of contamination	2 (EN 61010)

2.2 Mains Connection

Voltage / frequency	230 V ±10% / 50 Hz 120 V ±10% / 60 Hz 100 V ±10% / 50/60 Hz
Protection class	1
Overvoltage category	II
Current	<10 A
Power consumption	<400 VA (HLT 560) <150 VA (HLT 550) <300 VA (HLT 570)
Fuses	2 pieces, 10.0 A slow blow, 250 V, ø5×20 mm

2.3 Environmental Data

Temperature

Storage	-10 °C ... +55 °C
Operation	+10 °C ... +35 °C
Relative humidity	max. 80% up to +31 °C, decreasing to 50% at +35 °C
Use	Only indoors, altitude up to 2000 m above sea level
Noise level	<70 dB/A (according to IEC standard)

2.4 Measure

Operating modi	Vacuum / sniffing
Operation standby	≤3 minutes (runup time pump)
Inlet pressure	≤18 mbar (temporarily up to 25 mbar)
Filaments	2 (Iridium yttrated)
Filter stages	none, static dynamic
Measuring rate	20 Hz
Display rate	3 Hz
Alarm	
Acoustics / Volume	adjustable
Threshold value / Pre-warning	adjustable
Relay output	adjustable
On-screen displays	Leak rate vs. time, analogue / digital

Vacuum mode

Smallest detectable leak rate	according to AVS 2.1
⁴ He,	<5×10 ⁻¹² mbar l/s
³ He	<5×10 ⁻¹⁰ mbar l/s
H ₂	<5×10 ⁻⁸ mbar l/s
Greatest detectable leak rate	
⁴ He,	1 mbar l/s
H ₂ , ³ He	1×10 ⁻² mbar l/s
Measuring range	10 ⁻¹² ... 1 mbar l/s
Dimensional units of the display	mbar l/s, Pa m ³ /s, sccm, sccs Torr*l/s, atmcc/s
Detectable gases	⁴ He, ³ He, H ₂
Response time (to 63% of the signal)	<0.3 s
Suction rate for helium	>2.5 l/s at p _{inlet} < 0.5 mbar
Suction rate at inlet with large backing pump (on HLT 550)	depending on the external pump
Pump time for high sensitivity	

at volume 0.5 l	2 s (HLT 560, HLT 570)
at volume 10 l	70 s (HLT 560)
	200 s (HLT 570)
at volume 100 l	700 s (HLT 560)
	2100 s (HLT 570)

Pump time up to first measurement

at volume 0.5 l	2 s (HLT 560, HLT 570)
at volume 10 l	45 s (HLT 560)
	135 s (HLT 570)
at volume 100 l	500 s (HLT 560)
	1300 s (HLT 570)

Internal test leak

→ Rear of the instrument

Sniffing mode

Smallest detectable leak rate
⁴He, ³He, H₂

according to AVS 2.1
<5×10⁻⁸ mbar l/s

Greatest detectable leak rate

⁴He,
H₂, ³He

1 mbar l/s
1×10⁻² mbar l/s

Measuring range

1×10⁻⁸ ... 1 mbar l/s

Dimensional units of the display

mbar l/s, Pa m³/s, ppm, sccm, sccs, g/a, oz/yr, Torr*l/s, atmcc/s

Detectable gases

⁴He, ³He, H₂

Response time

<1 s with 3 m sniffing line

2.5 Interfaces

Connecting plug arrangement and detailed data, see Communication Protocol IG 0105 BEN.

2.6 Backing Pumps

HLT 550

To be provided by the customer

HLT 560

Pfeiffer Vacuum UNO 005 A

Single-stage rotary vane pump, oil sealed

Volume flow rate

4 m³/h at 50 Hz, 5 m³/h at 60 Hz

HLT570

Pfeiffer Vacuum MVP 035
Volume flow rate

Two-stage diaphragm pump, oil-free
2 m³/h

2.7 Turbo Pump

Pfeiffer Vacuum SplitFlow 80
Volume flow rate for N₂

Turbo pump with interstage pumping
60 l/s

3 Description

The SmartTest Helium Leak Detectors are microprocessor-controller leak detecting instruments. All the processes in the instrument are controlled automatically.



Fig. 3-1

- 1** Test connection
KF25 connection for connecting test objects
- 2** Rear
Rear with mains connection, interfaces, connection for remote control, sniffing probe and venting
- 3** Instrument operation
Display and control unit
- 4** Loudspeaker
Housing opening for loudspeaker signals
- 5** Fresh air opening
Opening in housing for fresh air supply
- 6** Exhaust air opening
Opening in housing for exhaust air discharge

Extension stages

Depending on the application the basic SmartTest instrument is extended with:

- an external backing pump
- a carriage

See Operating Instructions Helium Leak detector SmartTest with Cart.

3.1 Measuring System

The measuring system consists (simplified) of:

- a test connection
- a backing pump
- a turbo pump
- a few valves
- a helium sensor

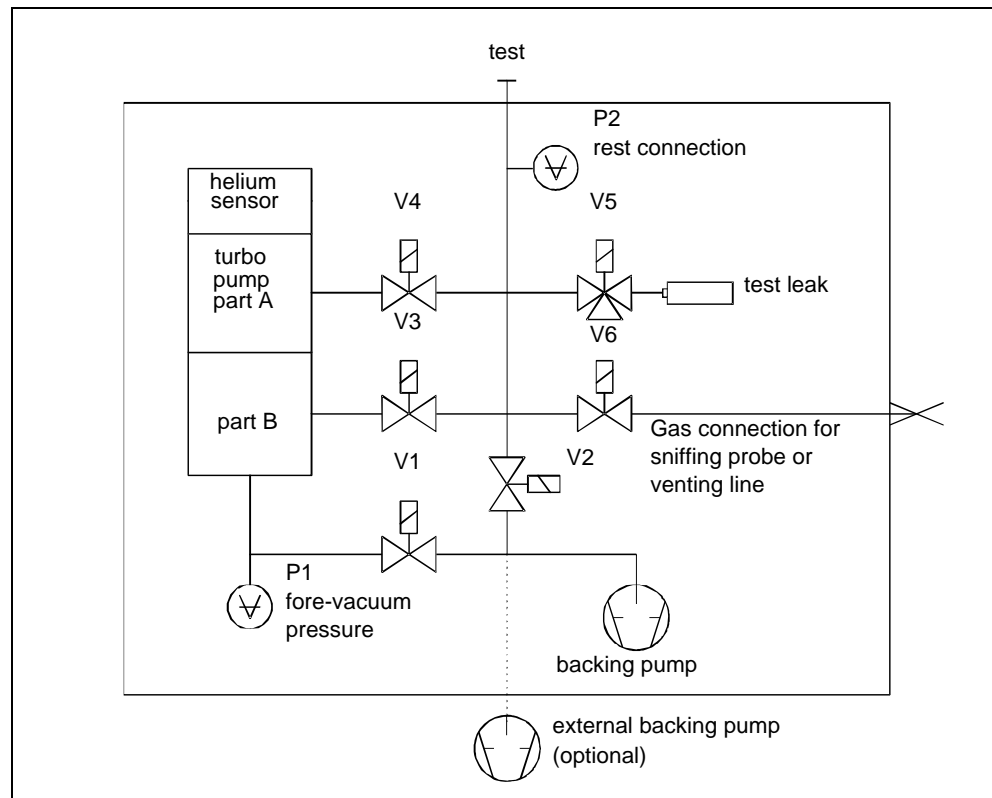

Fig. 3-2

The sample is flanged to the test connection. The valves V1, V2, V3 and V4 connect the sample and the helium sensor without an unsuitable operating state occurring for this.

A test leak is connected with valve V5 for calibration.

The valve V6 serves for venting so that the sample can be removed again. It is also used as a sniffing connection.

All valves open electromagnetically and close with spring force.

The measuring tube P1 measures the fore-vacuum pressure, P2 the pressure at the test connection.

3.2 Detection Principles

Counterflow

The sample is connected to the backing pump via valve V2. At a pressure $p_2 \leq 15 \text{ mbar}^*)$ the valve V1 to the turbo pump is opened. Helium can get to the helium sensor through the two partial pumps A and B against the pumping direction. The mass-dependent compression capacity of the two partial pumps keeps away heavy gases. The proportion of helium which gets through to the helium sensor depends on the suction performance of the backing pump and the compressions of the two partial pumps.

Twin-Flow™

The gas flow from the sample goes through the test connection.

Twin-Flow™ low: At pressure $p_2 < 5 \text{ mbar}^*)$ V1 and V3 are open

Twin-Flow™ high: At pressure $p_2 < 0.5 \text{ mbar}^*)$ V1 and V4 are open

The gas flow passes through partial pump B to the backing pump and the test connection is pumped up to high vacuum. The suction performance of the partial pump B is approx. 40 l/s. Only the partial pump A acts in counterflow and allows light gasses such as hydrogen and helium to get through to the helium sensor on account of the mass-dependent compression capacity.

3.3 Leak Detection Methods

When searching for leaks with the SmartTest the test gas entering or escaping through leaks in the sample is detected.

For gas to flow through a leak a pressure difference between the inside and outside of the sample is necessary. For this either excess pressure or vacuum pressure is generated inside the sample.

Vacuum method

In the vacuum method test gas is blown against the wall of the evacuated sample from the atmosphere side. It enters the sample at leaks and is fed to the leak detector.

The sample must be vacuum pressure-proof.

The sensitivity stages

counterflow ⇒ Twin-Flow™ low ⇒ Twin-Flow™ high

are run through.

The detection limit is lower than in the sniffing method. The helium concentration at the leak must be known in order to quantify the leak. The state of equilibrium must be waited for.

* Factory settings. Other valve settings. See Chapter [6.4.4.6.4](#).

Sniffing method

In the sniffing method the test gas escaping from leaks in the sample into the atmosphere is detected.

The sample must withstand the applied test pressure.

In operation with the sniffing probe a constant gas flow is sucked in from the atmosphere. The helium proportion of the air (5.2 ppm) causes a leak rate display of approx. 1×10^{-6} mbar l/s which can be eliminated by the ZERO function.

To detect a leak, the sniffing probe is applied to the points of the sample under helium overpressure which are suspected of leaking. An increased leak rate value indicates an increased concentration of helium and therefore a leak. The higher the pressure and the helium concentration in the sample, the smaller the leaks which can be detected.

The sensitivity stages

counterflow \Rightarrow Twin-Flow™ low

are run through.

The detection sensitivity and the quantifiability of the leak rate are less favourable than in the vacuum pressure leak detection.

3.4 Test Gases

For reasons of economy and detection sensitivity ^4He (helium with mass 4) is generally used as a test gas for leak detection. Under certain conditions, e.g. at increased ^4He concentration on the sample, it may be useful to change to a different test gas such as ^3He (helium with mass 3) or H_2 (hydrogen, mass 2). These gases can also be detected with the leak detector.



Danger

Caution: Danger of explosion

Hydrogen forms a highly explosive gas mixture with air.

Great caution is necessary when using hydrogen! No smoking, no naked flames, avoid sparks.



Note

Because of the high percentage of water in typical residual gases, the leak rate background in the measurement of hydrogen is fairly high (in a range from 10^{-7} mbar l/s).

For the leak detection the test gas can be diluted with a neutral gas such as nitrogen or argon. This helps to reduce contamination of the atmosphere and an increase in the signal background especially in case of serious leaks. The leak rate signal is then of course reduced according to the test gas concentration.

3.5 Background Suppression

The background signal may increase dependent on the measuring conditions (e.g. high percentage of helium in the ambient air).

The background signal can be suppressed to enable easy measurement of small leak rates despite a high background.

The background suppression can be locked or activated automatically with every START. See Chapter 6.4.4.2.

Rising background

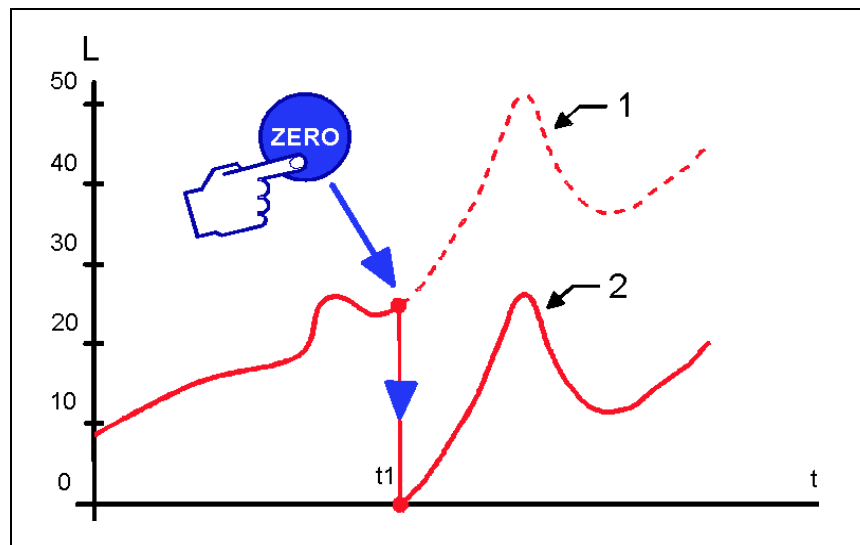

Fig. 3-3 Rising background

Item Description

- 1 raw signal
- 2 displayed leak rate

By pressing the "ZERO" key the momentary raw signal (e.g. at time t1) is saved as a background value and is then subtracted from the following measured values. See Chapter 6.4.4.2.

The status message Zero appears in the measured value display.

Falling background

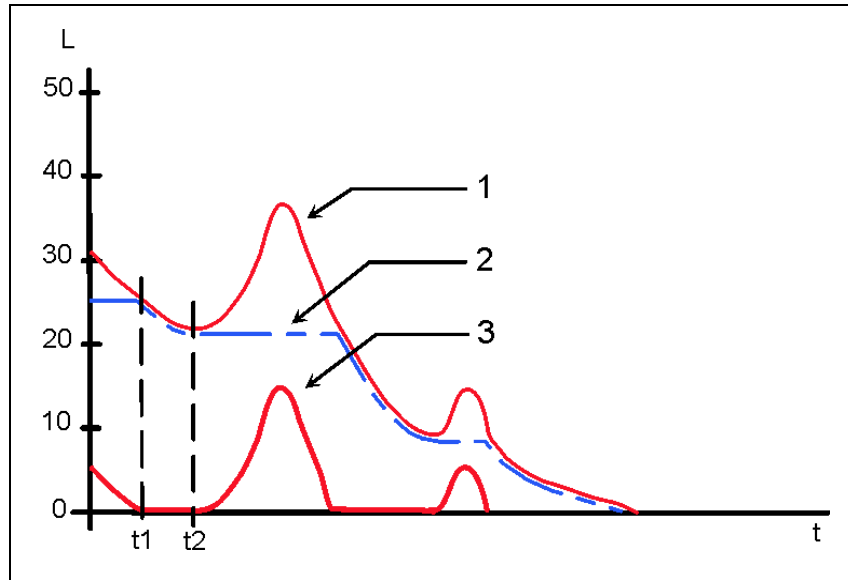

Fig. 3-4 Falling background

Item Description

- 1 raw signal
- 2 saved value
- 3 displayed leak rate

If the raw signal falls below the saved background value this is automatically set equal to the raw signal (e.g. at time t1). As soon as the raw signal rises again (e.g. at time t2), the saved background value remains constant. Signal increases are displayed clearly as a leak.

This greatly simplifies measurement of the smallest leak rates.

Absolute measurement

If you want to see the raw signal (including background), press the ZERO key for about 3 s.

The saved value is set to zero (e.g. at time t3), the background signal is no longer suppressed.

Item Description

- 1 displayed leak rate
- 2 raw signal

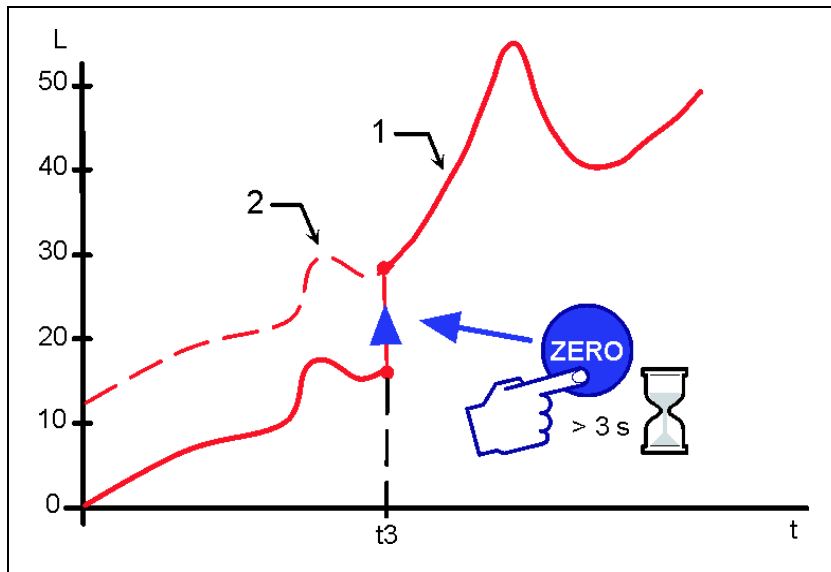

Fig. 3-5 Absolute measurement

Zero constant function

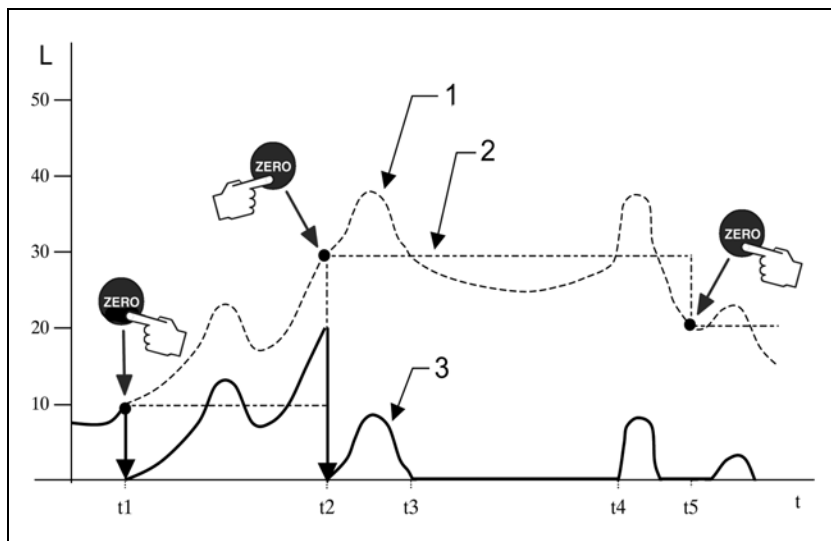

Fig. 3-6 Zero constant function

Item Description

- 1 raw signal
- 2 saved value
- 3 displayed leak rate

By pressing the "ZERO" key the momentary raw signal (e.g. at time t_1 , t_2 , t_5) is saved as a background value and is then subtracted from the following measured values/raw signals.

The status message Zero appears in the measured value display.

The automatic background suppression is locked. The zero value is retained after pressing the Stop key. Pressing the Zero key again overwrites the zero value. The zero value is set to "0" at Power Off or changing the zero function.

If the raw signal of the leak rate drops below the saved value/background value (see time: t3 to t4), it is not evaluated but the slightest detectable leak rate/detection limit is displayed.

So leaks are not displayed (raw signal) that are smaller than the saved underground value (saved value).

4 Manual Control Elements

4.1 Instrument Operation

The operating unit is the display, operation and control unit for the leak detector.

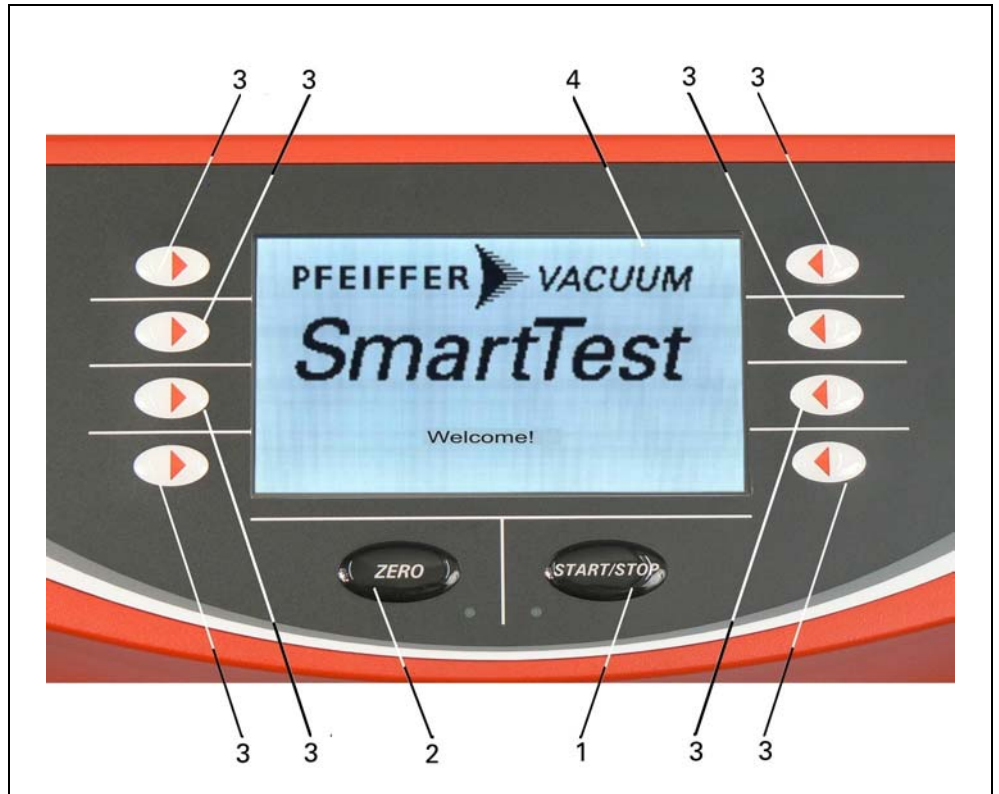

Fig. 4-1 Functions of the buttons on the display

- 1** START/STOP key
The measuring process is started and stopped with the START/STOP key.
- 2** ZERO key
ZERO activates the background suppression in measurement mode. When you press the key longer than 3 seconds you will deactivate the underground pressure.
- 3** Softkeys
The function of these keys depends on the current operating state. The respective meaning appears in the display.
- 4** Display
The display shows measured values, operating modi, instrument parameters and their values as well as the meaning of the softkeys.

5 Commissioning

5.1 Installation, Assembly



Note

See the Chapter "Technical Data" (Chapter 2) regarding the permissible ambient temperature, degree of protection, voltages, max. acceleration of the instrument in operation etc.

Despite good attenuation and vibration decoupling of the mechanical pumps in the SmartTest, vibrations of the instruments can never be ruled out totally.

To avoid humming (vibration of the instrument on a base with a similar resonance frequency) a firm, stable base should be chosen which only exhibits a slight tendency to vibrate.

5.1.1 Unpacking

The leak detector is delivered in a special packing ready for operation.



Note

The packing must be checked for damage before unpacking. If damage to the packing or the instrument itself is visible, please file a damage report with the shipping agent responsible immediately.

We recommend you to keep the special packing. This original packing offers the best protection for transport over a great distance or for returning the leak detector for servicing.

5.1.2 Carrying / Transport



Note

Only applies for type HLT560.

The pump (with oil filling) may be tilted by a maximum of 90°. In operation by a maximum 10°.



Danger

Caution: Heavy product

When carrying heavy items your back can be injured or other injuries can occur when the item slips out of your hands.

Two people should carry the product.

There are recesses for the hands on both sides for carrying and transporting the SmartTest, see Fig. 5-1.



Fig. 5-1 Position to held the SmartTest

The centre of gravity is towards the rear of the unit, therefore it must be held near the back.

5.1.3 Transport Lock

If your SmartTest (HLT570) has a label "Transport locking" on the base, please remove the two Allan head screws (size 4) at the label.

Keep the screws.

The screws must be reinserted for transport.

5.2 Mount the External Backing Pump

SmartTest HLT 550

The external backing pump is connected at the bottom via the connection flange DN 25 ISO-KF.

Other SmartTest models

If large volume objects need to be tested, an additional backing pump can be connected at the bottom via the additional connection flange DN 25 ISO-KF. See Chapter 9.

5.3 Mounting Accessories

5.3.1 Sniffing Probe

Connect the sniffing probe as illustrated for sniffing operation.



Fig. 5-2 Connections for sniffing probe

- 1** Input / output connection
- 2** RC connection
- 3** Electrical connection for sniffing probe
- 4** Gas connection for sniffing probe or venting line (hose nipple \varnothing 6/4 mm)
- 5** Exhaust gas connection ($1/4$ " quick screw connection for hose \varnothing 8/6 mm)



Note

The sniffing probe must be removed for vacuum operation because the connection is used for venting.

5.3.2 Remote Control

Connect the optional Remote control unit to connection 2 (RC). See also Appendix.

5.3.3 Bypass Option

Connect the 25 poles D-sub connector of the bypass option to connection 1 (Input / Output). See also Operating Instructions.

5.3.4 Signal tower

Connect the 25 poles D-sub connector of the signal tower to connection 1 (Input / Output). See also Operating Instructions.

5.3.5 Exhaust pipe



Danger

Caution: Exhaust gases and fumes

Exhaust gases and fumes from oil-sealed pumps may be harmful to health.

For operation in poorly ventilated rooms, an exhaust pipe should be connected to exhaust connection 5 depending on the application and gases used.

In the HLT 560 oil fumes may occur after prolonged pumping against a high pressure caused by the oil-sealed pump used.

5.3.6 Venting Line

For venting the samples with a certain gas – e.g. argon or dry nitrogen – this can be connected to connection 4.

The excess pressure at the venting connection may not exceed 0.1 bar.

5.4 Mains Connection



Danger

Mains voltage

Improperly earthed products may be dangerous to life in the event of a malfunction.

Only a 3-pole power cable with a properly connected protective earth may be used. Only plug the mains plug into a shockproof socket. The protective effect may not be cancelled out by an extension cable without an earthed conductor.



Note

Connection data

Before connecting, make sure that the operating voltage of the instrument matches the local mains voltage. You will find the specifications on the rating plate on the back of the instrument.

6 Operation

6.1 Switching On and Off

Check the correct installation of all cables and accessories and compliance with the "Technical Data".

The mains switch is on the back of the housing.

Switch on the instrument.

The instrument can be switched off at any time and in any state. The current settings will be saved.



Fig. 6-1

- 1** Mains switch
Serves to switch the instrument on and off.

Warning

Caution: Abrupt movements

Abrupt movements can damage the running turbo pump.

Avoid abrupt movement and vibration of the instrument (e.g. running over cables, door sills) during operation and up to 4 minutes after switching off since the turbo pump can be damaged.

The instrument designation is displayed after switching on – the instrument runs a self-test.

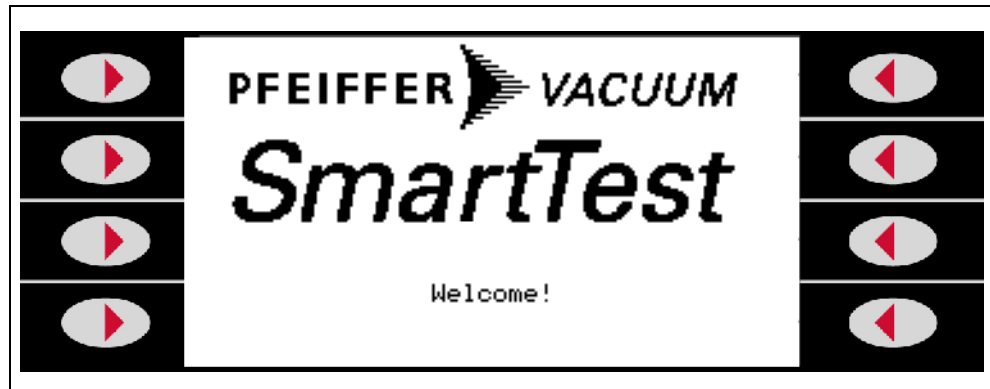



Fig. 6-2 Display SmartTest

After the self-test, the message "Pfeiffer-Vacuum; SmartTest" is displayed.

 **Note**

For the most accurate measurements or for calibration, the SmartTest should be allowed to warm up for at least 30 minutes

The run-up of the turbo pump starts. This lasts 2 ... 3 minutes and is visualized by the bar display.



Fig. 6-3 Run-up

Setup parameters

When the "Setup" softkey is pressed, the **Setup** menu appears which allows you to set the operating parameters. (See page 6.4).

Language

See Chapter 6.4.3.

Run-up Details

With the "Details" softkey you go to the **Run-up Details** menu with

- the current fore-vacuum pressure
- the speed of the turbo pump
- the current consumption of the turbo pump
- the status of emission
- the active filament

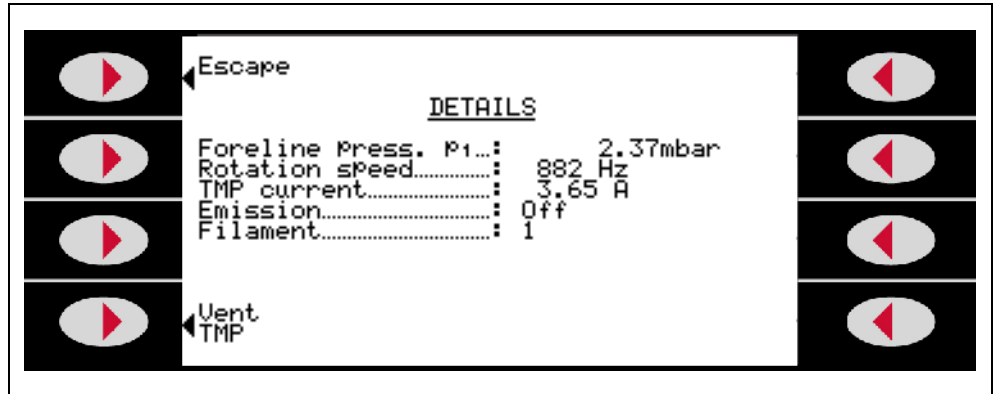

Fig. 6-4 Run-up Details

Press "Escape" to return to the Run-up display.

The "Emission on" is not established until after the filament test when $P_1 < 10\text{mbar}$ and "Speed Turbo $\geq 1450\text{Hz}$ ". After the run-up, the display changes to **Ready to start** unless you have selected **Setup**.

The Softkey "Vent TMP" appears when the maintenance was enabled under "Access control \Rightarrow enable maintenance"

Venting TMP

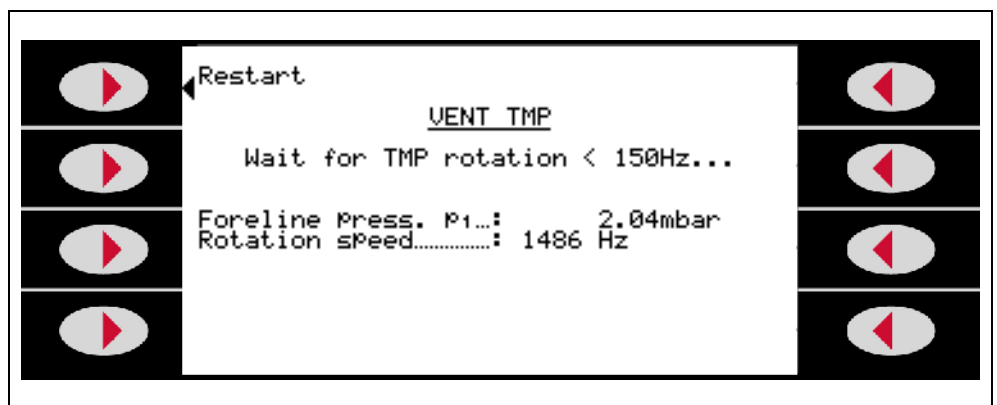

Fig. 6-5 Venting TMP 1

After confirming to Softkey "vent TMP" the TMP is switched off automatically and the leak detector waits until the frequency of the TMP has become smaller than 150 Hz.

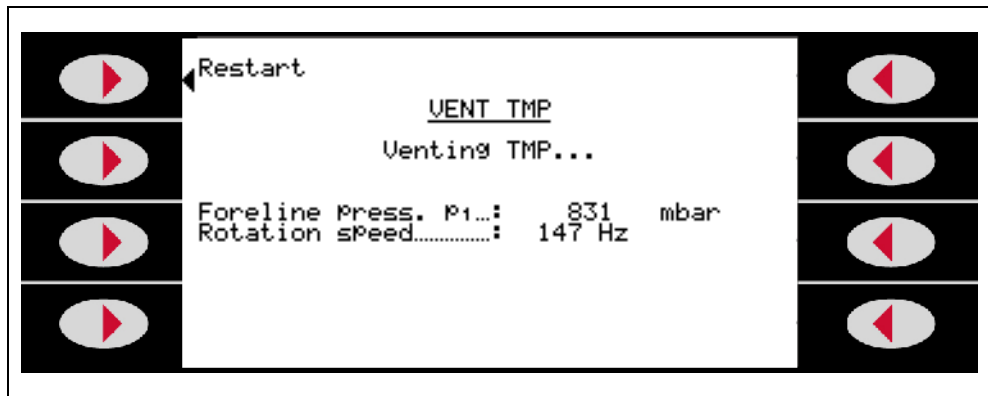

Fig. 6-6 Venting TMP 2

After that the TMP will be vented for 10 seconds.

TMP vented

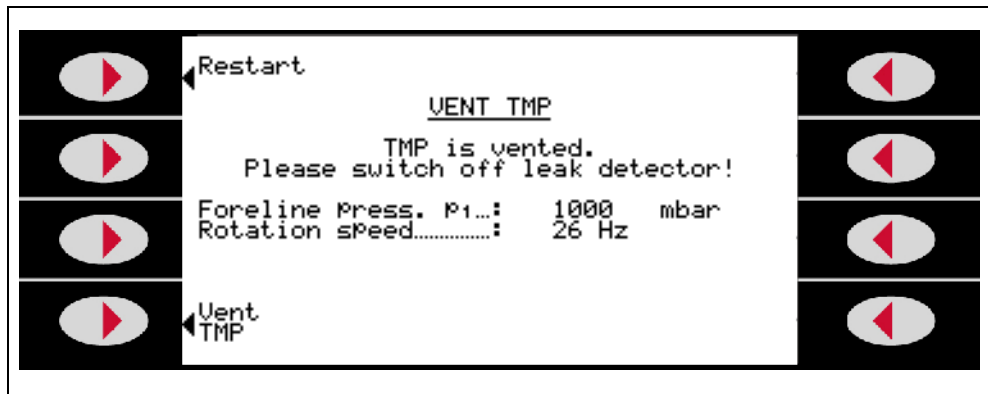

Fig. 6-7 Venting TMP 3

When this 10 seconds have passed the leak detector has to be switched off. The maintenance of the lubricant can be started now.

You can start the leak detector again with the softkey "start new".

You can vent the TMP again with the softkey "vent TMP".

6.2 Ready to start

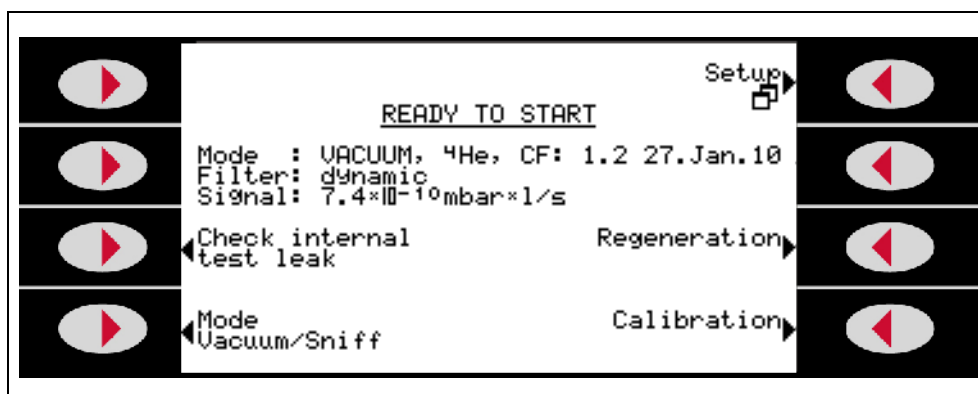

Fig. 6-8 Ready to start

The instrument now displays the following parameters:

Mode	Operating mode (vacuum or sniffing)
Mass	Type of gas (He4, He3, H2)
Filter	Filter stage (without, dynamic, normal)
CF	Date and calibration factor of the last calibration of Twin-Flow™ high (Twin-Flow™ low for sniffing).
Reserve fil. active	Reserve filament active. Only appears if one of the two filaments is defective. This display persists until the filaments (ion sources) are changed.
Signal	Current background signal Only appears if the appropriate option has been selected in the "Underground ready to start" menu. (See Chapter 6.4.1.6)

Softkey "Vent" is only active if in the "Evacuation time & venting" menu (see Chapter 6.4.4.6.5) venting has been set to **manual**.

In case of pending warning message a warning triangle appears at the position of softkey "Check internal test leak" in order to signalise the existent warning. The function enables to consider the previous acknowledged warning message again!

6.2.1 Regeneration

Select
Setup ⇒ Regeneration

The "Regeneration" is an automated Start-Stop - cycle intended for the reduction of a raised helium background.

This function can only be successful activated in the setting "Venting: with Stop".

You can deactivate the "Regeneration" in general with the STOP key or with STOP in the "Regeneration" menu.

An active Regeneration will be announced in the display.

The regeneration stops after 60 minutes automatically.

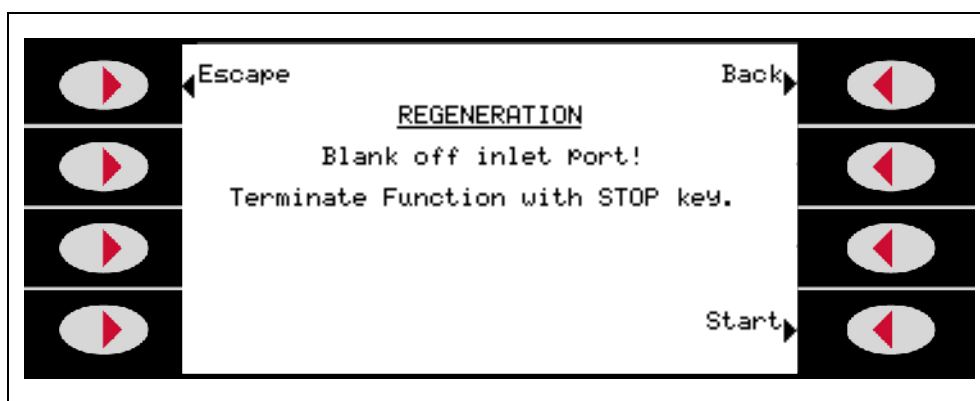

Fig. 6-9

With "Start" you start the following action:

Start, Stop with venting
Start, Stop with venting
and so on.

6.2.2 Check internal test leak

Select
Ready to Start Check internal test leak

This option commences the measuring of the internal test leak. See chapter [6.7](#)

The function is only available in vacuum mode with mass 4.

6.2.3 Setup

Select
Ready to Start ⇒ Setup

This option leads to the Setup menu.

See chapter [6.4](#)

6.2.4 Calibration

This function is only shown if the calibration is enabled in the *Access Control* mode (see Chapter 6.4.2.3).

Select
Ready to Start ⇒ *Calibration*

This option commences the calibration routine. See chapter 6.5 or 6.6, respectively.

6.2.5 Measuring mode Vacuum / Sniffing

This function is only shown if the software menu is not locked by menu PIN (see Chapter 6.4.2.1)

Select
Ready to Start ⇒ *Measuring mode Vacuum / Sniffing*

 **Note**

Observe the detailed instructions for handling the keys in this and the following chapter. Thereafter only menus, parameters and the value tables are described.

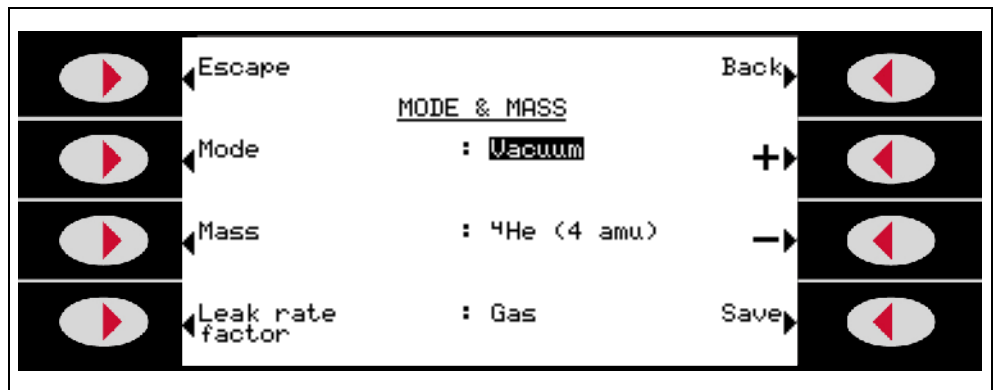

Fig. 6-10 View of the "Mode & mass" setting in the display

- Select the desired option with the softkeys on the right and left of the screen.
- Change the value with the "+" and "-" keys, prolonged pressing causes the parameters to be run through automatically.
- Save the new value with "Save" or
- Go back one level with "Back" or to the measured value or ready to start display with "Escape".

Option	Value range (Min. / Max.)	Description
Mode	Vacuum	Vacuum mode
	Sniffing	Sniffing mode1)
Mass	H2 (2 amu)	detectable gas H2
	3H (3 amu)	detectable gas 3H
	4He (4 amu)	detectable gas 4He
Leak rate factor	Factor 1E-6 ... 1E+6	Leak rate is converted with user-defined factor
	Gas	Leak rate gas equivalent
	Air	Leak rate air equivalent

1) Connect sniffing line before pressing START.

Leak rate factor converts the measured leak rate (⁴He, ³He or H₂) into:

- an equivalent leak rate of another gas or
- into an equivalent leak rate (⁴He, ³He or H₂) under different flow conditions to those of the molecular flow.

Under molecular flow conditions the leak rate only depends on the mass of gas.

Example

We measure the test gas helium 4 and want to display the leak rate for air:

$$LR_{Air} = LR_{He} \times \sqrt{\frac{Mass_{He}}{Mass_{Air}}} = LR_{He} \times \sqrt{\frac{4}{28.964}} = LR_{He} \times 0.372$$

With **leak rate factor air** the leak rate is converted according to the equation with the mass of the test gas (4, 3 or 2) to an equivalent leak rate for air under molecular conditions.

Other gases:

Factors for other gases, e.g. R134a, are obtainable from Pfeiffer-Vacuum.

6.3 Measure

6.3.1 Measure with a test item

The instrument is ready to detect leaks as soon as it displays **Ready to start:**

- Select the desired measuring mode
Mode: **Vacuum** or **Sniffing**
- Check whether the parameters displayed in the Start menu are applicable.

6.3.1.1 Vacuum mode



Danger

Risk of injury due to sucking connection flange.

If the Vacuum-Mode of the SmartTest is activated, the connection flange may suck bodily parts around the connection flange.

Keep bodily parts off the connection flange.

Remove the blank flange from the inlet port and connect the test item.

Press the START / STOP button of the operating unit to start the measurement.

The test item will be evacuated and the pressure displayed during the pumping process.

After achieving the pressure for the measurement the measured value display appears (chapter 6.3.2) and starting with an appropriate background signal (<1E-09 mbar/s) the test item can be charged with helium.

The leak rate of the test item will be shown in the display.

Press the START / STOP button again to stop the measurement.

The SmartTest goes back into Ready to Start; the test item will be vented and can be removed from the inlet port.

6.3.1.2 Sniffing mode

Seal the inlet port with a blank flange and connect the optional sniffing probe LP 5xx. See chapter 5.3.1.

Press the START / STOP button of the operating unit to start the measurement.

The leak rate in the now shown measured value display should adjust to <5E-06 mbar/s (helium fraction of the air).

The helium charged test item can now be leak checked with the sniffing probe.

The appropriate leak rate of the test item will be shown in the display.

Press the START/STOP button again to stop the measurement.

The SmartTest goes back into Ready to Start and the test item will be vented.

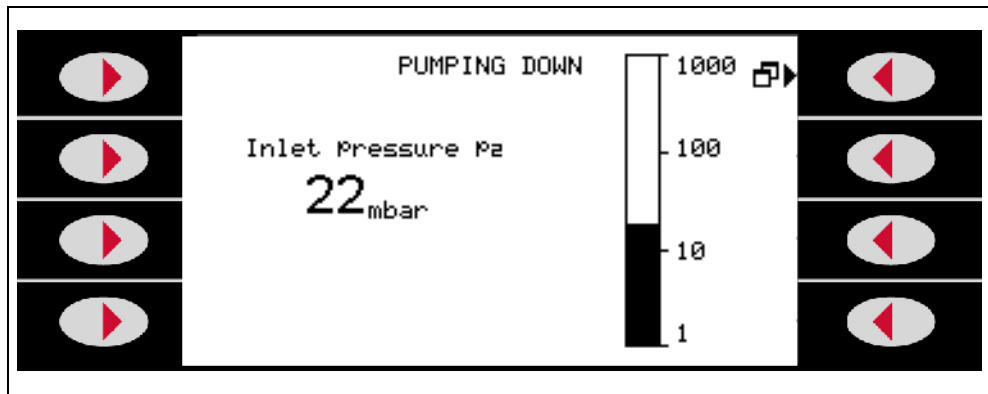

Fig. 6-11 Pump fore-vacuum

The pressure during the pump down process is displayed.

6.3.2 Measured Value Display

On reaching the measuring pressure, the measured value display appears with the display type last used:

- analog/digital with bar display and large numbers or
- graphically as a function of the measuring time or
- You can switch between analog/digital display and the graphic display with the softkey "Bottom right". This alternately bears the analog display or graphic display symbol.

Analog / digital display

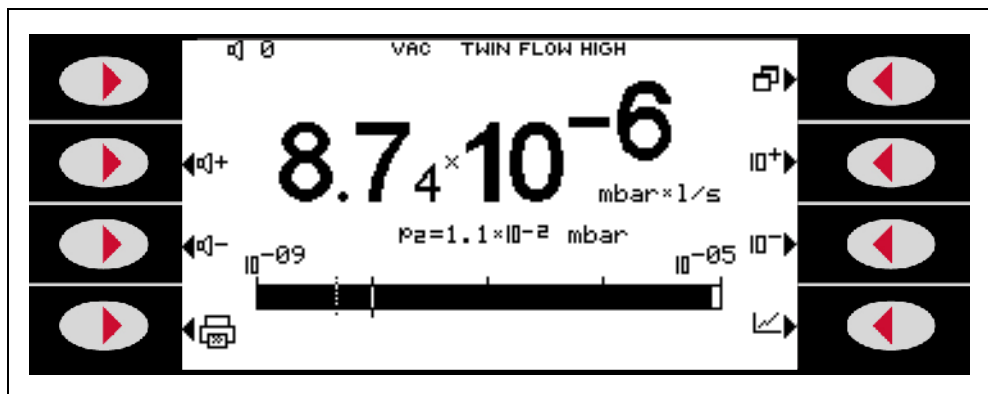

Fig. 6-12 Analogue Display / Digital Display

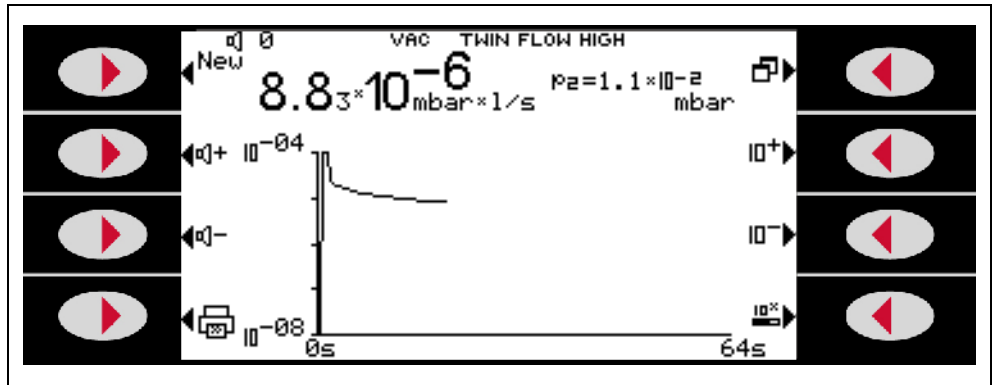

Fig. 6-13 Graphic display (manual scaling)

You can restart the graph with the softkey **New**.

With the softkey **Print** the leak rate, date and time are send to a printer that is connected with the serial port. The interface protocol „Printer“ must be selected (see 6.4.4.4.5).

6.3.3 Display Range Settings

You can select the measuring range with the keys “+” and “-”. Only appears if the **Range-manual** (See Chapter 6.4.1.4) option has been selected in the **Display range** menu.

In case of automatic range selection in the **Display range** menu, the measuring range is adapted to the measuring result by selecting the **Range-automatic** option, so that this is always in the display range. See Chapter 6.4.1.4.

6.3.4 Volume

Press the softkeys “ +” or “ -”

Concern also to Chapter 6.4.4.6.3, Minimum Volume.

6.4 Setup

You can go to the **Setup** menu by pressing the "Setup" softkey in any menu which displays it.



Note

Observe the detailed instructions for handling the keys in this and the following two chapters. Thereafter only menus, parameters and value tables are described.

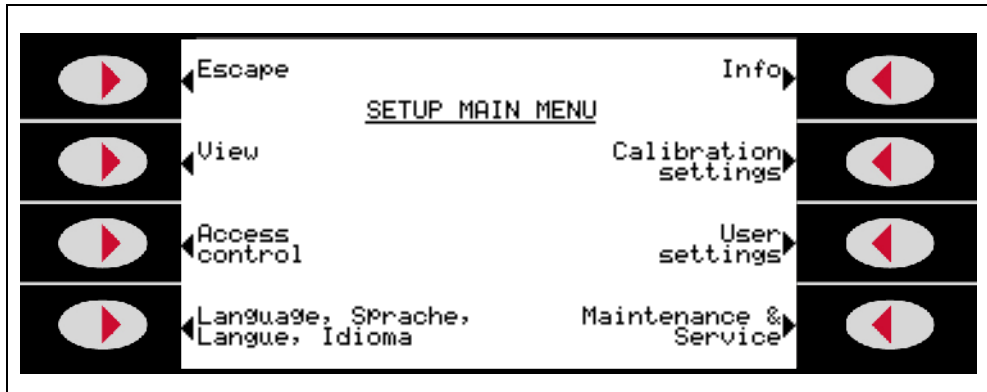

Fig. 6-14 View of the "Setup" extended setting in the display

- Select the desired option with the softkeys on the right and left of the screen.

6.4.1 View

Select
Setup ⇒ View

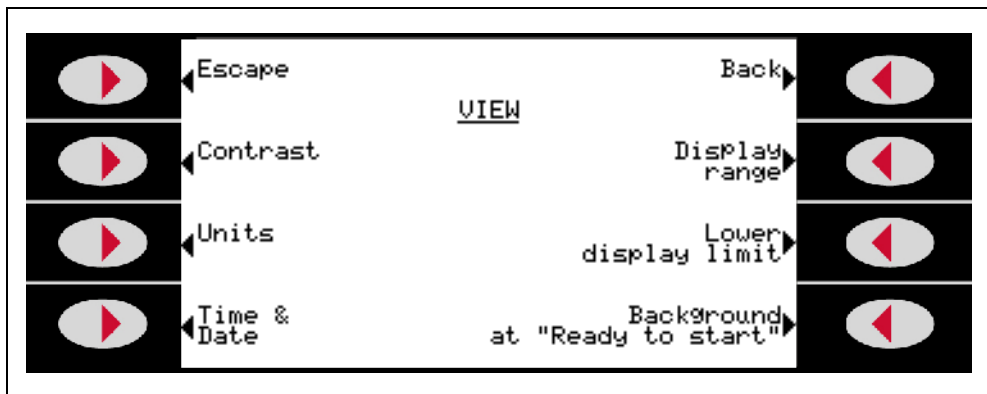

Fig. 6-15 View of the "View" setting in the display

- Select the desired option with the softkeys on the right and left of the screen.

6.4.1.1 Contrast

Select
Setup ⇒ *View* ⇒ *Contrast*

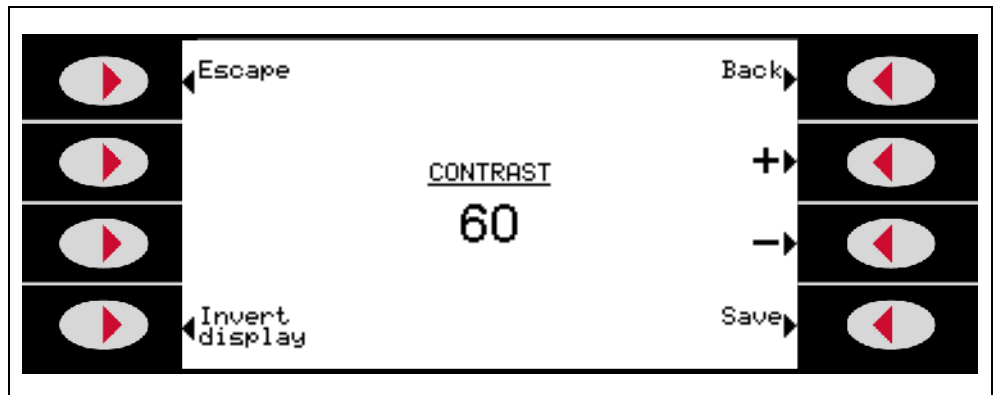

Fig. 6-16 View of the "Contrast" setting in the display

- Select the desired option with the softkeys on the right and left of the screen.
- Change its value with the "+" and "-" keys, prolonged pressing causes the parameters to be run through automatically.
- Save the new value with "Save" or
- Go back one level with "Back" or to the measured value or ready to start display with "Escape".

Option	Value range (Min. / Max.)	Description
Contrast	0 ... 99	Display contrast
Invert display		Switchover display to representation

6.4.1.2 Units

Select
Setup ⇒ View ⇒ Units

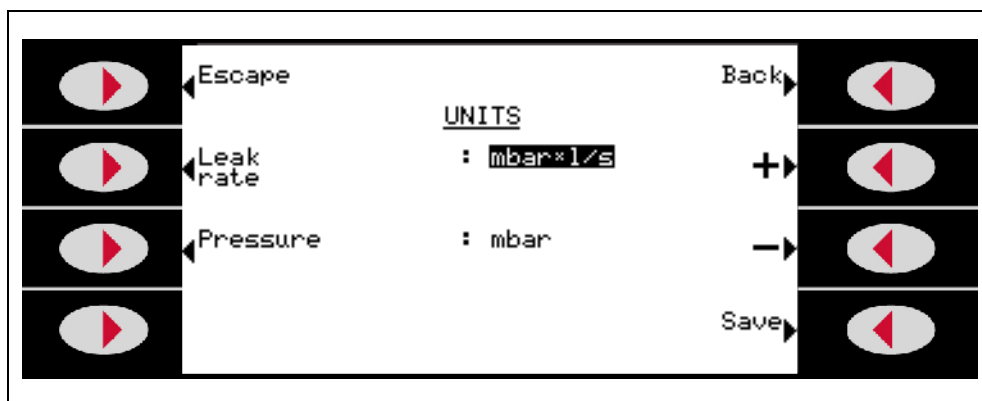

Fig. 6-17 View of the "Units" setting in the display

Option	Value range (Min. / Max.)	Description
Leak rate	mbar *l/s	
	Pa*m3/s	
	Torr*l/s	
	sccm	
	sccs	
	atm*cc/s	
	ppm	(only selectable in "Sniffing" mode)
	g/a	(only selectable in "Sniffing" mode)
	oz/yr	(only selectable in "Sniffing" mode)
Pressure	mbar	
	Pa	
	atm	
	Torr	

6.4.1.3 Time & Date

Select
 Setup ⇒ View ⇒ Time & Date

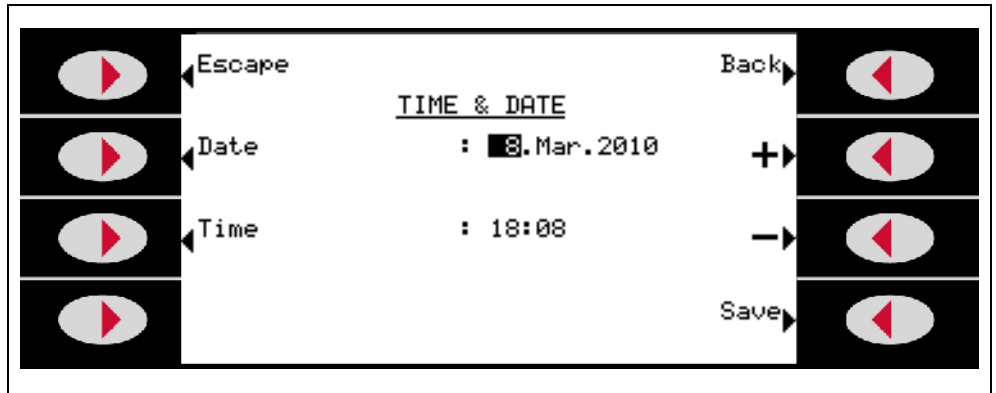

Fig. 6-18 View of the "Time & Date" setting in the display

Option	Value range (Min. / Max.)	Description
Date	e.g. 25th Jan. 2011	Date: Days 1 - 31 Month: Jan. - Dec. Year: 1998 - 2097
Time	e.g. 15:12	Time: Minutes 00 - 59 Hours: 00 - 23

6.4.1.4 Display Range

Select
 Setup ⇒ View ⇒ Display Range

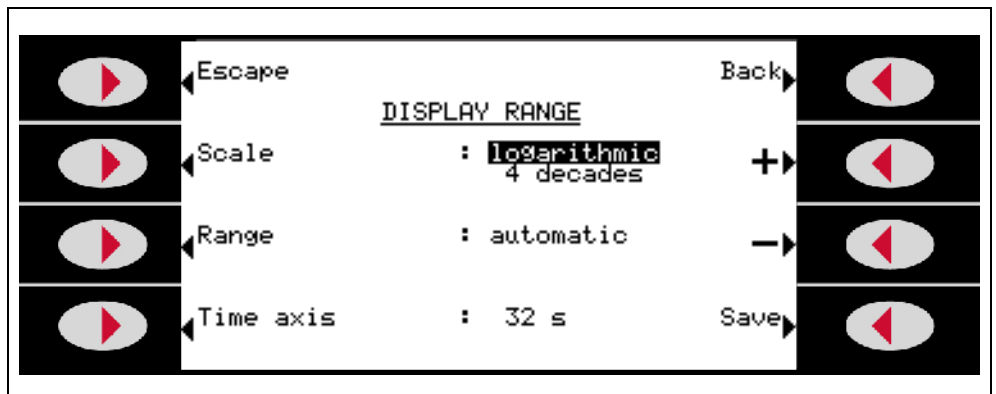

Fig. 6-19 View of the "Display Range" setting in the display

Option	Value range (Min. / Max.)	Description
Scaling	linear	Display linear
	log	Display logarithmic
	dec.	2 ... 9
Range	automatic	automatic range selection
	manual	manual range selection
Time axis	16 ... 960	Time axis, time scale in seconds

6.4.1.5 Lower Display Limit

Select
Setup ⇒ View ⇒ Display Limit

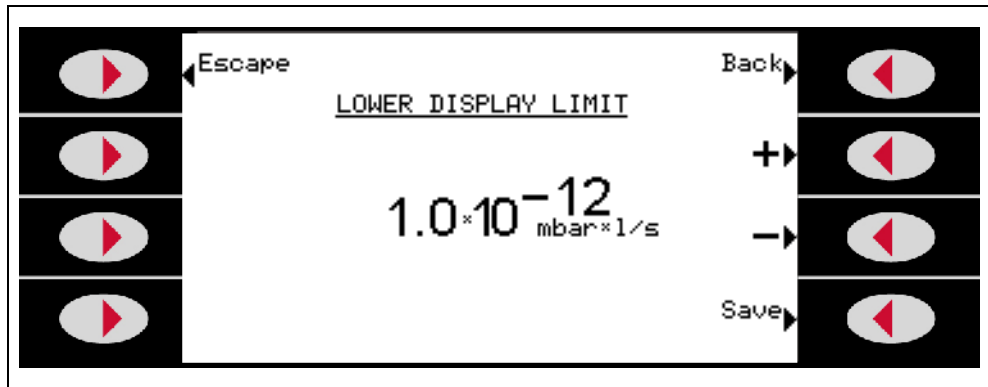

Fig. 6-20 View of the "Lower display limit" setting in the display

Option	Value range (Min. / Max.)	Description
Lower display limit	for unit mbar*l/s: 1E-12 mbar*l/s 1E-11 mbar*l/s 1E-10 mbar*l/s 1E-9 mbar*l/s	This setting limits the display of the leak rate downwards in measuring mode. It is only effective for the vacuum mode.

6.4.1.6 Background at "Ready to Start"

Select
Setup ⇒ View ⇒ Background at "Ready to Start"

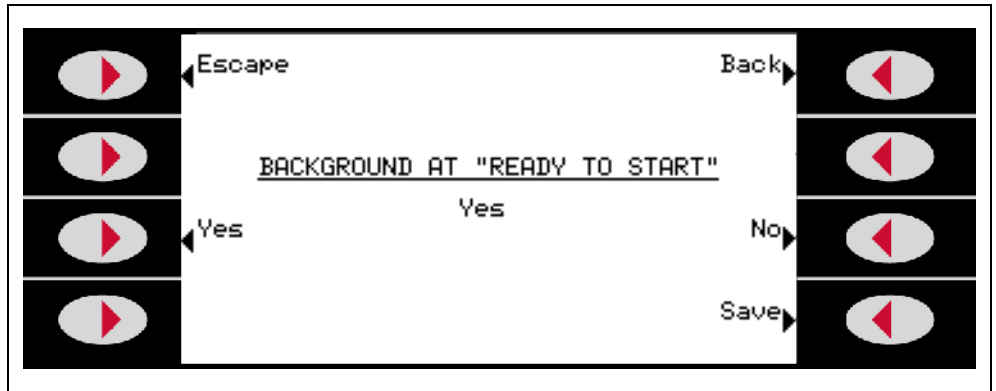

Fig. 6-21 View of the "Ready to start" setting in the display

6.4.2 Access Control

Select
Setup ⇒ Access Control

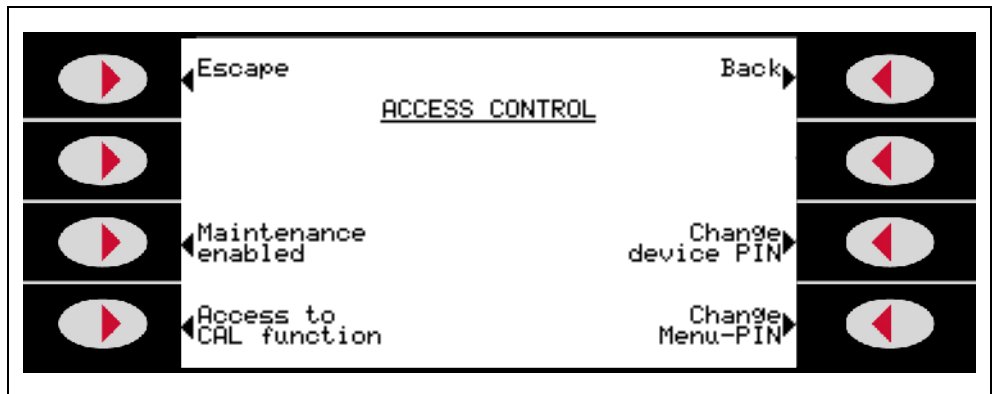

Fig. 6-22 View of the "Access Control" setting in the display

6.4.2.1 Change Menu-PIN

Select
Setup ⇒ *Access Control* ⇒ *Change Menu PIN*

Confines / allows to access the software menu. Exception: The menu Information is always available (See Chapter 6.4.6).

Access to the menu can be restricted by entering or changing the personal identification number (PIN). When you leave the menu the access will be restricted after 2 minutes automatically. The PIN is not checked if it is set to 0000.

Remember the PIN you have entered well. When you have entered a wrong PIN the message "Wrong PIN" will appear. If you forget your PIN please contact Pfeiffer Vacuum.

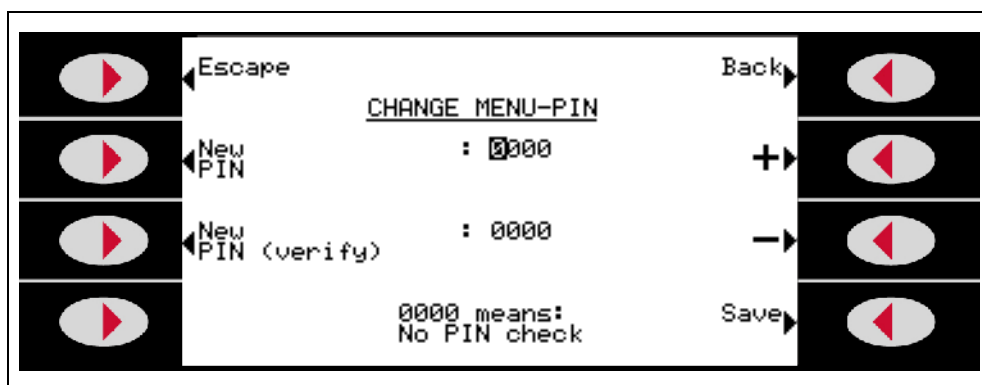

Fig. 6-23

Option	Value range (Min. / Max.)	Description
New PIN	0000 - 9999	New menu PIN
New PIN (verify)	0000 - 9999	New menu PIN (repeat for confirmation)

6.4.2.2 Change Device PIN

Select
Setup ⇒ *Access Control* ⇒ *Change Device PIN*

Confines / allows to use the leak detector.

Access to the leak detector can be restricted by entering or changing the personal identification number (PIN). If the instrument PIN is not 0000, the leak detector asks for the PIN immediately after being switched on. The leak detector cannot be used without entering the correct number.

Remember the PIN you have entered well.

When you have entered a wrong PIN the message "Wrong PIN" will appear. If you forget your PIN please contact Pfeiffer Vacuum

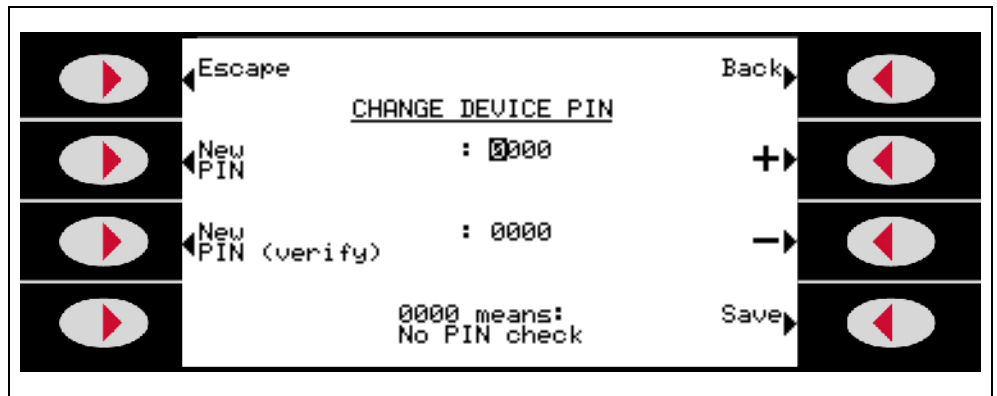

Fig. 6-24 View of the "Change instrument PIN" setting in the display

Option	Value range (Min. / Max.)	Description
New PIN	0000 - 9999	New instrument PIN
New PIN (verify)	0000 - 9999	New instrument PIN (repeat for confirmation)

6.4.2.3 Calibration Enabled

Select
Setup ⇒ *Access Control* ⇒ *Calibration Enabled*

Authorizes for calibration of the leak detector.

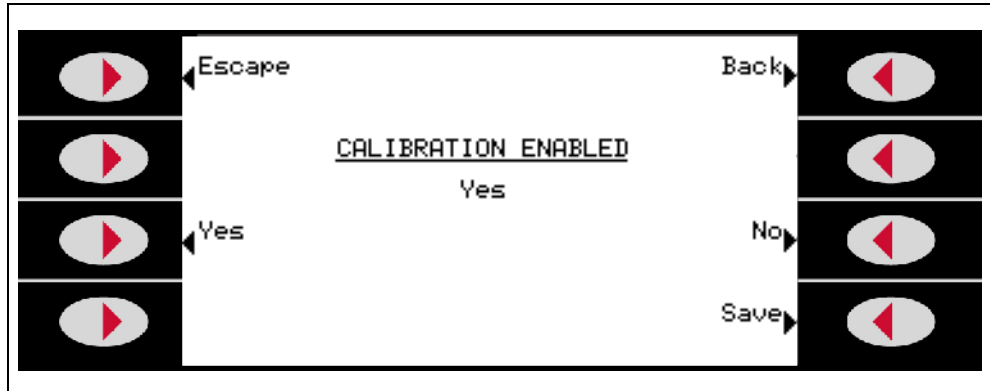

Fig. 6-25 View of the "Enable calibration" setting in the display

Option	Value range (Min. / Max.)	Description
Enable calibration	Yes	The calibration can be started from the "Ready to start" menu
	No	Calibration cannot be started from the instrument operating unit.

6.4.2.4 Maintenance enabled

Select

Setup ⇒ Access Control ⇒ maintenance enabled

Enables the user to use the maintenance menu and the venting of the TMP for changing the lubricant.

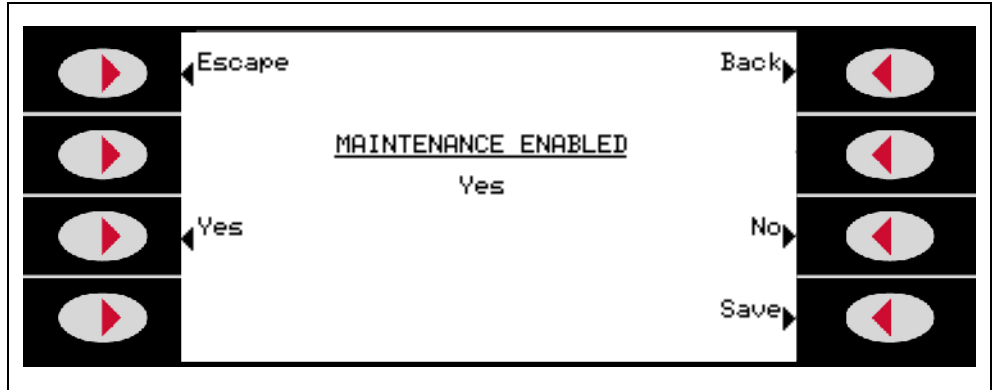

Fig. 6-26 Maintenance enabled

Maintenance enabled	Yes	The menu page Maintenance & Service is enabled. When running-up the TMP can be vented.
	No	The menu page Maintenance & Service will be blanked. When running-up the TMP cannot be vented.

6.4.3 Language

Select
Setup ⇒ Language

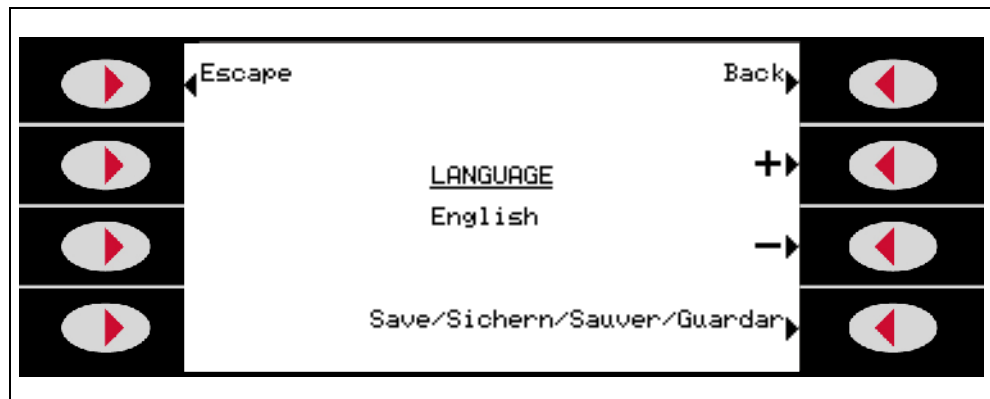

Fig. 6-27 View of the "Language" setting in the display

Option	Value range (Min. / Max.)	Description
Language	English	Operating language English
	German	Operating language German
	French	Operating language French
	Spanish	Operating language Spanish
	Chinese	Operating language Chinese
	Russian	Operating language Russian

6.4.4 User Settings

Select
Setup ⇒ User Settings

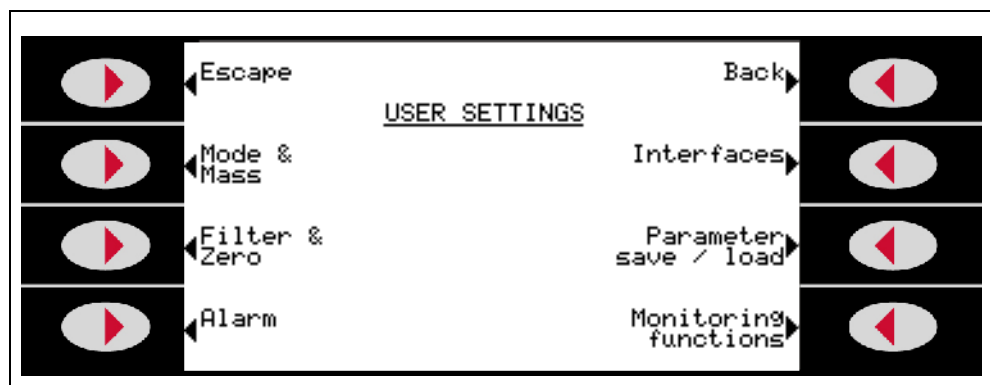

Fig. 6-28 View of the "User" setting in the display

6.4.4.1 Mode & Mass

Select
 Setup ⇒ User settings ⇒ Mode & Mass

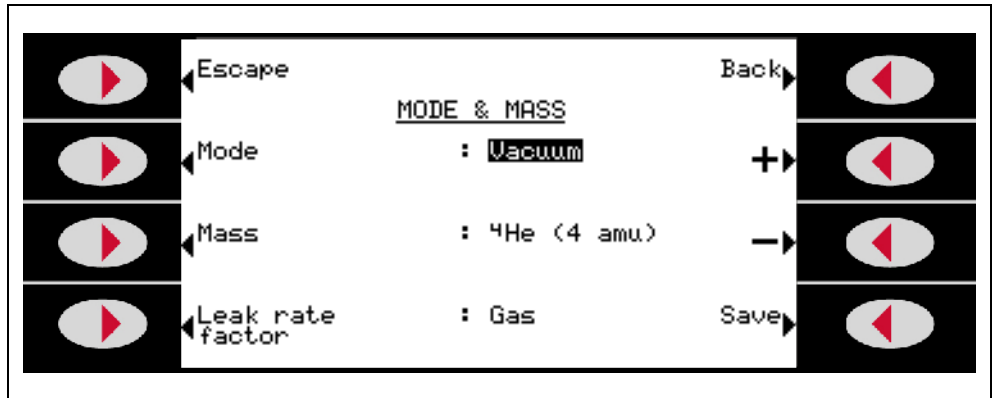

Fig. 6-29 View of the "Mode & mass" setting in the display

Option	Value range (Min. / Max.)	Description
Mode	Vacuum	Vacuum mode
	Sniffing	Sniffing mode1)
Mass	H2 (2 amu)	detectable gas H2
	3H (3 amu)	detectable gas 3H
	4He (4 amu)	detectable gas 4He
Leak rate factor	Factor 1E-6 ... 1E+6	Leak rate is converted with user-defined factor
	Gas	Leak rate gas equivalent
	Air	Leak rate air equivalent

1) Connect sniffing line before pressing START.

Leak rate factor converts the measured leak rate (⁴He, ³He or H₂) into:

- an equivalent leak rate of another gas or
- into an equivalent leak rate (⁴He, ³He or H₂) under different flow conditions to those of the molecular flow.

Under molecular flow conditions the leak rate only depends on the mass of gas.

Example

We measure the test gas helium 4 and want to display the leak rate for air:

$$LR_{\text{Air}} = LR_{\text{He}} \times \sqrt{\frac{\text{Mass}_{\text{He}}}{\text{Mass}_{\text{Air}}}} = LR_{\text{He}} \times \sqrt{\frac{4}{28.964}} = LR_{\text{He}} \times 0.372$$

With **leak rate factor air** the leak rate is converted according to the equation with the mass of the test gas (4, 3 or 2) to an equivalent leak rate for air under molecular conditions.

Other gases:

Factors for other gases, e.g. R134a, are obtainable from Pfeiffer-Vacuum.

6.4.4.2 Filter & Zero

Select

Setup ⇒ User settings ⇒ Filter & Zero

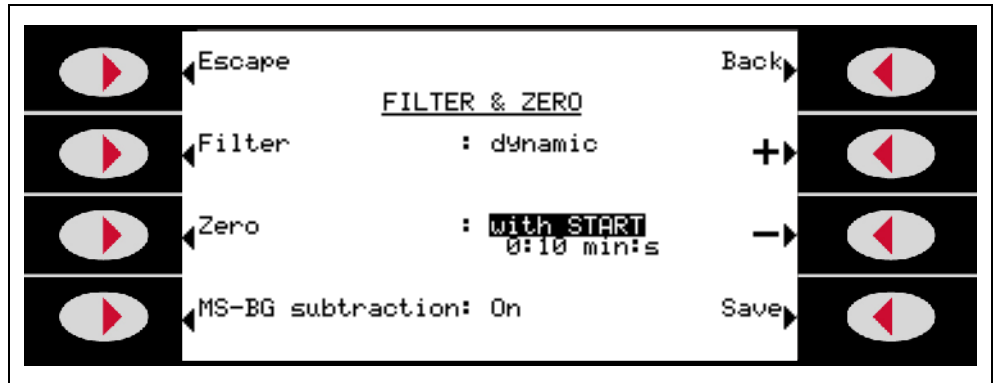

Fig. 6-30 View of the "Filter & Zero" setting in the display

Option	Value range (Min. / Max.)	Description with variable time constant
Filter	dynamic	Leak rate filter with dynamic adaptation of the time constant
	static	Leak rate filter with fixed time constant
	without	No leak rate filter
Zero	locked	Manual background suppression locked
	released	Manual background suppression released
	with START min:sec 2 s / 5 min	When the sensitive and released measuring range is reached, ZERO is executed immediately after the specified time
	constant	Subtracts a zero value saved once by pressing the Zero key from the raw signal. The automatic background suppression is locked. The zero value is retained after pressing the Stop key. Pressing the Zero key again overwrites the zero value. The zero value is set to "0" at Power-Off, deactivation of the zero function by pressing the zero button more than 3 s or changing the zero function.

MS-BG subtraction Not available in option "Zero constant"	on	<p>The internal mass spectrometer background is subtracted at START.</p> <p>The internal background is generated by residual gas (e. g. Helium) that has not been pumped away yet. Sources for residual gas are air or absorbed gases from the inner surfaces of the leak detector. This internal background will never disappear totally. Very clean systems which have been pumped for a long time will show a background in the 10-11 mbar l/s range. Under normal conditions the background level is in the 10-10 mbar l/s or low 10-9 mbar l/s range.</p> <p>When pressing START the current internal background is subtracted from all further measured signals automatically. Thus it is made sure that only the net leak rate from the part under test is measured.</p> <p>When switched to START / STOP mode again a new internal background is calculated after 25 s.</p>
	off	<p>The internal mass spectrometer background (MS-BG) is not subtracted at START.</p> <p>See description "on".</p>



Warning

Zero constant function:

The automatic background suppression is not active. The zero value is retained after pressing the Stop key. This may mean that some leaks may not be detected.

An active suppression of the underground will be displayed ([Fig. 6-12/](#)[Fig. 6-13](#)) in the status line as follows:

ZERO	appears after pressing the zero button shortly in the zero option "released" or "with start"
ZERO START	appears after the provided time has passed in the zero option "with start"
ZERO CONSTANT	appears after pressing the zero button shortly in the zero option "constant"

For further information on Zero constant function see Chapter [3.5](#).

6.4.4.3 Alarm

Select
Setup ⇒ User Settings ⇒ Alarm

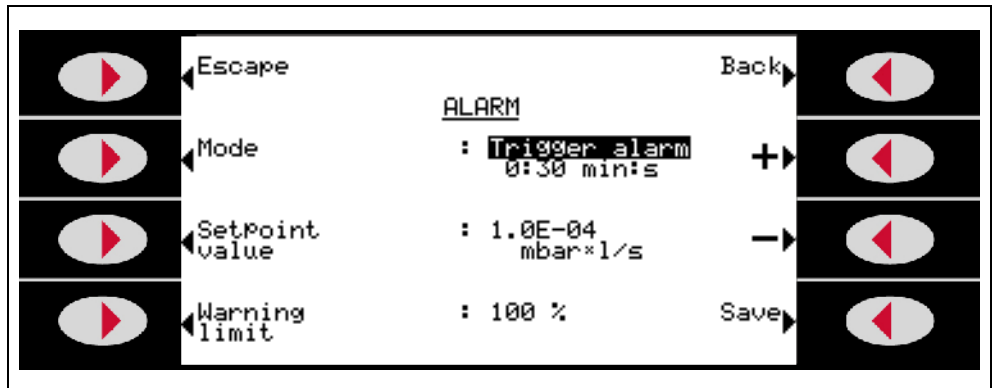

Fig. 6-31



Warning

The hearing can be harmed by the audio alarm.
The acoustic output can exceed a level of 85dB(A).
Do only expose to the audio alarm for a short time or use ear protection.

Option	Value range (Min. / Max.)	Description with variable time constant
Mode	Prop. leak rate	The frequency of the acoustic signal is proportional to the bar display. The frequency range is 300 Hz to 3300 Hz.
	Trigger Alarm 0 min / 4.5 min	No tone is emitted if the leak rate is smaller than the warning limit. A continuous tone is emitted if the leak rate is greater than the warning limit and smaller than the setpoint value. A multi-frequency signal is generated as soon as the leak rate exceeds the setpoint value. The signal remains even when the leak rate changes. An alarm delay time can be entered additionally (see below).
	Setpoint 0 min / 4.5 min	No tone is emitted if the leak rate is smaller than the warning limit. A continuous tone is emitted if the leak rate is greater than the warning limit. A tone with a frequency proportional to the leak rate is emitted as soon as the leak rate exceeds the setpoint value. A continuous tone is emitted if the leak rate is greater than 100*setpoint value. An alarm delay time can be entered additionally (see below).

Option	Value range (Min. / Max.)	Description with variable time constant
Mode	Pinpoint	The frequency of the acoustic signal is proportional to the leak rate between 0.1*setpoint value and 10*setpoint value. A constant low tone is emitted if the leak rate is lower than 0.1*setpoint value. A constant high tone is emitted if the leak rate is greater than 10*setpoint value.
Setpoint value	1E-12...9.9E+2 mbar l/s	Alarm setpoint value
Warning limit	1...100%	Warning limit as percentage of the setpoint value

In some applications (for example during the pump down of a "test chamber system") it may be necessary to suppress an alarm for some time after pressing the START key.

After pressing the START key the acoustic signal can be activated: as soon as the leak rate is lower than the warning limit or when the alarm delay has proceeded or when the type of alarm "Prop. leak rate" i.e. "Pinpoint" or the sniffer mode is adjusted.

6.4.4.4 Interfaces

Select

Setup ⇒ User Settings ⇒ Interfaces

Interfaces enables selection of the displayed sub-menu.

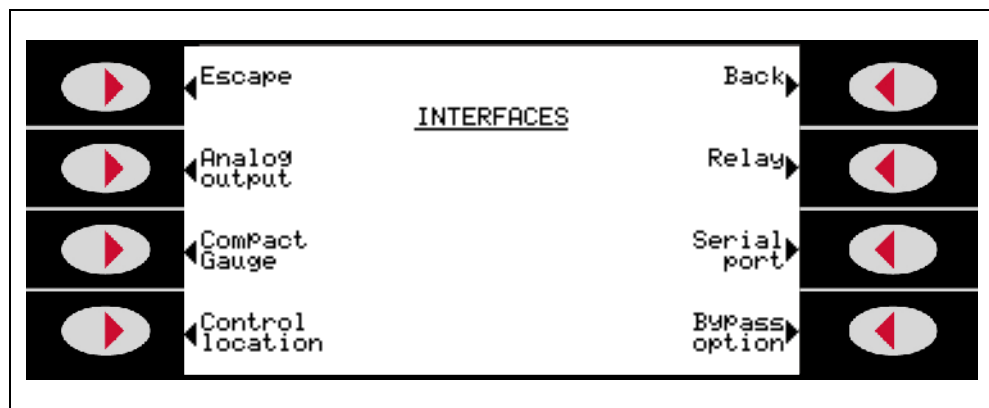

Fig. 6-32 Interfaces

6.4.4.4.1 Analog Output

Select

Setup ⇒ User Settings ⇒ Interfaces ⇒ Analog Output

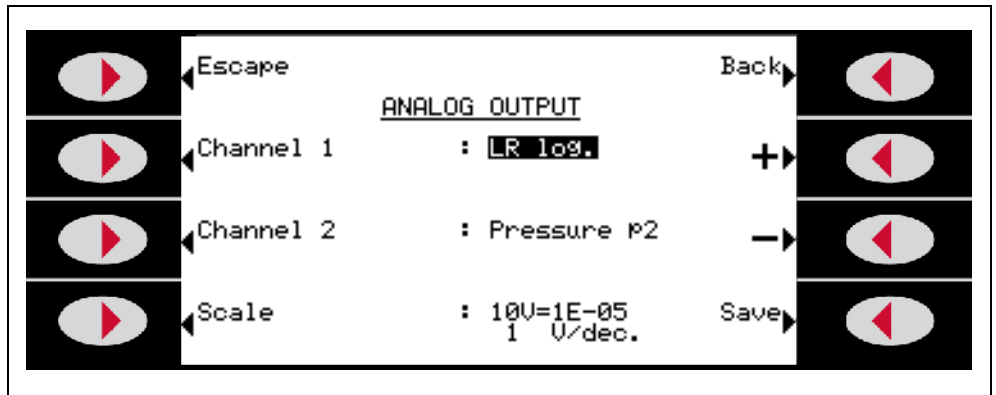

Fig. 6-33

Option	Value range (Min. / Max.)	Description with variable time constant
Channel 1	Off	Channel 1 is switched off (0 V)
	Pressure p2	The inlet pressure p2 is output on channel 1. (See pirani characteristic in appendix)
	Pressure p1	The fore-vacuum pressure p1 is output on channel 1. (See pirani characteristic in attachment)
	LR mantissa	The leak rate mantissa is output linearly from 1...10 V (i.e. 5.4×10^{-7} mbar l/s is according to 5.4V)
	LR exponent	The exponent is output as a step function: $U = 1...10$ V in steps of 0.5 V per decade starting with 1 V = 1×10^{-12} (i.e. 5.4×10^{-7} mbar l/s is according to 3.5V).
	LR linear	The leak rate is put out linearly from 0...10 V. 10 V are analogue to the "upper limit" in scaling. The upper limit (=10V) is forced through the adjustment "scaling → upper limit" (see below). Example: 5.4×10^{-7} mbar l/s and the upper limit are according to 5.4V.

Option	Value range (Min. / Max.)	Description with variable time constant
Channel 1	LR log.	The output voltages are scaled logarithmically. The output voltage is 0...10 V in adjustable steps of 0.5 V to 10 V per decade (see Scaling setting). The upper limit (=10V) is forced through the adjustment "scaling → upper limit" (see below). The pitch is forced through "scaling → V/decade". Example: 1 x 10 ⁻⁷ mbar l/s, upper limit 1 x 10 ⁻⁶ mbar l/s and 2V/decade is according to output voltage 8V.
	Pressure p(ext)	The voltage of the external gauge head is emitted. For converting the pressure of the pressure / voltage see Operating Instructions of the compact gauge head.
Channel 2	see channel 1	analog with channel 1
Scale	upper limit: 1E-11 ... 1E+6	upper limit (=10 V) for setting "LR log" and "LR linear".
	V/decade: 0,5, 1, 2, 2,5, 5, 10	Volt per decade for setting "LR log".

6.4.4.4.2 Compact Gauge

Setup ⇒ User Settings ⇒ Interfaces ⇒ Compact Gauge

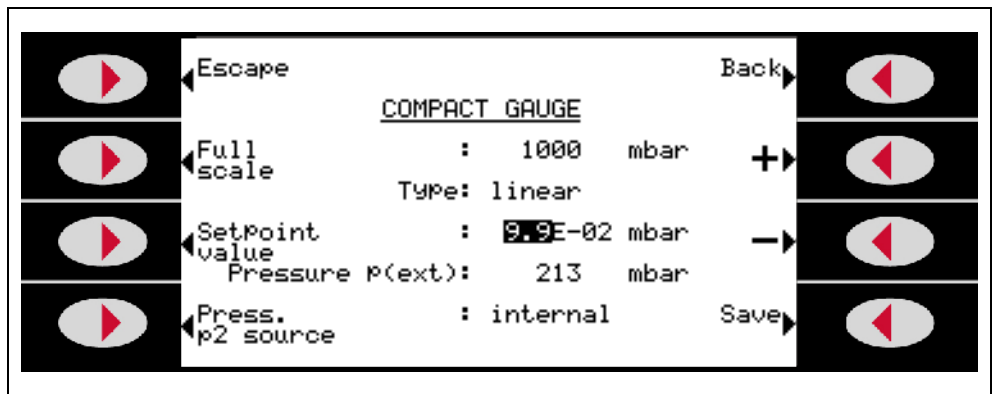



Fig. 6-34 Compact Gauge

Option	Value range (Min. / Max.)	Description with variable time constant
Full deflection (only in linear gauge heads)	0.1 mbar 1 mbar 10 mbar 100 mbar 1000 mbar 2000 mbar 5000 mbar 10000 mbar 50000 mbar	Set the full deflection value (F.S.) according to the rating plate of the gauge head.
Threshold value	1E-10...9.9E+2 mbar	The threshold value for relay output
Pressure p2 source	external	The inlet pressure is determined by an external pressure measuring point.
	internal	The inlet pressure is determined by an internal pressure measuring point.

In addition the type of the currently connected gauge head is displayed under "Type" and the measured value of the gauge head under "Pressure p(ext)".

The pressure value for the gauge head type TPR / PCR is only shown below 1000 mbar. Pressures of more than 1000 mbar are shown as >1000 mbar in the display.

Usable compact gauge heads, see appendix.

 **Note**

PBR and IMR may **not** be connected because of the increased power requirement.

6.4.4.4.3 Control Location

Select
 Setup ⇒ User Settings ⇒ Interfaces ⇒ Control Location

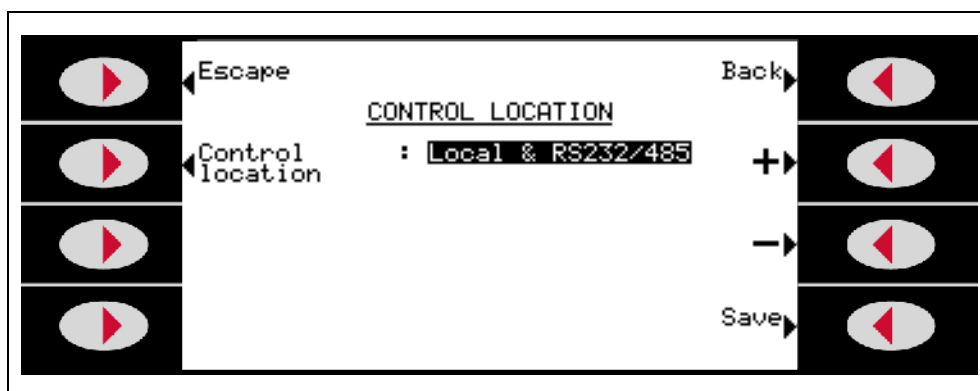

Fig. 6-35 View of the "Control location" setting in the display

Option	Value range (Min. / Max.)	Description
Control location	Local	The HLT5xx is controlled by the START, STOP and ZERO keys.
	Local and RS232 / RS485	The HLT5xx is controlled both by the START / STOP and ZERO keys on the instrument and via the RS232 / RS485 interface.
	RS232 / RS485	The HLT5xx is controlled via the RS232 / RS485 interface by an external computer. The START / STOP and ZERO keys on the instrument are deactivated.
	All	The HLT5xx is controlled both by the START / STOP and ZERO keys on the instrument and also via the digital inputs and the RS232/RS485-Interfaces.
	PLC	The HLT5xx is controlled via the digital input. The START / STOP and ZERO keys on the instrument are deactivated.

6.4.4.4.4 Relay

Setup ⇒ User Settings ⇒ Interfaces ⇒ Relay

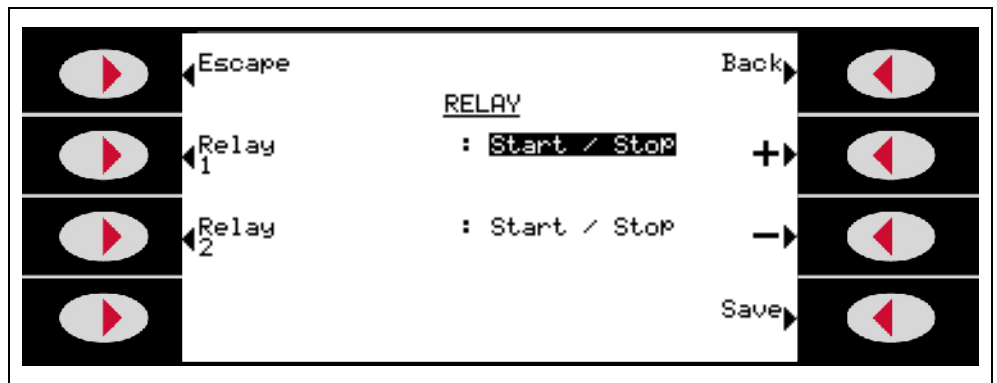

Fig. 6-36 Relay view of the "Relay" setting in the display

Relay allows independent settings for the two output relays.

Parameter	Settings	Explanation
Relay 1 and Relay 2	Off 1)	Relay always dropped out
	Start	Relay activates when valve V2 opens and drops when valve V2 closes (→ Fig. 3-2).
	Stop	Relay activates when valve V6 opens and drops when valve V6 closes (→ Fig. 3-2).
	START / STOP	Relay activates at START and drops out at STOP.
	Ready	Relay activates when measuring
	Setpoint	Relay activates when the leak rate exceeds the setpoint value and drops out when it falls 10% below the threshold value (→ chapter 6.4.4.3).
	On 1)	Relay always activated
	Warning limit LR	Relay activates when the leak rate exceeds the warning limit (→ chapter 6.4.4.3).
	Pressure setpoint	Relay pulls up when the pressure in the external gauge head is greater than its setpoint (→ chapter 6.4.4.2).

¹⁾ The settings **off** and **on** are very suitable for checking the external relay switching. Connections → see appendix.

6.4.4.4.5 Serial Port

Select
 Setup ⇒ User Settings ⇒ Interfaces ⇒ Serial Port

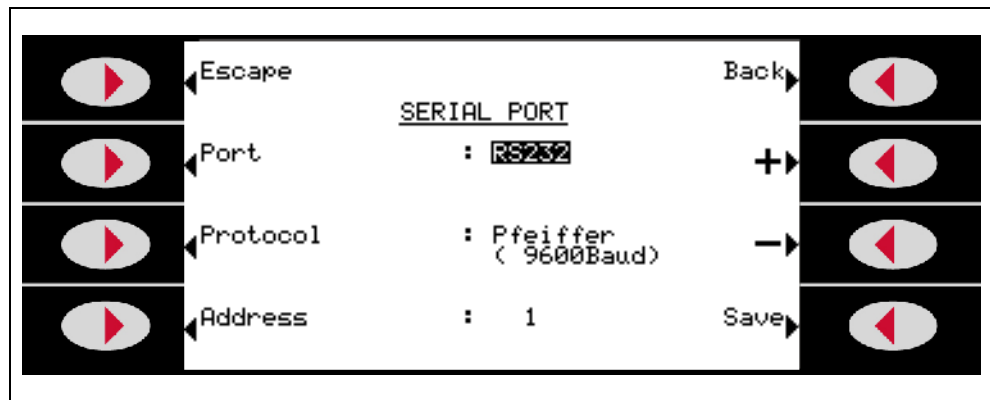

Fig. 6-37 Serial port

Option	Value range (Min. / Max.)	Description
Interface	RS232 / RS485	Selection whether the RS232 or the RS485 is to be used.
Protocol	HLT2xx	The interface protocol of the HLT2xx. This protocol should only be used in applications in which the HLT5xx replaces a HLT2xx. This protocol only covers part of the functional scope of the HLT2xx so that no full compatibility between it and the HLT5xx is guaranteed. Baudrate: 9600 or 19200
	Pfeiffer	The Pfeiffer protocol Baudrate: 9600
	Binary	The interface protocol for the instrument diagnosis. Baudrate: 19200
	Printer	Leak rate, date and time are given on a printer after the softkey „Print“ in the „measured value display“ is pressed. Baudrate: 9600
Address (only available in Pfeiffer Protocol)	1 - 255	Bus-address of the SmartTest in Pfeiffer-Protocol
Baudrate (only available with HLT5xx protocol)	9600 or 19200	Baudrate of SmartTest in HLT5xx protocol.

6.4.4.4.6 Bypass Option

This option is only available, if a bypass valve is installed.

Select

Setup ⇒ User Settings ⇒ Interfaces ⇒ Bypass Option

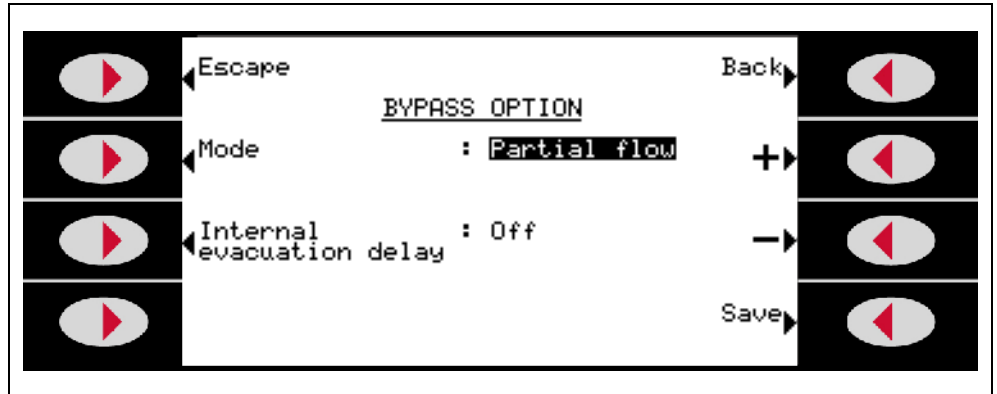

Fig. 6-38 View of the "Bypass option" setting in the display

Option	Value range (Min. / Max.)	Description
Mode	No bypass	see below
	Partial flow	see below
	Quick pump	see below
Internal pump-down delay	on	see below
	off	see below

Explanations:

Mode	Pump down without internal pump down delay	Measure without internal pump down delay	Pump down with internal pump down delay	Measure with internal pump down delay
No bypass	int. pump	int. pump	int. pump	int. pump
Quick pump	Partial flow pump + int. pump	int. pump	Partial flow pump	int. pump
Partial flow	Partial flow pump + int. pump	Partial flow pump + int. pump	Partial flow pump	Partial flow pump + int. pump

6.4.4.5 Parameter save / load

Select
Setup ⇒ User settings ⇒ Parameter save / load

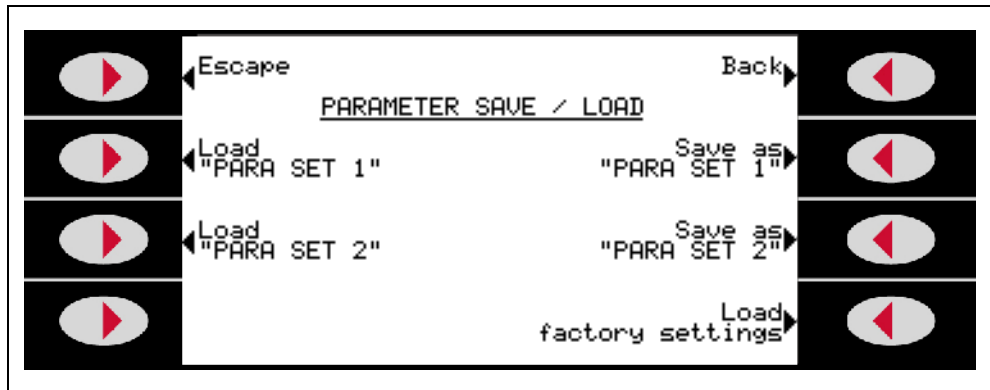

Fig. 6-39 Parameter save / load

6.4.4.5.1 Load PARA Set 1 / 2

Select
Setup ⇒ User settings ⇒ Parameter save / load ⇒
Load PARA Set 1 / 2



Fig. 6-40 Example Parameter set 1

The Softkey "View parameter set" leads to 4 more pages of parameter values of the parameter set.

6.4.4.5.2 Load Factory Settings

Select

Setup ⇒ User Settings ⇒ Parameter save / load ⇒ Load Factory Settings

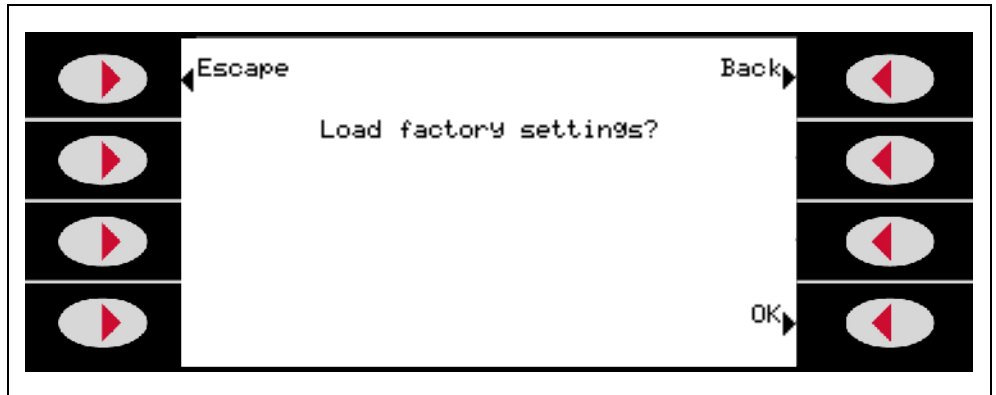

Fig. 6-41 Default parameter

List of default parameter see appendix.

6.4.4.5.3 Save PARA Set 1 / 2

Select

Setup ⇒ User settings ⇒ Parameter save / load ⇒
Save PARA Set 1 / 2

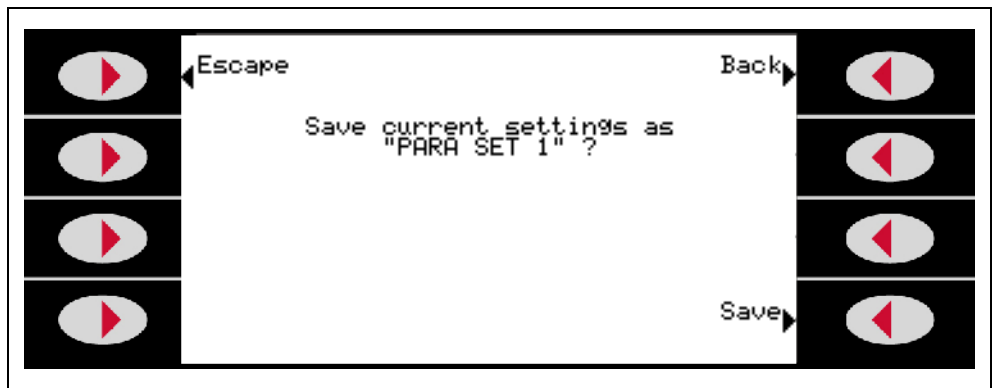

Fig. 6-42 Save PARA Set 1

The parameter set will be saved after pressing the button "Save".

6.4.4.6 Monitoring functions

Select
 Setup ⇒ User Settings ⇒ Monitoring Functions

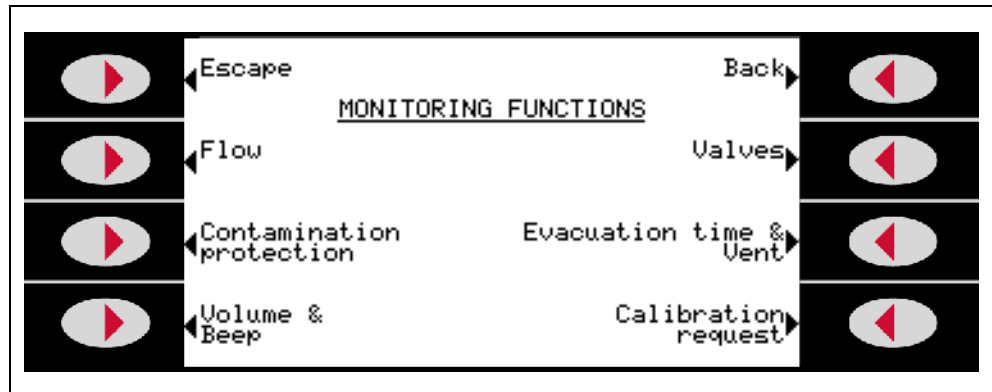

Fig. 6-43 Monitoring functions

6.4.4.6.1 Flow

Select
 Setup ⇒ User Settings ⇒ Monitoring Functions ⇒ Flow

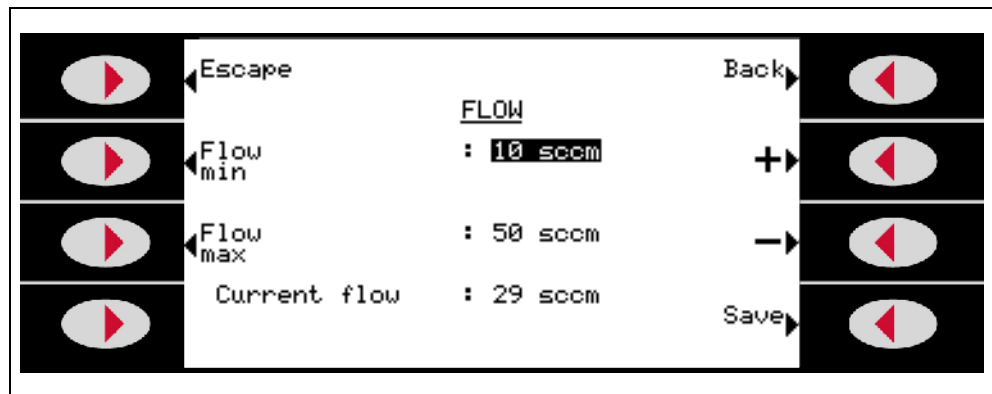

Fig. 6-44 Flow menu

Option	Value range (Min. / Max.)	Explanation
Flow min.	1...40 sccm	The warning "Flow too low" appears if the flow drops below this value during the measuring mode.
Flow max.	10...50 sccm	The warning "Flow too high" appears if this value is exceeded during the measuring mode.

The flow control only concerns the sniffing mode (mode: sniffing) and serves for monitoring the sniffing probe.

If menu "flow" is activated while measurement the current flow will be displayed.

6.4.4.6.2 Contamination Protection

Select

Setup ⇒ User Settings ⇒ Monitoring Functions ⇒ Contamination Protection

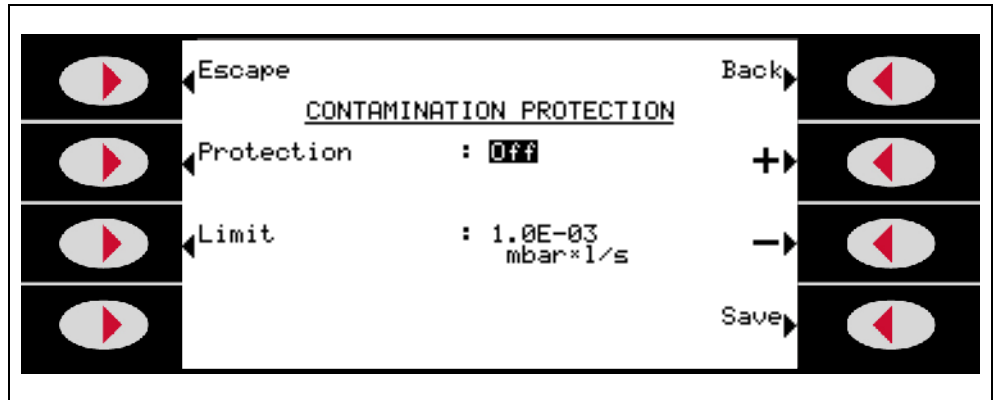

Fig. 6-45 View of the "Contamination protection" setting in the display

Option	Value range (Min. / Max.)	Explanation
Protection	On	Contamination protection is switched on
	Off	Contamination protection is switched off
Limit	1E-9 ... 1E+3 mbar*l/s	Switch off limit value for the contamination protection function

If the contamination protection is switched on, the SmartTest closes all inlet valves as soon as the measured leak rate exceeds the limited value. Then only a small amount of helium gets into the mass spectrometer. Contamination of the leak detector by helium is avoided. The helium which gets into the sample can then be pumped off by an external pump. If no extra pump is available, we recommend venting the sample before continuing the measurements.

Notice: Contamination protection will be activated not before alarm delay time is finished (see Chapter 6.4.4.3)

6.4.4.6.3 Volume & Beep

Select

Setup ⇒ User Settings ⇒ Monitoring Functions ⇒ Volume & Beep

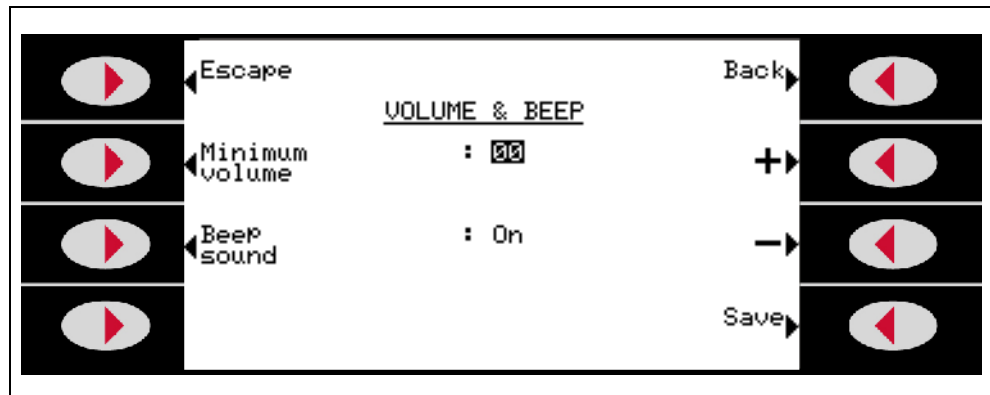

Fig. 6-46 Volume settings

Option	Value range (Min. / Max.)	Explanation
Minimum volume	0...15	The minimum volume must be reached. This prevents the volume being accidentally set so quiet that you can no longer hear the alarm signal.
Beep sound	On / Off	The "beep" tones can be switched on and off. "Beep" tones signal a change in status for example.

6.4.4.6.4 Valves

Select
 Setup ⇒ User Settings ⇒ Monitoring Functions ⇒ Valves

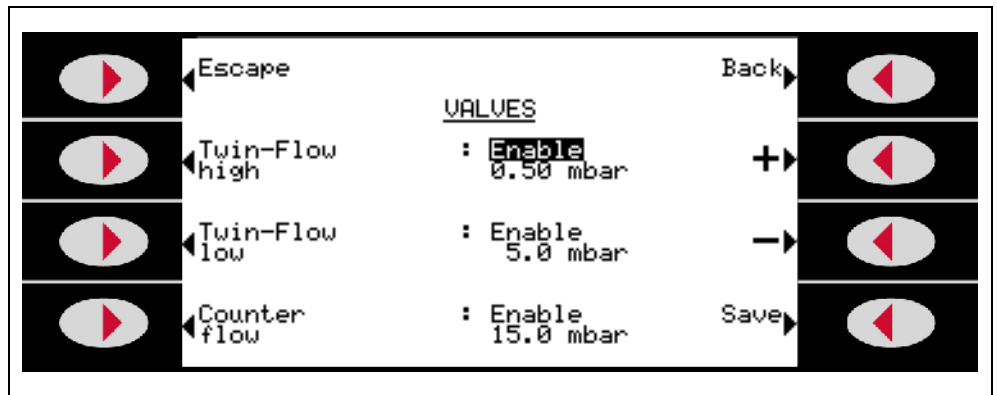



Fig. 6-47 View of the "Valves" setting in the display

Option	Value range (Min. / Max.)	Explanation
Twin-Flow high	released	released
	locked	locked
	0.01 ... 0.5 mbar	Pressure at which valve V4 opens
Twin-Flow low	released	released
	locked	locked
	0.1 ... 5 mbar	Pressure at which valve V3 opens
Counterflow	released	released
	locked	locked
	0.1 ... 25 mbar	Pressure at which valve V1 opens

In sniffer mode the adjustments cannot be changed.

 **Note**
 The change in the illustrated standard settings can lead to a considerable reduction in the performance of the instrument.

 **Note**
 Counterflow operation at 15 ... 25 mbar represents a heavy strain for the turbo pump. We recommend that you do not use continuous operation in this pressure range.

6.4.4.6.5 Evacuation Time & Vent

Select

Setup ⇒ User Settings ⇒ Monitoring Functions ⇒ Evacuation Time & Vent

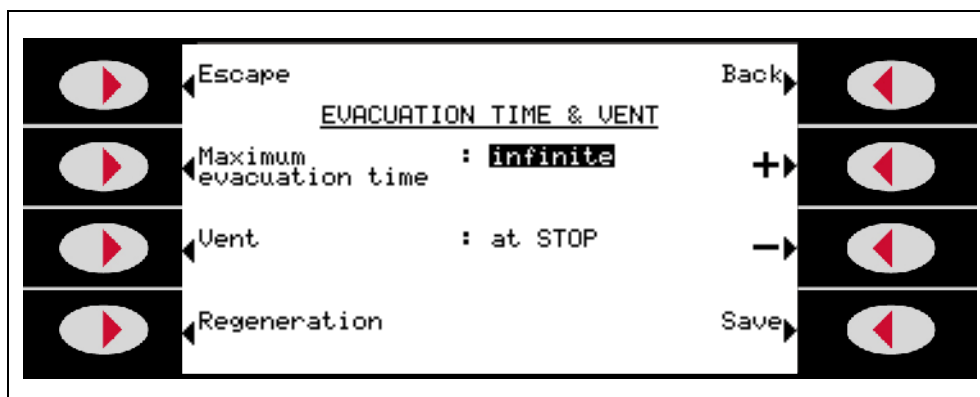

Fig. 6-48 View of the "Evacuation time & Venting" setting in the display

Option	Value range (Min. / Max.)	Explanation
Maximum evacuation time	1s ... 30 min infinitely	If the sample has a strong leak it cannot be pumped down as quickly as if it had no leak. The maximum evacuation time defines the time which allows the sample to be pumped down to a pressure of 15 mbar. If this time is exceeded, the pump down process stops and an appropriate error message is displayed.
Venting	manual	Inlet can be vented in "Ready to start" mode by pressing the "Vent" softkey.
	with Stop	The inlet is vented automatically after STOP.
	disabled	Venting of the inlet is locked in the "Ready to start" mode.
Regeneration		Start-Stop - cycle with short range. Intended for the reduction of a raised helium background



Note

With "Venting: no" or "Venting manual" the unintentional venting of vacuum equipment connected to the test connection is prevented. In the case of the option "Venting: no" is the venting operation only available via a modification of the adjustment in menu "Evacuation Time & Vent".

In the case of the option "Venting: manual" is the venting operation possible in the menu "Ready to Start" (→ see Chapter 6.1) with the "Vent" softkey.

Regeneration

Select

Setup ⇒ *User Settings* ⇒ *Monitoring Functions* ⇒ *Evacuation Time & Vent* ⇒ *Regeneration*

The "Regeneration" is an automated Start-Stop - cycle intended for the reduction of a raised helium background. This function can only be successful activated in the setting "Venting: with STOP".

You can deactivate the "Regeneration" in general with the STOP key or with STOP in the "Regeneration" menu.

An active regeneration will be announced in the display.

The regeneration stops after 60 minutes automatically.

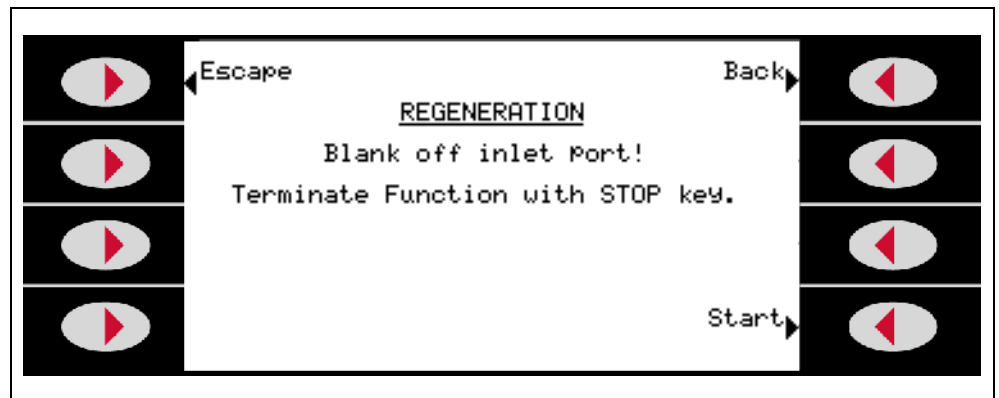

Fig. 6-49 Regeneration menu

With "Start" you start the following action:

Start, Stop with venting

Start, Stop with venting

and so on.

6.4.4.6.6 Calibration Request

Select
 Setup ⇒ User Settings ⇒ Monitoring Functions ⇒ Calibration Request

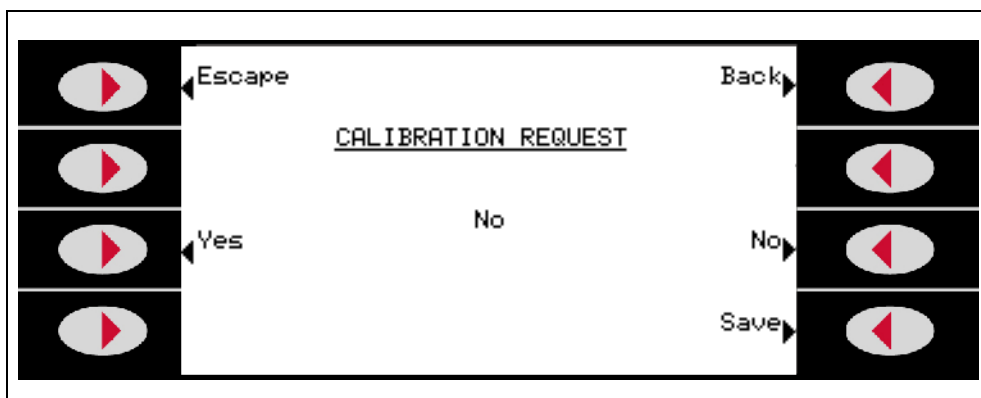

Fig. 6-50 View of the "Calibration request" setting in the display

- Select the desired option with the softkeys on the right and left of the screen.
- Save the new value with "Save" or
- Go back one level with "Back" or to the measured value or ready to start display with "Escape".

Option	Description
yes	The calling for calibration comes up 30 minutes after switching the machine on or when the temperature of the leak detector has changed more than 5°C since it was calibrated the last time.
no	The calling for calibration does not come up.

6.4.5 Calibration Settings

Select
 Setup ⇒ Calibration Settings

In this parameter group settings for the calibration but not the calibration itself are made.

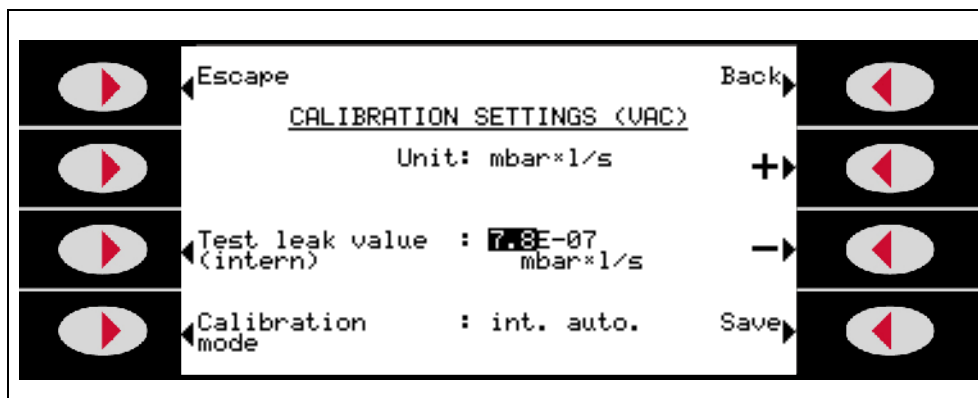

Fig. 6-51 Calibration settings

Option	Value range (Min. / Max.)	Description
Unit	e.g. mbar*l/s	The unit for the test leak value. For internal test leak fixed at mbar*l/s.
Test leak value (internal/external)		Test leak value in selected unit. Depending on the selected calibration mode, this is either an external or an internal test leak.
Calibration mode	int. auto.	Internal automatic calibration mode
	int. man.	Internal manual calibration mode, i.e. the signal stability must be confirmed manually.
	external	External calibration mode

6.4.6 Information

Select
Setup ⇒ Information

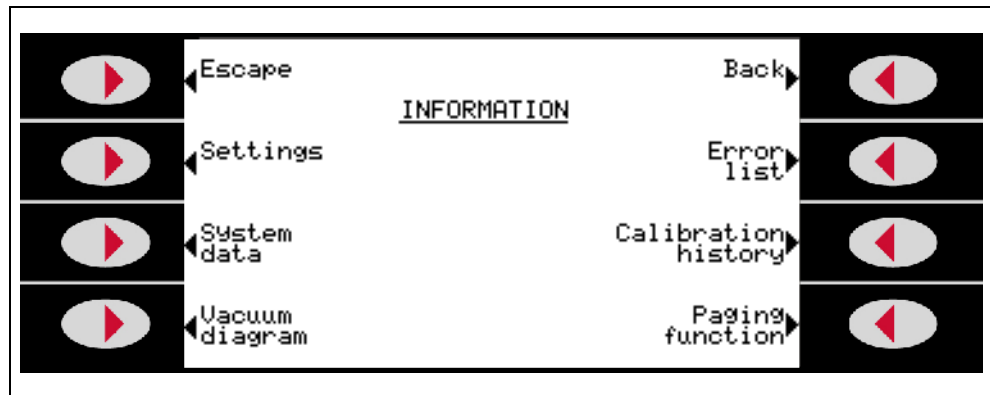

Fig. 6-52 Information menu

6.4.6.1 Settings

Select
Setup ⇒ Info ⇒ Settings

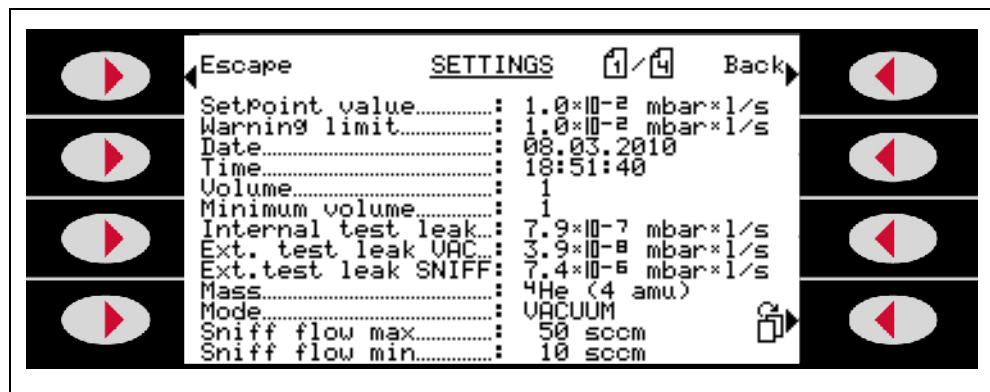

Fig. 6-53 Settings menu

6.4.6.2 System Data

Select
Setup ⇒ Info ⇒ System Data

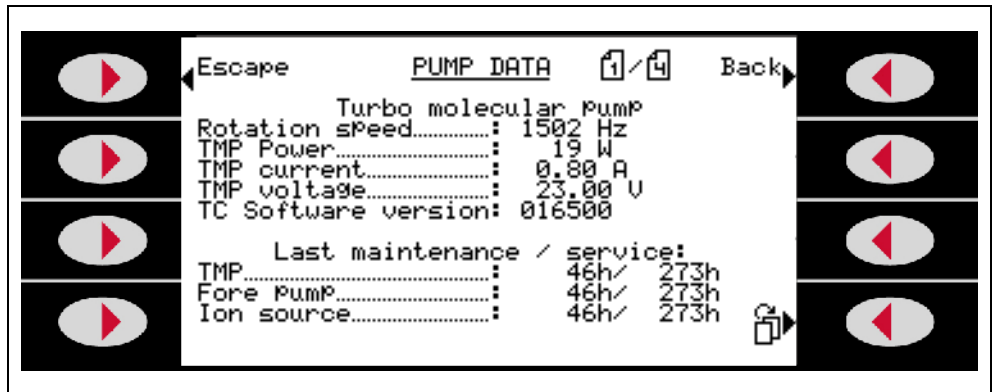

Fig. 6-54 System data (page 1/4 pump data)

6.4.6.3 Vacuum System

Select
Setup ⇒ Info ⇒ Vacuum System

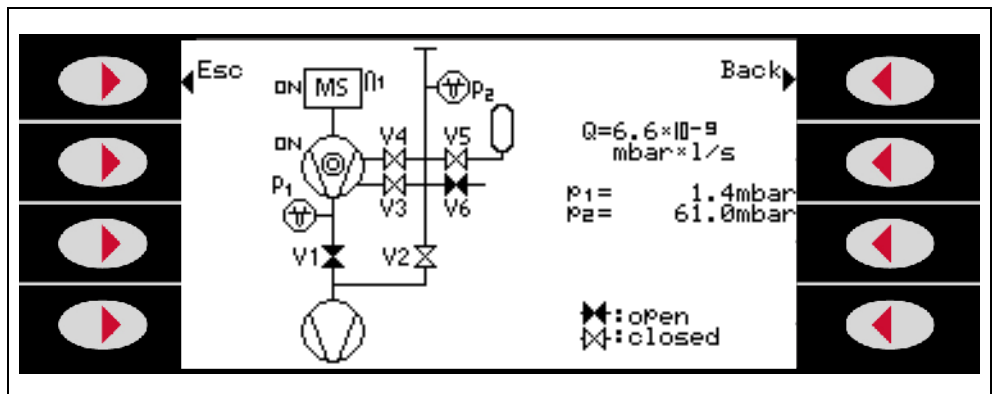

Fig. 6-55 Vacuum system

6.4.6.4 Error List

Select
Setup ⇒ Info ⇒ Error List

Date	Time	No.	Remark
10.03.10	11:52	E042	Emission Off (P1 to...
10.03.10	11:51	E022	Nominal value of th...

Fig. 6-56 Error list

6.4.6.5 Calibration History

Select
Setup ⇒ Info ⇒ Calibration History

Date	Time	CF	High	Low	Cnt.
27. Jan. 2010	09:35	int 4He	1.2	1.0	1.0
26. Jan. 2010	13:11	int 4He	1.2	1.1	1.1
26. Jan. 2010	11:58	int 4He	1.2	1.2	1.2
16. Dec. 2009	11:51	ext 4He	0.9	0.7	0.7
16. Dec. 2009	10:55	man 4He	1.3	1.1	1.1
16. Dec. 2009	10:54	int 4He	1.3	1.2	1.2
16. Dec. 2009	10:51	man 4He	1.2	1.2	1.2
16. Dec. 2009	10:37	man 4He	1.2	1.1	1.1
16. Dec. 2009	10:26	man 4He	1.2	1.0	1.0
16. Dec. 2009	10:21	int 4He	1.3	1.2	1.2
16. Dec. 2009	10:18	ext 4He	0.9	0.7	0.7
16. Dec. 2009	10:16	int 4He	1.3	1.1	1.1

Fig. 6-57 Calibration history

6.4.6.6 Paging function remote control RC 500 WL

Select

Setup ⇒ Info ⇒ Paging function

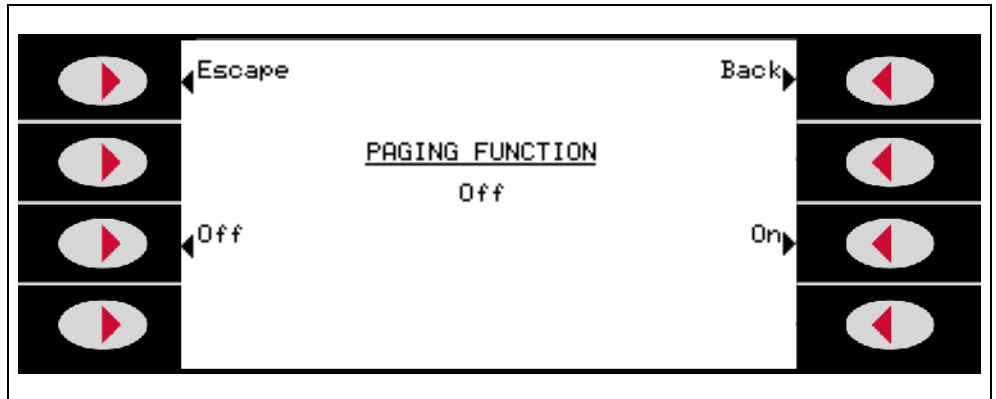

Fig. 6-58 Paging function

A wireless remote control RC 500 WL must be installed and be switched on.

With the paging function the remote control RC 500 WL lets itself locate and assign acoustically from the leak detector.

Pressing the button „On“ in the menu „Paging function“ lets an acoustic signal sound at the remote control RC 500 WL.

Press the button „Off“ to switch off the acoustic signal.

6.4.7 Maintenance and Service

Select
Setup ⇒ *Maintenance & Service*

The maintenance menu can only be chosen when the maintenance was enabled under "setup - access control - maintenance enabled".

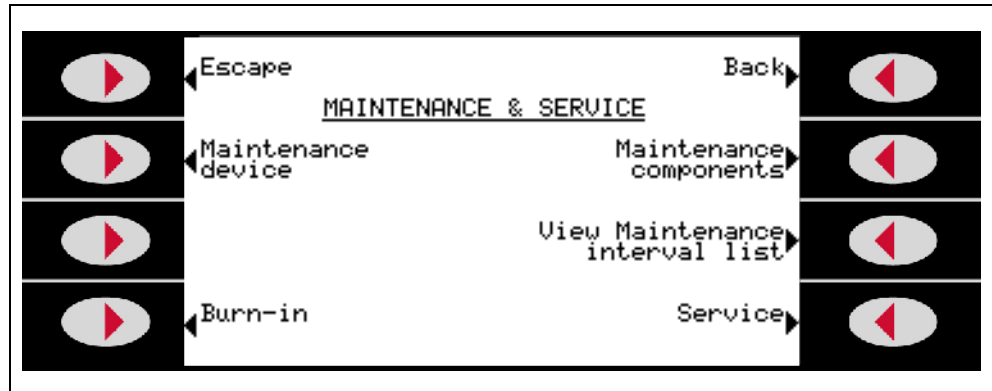

Fig. 6-59 Maintenance and service

6.4.7.1 Maintenance device

Select
Setup ⇒ *Maintenance & Service* ⇒ *Maintenance device*

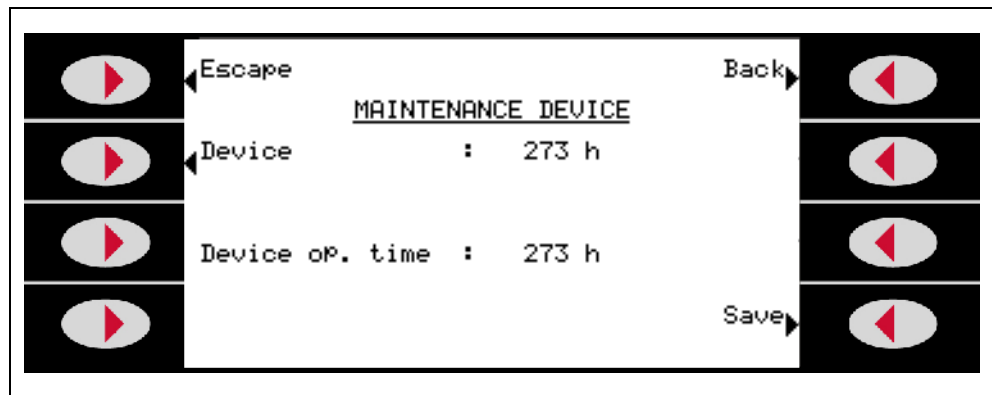

Fig. 6-60 Maintenance interval counter

Press the button "Device" to reset the device maintenance interval counter.

6.4.7.2 Burn In

Select

Setup ⇒ Maintenance & Service ⇒ Burn-In

The "Burn-in" is an automated Start-Stop - cycle.

This function can only be successful activated in the setting "Venting: with Stop".
See Chapter 6.4.4.6.5.

An active "Burn-in" will be announced in the display. You can deactivate the "Burn-in" with STOP in the "Burn-in" menu or with the STOP key.

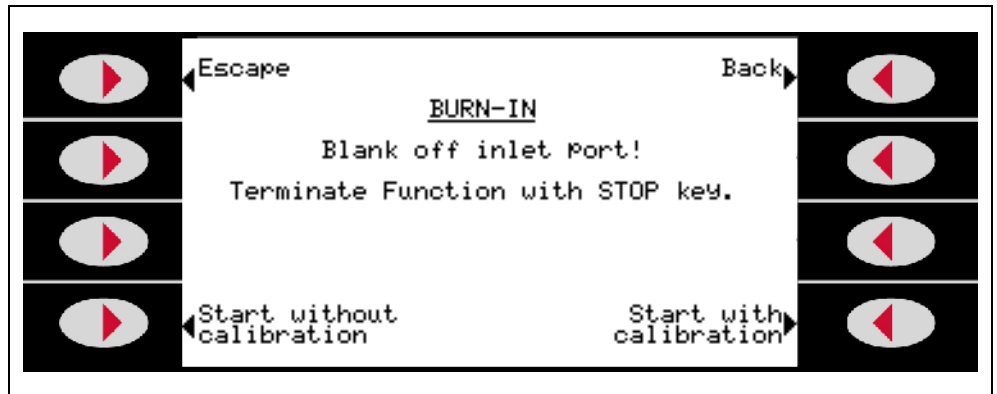

Fig. 6-61 Burn in

Start with calibration	Starts the following operation: Calibrate, start, stop Vent, start, stop Vent, start, stop Vent, start, stop Vent, start, stop Calibrate, start, stop etc.
Start without calibration	Starts the following operation: Vent, start, stop etc.

6.4.7.3 Maintenance Interval Components

Select
Setup ⇒ Maintenance & Service ⇒ Maintenance Components

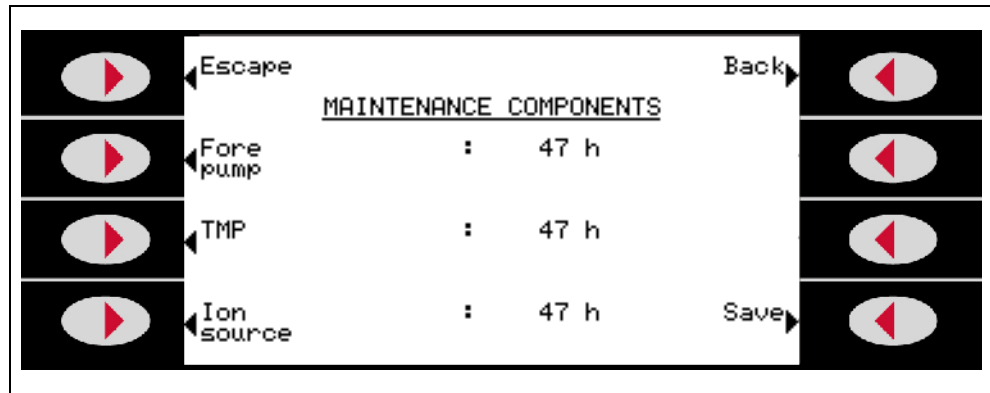

Fig. 6-62 Maintenance components

Under "maintenance components" the current operating hours of the components fore pump, turbo pump and ion source are shown since the last maintenance was accomplished. After each maintenance the counter can be reset. This leads to a new entry in the list of maintenance intervals.

6.4.7.4 Maintenance List

Select
Setup ⇒ Maintenance & Service ⇒ Maintenance List

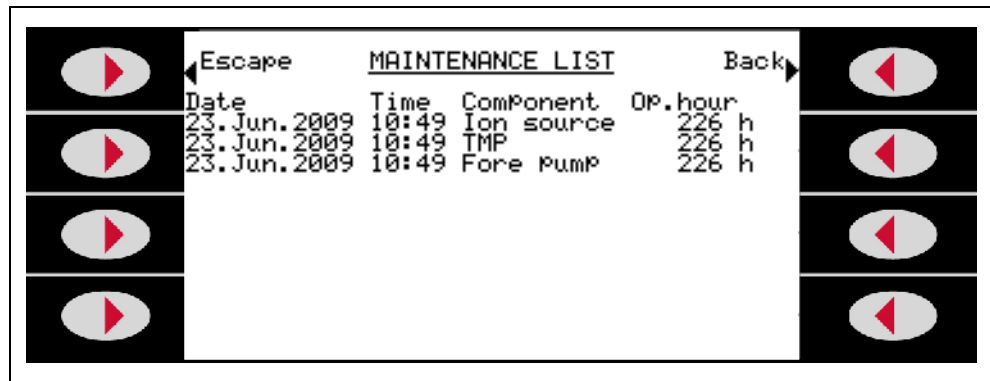

Fig. 6-63 Maintenance list

Date and time of the maintenance are shown under "show list of maintenance intervals". So are the operating hours of the components. This data are collected from one maintenance to the next.

6.4.7.5 Service

Select
Setup ⇒ Maintenance & Service ⇒ Service

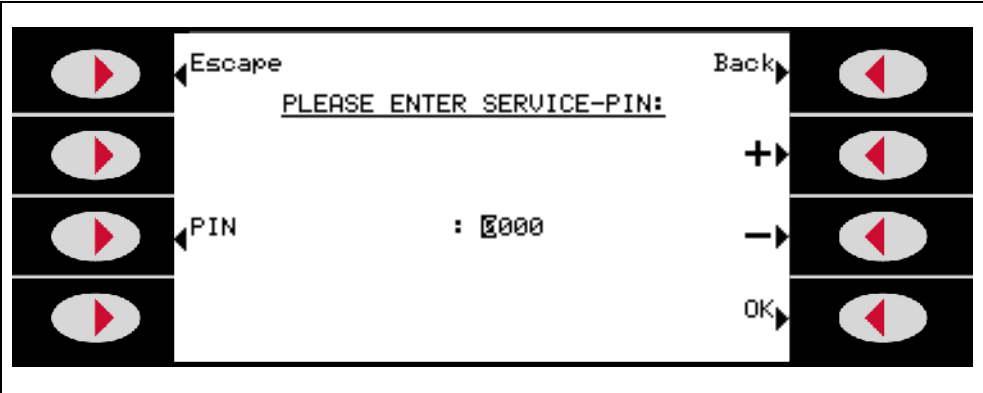

Fig. 6-64 Access with service PIN

The access to the menu "Service" is only possible with a Service-PIN. Please enter the Service-PIN.

6.5 Calibration Vacuum Method



Note

The instrument must have warmed up for at least 20 minutes for optimum calibration.

Please observe the recommended test interval of the used test leak!

See quality test certificate: Test leak

In the vacuum mode the calibration of the SmartTest can be carried out with an internal or external test leak. The internal calibration is only possible with mass 4.

Internal test leak

The calibration with the internal test leak can be carried out in two ways (see also chapter 6.4.5):

- **Automatic internal:**
Serves for calibration with the internal test leak without volume at test connection. The test connection must have a blind flange for this.
- **Manual internal:**
Serves for calibration with the internal test leak with presence of volume at the test connection.
A stable measuring signal must be confirmed with the "Signal stable" softkey.

External test leak

At **test leak: external** (see Chapter 6.4.5) the prompt appears:

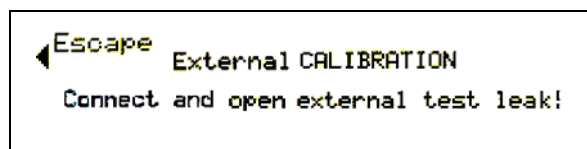

Fig. 6-65



- Is the displayed value equal to the value on the test leak rating plate? Change if necessary! (if not see Chapter 6.4.5)
- Connect the test leak.
- The valve of the test leak must be open.
- Confirm with OK.

Fig. 6-66

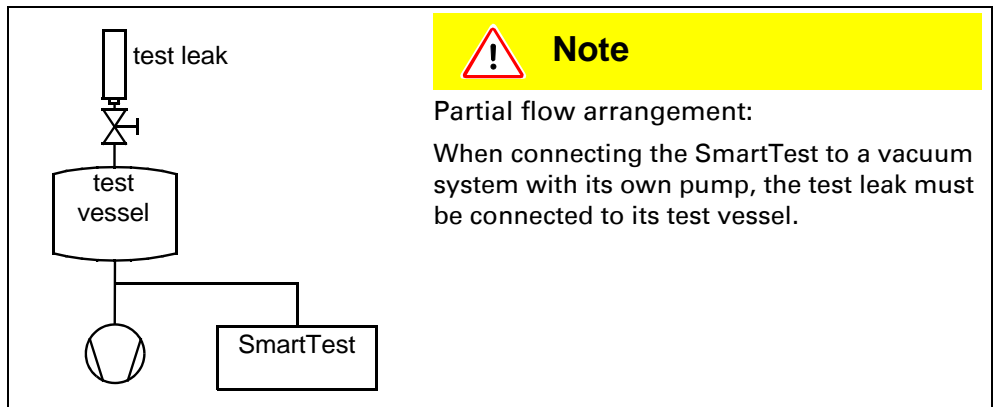

Fig. 6-67

Calibration run

The calibration runs through the following sequence:

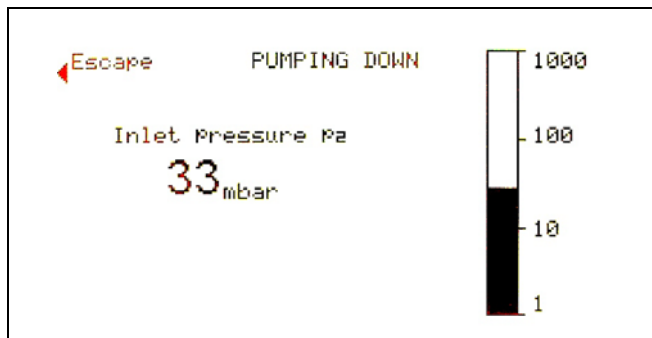

Fig. 6-68

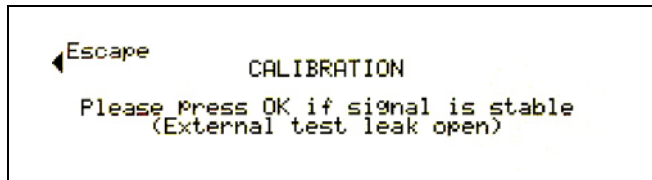

Fig. 6-69

In calibration with an external test leak or an internal test leak in the "Manual internal" mode, the stability of the signal must be confirmed with the "OK" softkey.

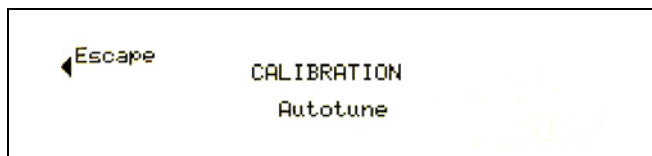

Fig. 6-70

```
◀Escape      CALIBRATION
              Please wait...
              (External test leak open)
              Twin-Flow high
```

Fig. 6-71

```
◀Escape      CALIBRATION
              Please wait...
              (External test leak open)
              Twin-Flow low
```

Fig. 6-72

```
◀Escape      CALIBRATION
              Please wait...
              (External test leak open)
              Counter flow
```

Fig. 6-73

In calibration with an external test leak the prompt appears:

```
◀Escape
              Please close test leak!
```

Fig. 6-74

- Close test leak valve

```
◀Escape      CALIBRATION
              Please wait...
              (External test leak closed)
              Twin-Flow high
```

Fig. 6-75

```
◀Escape      CALIBRATION
              Please Press OK if signal is stable
              (External test leak closed)
```

Fig. 6-76

- Wait 5 minutes with test gas H₂
- Confirm with OK

In calibration with an external or internal test leak in the "Manual internal" mode, the stability of the signal must be confirmed with the "ok" softkey.

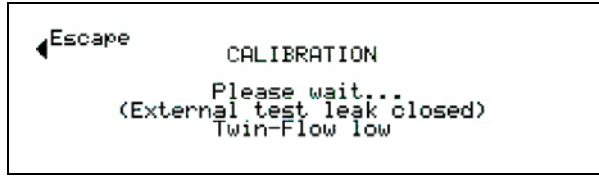

Fig. 6-77

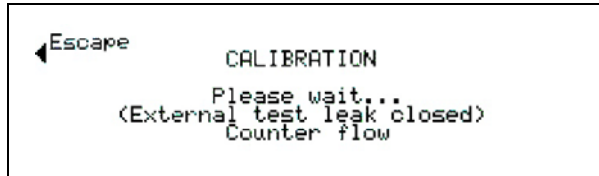

Fig. 6-78

The result is displayed at the end of the calibration process.

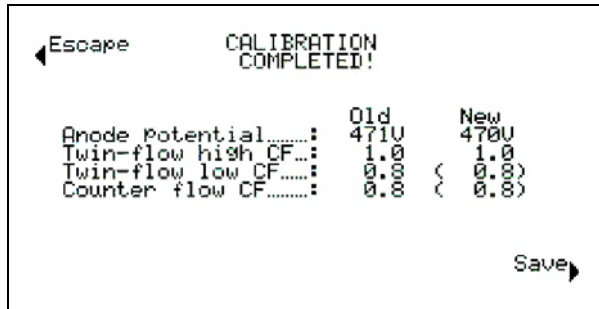



Fig. 6-79

Usual values calibration factor for ⁴ He:	Twin-Flow™	0.1 ... 10
	Counter Flow	0.5 ... 30

Values between 0.1 and 100 are possible. A factor inside of brackets means that the value of the test leak is too low for this measurement range. The factor was calculated with an intermediate factor from the next sensitive measurement range.

If you:

- accept the result, press "Save" to save the new calibration values
- do not accept the result, press "Escape" to keep the old values.



Note

If the usual values cannot be achieved despite several attempts, please contact your nearest Pfeiffer-Vacuum service point.

6.6 Calibration Sniffing Method



Note

The instrument must have warmed up for at least 30 minutes for optimum calibration.

Please observe the recommended test interval of the used test leak!

See quality test certificate: Test leak

Press "Calibration" in the **Ready to start** menu to start calibration.

The prompt appears:

```
←Escape  EXTERNAL CALIBRATION  
Sniff external test leak!
```

Fig. 6-80



- Is the value equal to the value on the test leak rating plate? Change if necessary! See Chapter [6.4.5](#).
- Hold the sniffing probe against the test leak.
- Confirm this with START or with the key on the probe.

Fig. 6-81 Sniffing external test leak

Calibration run

The calibration runs through the following sequences:

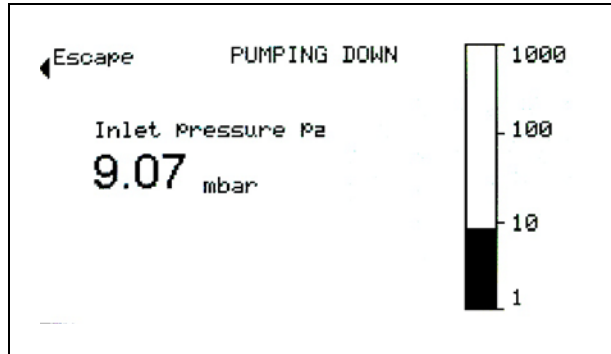

Fig. 6-82

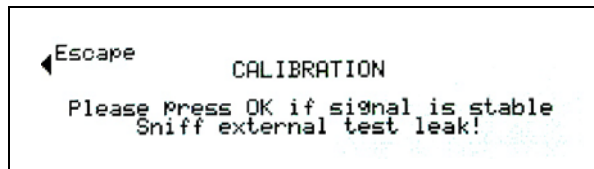

Fig. 6-83

The stability of the signal must be confirmed with the "OK" softkey.

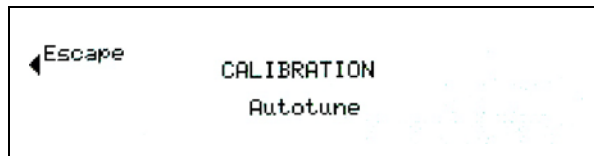

Fig. 6-84

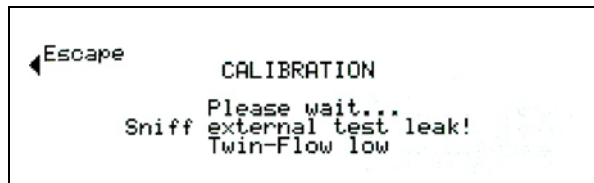

Fig. 6-85

The prompt now appears:

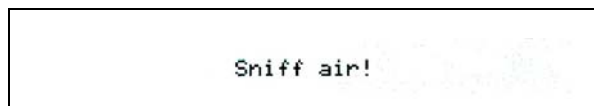

Fig. 6-86

- Remove the sniffing probe from the test leak.
- Confirm with OK or with the key on the probe.

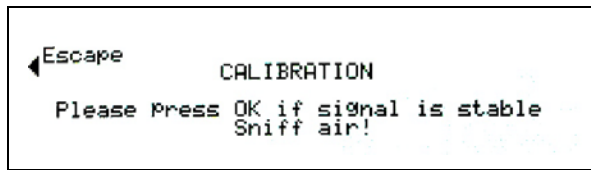

Fig. 6-87

The result is displayed at the end of the calibration process.

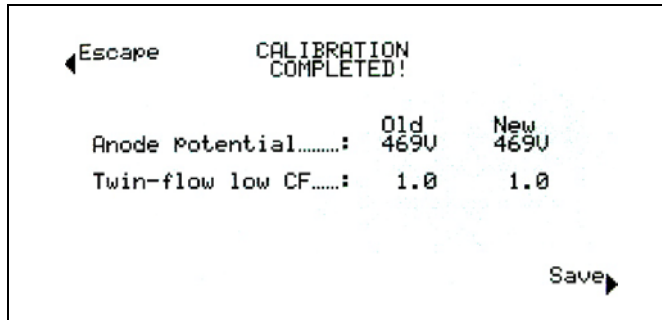

Fig. 6-88

The usual value calibration factor CF for ^4He is: 0.1 ... 10.

If you:

- accept the result, press "**Save**" to save the new calibration values
- do not accept the result, press "**Escape**" to keep the old values.



Note

If the usual values cannot be achieved despite several attempts, please contact your nearest Pfeiffer-Vacuum service point.

6.7 Measuring the Internal Test Leak

This function is only available in the vacuum mode with mass 4.
After running up the instrument the display changes to Ready to start!

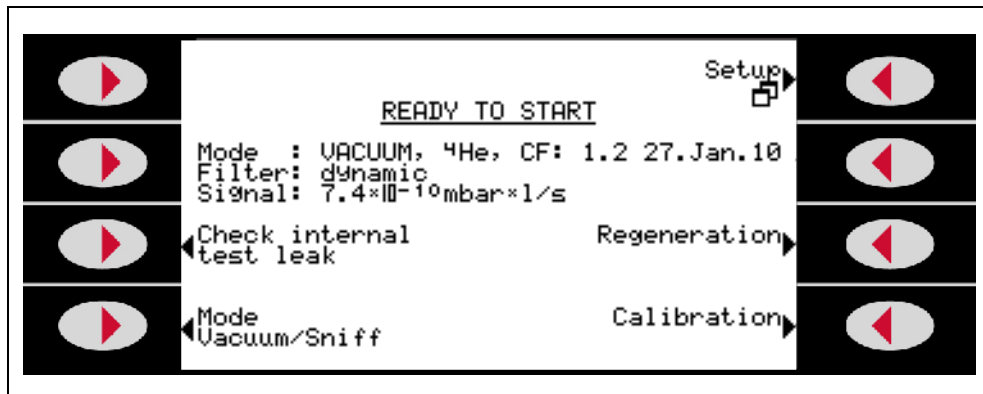

Fig. 6-89 Ready to start

Softkey "Test internal leak" leads to sub-menu:

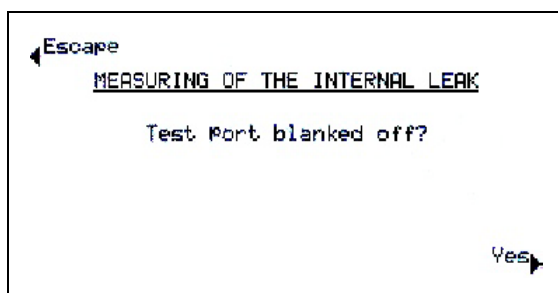

Fig. 6-90

The test connection must have a blank flange!
Confirm with "Yes".

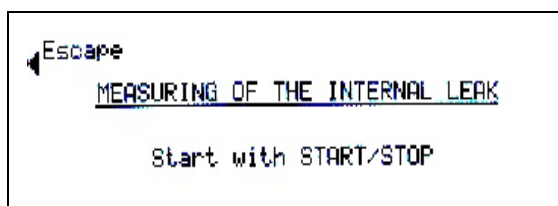

Fig. 6-91

Activating the "Start key" leads to evacuation and starting of the test leak measurement.

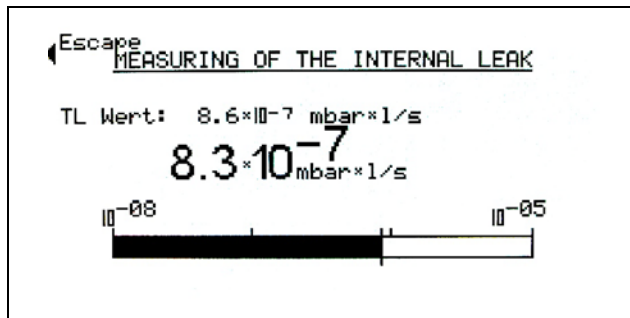

Fig. 6-92

The display also shows the default value of the internal test leak in addition to the measured test leak value: e.g.: TL: 8.3E-07 mbar/s.

Softkey "Escape" always returns you to the menu: Ready to start



Note

Matching of the measured value of the internal test leak and the default value of the internal test leak does not mean that the measuring system is absolutely accurate if the internal test leak was used for calibrating the leak detector.

The display of the internal test leak may only be used as a reference!

Accurate measurements require calibration with an external test leak. See Chapter 6.5.

7 Errors

Errors are displayed by warnings and malfunction messages. Warnings point at a problem but you usually still can measure during that time. Measuring is no longer possible when malfunction messages are displayed.

Warnings and malfunction messages are signaled by an audible alarm. It's frequency is changing between 500Hz and 1200Hz every 400ms. Additionally one of the following messages is displayed:

7.1 Malfunction Messages

Malfunction messages no.		Displayed message	Description and possible remedy of cause
Display	Pfeiffer Protocol		
E21	E128	Nominal value of the anode potential is too high!	<ul style="list-style-type: none"> • Suppressor voltage affected by a short-circuit. • MSV is defective.
E22	E133	Suppressor voltage reference value too high!	<ul style="list-style-type: none"> • Brief increase in pressure in the mass spectrometer. • Valve contaminations cause high mass spectrometer pressure. • The anode voltage is short circuited. • The nominal value for the anode voltage is too high. The anode voltage is limited to 1,200 V.
E24	E125	24V voltage at MSV board is too low!	<ul style="list-style-type: none"> • Fuse F1 on the MSV card is blown. • MSV card defective • 24 V supply voltage from main power supply unit too heavily stressed or faulty.
E25	E134	Filament current is too high!	<ul style="list-style-type: none"> • MSV card defective.
E26	E135	Filament current is too low!	<ul style="list-style-type: none"> • MSV card defective • Defective ion source connector or cable.
E27	E145	Emission fail	<ul style="list-style-type: none"> • Air in rush • Valves contaminated • Failure of a filament during measurement
E28	E138	Emission for both filaments can not be switched on!	<ul style="list-style-type: none"> • Both filaments defective. Replace ion source. • Defective ion source connector. • MSV card defective
E29	E131	The anode potential exceeds its nominal value by over 10%!	<ul style="list-style-type: none"> • MSV is defective. • MC 68 defective
E30	E132	The anode potential has dropped below its nominal value by over 10%!	<ul style="list-style-type: none"> • Brief increase in pressure in the mass spectrometer. • MSV is defective. • MC 68 defective

Malfunction messages no.		Displayed message	Description and possible remedy of cause
Display	Pfeiffer Protocol		
E31	E126	Anode-cathode voltage is too high!	Anode-cathode voltage is greater than $U > 130 \text{ V}$. <ul style="list-style-type: none"> MSV is defective.
E32	E127	Anode-cathode voltage is too low!	Anode-cathode voltage is less than $U < 30 \text{ V}$. <ul style="list-style-type: none"> Fuse F4 MSV card defective MSV is defective.
E33	E129	Suppressor potential too high!	Suppressor potential is greater than 363V. <ul style="list-style-type: none"> MSV is defective.
E34	E130	Suppressor potential too low!	Suppressor potential is less than $U < 297 \text{ V}$. <ul style="list-style-type: none"> Short-circuit in the suppressor line. MSV is defective. High ohmic short-circuit in the ion catcher.
E35	E159	24V of the OPTION socket is too high	The voltage 24 V for the external outputs I/O; RS 485; Gauge Head is too high. ($U > 30 \text{ V}$) <ul style="list-style-type: none"> Check the external feed of the 24 V outputs. Power supply unit defective
E36	E120	24V of the OPTION socket is too low	The voltage 24 V for the external outputs I/O; RS 485; Gauge Head is too low. ($U < 20 \text{ V}$) <ul style="list-style-type: none"> Fuse F1 on I/O card defective. Power supply unit defective
E37	E122	24V of the remote control is too low ($< 20 \text{ V}$)	The voltage 24 V for the external outputs RC; fan 1+2 are too low. ($U < 20 \text{ V}$) <ul style="list-style-type: none"> Fuse F2 on I/O card defective. Power supply unit defective
E39	E044	Temperature at electronic unit is too high ($> 60^\circ \text{C}$)	<ul style="list-style-type: none"> The ambient temperature is too high. Unfavourable position of leak detector. (heat build-up) Fan failed. Air filter too heavily contaminated. Temperature sensor defective.
E41	E141	TMP frequency is too low!	The nominal speed (1450 Hz) of the turbo molecular pump SplitFlow 80 was not reached within 5 min. <ul style="list-style-type: none"> Fore pressure of the SplitFlow 80 is too high. Turbo molecular pump SplitFlow 80 is defective. Drive electronics TC 110 is defective.
E42	E148	Emission Off (p1 too high)	<ul style="list-style-type: none"> Air in rush Valve V1 leaking.

Malfunction messages no.		Displayed message	Description and possible remedy of cause
Display	Pfeiffer Protocol		
E 43	E 149	Emission Off (p2 too high)	The emission is switched off during normal operation of the leak detector when: <ul style="list-style-type: none"> • in CF P2 > (pressure limit CF + 5 mbar) or • in TFL P2 > (pressure limit TFL + 1 mbar) or • in TFH P2 > (pressure limit TFH + 0,1 mbar)
E49	E166	Output voltage of the external pressure gauge too high.	<ul style="list-style-type: none"> • Sensor of the pressure measuring point defective • Electronics pressure measuring point defective
E50	E160	Output voltage of the external pressure gauge too low.	<ul style="list-style-type: none"> • Check cable to ext. gauge • Sensor of the pressure measuring point ground connection • Electronics pressure measuring point defective
E51	E161	Identifying resistor of external pressure gauge too low.	The rated resistance of the ext. pressure measuring point too low. <ul style="list-style-type: none"> • Check cable to ext. gauge • Wrong ext. pressure measuring point used • Electronic pressure measuring point defective • Input short-circuited
E52	E162	Inlet pressure p2 too low!	The output voltage of the pressure measuring point P2 is too low. <ul style="list-style-type: none"> • Cable to Pirani sensor broken • Pirani sensor defective • Sensor electronics I/O card defective
E54	E163	Foreline pressure p1 too low!	The output voltage of the pressure measuring point P1 is too low <ul style="list-style-type: none"> • Cable to Pirani sensor • Pirani sensor defective • Sensor electronics I/O card defective
E56	E165	p1 > 10mbar after runup	The fore-vacuum pressure P1 after 5 min. in run up is > 10 mbar <ul style="list-style-type: none"> • Backing pump defective • Leaks in the vacuum system • Valve V1 does not open
E60	E001	TMP frequency too high (E001)!	Rated speed of 1500 Hz exceeded by 10%. <ul style="list-style-type: none"> • Check connecting cable, restart leak detector • TC 110 defective
E61	E002	TMP power supply faulty (E002)!	Error detected in the power supply unit TC 110. <ul style="list-style-type: none"> • Power supply unit defective

Malfunction messages no.		Displayed message	Description and possible remedy of cause
Display	Pfeiffer Protocol		
E62	E006	TMP acceleration time too high (E006)!	Speed of the SplitFlow 80 is 15 min. after starting below the speed switching point < 1200 Hz. <ul style="list-style-type: none"> • Turbo pump bearing damage • TC 110 defective
E63	E008	TMP connection TC to pump faulty (E008)!	TMP connection between TC 110 and SplitFlow 80 defective <ul style="list-style-type: none"> • Check proper assembly of TC 110 on SplitFlow 80 • TC 110 defective
E64	E015	TMP controller faulty (E015)!	TMP controller TC 110 detected as defective. <ul style="list-style-type: none"> • Exchange TC 110
E65	E021	TMP wrong resistor (E021)!	TMP controller detects wrong pump rated resistance <ul style="list-style-type: none"> • Exchange SplitFlow 80
E66	E037	TMP motor control faulty (E037)!	The control of the SplitFlow 80 motor is defective. <ul style="list-style-type: none"> • Exchange SplitFlow 80 • Exchange TC 110
E68	E140	No communication with turbo pump.	No communication via the RS 485 between TC 110 and MC 68 control card <ul style="list-style-type: none"> • Connection faulty or not plugged TC 110 – wiring plane • TC 110 defective • MC 68 defective
E70	E123	The offset voltage of the pre-amplifier is too high. (>5mV)	<ul style="list-style-type: none"> • The pre-amplifier is defective. • Defective supply voltage pre-amplifier
E71	E25	TMP Temperature Control faulty	<ul style="list-style-type: none"> • Temperature sensor short circuit
E72	E26	TMP Temperature Sensor faulty	<ul style="list-style-type: none"> • Temperature sensor broken

7.2 Warnings

Warnings no.		Displayed message	Description and possible remedy of cause
Display	Pfeiffer Protocol		
W69	E167	TMP-Fault	<ul style="list-style-type: none"> Unknown error code
W101	W064	Real time clock reset! Please enter date and time!	<p>Real-time clock reset. Please re-enter the date and time.</p> <ul style="list-style-type: none"> Battery on MC 68 control circuit board discharged or defective MC 68 changed
W102	W088	Please recalibrate!	<p>The automatic calibration prompt is activated and one of the following conditions is fulfilled.</p> <ul style="list-style-type: none"> 30 minutes have expired since switching on the leak detector. The pre-amplifier temperature has changed by more than 5°C since the last calibration. The mass setting has changed. The filament has been switched over. <p>After the confirmation of this warning a "warning triangle" remains in the "Ready to start" menu, which signals the existence of this interruption. See Chapter 6.2. The "warning triangle" disappears as recently as this interruption will be corrected.</p>
W103	W062	Flow through capillary is too low	<ul style="list-style-type: none"> Filter is filter tip blocked Sinter filter in filter tip soiled. Capillaries blocked by dirt. Lower flow limit set incorrectly. <p>After the confirmation of this warning a "warning triangle" remains in the "Ready to start" menu, which signals the existence of this interruption. See Chapter 6.2. The "warning triangle" disappears as recently as this interruption will be corrected.</p>
W104	W065	Capillary broken	<p>The flow of the sniffer pipe is monitored in the sniffing mode. If the flow exceeds the set maximum, the gas flow through the capillaries is too high. The maximum flow can be set by the menu within certain limits. The factory setting is 40 sccm.</p> <ul style="list-style-type: none"> Capillary broken or torn Upper flow limit set incorrectly <p>After the confirmation of this warning a "warning triangle" remains in the "Ready to start" menu, which signals the existence of this interruption. See Chapter 6.2. The "warning triangle" disappears as recently as this interruption will be corrected.</p>
W105	W066	Global Reset!	A global reset has been performed.

Warnings no.		Displayed message	Description and possible remedy of cause
Display	Pfeiffer Protocol		
W106	W067	Default Settings loaded!	The factory settings have been loaded by the instrument software.
W107	W090	Service interval expired!	<ul style="list-style-type: none"> • Perform service backing pump • Perform service SplitFlow 80. <p>After the confirmation of this warning a "warning triangle" remains in the "Ready to start" menu, which signalizes the existence of this interruption. See Chapter 6.2. After maintaining the leak detector the service interval can be set back under "maintenance & service" (device - maintenance interval)</p>
W108	W091	Zero disabled!	The "Zero" function has been locked in the setting menu but was operated via the PLC input.
W109	W068	Amplifier signal too high (>10V)!	<p>The pre-amplifier signal is overmodulated in the most insensitive measuring range.</p> <ul style="list-style-type: none"> • Pre-amplifier defective • Mass spectrometer heavily soiled
W120	W069	Time-out during calibration!	Pressure threshold for following measuring range is not reached within the set time limit. The time limit is specified by the set maximum evacuation time in the menu.
W121	W070	Calibrated leak signal too small!	<ul style="list-style-type: none"> • The test leak used for the calibration is too small. • The external test leak valve is not open or defective. • Internal test leak defective.
W122	W092	Cal signal not stable!	<ul style="list-style-type: none"> • Leak rate signal too small and noisy • Internal test leak defective • Backing pump with heavily unstable end pressure
W123	W071	Peak out of tuning range!	<ul style="list-style-type: none"> • Leak rate signal was unstable during the mass adjustment. Re-calibrate. • Check internal test leak and repeat the calibration with an external test leak.
W124	W072	Signal difference between opened and closed calibrated leak too small!	<ul style="list-style-type: none"> • Internal test leak defective. • The external test leak valve is defective or not closed. • The external test leak value is too small.
W125	W073	Calibration factor too low!	<p>The calculated calibration factor is outside the permissible range (< 0.1). The old factor is retained.</p> <ul style="list-style-type: none"> • The test leak is defective. • The entered leak rate value for the test leak is much too small. • The conditions necessary for calibration have not been satisfied.

Warnings no.		Displayed message	Description and possible remedy of cause
Display	Pfeiffer Protocol		
W126	W074	Calibration factor too high!	<p>The calculated calibration factor is outside the permissible range (> 100). The old factor is retained.</p> <ul style="list-style-type: none"> • The test leak is defective or empty. • The entered test leak value for the test leak is too great. • Mass spectrometer soiled and insensitive. • The conditions necessary for calibration have not been satisfied.
W130	W060	Preamplifier temperature is too low (<2°C)	<ul style="list-style-type: none"> • The ambient temperature is too low. • The temperature sensor in the pre-amplifier is defective. • Cable pre-amplifier is defective. <p>After the confirmation of this warning a "warning triangle" remains in the "Ready to start" menu, which signalizes the existence of this interruption. See Chapter 6.2. The "warning triangle" disappears as recently as this interruption will be corrected.</p>
W131	W075	Preamplifier temperature is too high (>60°C)	<ul style="list-style-type: none"> • The ambient temperature is too high. • The air filter is soiled. • Heat build-up due to unfavourable position. • Temperature sensor in the pre-amplifier defective. <p>After the confirmation of this warning a "warning triangle" remains in the "Ready to start" menu, which signalizes the existence of this interruption. See Chapter 6.2. The "warning triangle" disappears as recently as this interruption will be corrected.</p>
W132	W063	Temperature at electronic unit is too low (<2°C)	<ul style="list-style-type: none"> • Ambient temperature too low • Temperature sensor defective. <p>After the confirmation of this warning a "warning triangle" remains in the "Ready to start" menu, which signalizes the existence of this interruption. See Chapter 6.2. The "warning triangle" disappears as recently as this interruption will be corrected.</p>
W133	W076	Temperature at electronic unit is too high (>55°C)	<ul style="list-style-type: none"> • The ambient temperature is too high. • Unfavourable position of leak detector. (heat build-up) • Fan failed. • Air filter too heavily contaminated. • Temperature sensor defective. <p>After the confirmation of this warning a "warning triangle" remains in the "Ready to start" menu, which signalizes the existence of this interruption. See Chapter 6.2. The "warning triangle" disappears as recently as this interruption will be corrected.</p>

Warnings no.		Displayed message	Description and possible remedy of cause
Display	Pfeiffer Protocol		
W135	W077	Emission for filament 1 can not be switched on!	<ul style="list-style-type: none"> Filament 1 defective Defective ion source connector or cable. MSV card defective.
W136	W078	Emission for filament 2 can not be switched on!	<ul style="list-style-type: none"> Filament 2 defective Defective ion source connector or cable. MSV card defective.
W140	W079	EEPROM write timeout!	<p>The write command from the MC 68 to the EEPROM was not acknowledged.</p> <ul style="list-style-type: none"> E-EPROM defective. Error on wiring board MC 68 defective.
W141	W080	EEPROM parameter queue overflow!	Software problem. Please contact Pfeiffer Service!
W142	W081	All EEPROM parameter lost! Please check your settings!	<p>EEPROM on wiring plane is empty and was initialized with default values. All parameters must be re-entered or determined.</p> <ul style="list-style-type: none"> If the warning occurs again after switching back the leak detector, the EEPROM on the wiring plane is probably defective. Wrong EEPROM type used. New EEPROM is used.
W143	W082	x EEPROM parameter lost! Please check your settings!	<p>Missing or invalid value of parameters in the EEPROM after switching on the leak detector.</p> <ul style="list-style-type: none"> EEPROM cannot be described. EEPROM defective. MC 68 control circuit board defective Line connection to the EEPROM broken Wrong EEPROM type used
W145	W083	x EEPROM parameter initialized! Please check your settings!	<p>Missing or changed parameter in the EEPROM and new software version number determined.</p> <ul style="list-style-type: none"> A software update has been performed and one or more new parameters determined. The message can be acknowledged in this case. The parameter(s) is (are) automatically initialized.
W151	W084	No bypass valve connected!	<ul style="list-style-type: none"> Connection partial current valve removed Partial current valve selected in the menu but not connected.
W152	W085	No external pressure sensor connected	<p>No external pressure sensor has been detected.</p> <ul style="list-style-type: none"> Ext. gauge head selected in the menu but not connected or cable broken Ext. pressure sensor defective. Rated resistance not detected.

Warnings no.		Displayed message	Description and possible remedy of cause
Display	Pfeiffer Protocol		
W160	W086	Leak rate too high! Switched to Stand-By to prevent contamination!	The monitor function "Contamination protection" is activated and a leak rate above the set limit value has been detected. <ul style="list-style-type: none"> • Serious leak. • Switch off limit value too low. • Alarm delay set too short.
W161	W087	Maximum evacuation time exceeded!	Within the set evacuation time the „measure“ mode has not been reached. <ul style="list-style-type: none"> • Evacuation time is adapted incorrectly to the sample volume. • Sample has a serious leak. • Pressure set point are wrong selected.

By pressing OK you affirm a warning or a malfunction message which then will be adopted to the error list.



Note

If an error should occur which cannot be repaired, please contact your nearest Pfeiffer-Vacuum service point.



Note

Please make use of our service!

In the unlikely event of an error in your leak detector there are various ways to maintain the availability of your plant.

- Have the leak detector repaired on site by the PFEIFFER Service.
- Send the leak detector to the parent company for repair.
- Replace the leak detector with a new one.

Please contact your PFEIFFER representative for details.

7.3 Changing Mains Fuses



Danger

Caution: Mains voltage

Incorrectly fused products may be fatal.

Only use fuses with the values specified above!

- 1 Switch off the instrument and disconnect from the mains.
- 2 Pull out the mains plug.

- 3** Lever open and lift the cover of the fuse holder.

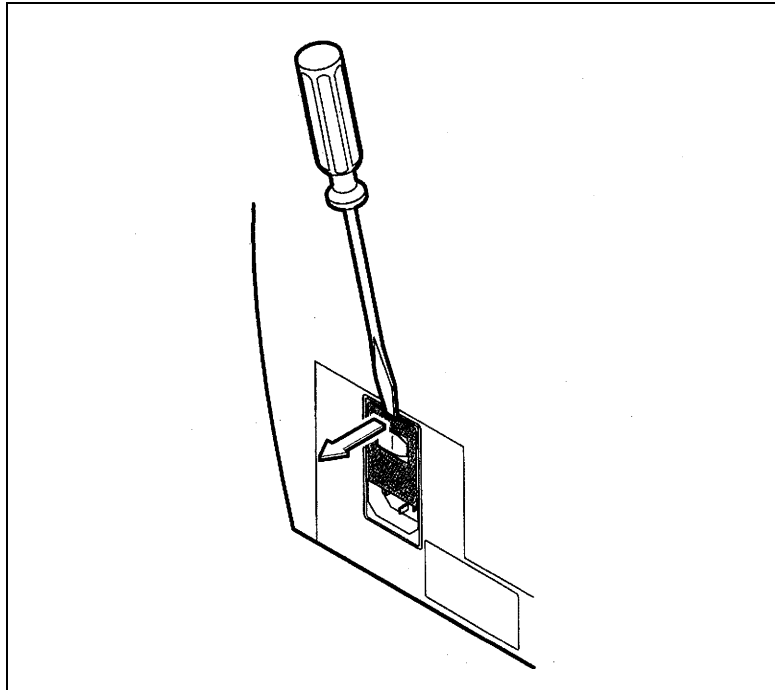

Fig. 7-93 Change the mains fuses (1)

- 4** Remove both fuse holders and replace defective fuses (10.0 A slow blow, 250 V, Ø5 x 20 mm).

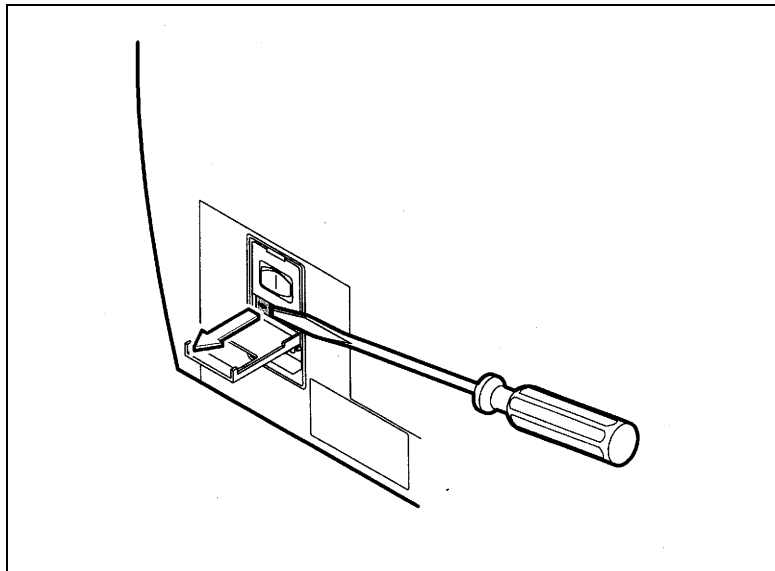

Fig. 7-94

- 5** Snap the fuse holder back together.
6 Close the cover.
7 Reconnect the power cable.

8 Disposal



Danger

Caution: Contaminated parts

Contaminated parts can cause damage to health and the environment.

Find out about possible contamination before starting work. Observe the pertinent regulations and safety precautions when handling contaminated parts.



Warning

Caution: Materials which are harmful to the environment

Products or parts (mechanical and electrical components, operating fluids etc.) can be harmful to the environment.

Dispose of such harmful materials according to local regulations.

Division of the components

After dismantling the product, the components must be divided into the following categories for disposal:

Contaminated components

Contaminated components (radioactive, toxic, caustic, microbiological, etc.) must be decontaminated according to national regulations, separated and disposed of according to their type of material.

Uncontaminated components

These components must be separated according to their type of material and recycled.

Operating fluids

Operating fluids of the backing pump and high vacuum pumps must be disposed of according to the local regulations.

9 Accessories and Consumer Materials

Basic instrument

	Order number
Filter mats (5 pieces)	B 8199 999 EG
Carriage for SmartTest, prepared for fore pump 230 V~, 50 Hz 100 ... 120 V~, 50 ... 60 Hz	PT 445 415 PT 445 416
Transport case for SmartTest	PT 445403
Scratch guard for SmartTest PU mat	PT 445 404
Screw-in flange DN 25 ISO-KF for external backing pump	PT 445 417

Remote control¹⁾

	Order number
Remote control RC 500 WL (wireless)	PT 445 420 -T
Remote control RC 500 (non-wireless)	PT 445 421 -T
Accessories:	
Connecting cable radio transmitter 4m	PT 445 401
Extension cable 8m (cascadable up to a maximum 28 m)	PT 445 402
Radio transmitter (to operate another leak detector)	PT 445 422

¹⁾ technical data see appendix

Sniffing probes

	Order number
Sniffing line with standard tip TP 312 (rigid, 120 mm) LP 503, 3 m LP 505, 5 m LP 510, 10 m	BG 449 207 -T BG 449 208 -T BG 449 209 -T
Sniffing tips TP 385 (385 mm, rigid) TF 312 (120 mm, flexible) TF 385 (385 mm, flexible)	BG 449 216 -T BG 449 217 -T BG 449 218 -T

Bypass-option

	Order number
With main cable and German plug	PT 445 410 -T
With main cable, VL	PT 445 412 -T

Signal tower

	Order number
Signal tower (lamp) green / red for optical leak indication	B 4681 891 KC

External test leaks

	Order number
Calibrated helium vacuum test leak CT 406 1...3x10 ⁻⁶ mbar l/s CT 408 ≈ 10 ⁻⁸ mbar l/s CT 446 10 ⁻⁴ ... 10 ⁻⁶ mbar l/s, adjustable	PT 445 406 B 8116 557 B 8115 580
Calibrated helium sniffing test leak CL 004 10 ⁻⁴ mbar l/s 10 ⁻⁵ mbar l/s 10 ⁻⁶ mbar l/s	BG 447 704 -T BG 447 705 -T BG 447 706 -T
Calibrated H ₂ +He (5%/95%) sniff test leak CL 002A 10 ⁻⁴ mbar l/s (total leak rate) 10 ⁻⁶ mbar l/s (H ₂ leak rate)	BG 449 025A
Helium pistol	BG 512 125 -T

Venting valve

	Order number
Venting valve, 24V DC, G1/8'' for connection to TC 110	PM Z01 290

Appendix

A Remote Control RC 500 WL

Like the instrument operating unit the remote control RC 500 WL is a display operation and control element, measured values of up to 24 hours of recording can be stored in an internal memory.

It offers the advantage of simple wireless operation of the leak detector from a distance of up to 100 m and is also connectable by a cable with the leak detector. (See also operating instructions RC 500 WL / RC 500: IG 0140 BEN.)

The following features are provided.

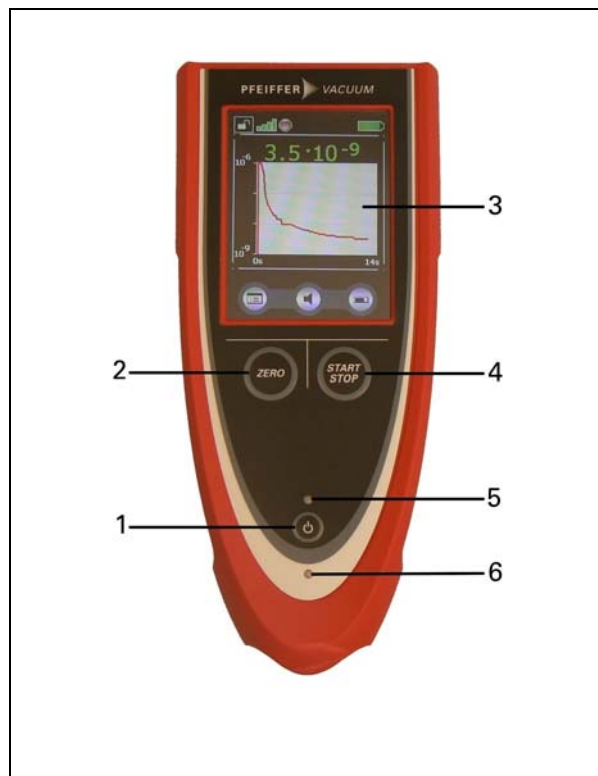

Fig. 10-1 Wireless Remote Control RC 500 WL

- 1** POWER button
Switch on and off the Remote Control RC 500 WL
- 2** ZERO button
ZERO activates the background suppression in measurement mode.
By pressing the button longer than 3 seconds the underground suppression will be deactivated.
- 3** Touch Display
The touch display offers comprehensive features of visualization, operation and configuration. Measured values can be displayed numerically or as a curve. The functions are easy to use with the softkeys.
- 4** START/STOP button
The measuring process of the leak detector is started and stopped with the START/STOP key.

- 5** LED operation
Signals by flashing the operation of the Remote Control.
- 6** LED Charge
Lights up while the battery is being charged.

The Remote Control is an optional accessory and is therefore not included in the standard delivery scope. It can be ordered separately if required with the appropriate accessories (see Chapter 9).

B Interfaces

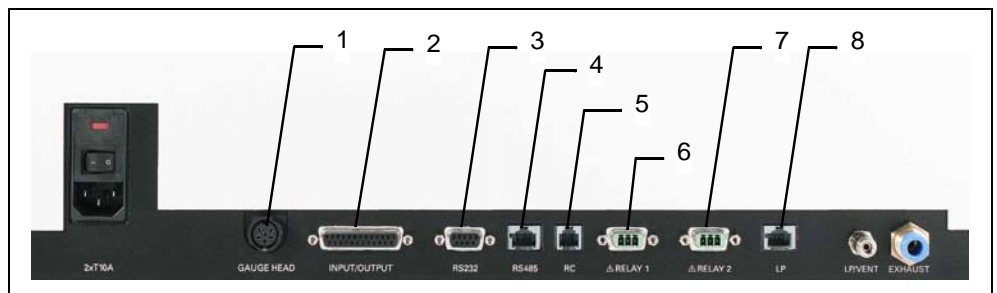

Fig. 10-2

- 1** GAUGE HEAD: Connection for compact gauge heads
- 2** INPUT/OUTPUT: control and output signals
- 3** RS232: connection for computer / printer
- 4** RS485: connection for computer
- 5** RC: remote control or radio transmitter
- 6** RELAY 1: relay contact
- 7** RELAY 2: relay contact
- 8** LP: connection for sniffing probe LP 503, LP 505 or LP 510

Notice All plugs are illustrated looking at the SmartTest from the outside.

GAUGE HEAD

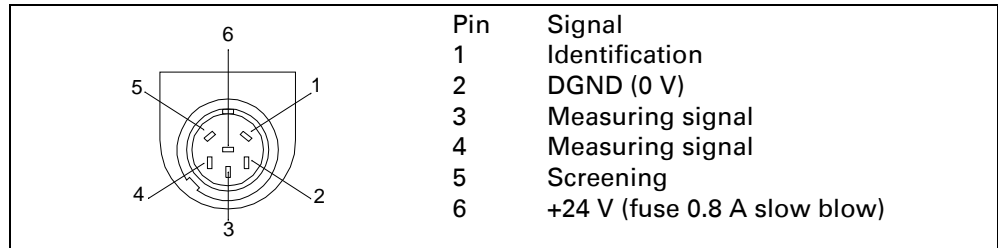

Fig. 10-3

Usable compact gauge heads

	Display Operating unit	Gauge head designation
Linear gauge heads	linear	CMR 261, CMR 262, CMR 263, CMR 264, CMR 271, CMR 272, CMR 273, CMR 274 CMR 275
Compact Capacitance Gauges		
Compact Piezo Gauges	linear	APR 250, APR 260, APR 262, APR 265, APR 266, APR 267
Logarithmic gauge heads	Display Operating unit	Gauge head designation
Compact Pirani Gauges	TPR ¹	TPR 280
Compact Pirani / Capacitance Gauges	PCR 260	PCR 260
Compact FullRange™ CC Gauges	PKR	PKR 251, PKR 261

¹⁾ The pressure value for the gauge head type TPR / PCR is only shown until 1000 mbar. Pressures above 1000 mbar are shown as >1000 mbar.

See [Fig. 10-2/1](#).

INPUT / OUTPUT

Input and output signals, 25-pole, D-Sub, sockets, see [Fig. 10-2/2](#).

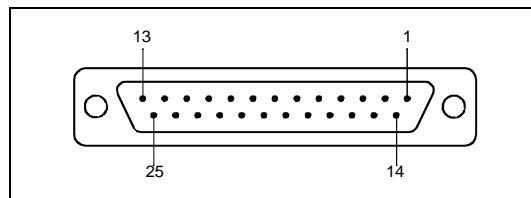

Fig. 10-4 D-Sub plug

Pin	Signal	Explanation
1	CHANNEL 1	Analog output 0 ... 10 V, Ri 3 Ω, function. See 6.4.4.4.1
2	CHANNEL 2	Analog output, data as above. See 6.4.4.4.1
3	AGND	Reference potential analog outputs, galvanically isolated
4		Audio output (headphones or active speaker)
5		Reference potential to audio output
6 ... 13	DI 1 ... 8	Digital inputs, +18 ... 30 V (approx. 5 mA). The functions are activated with the positive edge. Equal rights with the operating unit
6	Start/Stop	Starts the measurement in status "Ready to start" and stops the measurement in status "Ready to measure"
7	Vent	Venting with setting "Venting manual" see chapter 6.4.4.6.5
8	Zero	Function same as ZERO key. ZERO is cancelled if applied longer than 3s.
9	Calibrate	Starts calibration or to confirm "Calibration Acknowledge" (PIN 19)
10	PARA 2	Activate: load parameter set 2 Deactivate: load parameter set 1
11	Bypass	Response "Bypass option available"
14	DGND	Reference potential of the digital inputs, galvanically isolated
15 22	DO1 ... 8	Digital outputs (not separated galvanically), active 24 V ± 10%, passive at DGND (0 V) maximum permissible current: 800 mA for all outputs together All outputs are active for approx. 1 s when switching on
15	Ready to start	Active when SmartTest is ready to pump off the test volume
16	Ready to measure	Active when SmartTest measures, i.e. in the state counter flow, Twin-Flow™ low and Twin-Flow™ high
17	Leak	Active when the alarm threshold is enabled and was exceeded, passive below 90% of this value
18	Error	Active in error state
19	Calibrate Acknowledge	Active when SmartTest waits for confirmation during calibration: internal calibration: - transfer factors? external calibration: - test leak open and signal stable? - test leak closed and signal stable? - transfer factors?
21	Bypass Valve	Active when bypass valve is open (activation bypass option)
23	DGND (0 V)	Reference potential of the digital outputs, not galvanically isolated
22	No leak	Active when the alarm threshold is under-run
25	+24 V	+24 V e.g. for activating the digital inputs Fuse 0.8 A slow blow

Example of digital inputs:

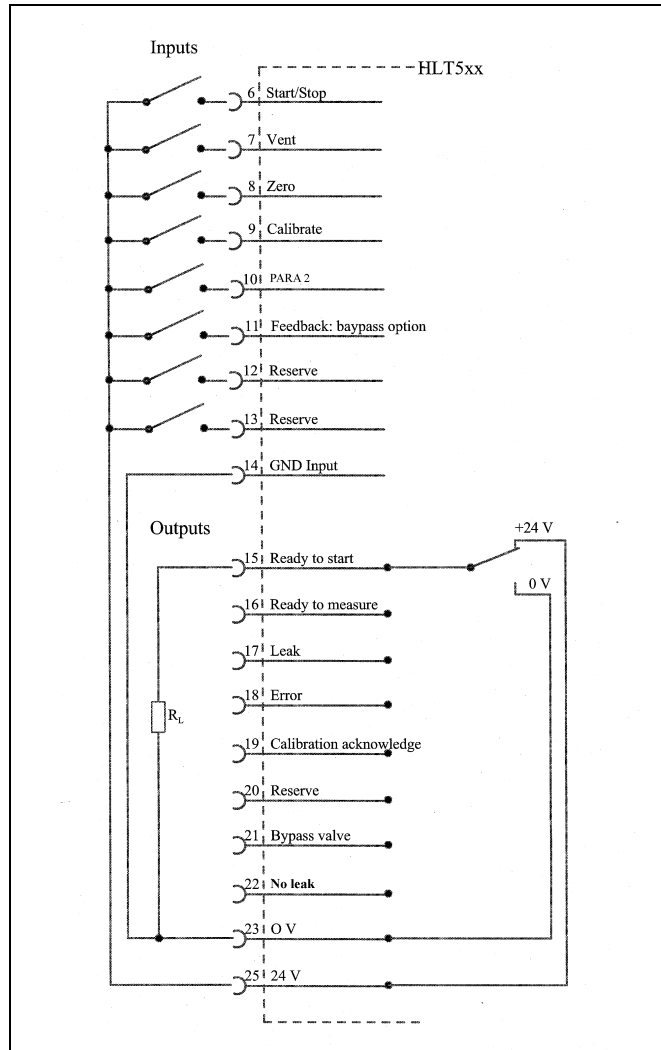

Fig. 10-5 Example of digital inputs

When accessing via +24V of the leak detector a connection between PIN14 and PIN23 has to exist.

Remote control

The remote control interface is designed as a serial interface for controlling the SmartTest by remote control, if the wired version is used. The remote control can be connected by a connecting cable with an RJ45 plug (Fig. 10-2/5). The remote control is not included in the normal scope of delivery of the SmartTest.

Pin	Signal
2	+24 V (fuse 0.8 A slow blow)
3	0 V DGND (0 V)
4	RxD (internal RS232)
5	TxD (internal RS232)

The connection of the SmartTest to a computer can be made through the serial interface RS485.

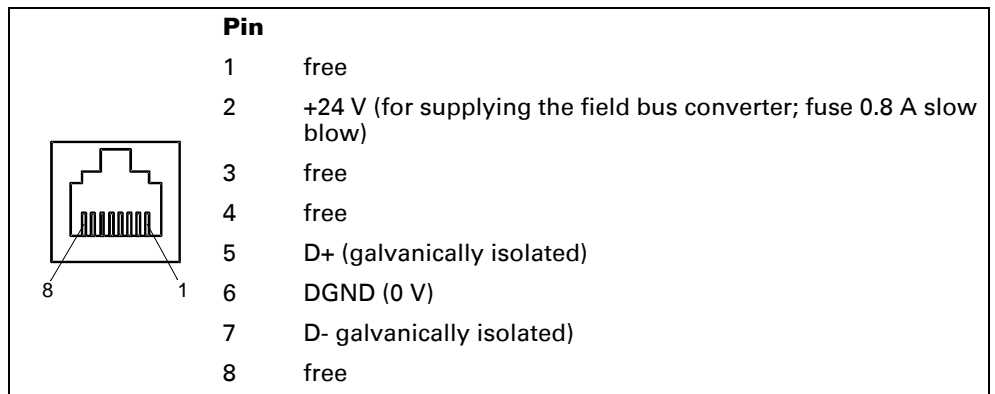

Fig. 10-6

Plug: RS485 (8-pole)

See also [Fig. 10-2/4](#).

- PIN 1 free
- PIN 2 +24 V (for supplying the field bus converter; fuse 0.8 A slow blow)
- PIN 3 free
- PIN 4 free
- PIN 5 D+ (galvanically isolated)
- PIN 6 DGND (0 V)
- PIN 7 D- (galvanically isolated)
- PIN 8 free



Note

Connector probably will not work if you do change this connector with the connector "LP".

With the RS485 interface up to 32 instruments can be connected with each other by two lines whereby never more than one instrument may transmit at once.

RS232

Connection for computer 9-pole, D-Sub sockets, RS232 (option RS485)

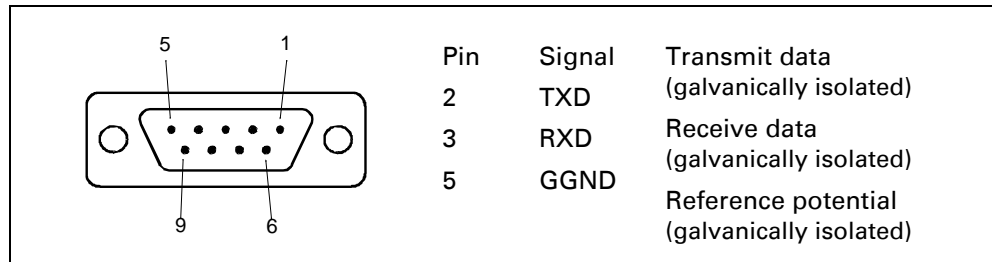

Fig. 10-7 RS232 interface

See RS232 Fig. 10-2/3.

Relay 1, Relay 2

Relay contact 230 V~, 3 A

Plug SmartTest Power Subcon, 3-pole

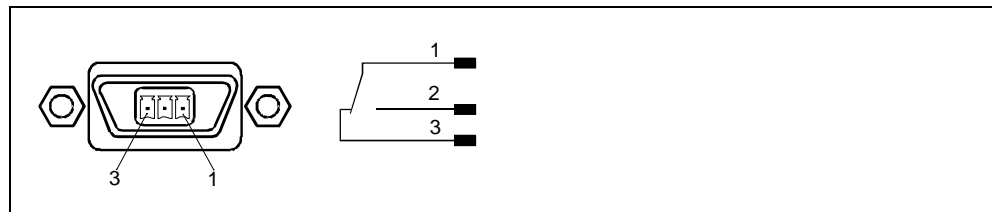

Fig. 10-8

See Fig. 10-2/6 or Fig. 10-2/7.

LP

Connection for sniffing probe LP 503, LP 505, LP 510

RJ-45, 8-pole

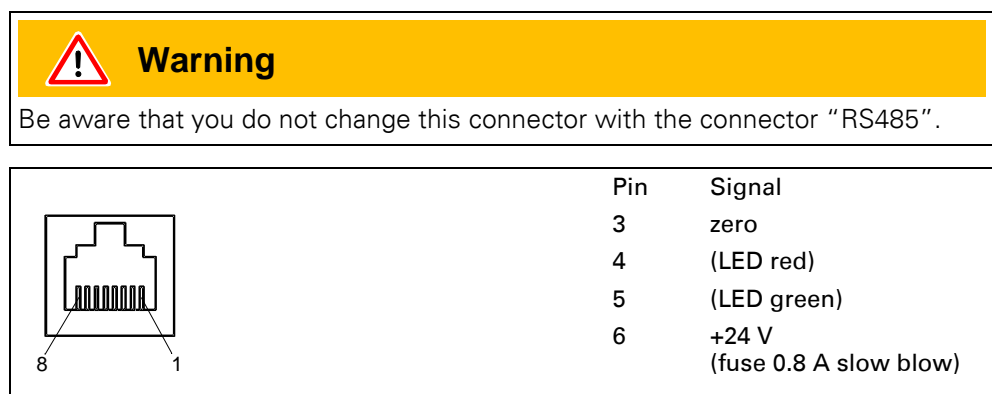

Fig. 10-9

LED green: Leak detector ready for measurement.

LED red: Threshold exceeded.

See Fig. 10-2/8.

C List of Default Values

Parameter	Default Values	Setting back to VORGABEWERT when loading default values	Included in set of parameters
contrast	50	no	no
invert display	off	yes	yes
leak rate unit	mbar l/s	yes	yes
pressure unit	mbar	yes	yes
scaling	log	yes	yes
decades at scaling log.	4	yes	yes
display unit	automatic	yes	yes
time axis	32 Seconds	yes	yes
lower display limit	1E-12mbar l/s	yes	yes
background in ready to start	on	yes	yes
menu PIN	0	yes	no
instrument PIN	0	yes	no
calibration enabled	on	yes	yes
language	English	yes	no
mode	Vacuum	yes	yes
mass	Masse 4	yes	yes
leak rate factor	Gas	yes	no
leak rate filter	dynamic	yes	yes
zero	enabled	yes	yes
time for start after zero	10 Seconds	yes	yes
BG subtraction at START	on	yes	yes
alarm mode	Trigger Alarm	yes	yes
alarm delay	30 Seconds	yes	yes
LR setpoint value	1E-4 mbar l/s	yes	yes
warning limit	100%	yes	yes
analog output channel 1	LR mantissa	yes	yes
analog output channel 2	LR exponent	yes	yes
analog scaling (upper limit)	-5	yes	no
analog scaling (V/decade)	1V per decade	yes	no

Parameter	Default Values	Setting back to VORGABEWERT when loading default values	Included in set of parameters
full scale (lin. gauge head)	1000 mbar	yes	no
setpoint value for ext. gauge heads	1E-1 mbar	yes	no
pressure P2 source	internal	no	no
control location	local, RS232/RS485	yes	yes
mode relay 1	off	yes	no
mode relay 2	off	yes	no
interface	RS232	yes	no
serial port	Pfeiffer	yes	yes
bypass modus	no bypass	yes	yes
venting delay internal	off	yes	yes
flow max.	50sccm	yes	yes
flow min.	10sccm	yes	yes
contamination protection	off	yes	yes
limit contamination protection	1E-3 mbar l/s	yes	yes
minimum volume	0	yes	yes
volume	2	yes	yes
TwinFlow high	set free	yes	yes
Change over threshold TwinFlow high	0,5mbar	yes	yes
TwinFlow low	set free	yes	yes
Change over threshold TwinFlow low	5 mbar	yes	yes
counterflow	set free	yes	yes
Change over threshold counterflow	15 mbar	yes	yes
maximum evacuation time	30 minutes	yes	yes
venting	with stop	yes	yes
calibratoin request	off	yes	yes
int. test leak	1E-6 mbar l/s	no	no
ext. test leak (vacuum)	1E-7 mbar l/s	yes	yes
ext. test leak (sniffing)	1E-5 mbar l/s	yes	yes
calibration mode	int. auto	yes	yes

D Pirani-Characteristic

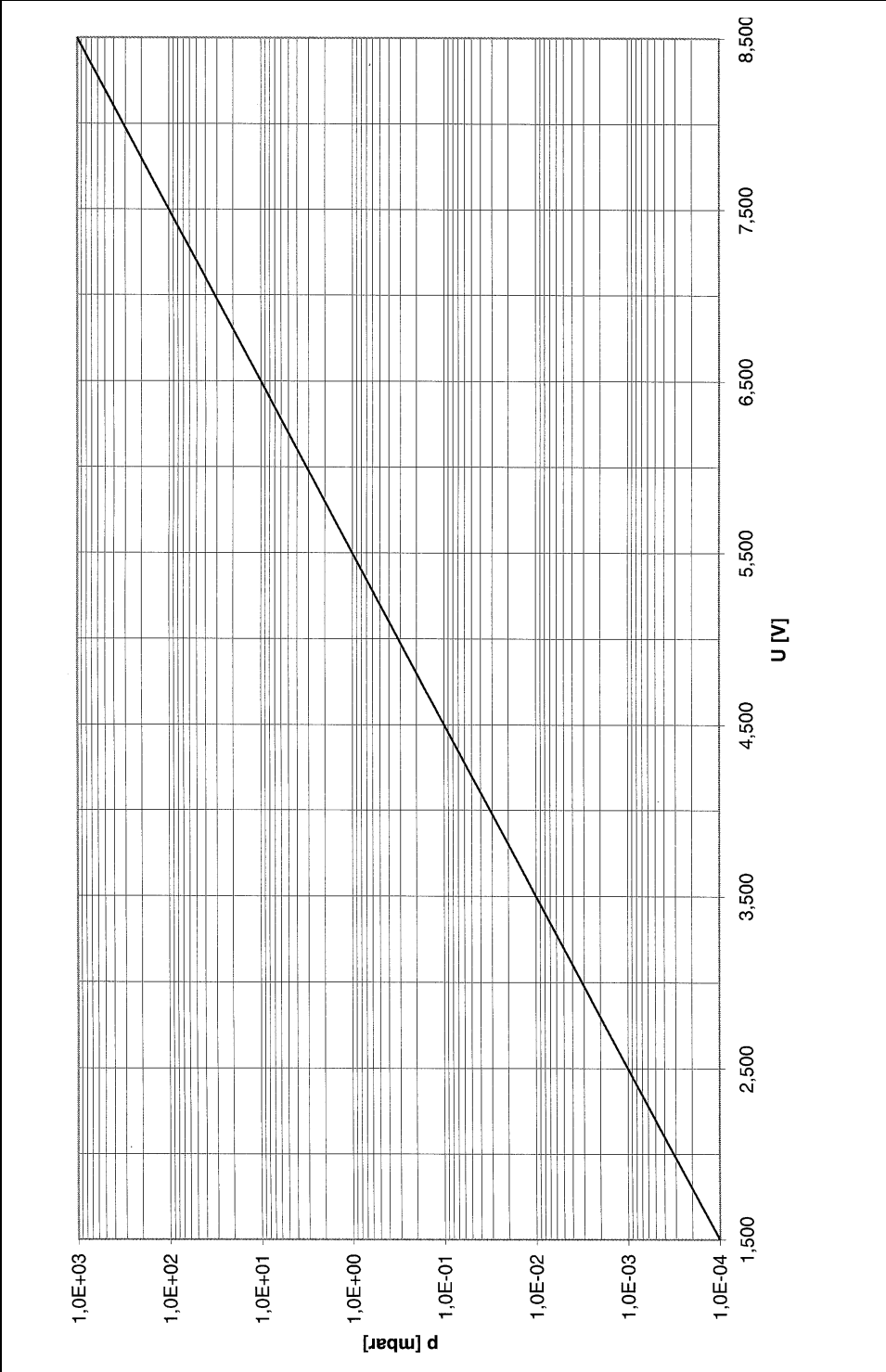

Fig. 10-10

E **List of literature**

Operating manual
Sniffer Probe LP 503, LP 505, LP 510
BG 805 268 BEN

Operating manual
Bypass-Option
PL0002 BN

Operating manual Cart for SmartTest
IG 0110 BEN

Communication Protocol SmartTest
IG 0105 BEN

Maintenance Instructions SmartTest
IG 0108 BEN

Operating instructions RC 500 WL / RC 500
IG 0140 BEN

F **Declaration of Contamination**



Warning

Products returned to Pfeiffer Vacuum for service or repair must be free of harmful substances (e.g. radioactive, toxic, caustic or microbiological).

Forwarding contaminated products:

- Adhere to the forwarding regulations of all involved countries and forwarder companies.
- Enclose a completed Declaration of Contamination.
- Declare all dangers on the package.

Products which are not clearly declared as "free from potentially harmful substances" will be decontaminated at the expense of the customer.

Fill in the form Declaration of Contamination before you ship a product to Pfeiffer Vacuum and enclose it to the shipment.

You can download the form on:

<http://www.pfeiffer-vacuum.net> from the Service-site.

G Declaration of Conformity

Declaration of Conformity

Product

SmartTest

Helium Leak Detector

HLT 550
HLT 560
HLT 570

Art.-No.

PT L02 100
PT L02 101
PT L02 102

PT L02 110
PT L02 111
PT L02 112

PT L02 120

Declaration of Conformity in accordance with the listed EC directives

We herewith declare that the aforementioned products confirm to the regulations in the subsequently listed guidelines.

The authorised representative for the arrangement of the technical documents is Andreas Schopphoff, Pfeiffer Vacuum GmbH, Berliner Str. 43, 35614 Asslar

- **Directive on Electromagnetic Compatibility (2004/108/EC)**
- **Directive on Machinery (2006/42/EC)**

Applied harmonized standards:

EN 61010-1 : 2001
EN 61000-6-4 : 2007 Part EN 55011 Class B
EN 61000-6-3 : 2007 Part EN 61000-3-2
EN 61000-6-2 : 2005 Parts EN 61000-4-2
EN 61000-4-3
EN 61000-4-4
EN 61000-4-5
EN 61000-4-6
EN 61000-4-11
DIN EN ISO 12100-1 / DIN EN ISO 12100-2

Signatures

Asslar, 16th of April 2010



Manfred Bender
Managing Director



Dr. Matthias Wiemer
Managing Director

Pfeiffer Vacuum GmbH
Berliner Str. 43, 35614 Asslar

**Leading. Dependable.
Customer Friendly.**

Pfeiffer Vacuum stands for innovative and custom vacuum solutions worldwide. For German engineering art, competent advice and reliable services.

Ever since the invention of the turbopump, we've been setting standards in our industry. And this claim to leadership will continue to drive us in the future.

**You are looking for a
perfect vacuum solution?
Please contact us:**

Germany

Pfeiffer Vacuum GmbH
Headquarters
Tel. +49 (0) 6441 802-0
info@pfeiffer-vacuum.de

Benelux

Pfeiffer Vacuum GmbH
Sales & Service Benelux
Tel.: +800-pfeiffer
benelux@pfeiffer-vacuum.de

China

Pfeiffer Vacuum
(Shanghai) Co., Ltd.
Tel.: +86 21 3393 3940
info@pfeiffer-vacuum.cn

France

Pfeiffer Vacuum France SAS
Tel.: +33 169 30 92 82
info@pfeiffer-vacuum.fr

Great Britain

Pfeiffer Vacuum Ltd.
Tel.: +44 1908 500600
sales@pfeiffer-vacuum.co.uk

India

Pfeiffer Vacuum India Ltd.
Tel.: +91 40 2775 0014
pfeiffer@vsnl.net

Italy

Pfeiffer Vacuum Italia S.p.A.
Tel.: +39 02 93 99 05 1
contact@pfeiffer-vacuum.it

Korea

Pfeiffer Vacuum Korea Ltd.
Tel.: +82 31 266 0741
sales@pfeiffer-vacuum.co.kr

Austria

Pfeiffer Vacuum Austria GmbH
Tel.: +43 1 894 17 04
office@pfeiffer-vacuum.at

Sweden

Pfeiffer Vacuum Scandinavia AB
Tel.: +46 8 590 748 10
sales@pfeiffer-vacuum.se

Switzerland

Pfeiffer Vacuum (Schweiz) AG
Tel.: +41 44 444 22 55
info@pfeiffer-vacuum.ch

United States

Pfeiffer Vacuum Inc.
Tel.: +1 603 578 6500
contact@pfeiffer-vacuum.com